

**Technical Protocol for Implementing Intrinsic
Remediation with Long-Term Monitoring for
Natural Attenuation of Fuel Contamination
Dissolved in Groundwater**

Volume II

By

Todd Wiedemeier

Parsons Engineering Science, Inc.
Denver, Colorado

John T. Wilson and Donald H. Kampbell

U.S. Environmental Protection Agency
Robert S. Kerr Laboratory
Ada, Oklahoma

Ross N. Miller and Jerry E. Hansen

Air Force Center for Environmental Excellence
Technology Transfer Division
Brooks AFB, San Antonio, Texas

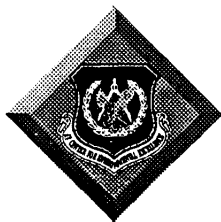

**Air Force Center for Environmental Excellence
Technology Transfer Division
Brooks AFB, San Antonio, Texas**

TECHNICAL PROTOCOL FOR IMPLEMENTING INTRINSIC REMEDIATION
WITH LONG-TERM MONITORING FOR
NATURAL ATTENUATION OF FUEL CONTAMINATION
DISSOLVED IN GROUNDWATER

VOLUME II

by

Todd H. Wiedemeier
Parsons Engineering Science, Inc.
Denver, Colorado

Dr. John T. Wilson and Dr. Donald H. Kampbell
United States Environmental Protection Agency*
National Risk Management Research Laboratory
Subsurface Protection and Remediation Division
Ada, Oklahoma

Lt. Col. Ross N. Miller and Jerry E. Hansen
Air Force Center for Environmental Excellence
Technology Transfer Division
Brooks Air Force Base, Texas

for

Air Force Center for Environmental Excellence
Technology Transfer Division
Brooks Air Force Base
San Antonio, Texas

*This United States Air Force guidance was developed in cooperation with United States Environmental Protection Agency(USEPA) researchers but was not issued by the USEPA and does not represent USEPA guidance.

This report is a work prepared for the United States Government by Parsons Engineering Science, Inc. and representatives from the United States Environmental Protection Agency. In no event shall either the United States Government or Parsons Engineering Science, Inc. have any responsibility or liability for any consequences of any use, misuse, inability to use, or reliance upon the information contained herein, nor does either warrant or otherwise represent in any way the accuracy, adequacy, efficacy, or applicability of the contents hereof.

DOCUMENT ORGANIZATION

VOLUME I

Section 1: Introduction

Section 2: Protocol For Implementing Intrinsic Remediation

Section 3: References

Appendix A: Site Characterization in Support of Intrinsic Remediation

Appendix B: Importance Processes Affecting the Fate and Transport of Fuel Hydrocarbons in the Subsurface

Appendix C: Data Interpretation and Calculations

Appendix D: Modeling the Fate and Transport of Fuel Hydrocarbons Dissolved in Groundwater

VOLUME II

Appendix E: Intrinsic Remediation Demonstration at Hill Air Force Base, Utah

Appendix F: Intrinsic Remediation Demonstration at Patrick Air Force Base, Florida

VOLUME II
TABLE OF CONTENTS

- Appendix E: Intrinsic Remediation Demonstration at Hill Air Force Base, Utah
Appendix F: Intrinsic Remediation Demonstration at Patrick Air Force Base, Florida

ACKNOWLEDGMENTS

The authors would like to thank Mr. Doug Downey, Dr. Robert Edwards, Dr. Robert Taylor, Dr. Guy Sewell, Dr. Mary Randolph, Mr. Randall Ross, Dr. Hanadi Rifai, and Ms. E. Kinzie Gordon for their extensive and helpful reviews of this manuscript. Dr. Robert Edwards for his contributions to the analytical protocol presented in Table 2.1. Mr. Matt Swanson for his contribution to the sections on modeling. Kyle Cannon, R. Todd Herrington, Jeff Black, Dave Moutoux, Bill Crawford, Peter Guest, Leigh Benson, Mark Vesseley, Jeff Fetkenhour, John Hicks, Steve Ratzlaff, Michael Phelps, Don Malone, Tom Richardson, Saskia Hoffer, and Haiyan Liu for their efforts at making this project a success!

APPENDIX E

INTRINSIC REMEDIATION DEMONSTRATION AT

HILL AIR FORCE BASE

OGDEN, UTAH

INTRINSIC REMEDIATION
ENGINEERING EVALUATION/COST ANALYSIS

for

UST SITE 870

HILL AIR FORCE BASE

OGDEN, UTAH

June 1995

Prepared for:

AIR FORCE CENTER FOR ENVIRONMENTAL EXCELLENCE
BROOKS AIR FORCE BASE
SAN ANTONIO, TEXAS

AND

HILL AIR FORCE BASE
OGDEN, UTAH

Prepared by:

Parsons Engineering Science, Inc.
1700 Broadway, Suite 900
Denver, Colorado 80290

EXECUTIVE SUMMARY

This report presents the results of an engineering evaluation/cost analysis (EE/CA) performed by Parsons Engineering-Science, Inc. (Parsons ES) [formerly known as Engineering-Science, Inc. (ES)] at Hill Air Force Base, Utah to evaluate the use of intrinsic remediation (natural attenuation) with long-term monitoring as a remedial option for dissolved-phase benzene, toluene, ethylbenzene, and xylene (BTEX) contamination in the shallow saturated zone near underground storage tank (UST) Site 870. Soil and ground water contamination is known to occur at the site, with contamination being present in the dissolved and gaseous phases, and as light nonaqueous phase liquid (LNAPL). This study focused on the impact of dissolved-phase BTEX on the shallow ground water system at the site. Site history and the results of soil and ground water investigations conducted previously are also summarized in this report.

An important component of this study was to assess the potential for BTEX dissolved in ground water to migrate from UST Site 870 to potential receptors. The Bioplume II model was used to estimate the rate and direction of dissolved-phase BTEX movement through the shallow saturated zone under the influence of advection, dispersion, sorption, and biodegradation. Input parameters used for the Bioplume II model were obtained from existing site characterization data, supplemented with data collected by Parsons ES in conjunction with personnel from the United States Environmental Protection Agency Robert S. Kerr Environmental Research Laboratory. Chemical analysis of a single LNAPL sample suggests that LNAPL contamination at the site is weathered JP-4 jet fuel. Extensive site-specific data were used as model input. Model input parameters that were not measured at the site were estimated using reasonable literature values for hydrogeologic conditions similar to those found at the site.

The results of this study suggest that dissolved-phase BTEX contamination present in ground water at UST Site 870 poses no significant risk to human health or the environment in its present, or predicted future, concentration and distribution. It is therefore recommended that intrinsic remediation with long-term monitoring be implemented for dissolved-phase BTEX contamination found in ground water at this site. To reduce sources of continuing contamination, it is also recommended that mobile LNAPL recovery operations and bioventing activities currently underway at the site be continued.

To verify Bioplume II model predictions, it is recommended that nine long-term monitoring (LTM) wells, three point-of-compliance (POC) monitoring wells, and a contingency sampling

point at the mouth of the stormwater sewer that runs along Cambridge Street be used to monitor the long-term migration and degradation of the dissolved-phase BTEX plume. Regular sampling and analysis of water from these sampling locations will allow the effectiveness of intrinsic remediation to be monitored and should allow sufficient time to implement hydraulic controls to contain the plume if BTEX is detected at the POC sampling locations. The LTM wells and POC sampling locations should be sampled on a semiannual basis for at least 13 years. If the data collected during this period supports the anticipated effectiveness of intrinsic remediation, the sampling frequency can be reduced to once every year, or eliminated. Ground water samples should be analyzed for the parameters described in Section 7 of this report. If BTEX concentrations in water from the POC sampling locations are found to exceed promulgated maximum contaminant levels, additional corrective actions should be taken to remediate ground water at the site, as described in this report.

TABLE OF CONTENTS

EXECUTIVE SUMMARY	ES-1
1.0 INTRODUCTION	1-1
1.1 SCOPE AND OBJECTIVES	1-1
1.2 FACILITY BACKGROUND.....	1-3
1.2.1 Operational History.....	1-6
1.2.2 Current Remedial Activities.....	1-6
2.0 SITE CHARACTERIZATION ACTIVITIES	2-1
2.1 DRILLING, SOIL SAMPLING, AND MONITORING WELL INSTALLATION.....	2-2
2.1.1 Well Locations and Completion Intervals	2-3
2.1.2 Well Drilling and Installation Procedures.....	2-3
2.1.2.1 Pre-Drilling Activities	2-3
2.1.2.2 Equipment Decontamination Procedures.....	2-3
2.1.2.3 Drilling and Soil Sampling	2-7
2.1.2.4 Monitoring Well Installation	2-8
2.1.2.4.1 Well Materials Decontamination	2-8
2.1.2.4.2 Well Casing	2-9
2.1.2.4.3 Well Screen	2-9
2.1.2.4.4 Sand Filter Pack.....	2-9
2.1.2.4.5 Annular Sealant	2-9
2.1.2.4.6 Flush-Mount Protective Cover.....	2-10
2.1.2.5 Well Development	2-10
2.1.2.6 Water Level Measurements	2-10
2.1.2.7 Well Location and Datum Survey	2-11
2.2 GROUND WATER SAMPLING	2-11
2.2.1 Ground Water Sampling Locations.....	2-12
2.2.1.1 Geoprobe® Sampling Locations.....	2-12
2.2.1.2 Monitoring Well Sampling Locations.....	2-13
2.2.1.3 Storm Sewer Sampling Locations	2-13
2.2.2 Preparation for Sampling.....	2-13
2.2.2.1 Equipment Cleaning	2-13
2.2.2.2 Equipment Calibration.....	2-13
2.2.3 Sampling Procedures.....	2-14
2.2.3.1 Geoprobe® Ground Water Sampling	2-14
2.2.3.1.1 Sampling Interval and Method	2-14

2.2.3.1.2	Preparation of Location	2-16
2.2.3.1.3	Water Level and Total Depth Measurements.....	2-16
2.2.3.1.4	Sample Extraction.....	2-16
2.2.3.1.5	Geoprobe® Equipment Decontamination.....	2-16
2.2.3.2	Ground Water Monitoring Well Sampling.....	2-17
2.2.3.2.1	Preparation of Location	2-17
2.2.3.2.2	Water Level and Total Depth Measurements.....	2-17
2.2.3.2.3	Well Bore Purging	2-17
2.2.3.2.4	Sample Extraction.....	2-17
2.2.3.3	Storm Sewer Sampling	2-18
2.2.4	Onsite Chemical Parameter Measurement.....	2-18
2.2.4.1	Dissolved Oxygen Measurements	2-18
2.2.4.2	Reduction/Oxidation Potential Measurements.....	2-18
2.2.4.3	pH, Temperature, and Specific Conductance.....	2-18
2.2.5	Sample Handling	2-19
2.2.5.1	Sample Preservation	2-19
2.2.5.2	Sample Container and Labels.....	2-19
2.2.5.3	Sample Shipment.....	2-20
2.3	AQUIFER TESTING	2-20
2.3.1	Slug Testing.....	2-20
2.3.1	Slug Test Data Analysis	2-21
2.4	SURVEYING.....	2-21
3.0	PHYSICAL CHARACTERISTICS OF THE STUDY AREA	3-1
3.1	SURFACE FEATURES	3-1
3.1.1	Topography and Surface Water Hydrology.....	3-1
3.1.2	Manmade Features	3-1
3.2	REGIONAL GEOLOGY AND HYDROGEOLOGY	3-3
3.3	SITE GEOLOGY AND HYDROGEOLOGY.....	3-3
3.3.1	Lithology and Stratigraphic Relationships.....	3-4
3.3.2	Grain Size Distribution.....	3-4
3.3.3	Ground Water Hydraulics.....	3-8
3.3.3.1	Flow Direction and Gradient.....	3-8
3.3.3.2	Hydraulic Conductivity (K).....	3-8
3.3.3.3	Effective Porosity (n_e)	3-10
3.3.3.4	Advective Ground Water Velocity (\bar{v})	3-10
3.3.3.5	Preferential Flow Paths.....	3-11
3.3.5	Ground Water Use	3-11
3.4	CLIMATOLOGICAL CHARACTERISTICS.....	3-12

4.0 NATURE AND EXTENT OF CONTAMINATION AND SOIL AND GROUND WATER GEOCHEMISTRY	4-1
4.1 SOURCE OF CONTAMINATION	4-1
4.2 SOIL CHEMISTRY	4-1
4.2.1 Mobile LNAPL Contamination.....	4-1
4.2.2 Residual-Phase (Stationary) LNAPL Contamination.....	4-4
4.2.2.1 Soil BTEX Contamination.....	4-4
4.2.2.2 Soil TPH Contamination.....	4-4
4.2.3 Total Organic Carbon.....	4-12
4.3 GROUND WATER CHEMISTRY.....	4-13
4.3.1 Dissolved-Phase BTEX Contamination	4-13
4.3.2 Inorganic Chemistry and Geochemical Indicators of Biodegradation.....	4-21
4.3.2.1 Dissolved Oxygen.....	4-21
4.3.2.2 Nitrate/Nitrite.....	4-27
4.3.2.3 Ferrous Iron	4-30
4.3.2.4 Sulfate.....	4-33
4.3.2.5 Methane	4-37
4.3.2.6 Reduction/Oxidation Potential	4-40
4.3.2.7 Alkalinity.....	4-40
4.3.2.8 pH.....	4-43
4.3.2.9 Temperature.....	4-43
4.3.3 Expressed Assimilative Capacity.....	4-43
5.0 GROUND WATER MODEL.....	5-1
5.1 GENERAL OVERVIEW AND MODEL DESCRIPTION.....	5-1
5.2 CONCEPTUAL MODEL DESIGN AND ASSUMPTIONS	5-2
5.4 MODEL INPUT.....	5-3
5.4.1 Grid Design.....	5-3
5.4.2 Ground Water Elevation and Gradient.....	5-6
5.4.3 BTEX Concentrations	5-6
5.4.4 Hydraulic Conductivity.....	5-8
5.4.5 Electron Acceptors (Oxygen and Nitrate).....	5-8
5.4.5 Dispersivity	5-12
5.4.6 Retardation	5-12
5.4.7 Reaeration.....	5-14
5.5 MODEL CALIBRATION	5-14
5.5.1 Water Table Calibration	5-14
5.5.2 BTEX Plume Calibration.....	5-16
5.6 SENSITIVITY ANALYSIS	5-18

5.7	MODEL RESULTS.....	5-23
5.7.1	No Source Removal (Model Hill-A).....	5-24
5.7.2	Five-Percent Annual Source Removal (Model Hill-B).....	5-24
5.7.3	Fifteen-Percent Annual Source Removal (Model Hill-C).....	5-27
5.9	CONCLUSIONS.....	5-33
6.0	COMPARATIVE ANALYSIS OF REMEDIAL ALTERNATIVES.....	6-1
6.1	REMEDIAL ALTERNATIVE EVALUATION CRITERIA.....	6-1
6.1.1	Long-Term Effectiveness and Permanence.....	6-1
6.1.2	Implementability.....	6-2
6.1.3	Cost.....	6-2
6.2	FACTORS INFLUENCING ALTERNATIVES DEVELOPMENT.....	6-2
6.2.1	Program Objectives.....	6-3
6.2.2	Contaminant Properties.....	6-3
6.2.3	Site-Specific Conditions.....	6-5
6.2.3.1	Ground Water and Soil Characteristics.....	6-5
6.2.3.2	Potential Exposure Pathways.....	6-7
6.2.3.3	Remediation Goals for Shallow Ground Water.....	6-9
6.2.4	Summary of Remedial Technology Screening.....	6-10
6.3	BRIEF DESCRIPTION OF REMEDIAL ALTERNATIVES.....	6-15
6.3.1	Alternative 1 - Continued Mobile LNAPL Removal and Bioventing in Source Area, Intrinsic Remediation, Institutional Controls with Long-Term Monitoring.....	6-15
6.3.2	Alternative 2 - Continued Mobile LNAPL Recovery and Bioventing, Intrinsic Remediation, Institutional Controls with Long-term Ground Water Monitoring, Stormwater Treatment.....	6-17
6.3.3	Alternative 3 - Expanded Mobile LNAPL Removal and Bioventing, Intrinsic Remediation, Institutional Controls and Long-Term Monitoring.....	6-18
6.4	EVALUATION OF ALTERNATIVES.....	6-20
6.4.1	Alternative 1 - Continued Mobile LNAPL Removal and Bioventing in Source Area, Intrinsic Remediation, Institutional Controls with Long-Term Monitoring.....	6-20
6.4.1.1	Effectiveness.....	6-20
6.4.1.2	Implementability.....	6-22
6.4.2	Alternative 2 - Continued Mobile LNAPL Recovery and Bioventing in Source Area, Intrinsic Remediation, Institutional Controls with Long-Term Ground Water Monitoring, Stormwater Treatment.....	6-23
6.4.2.1	Effectiveness.....	6-23

6.4.2.2 Implementability	6-24
6.4.2.3 Cost	6-24
6.4.3 Alternative 3 - Intensive Source Removal, Intrinsic Remediation, Institutional Controls and Long-Term Monitoring	6-25
6.4.3.1 Effectiveness	6-25
6.4.3.2 Implementability	6-27
6.4.3.3 Cost	6-27
6.5 RECOMMENDED REMEDIAL APPROACH.....	6-28
7.0 LONG-TERM MONITORING PLAN	7-1
7.1 OVERVIEW	7-1
7.2 MONITORING NETWORKS.....	7-1
7.2.1 Long-Term Monitoring Network.....	7-2
7.2.2 Point-of-Compliance Monitoring Network	7-4
7.3 GROUND WATER SAMPLING AND ANALYSIS	7-4
7.3.1 Analytical Protocol.....	7-5
7.3.1.1 Long-Term Monitoring Well Analytical Protocol.....	7-5
7.3.1.2 Point-Of-Compliance Monitoring Point Analytical Protocol.....	7-5
7.3.2 Frequency	7-5
8.0 CONCLUSIONS AND RECOMMENDATIONS	8-1
9.0 REFERENCES	9-1

APPENDICES

APPENDIX A	Boring Logs, Well Completion Diagrams, and Slug Test Results
APPENDIX B	Ground Water Elevation and LNAPL Thickness Data
APPENDIX C	Soil and Ground Water Analytical Results
APPENDIX D	Gridded Model Input and Water Table Calibration Results
APPENDIX E	Bioplume II Model Output

TABLES

No.	Title	Page
2.1	Well Completion Information.....	2-4
3.1	Slug Test Results	3-10
4.1	Comparative Fresh and Weathered LNAPL BTEX Analytical Results	4-3
4.2	Fuel Hydrocarbon Compounds Detected in Soil	4-5
4.3	Total Organic Carbon in Soil.....	4-12
4.4	Fuel Hydrocarbon Compounds Detected in Ground Water	4-14
4.5	Ground Water Geochemical Data.....	4-22
4.6	Expressed Assimilative Capacity of Site Ground Water	4-44
5.1	Bioplume II Model Input Parameters.....	5-4
5.2	Retardation Calculations for the BTEX Compounds.....	5-15
6.1	Point-Of-Compliance Remediation Goals	6-10
6.2	Initial Technical Implementability Screening of Technologies and Process Options for Ground Water Remediation	6-11
6.3	Alternative 1 - Cost Estimate	6-24
6.4	Alternative 2 - Cost Estimate	6-26
6.5	Alternative 3 - Cost Estimate	6-28
6.6	Summary of Remedial Alternative Evaluation.....	6-30
7.1	Long-Term Monitoring Analytical Protocol.....	7-6
7.2	Point-Of-Compliance Monitoring Analytical Protocol.....	7-8

FIGURES

No.	Title	Page
1.1	Regional Location Map	1-4
1.2	Site Map	1-5
2.1	Cross Section of Geoprobe	2-15
3.1	Storm Sewer Layout	3-2
3.2	Hydrogeologic Section Location Map	3-5
3.3	Hydrogeologic Section A-A'	3-6
3.4	Hydrogeologic Section B-B'	3-7
3.5	Ground Water Elevation Map, July/August 1993.....	3-9
4.1	LNAPL Isopach Map, July/August 1993	4-2

4.2	Total BTEX Isoleth for Soil.....	4-10
4.3	Total Petroleum Hydrocarbon Isoleth Map for Soil	4-11
4.4	Total BTEX Isoleth for Ground Water Through August 1993	4-19
4.5	Total BTEX Isoleth for Ground Water, July 1994	4-20
4.6	Dissolved Oxygen Isoleth For Ground Water, August 1993.....	4-24
4.7	Dissolved Oxygen Isoleth For Ground Water, July 1994.....	4-26
4.8	Nitrate + Nitrite Isoleth For Ground Water, August 1993.....	4-28
4.9	Nitrate + Nitrite Isoleth For Ground Water, July 1994.....	4-29
4.10	Ferrous Iron Isoleth For Ground Water, August 1993	4-31
4.11	Ferrous Iron Isoleth For Ground Water, July 1994	4-32
4.12	Sulfate Concentration in Ground Water, August 1993	4-34
4.13	Sulfate Isoleth Map Ground Water, July 1994	4-36
4.14	Methane Isoleth Map Ground Water, August 1993.....	4-38
4.15	Methane Isoleth Map Ground Water, July 1994.....	4-39
4.16	Reduction/Oxidation Potential Map, August 1993	4-41
4.17	Reduction/Oxidation Potential Map, July 1994	4-42
5.1	Model Grid Including Injection Cell Locations	5-5
5.2	Model Results, Total Dissolved BTEX, All Models, T=0 Year	5-7
5.3	Combined DO an Nitrate Isoleth Map, August 1993.....	5-13
5.4	Calibrated Water Table Elevation Map	5-17
5.5	Plot of Total BTEX versus Distance Along Plume Centerline with Varying Hydraulic Conductivity	5-20
5.6	Plot of Total BTEX versus Distance Along Plume Centerline with Varying Coefficient of Reaeration	5-21
5.7	Plot of Total BTEX versus Distance Along Plume Centerline with Varying Dispersivity.....	5-22
5.8	Model Results, Total Dissolved BTEX, No LNAPL Removal, T=1 year	5-25
5.9	Model Results, Total Dissolved BTEX, No LNAPL Removal, T=10 years.....	5-26
5.10	Model Results, Total Dissolved BTEX, 5% Annual LNAPL Removal, T=1 year	5-28
5.11	Model Results, Total Dissolved BTEX, 5% Annual LNAPL Removal, T=4 years.....	5-29
5.12	Model Results, Total Dissolved BTEX, 5% Annual LNAPL Removal, T=7 years.....	5-30
5.13	Model Results, Total Dissolved BTEX, 15% Annual LNAPL Removal, T=1 year	5-31
5.14	Model Results, Total Dissolved BTEX, 15% Annual LNAPL Removal, T=3 years.....	5-32
7.1	Proposed Long-Term Monitoring Well and Point-Of-Compliance Monitoring Well Placement	7-3

SECTION 1

INTRODUCTION

This report was prepared by Parsons PEngineering-Science, Inc. (Parsons ES) [formerly known as Engineering Science, Inc. (ES)] and presents the results of an engineering evaluation/cost analysis (EE/CA) conducted to evaluate the use of intrinsic remediation (natural attenuation) with long-term monitoring (LTM) for remediation of fuel-hydrocarbon contamination dissolved in ground water at underground storage tank (UST) Site 870, Hill Air Force Base (AFB), Utah. Previous investigations determined that JP-4 jet fuel had been released into the soil and shallow ground water at the site. The main emphasis of the work described herein was to evaluate the potential for intrinsic degradation mechanisms to reduce dissolved-phase benzene, toluene, ethylbenzene, and xylene (BTEX) concentrations in ground water to levels that are protective of human health and the environment.

1.1 SCOPE AND OBJECTIVES

Parsons ES, in conjunction with researchers from the United States Environmental Protection Agency (USEPA) Robert S. Kerr Environmental Research Laboratory (RSKERL), was retained by the United States Air Force Center for Environmental Excellence (AFCEE) to conduct site characterization and ground water modeling in support of intrinsic remediation with LTM at UST Site 870.

The scope of work for this project included the following tasks:

- Reviewing existing hydrogeologic and soil and ground water quality data for the site;
- Conducting supplemental site characterization activities to determine the nature and extent of soil and ground water contamination and to collect geochemical data to demonstrate the occurrence of intrinsic remediation;
- Developing a conceptual hydrogeologic model of the shallow saturated zone, including the distribution of contaminants and probable contaminant pathways;
- Determining if intrinsic processes of contaminant destruction are occurring in ground water at the site;

- Performing contaminant fate and transport modeling based on site hydrogeologic conditions using the Bioplume II model;
- Evaluating a range of model input parameters to determine the sensitivity of the model to these parameters and to consider several contaminant fate and transport scenarios;
- Determining if naturally-occurring processes are sufficient to minimize BTEX plume expansion so that ground water quality standards can be met at a downgradient point of compliance (POC);
- Conduct a preliminary exposure assessment for receptors potentially exposed to fuel hydrocarbon contamination in ground water;
- Developing remedial action objectives (RAOs) and reviewing available remedial technologies;
- Using the results of modeling to recommend the most appropriate remedial option based on specific effectiveness, implementability, and cost criteria; and
- Providing a LTM plan that includes LTM and POC well locations and a sampling and analysis plan (SAP).

Site characterization methods used to evaluate intrinsic remediation included Geoprobe[®] sampling of ground water near existing cone penetrometer testing locations, soil borehole drilling, soil sample collection and analysis, monitoring well installation, and sampling and analysis of ground water from newly installed and existing monitoring wells.

Site-specific data were used to develop a fate and transport model for the site using Bioplume II and to conduct a preliminary exposure assessment. The Bioplume II model was used to simulate the movement and degradation of BTEX in the shallow saturated zone under the influence of advection, dispersion, sorption, and biodegradation. As part of the EE/CA, this modeling effort had three primary objectives: 1) to predict the future extent and concentration of a dissolved-phase contaminant plume by modeling the combined effects of advection, dispersion, sorption, and biodegradation; 2) to assess the possible risk to potential downgradient receptors by conducting a preliminary exposure assessment; and 3) to provide technical support for the intrinsic remediation with LTM remedial option at regulatory negotiations, as appropriate.

Several remedial options were evaluated as part of this EE/CA, including light nonaqueous-phase liquid (LNAPL) removal; soil vapor extraction; bioventing, hydraulic containment; and intrinsic remediation with LTM. Hydrogeologic and ground water chemical data necessary to evaluate the various remedial options were collected under this program; however, field work was designed to collect the data required by the Bioplume II model and to support the intrinsic

remediation with LTM remedial option for restoration of fuel-hydrocarbon-contaminated ground water.

This report contains nine sections, including this introduction, and five appendices. Section 2 summarizes site characterization activities. Section 3 summarizes the physical characteristics of the study area. Section 4 describes the nature and extent of soil and ground water contamination and the geochemistry of soil and ground water at the site. Section 5 describes the Bioplume II model, the site conceptual model, lists model assumptions and input parameters, and describes sensitivity analyses, model output, and the results of the Bioplume II simulations. Section 6 presents a comparative analysis of remedial alternatives. Section 7 presents the LTM plan for the site. Section 8 presents the conclusions of this investigation and provides recommendations for further work at the site. Section 9 lists the references used to develop this document. Appendix A contains boring logs, monitoring well completion diagrams, and slug test results. Appendix B contains ground water elevation data and information on the seasonal variation in ground water flow at the site. Appendix C presents soil and ground water analytical results. Appendix D contains gridded model input parameters and water table calibration results. Appendix E contains Bioplume II model output on a diskette in ASCII format.

1.2 FACILITY BACKGROUND

Hill AFB is located at 41°07'N latitude, 111°58'W longitude on a bench of the Wasatch Mountains on the edge of the Great Salt Lake Basin. UST Site 870 is located in the southwestern corner of Hill AFB, Utah. Figure 1.1 is a regional location map showing the location of UST Site 870 relative to Hill AFB and the surrounding area. Figure 1.2 is a detailed site map showing UST Site 870 and the immediately adjacent area. UST Site 870 encompasses the area immediately downgradient from and adjacent to the former location of UST 870.0. This site is referred to as Site EGSS by the Utah Division of Environmental Response and Remediation (DERR), and as Site Code ST61 under the Air Force Installation Restoration Program (IRP). For the purposes of the work described herein, UST Site 870 refers to the area shown in Figure 1.2. This area includes the base fuel tank farm which consists of nine aboveground storage tanks (ASTs) used to store JP-4 and diesel fuel. A portion of the Patriot Hills base housing area located southwest of the AST farm, is also included with the site.

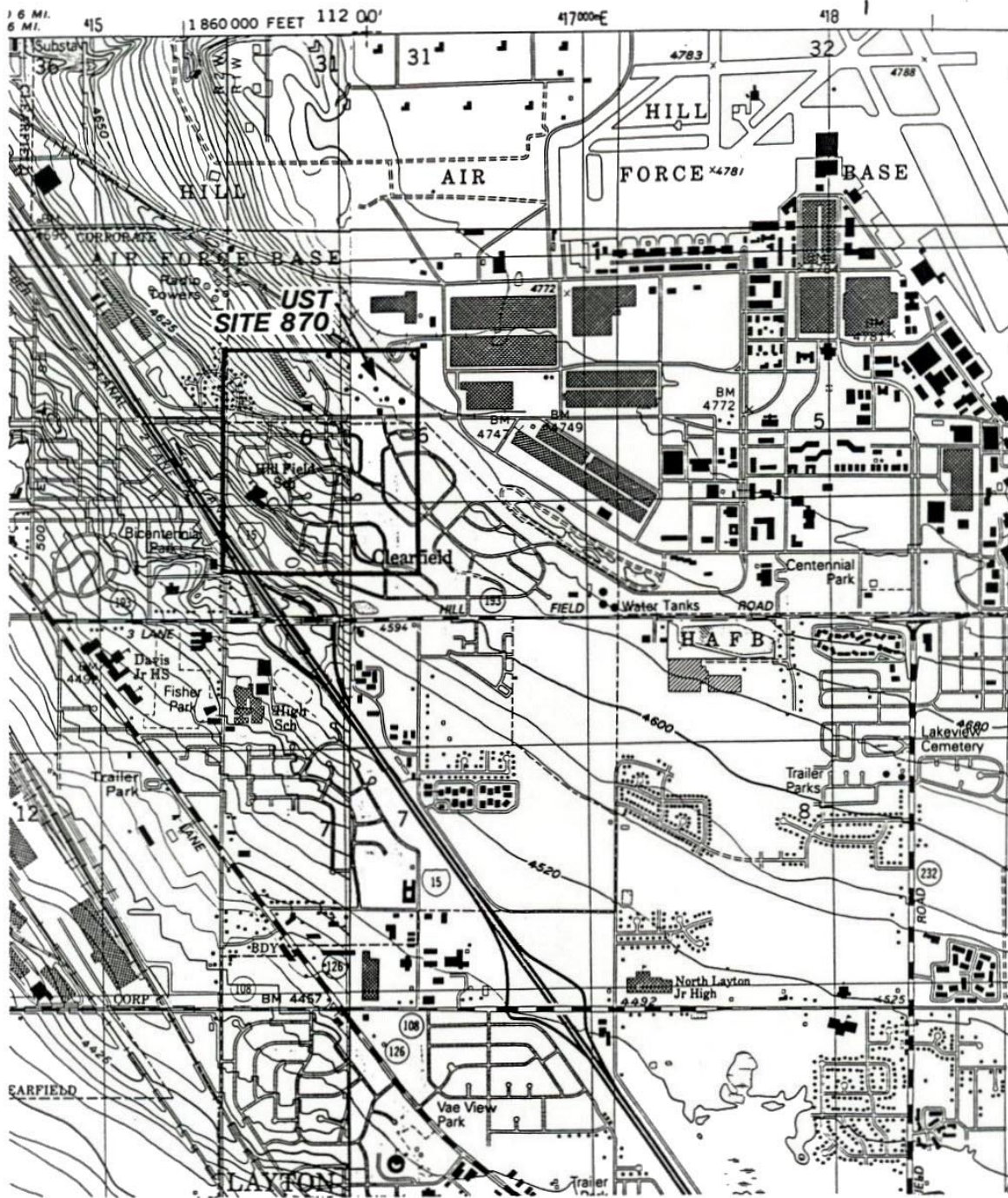

LEGEND
SCALE
 1: 24,000

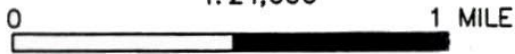

Contour Interval = 5 feet for left 1/3; 40 feet for right 2/3

SOURCE: U.S.G.S. 7.5 Minute Quadrangle Maps: Clearfield, Utah (1991) and Kaysville, Utah (1992) Quadrangles.

FIGURE 1.1
REGIONAL LOCATION MAP
 UST Site 870
 Intrinsic Remediation EE/CA
 Hill Air Force Base, Utah

PARSONS
ENGINEERING SCIENCE, INC.
 Denver, Colorado

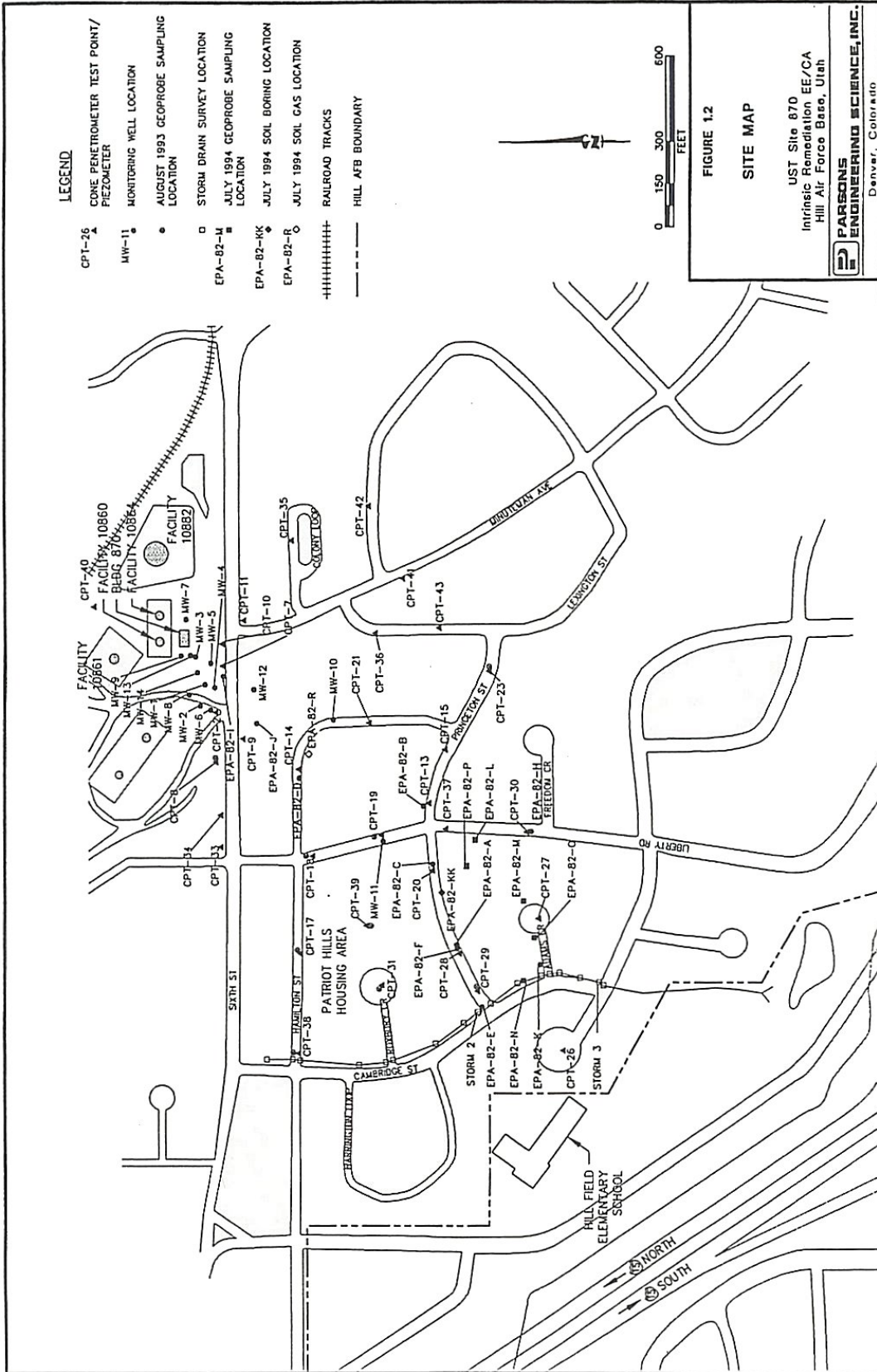

1.2.1 Operational History

UST Site 870 is located at one of the base fuel tank farms. This tank farm is bounded on the south by Sixth Street and the Patriot Hills housing area (Figure 1.2). Building 870 at the tank farm serves as the command and logistical support center for the dispensing of JP-4 to the flightlines. Several ASTs are located directly north of Building 870. The Patriot Hills housing area consists of military residential housing. Warehouses, offices, and other large structures are located east and west of the tank farm. Hill Field elementary school is located immediately southwest of the housing area near the base's southwestern property boundary.

UST 870.0 was a 1,000-gallon tank used to store condensate and off-specification JP-4 generated by activities at an adjacent filter stand. UST 870.0 was excavated and removed in May 1991 and upgraded with a new double-walled steel UST equipped with leak-detection equipment. The new UST serves the same purpose as UST 870.0.

Soil and ground water contamination was observed during removal of UST 870.0. Several site investigations were conducted by Montgomery-Watson, Inc. (MWI) [formerly James M. Montgomery Consulting Engineers, Inc. (JMM)] in response to this contamination. The results of these investigations are presented in several reports, including:

- Site Characterization Report (JMM, 1991)
- Free Product Letter Report (JMM, 1992a)
- Pumping Tests and Product Thickness Test Letter Report (JMM, 1992b)
- Remedial Options Letter Report (JMM, 1993a)
- Investigation Summary Report (JMM, 1993b)

The site-specific data presented in Sections 3, 4, and 5 are based on a review of these documents and on data collected by Parsons ES and researchers from the RSKERL under this program. A synopsis of site characterization activities conducted prior to implementation of the field work described in this report is provided in the 1993 Investigation Summary Report prepared by JMM (1993b).

1.2.2 Current Remedial Activities

Current remedial activities at UST Site 870 include active and passive light non-aqueous phase liquid (LNAPL) recovery. Active mobile-phase LNAPL recovery is being accomplished using a QED[®] specific-gravity skimmer pump installed in a monitoring well and has been conducted since June 1992. Passive LNAPL recovery is also being performed in selected wells by using Soak Ease[®] absorbent pads enclosed in a stainless steel perforated bailer. To date, about 700 gallons of LNAPL has been recovered using these systems. Water and LNAPL levels are measured monthly to provide information about LNAPL thickness and ground water level fluctuations.

SECTION 2

SITE CHARACTERIZATION ACTIVITIES

To meet the requirements of the intrinsic remediation demonstration, several investigative techniques, including soil and ground water sampling and aquifer testing, were utilized. Soil sampling was accomplished during this investigation using modified hollow-stem auger (HSA) drilling in conjunction with continuous solid-barrel sampling. Previous investigations conducted at the site utilized standard HSA drilling and soil sampling as well as cone penetrometer testing (CPT). Geoprobe[®] sampling apparatus and newly installed and previously existing monitoring wells were used to collect ground water samples during this investigation. Previous investigations utilized monitoring wells installed in HSA boreholes and monitoring points installed in CPT holes to sample ground water. Aquifer tests conducted at the site included pumping and slug testing.

This section presents the methods used by Parsons ES and researchers from the RSKERL to collect site-specific data at Hill AFB, Utah. Site characterization data obtained under this program were collected in four phases. Phase one consisted of collecting shallow ground water samples using a Geoprobe[®]. Phase two consisted of continuous soil boring and sampling, ground water monitoring well installation and sampling, and aquifer testing. Phase three consisted of collecting ground water samples from existing monitoring wells. Phase four consisted of continuous soil boring and sampling, ground water monitoring well installation and sampling, and ground water sampling using a Geoprobe[®]. In addition to the work conducted under this program, MWI collected soil and ground water data on numerous occasions (JMM, 1993b; MWI, MWI, 1994a; MWI, 1994b). Data collected under this program and data collected by MWI were integrated to develop the conceptual site model and to aid interpretation of the physical setting (Section 3) and contaminant distribution (Section 4).

The physical and chemical hydrogeologic data listed below were collected during the field work phase of the EE/CA:

- Depth from measurement datum to the water table or potentiometric surface in monitoring wells and monitoring points;

- Depth from measurement datum to the base of the shallow saturated zone;
- Location of potential ground water recharge and discharge areas;
- Hydraulic conductivity as determined from slug test data;
- Detailed stratigraphic analysis of subsurface media;
- Estimation of extent and thickness of mobile-phase LNAPL;
- Dissolved oxygen, nitrate, ferrous iron, sulfate, methane, chloride, ammonia, and total organic carbon (TOC) concentrations in ground water;
- Temperature, specific conductance, reduction/oxidation (redox) potential, total alkalinity, and pH of ground water;
- BTEX, trimethylbenzene, and total petroleum hydrocarbon (TPH) concentrations in ground water;
- BTEX, trimethylbenzene, and TPH concentrations in soil;
- TOC concentrations in select soil samples; and
- Chemical analysis of free product to determine the mass fraction of BTEX;

The following sections describe the procedures followed when collecting site-specific data. The applied drilling, soil sampling, lithologic logging, and monitoring well development procedures are described in Section 2.1. Ground water sampling procedures are described in Section 2.2. Aquifer testing procedures are described in Section 2.3.

2.1 DRILLING, SOIL SAMPLING, AND MONITORING WELL INSTALLATION

Drilling, soil sampling, and monitoring well installation were accomplished in two phases under this program. Phase one occurred during the week of 16 August 1993, and consisted of drilling, soil sampling, and monitoring well installation at EPA-82-A, EPA-82-B, EPA-82-C, EPA-82-D, EPA-82-E, EPA-82-F, EPA-82-H, and EPA-82-I. Phase two occurred during the week of 4 July 1994, and consisted of drilling and soil sampling at EPA-82-J and EPA-82-KK, and monitoring well installation at EPA-82-J. Drilling, soil sampling, and monitoring well installation were accomplished using the procedures described in the following sections.

2.1.1 Well Locations and Completion Intervals

Nine new ground water monitoring wells were installed to help characterize the shallow ground water flow system UST Site 870. These wells are identified as EPA-82-A, EPA-82-B, EPA-82-C, EPA-82-D, EPA-82-E, EPA-82-F, EPA-82-H, EPA-82-I, and EPA-82-J. The new monitoring wells were installed in the locations shown on Figure 1.2. The well locations were selected to provide the hydrogeologic data necessary for successful implementation of the Bioplume II model and to support intrinsic remediation. Table 2.1 presents well completion details.

2.1.2 Well Drilling and Installation Procedures

This section describes the procedures used for drilling and installation of new monitoring wells. All new monitoring wells were installed in accordance with general procedures outlined in Section 8.5 of *A Compendium of Superfund Field Methods* (USEPA, 1987).

2.1.2.1 Pre-Drilling Activities

All necessary digging, drilling, and ground water monitoring well installation permits were obtained prior to mobilizing to the field. In addition, all utility lines were located and proposed drilling locations were cleared prior to any drilling activities.

Water used in drilling, equipment cleaning, or grouting were obtained from an onsite potable water supply. Water use approval was verified by contacting the appropriate facility personnel.

2.1.2.2 Equipment Decontamination Procedures

Prior to arriving at the site, and between each drilling location, the drill rig, augers, drilling rods, bits, casing, samplers, tools, and other downhole equipment were decontaminated using a high-pressure, steam/hot water wash. Only potable water was used for decontamination.

During drilling operations, the drill rig, augers, and any downhole drilling and/or sampling equipment were decontaminated at the north end of the industrial waste treatment plant (IWTP) at Hill AFB. Water from the decontamination operations was allowed to collect in the decontamination pad collection

TABLE 2.1

**WELL COMPLETION INFORMATION
UST SITE 870 INTRINSIC REMEDIATION EE/CA
HILL AFB, UTAH**

WELL NUMBER	EASTING**	NORTHING***	DATUM* ELEVATION (ft msl)	GROUND ELEVATION (ft msl)	TOTAL DEPTH (ft btoc)	INNER WELL DIAMETER (inches)	SCREEN LENGTH (feet)	DEPTH TO SCREEN TOP (ft btoc)	BASE (ft btoc)	SCREEN TOP (feet)
PREVIOUSLY EXISTING MONITORING WELLS										
MW-1	2475.32	3841.98	4683.91	4684.24	28.20	4.00	10.00	18.00	28.00	4665.91
MW-2	2389.21	3846.24	4684.39	4681.89	27.90	4.00	10.00	15.00	25.00	4669.39
MW-3	2533.09	3882.19	4690.67	4688.43	37.24	6.00	20.00	15.00	35.00	4675.67
MW-4	2446.70	3798.05	4682.13	4682.56	24.68	6.00	10.00	14.00	24.00	4668.13
MW-5	2536.47	3813.49	4686.76	4687.17	27.39	4.00	10.00	17.50	27.50	4669.26
MW-6	2389.06	3794.35	4679.03	4679.34	29.34	4.00	10.00	20.00	30.00	4659.03
MW-7	2621.27	3900.79	4693.80	4691.85	40.20	4.00	10.00	28.00	38.00	4665.80
MW-8	2449.70	3893.96	4688.02	4686.66	29.72	2.00	10.00	20.00	30.00	4668.02
MW-9	2529.21	3930.05	4692.09	4689.68	36.65	2.00	20.00	15.00	35.00	4677.09
MW-10	2354.84	3397.60	4662.67	4662.95	44.94	6.00	20.50	25.00	45.50	4637.67
MW-11	1923.08	3213.91	4637.37	4637.58	45.32	6.00	20.50	25.00	45.50	4612.37
MW-12	2457.72	3650.34	4676.87	4677.35	44.80	6.00	20.50	24.50	45.00	4652.37
NEWLY INSTALLED MONITORING WELLS										
EPA-82-A	1546.62	2945.10	4606.35	4606.01	30.40	2.00	5.00	25.00	30.00	4581.35
EPA-82-B	2062.23	3063.44	4633.28	4632.99	30.45	2.00	10.00	20.05	30.05	4613.23
EPA-82-C	1840.49	3035.78	4625.17	4624.92	24.75	2.00	5.00	19.35	24.35	4605.82
EPA-82-D	2167.57	3507.69	4655.39	4655.13	29.81	2.00	10.00	19.41	29.41	4635.98
EPA-82-E	1345.36	2845.36	4600.13	4599.74	9.32	2.00	5.00	3.92	8.92	4596.21
EPA-82-F	1543.19	2943.57	4606.19	4605.89	9.30	2.00	5.00	3.90	8.90	4602.29
EPA-82-H	1964.51	2719.71	4610.81	4610.57	24.50	2.00	15.00	9.10	24.10	4601.71
EPA-82-I	2520.42	3771.26	4683.08	4682.80	23.25	2.00	5.00	17.85	22.85	4665.23
EPA-82-J	2398.75	3645.85	4675.82	4676.17	32.30	2.00	10.00	22.30	32.30	4653.52
MW-13	2573.50	3896.74	4689.21	4689.56	35.00	7.25	10.00	10.00	35.00	4679.21
MW-14	2548.14	3861.96	4686.21	4686.53	35.00	7.25	10.00	10.00	35.00	4676.21
PIEZOMETERS										
CPT-2	NA	NA	NA	NA	27.00	0.50	5.00	22.00	27.00	NA
CPT-3	NA	NA	NA	NA	26.00	0.50	5.00	21.00	26.00	NA
CPT-4	NA	NA	NA	NA	27.60	0.50	5.00	22.60	27.60	NA
CPT-6	NA	NA	NA	NA	24.00	0.50	5.00	19.00	24.00	NA
CPT-7	2547.88	3772.45	4684.21	4684.37	23.85	0.50	5.00	18.85	23.85	4665.36

TABLE 2.1 (Continued)

**WELL COMPLETION INFORMATION
UST SITE 870 INTRINSIC REMEDIATION EE/CA
HILL AFB, UTAH**

WELL NUMBER	EASTING**	NORTHING***	DATUM*	GROUND	TOTAL	INNER WELL	SCREEN	DEPTH TO SCREEN		SCREEN E
			ELEVATION (ft msl)	ELEVATION (ft msl)	DEPTH (ft btoc)	DIAMETER (inches)	LENGTH (feet)	TOP (ft btoc)	BASE (ft btoc)	TOP (feet)
PIEZOMETERS (Continued)										
CPT-10	2602.28	3772.04	4686.54	4686.80	25.50	0.50	5.00	20.50	25.50	4666.04
CPT-11	NA	NA	NA	NA	30.25	0.50	5.00	25.25	30.25	NA
CPT-12	2354.84	3397.60	4662.67	4662.95	NA	0.50	5.00	NA	NA	NA
CPT-13	2062.91	3060.14	4633.21	4633.43	24.00	0.50	5.00	19.00	24.00	4614.21
CPT-14	2182.60	3507.60	4655.88	4656.10	28.28	0.50	5.00	23.28	28.28	4632.60
CPT-15	2262.51	2985.53	4638.74	4638.92	35.40	0.50	5.00	30.40	35.40	4608.34
CPT-17	1528.38	3493.12	4635.28	4635.51	14.41	0.50	5.00	9.41	14.41	4625.87
CPT-18	1885.05	3457.77	4641.46	4641.82	15.09	0.50	5.00	10.09	15.09	4631.37
CPT-19	1948.46		4636.98	4637.31	33.35	0.50	5.00	28.35	33.35	4608.63
CPT-20	1848.28	3037.59	4625.48	4625.69	28.20	0.50	5.00	23.20	28.20	4602.28
CPT-21	2349.56	3244.25	4655.91	4656.26	34.15	0.50	5.00	29.15	34.15	4626.76
CPT-22	NA	NA	NA	NA	25.35	0.50	5.00	20.35	25.35	NA
CPT-23	2526.12	2835.21	4642.49	4642.69	31.00	0.50	5.00	26.00	31.00	4616.49
CPT-25	NA	NA	NA	NA	38.00	0.50	5.00	33.00	38.00	NA
CPT-26	1208.02	2573.01	4591.94	4592.20	12.30	0.50	5.00	7.30	12.30	4584.64
CPT-27	1662.55	2660.73	4604.04	4604.32	10.00	0.50	5.00	5.00	10.00	4599.04
CPT-28	1538.79	2939.72	4605.62	4605.96	7.77	0.50	5.00	2.77	7.77	4602.85
CPT-29	1400.23	2863.23	4600.67	4600.89	7.00	0.50	5.00	2.00	7.00	4598.67
CPT-30	1963.38	2711.28	4610.22	4610.48	15.35	0.50	5.00	10.35	15.35	4599.87
CPT-31	1418.19	3205.92	4610.88	4611.15	10.35	0.50	5.00	5.35	10.35	4605.53
CPT-33	NA	NA	NA	NA	NA	0.50	5.00	NA	NA	NA
CPT-34	NA	NA	NA	NA	21.90	0.50	5.00	16.90	21.90	NA
CPT-36	2670.91	3231.11	4669.78	4670.01	35.00	0.50	5.00	30.00	35.00	4639.78
CPT-37	1970.30	2978.15	4625.35	4625.60	27.50	0.50	5.00	22.50	27.50	4602.85
CPT-38	1177.69	3504.76	4615.66	4615.90	14.55	0.50	5.00	9.55	14.55	4606.11
CPT-40	2758.65	4145.21	4715.46	4715.05	55.33	0.50	20.00	35.33	55.33	4680.13
CPT-41	2857.64	3142.16	4675.19	4675.41	40.05	0.50	5.00	35.05	40.05	4640.14
CPT-42	3067.32	3238.57	4678.34	4678.49	39.73	0.50	5.00	34.73	39.73	4643.61
CPT-43	2683.44	3014.06	4659.74	4660.02	37.60	0.50	5.00	32.60	37.60	4627.14
CPT-44	NA	NA	NA	NA	41.00	0.50	5.00	36.00	41.00	NA

TABLE 2.1 (Concluded)

**WELL COMPLETION INFORMATION
UST SITE 870 INTRINSIC REMEDIATION EE/CA
HILL AFB, UTAH**

WELL NUMBER	EASTING**	NORTHING***	DATUM*	GROUND ELEVATION	TOTAL DEPTH	INNER WELL DIAMETER	SCREEN LENGTH	DEPTH TO SCREEN		SCREEN ELEVATION	
			ELEVATION (ft msl)	(ft msl)	(ft btoc)	(inches)	(feet)	TOP (ft btoc)	BASE (ft btoc)	TOP (feet)	BASE (feet)
GEOPROBE											
EPA-82-K	1458.62	2656.22		4598.38	9.64	0.25	****	9.64	9.64	4588.74	4588.74
EPA-82-L1	-8055.75	2834.32		4614.15	18.80	0.25	1.50	17.30	18.80	4596.85	4595.35
EPA-82-L2	-8055.75	2834.32		4614.15	21.80	0.25	1.50	20.30	21.80	4593.85	4592.35
EPA-82-L3	-8055.75	2834.32		4614.15	24.80	0.25	1.50	23.30	24.80	4590.85	4589.35
EPA-82-M	1700.5	2698.09		4605.01	12.00	0.25	****	12.00	12.00	4593.01	4593.01
EPA-82-M duplicate	1700.5	2698.09		4605.01	12.00	0.25	****	12.00	12.00	4593.01	4593.01
EPA-82-N	NA	2738.09		4599.81	8.00	0.25	****	8.00	8.00	4591.81	4591.81
EPA-82-O	1594.5	2688.82		4602.30	9.80	0.25	****	9.80	9.80	4592.50	4592.50
EPA-82-P	1776.37	2865.35		4612.65	19.00	0.25	****	19.00	19.00	4593.65	4593.65

* Datum is top of PVC well casing

** For absolute easting coordinates add 1,860,000 to these numbers

*** For absolute northing coordinates add 280,000 to these numbers

**** Sample collected from end of polyethylene tubing

ft btoc = Feet below top of PVC well casing

ft msl = Feet above mean sea level

NA = Data not available

tanks. Precautions were taken to minimize any impact to the area surrounding the decontamination pad that might result from the decontamination operations.

All sampling tools were cleaned onsite prior to use and between each sampling event with a clean water/phosphate-free detergent mix and a clean water rinse. All well completion materials were factory sealed. All decontamination activities were conducted in a manner so that the excess water was controlled and not allowed to flow into any open borehole.

Fuel, lubricants, and other similar substances were handled in a manner consistent with accepted safety procedures and standard operating practices. Well completion materials were stored near or in areas which could be affected by these substances.

2.1.2.3 Drilling and Soil Sampling

Drilling was accomplished by using the HSA method, modified with a hinged door on the lead auger. The use of the hinged door facilitated collection of representative soil samples over the entire range of contamination. The borings were drilled and continuously sampled to the proposed total depth of the monitoring well. A final borehole diameter of at least 8 inches (with the exception of EPA-82-J, which used a 6-inch boring) was used for the installation of wells with a 2-inch inside-diameter (ID) casing.

Continuous soil samples were obtained using a 3-inch-ID solid-barrel continuous sampling device. Samples were collected continuously over the full depth of the soil borehole. The soil samples collected were removed from the continuous sampler in 0.3-foot intervals and placed in clean glass jars for laboratory analysis. In addition, a portion of the soil sample was placed in a clean glass jar for photoionization detector (PID) headspace measurements for volatile organic compounds (VOCs) and lithologic logging. Representative portions of the soil samples collected for the headspace procedure were quickly transferred to clean glass jars, sealed with aluminum foil, and held for 15 minutes at an ambient temperature of 65 degrees Fahrenheit (°F) or greater. Semiquantitative measurements were made by puncturing the aluminum foil seal with the PID probe and reading the concentration of the headspace gases. The PID relates the concentration of total VOCs in the sample to an isobutylene calibration standard. The PID was also used to monitor the worker breathing zone.

The Parsons ES field hydrogeologist observed drilling and well installation activities, maintained a detailed descriptive log of subsurface materials recovered, and photographed representative samples. Final geologic boring logs are presented in Appendix A. These logs contain:

- Sample interval (top and bottom depth);
- Presence or absence of contamination based on odor, staining, and/or PID readings;
- Soil description, including color, major textural constituents, minor constituents, relative moisture content, plasticity of fines, cohesiveness, grain size, structure or stratification, relative permeability, and any other significant observations; and
- Lithologic contacts with the depth of lithologic contacts and/or significant textural changes recorded to the nearest 0.1 foot (1 inch).

Soils exhibiting petroleum hydrocarbon contamination based on PID screening were drummed and stored onsite during the drilling operations. Upon completion of the drilling activities, two composite samples from the contaminated soil drums were collected and analyzed by USEPA Methods SW8020 and SW8015 modified. Upon receipt of the soil analytical results, these soils were transferred for disposal to E.T. Technologies, Inc. in Salt Lake City, Utah by Hill AFB personnel. Clean soils were handled by Hill AFB personnel who were responsible for the final disposition of these soils.

2.1.2.4 Monitoring Well Installation

Ground water monitoring wells were installed in nine soil borings under this program. Detailed well installation procedures are described in the following paragraphs. Well completion diagrams are included in Appendix A.

2.1.2.4.1 Well Materials Decontamination

Well completion materials were inspected by the field hydrogeologist and determined to be clean and acceptable prior to use. All well completion materials were factory sealed. Pre-packaged sand, bentonite, and Portland[®] cement were used in well construction, and the bags were inspected for possible external contamination before use. Materials that could not be cleaned to the satisfaction of the field hydrogeologist were not used.

2.1.2.4.2 Well Casing

Upon completion of drilling, a monitoring well casing was installed. Well construction details were noted on a Monitoring Well Installation Record form. This information became part of the permanent field record for the site and is included in Appendix A.

Blank well casing was constructed of Schedule 40 polyvinyl chloride (PVC) with an ID of 2 inches. All well casing sections were flush-threaded, and glued joints were not used. The casing at each well was fitted with a threaded bottom plug and a top cap constructed of the same type of material as the well casing. The top cap was vented to maintain ambient atmospheric pressure within the well casing.

The field hydrogeologist verified and recorded the boring depth, the lengths of all casing sections, and the depth to the top of all well completion materials placed in the annulus between the casing and borehole wall. All lengths and depths were measured to the nearest 0.1 foot.

2.1.2.4.3 Well Screen

Well screens were constructed of flush-threaded, Schedule 40 PVC with an ID of 2 inches. The screens were factory slotted with 0.010-inch openings. Each well was screened so that seasonal fluctuations of the water table can be measured. Except where specified, the entire thickness of the sand interval of the shallow aquifer was screened. The position of the screen was selected by the field hydrogeologist after consideration was given to the geometry and hydraulic characteristics of the stratum in which the wells were screened.

2.1.2.4.4 Sand Filter Pack

A graded sand filter was placed around the screened interval from the bottom of the casing to approximately 2 feet above the top of the screen. Number 10-20 Colorado silica sand was used for the sand filter pack.

2.1.2.4.5 Annular Sealant

An annular seal of sodium bentonite pellets was placed above the sand pack. The pellet seal was a minimum of 2 feet thick and was hydrated in place with potable water. In wells EPA-82-A, EPA-82-B, EPA-82-C, EPA-82-D, EPA-82-E, EPA-82-F, EPA-82-H, and EPA-82-I, the pellet seal was overlaid with a Portland[®] cement/sodium bentonite grout that extends from the top of

the pellet seal to approximately 4.5 feet below ground surface (bgs). The Portland[®] cement/sodium bentonite grout mix consisted of one 94-pound sack of cement and about 5 pounds of bentonite for each 7 gallons of water used. The bentonite content of the grout did not exceed 8 percent by dry weight. In well EPA-82-J, Baroid[®] 3/8 bentonite chips were placed in the borehole from the top of the sand pack to approximately 4.8 feet bgs. The grout or bentonite chips were overlaid with concrete that extends to the ground surface.

2.1.2.4.6 Flush-Mount Protective Cover

Each monitoring well was completed with an at-grade protective cover. In areas with pavement, the at-grade covers were cemented in place using concrete blended to the existing pavement. All wells were completed with concrete pads that slope gently away from the protective casing to facilitate runoff during precipitation events.

2.1.2.5 Well Development

Before being sampled, newly installed monitoring wells were developed. Well development removes sediment from inside the well casing and flushes fines, cuttings, and drilling fluids from the sand pack and the portion of the formation adjacent to the well screen.

Well development was accomplished using a peristaltic pump. The pump tubing was regularly lowered to the bottom of the well so that fines were agitated and removed from the well in the development water. Development was continued until a minimum of 10 casing volumes of water were removed from the well and the pH, temperature, specific conductivity, dissolved oxygen (DO) concentration, and redox potential of the ground water had stabilized. All well development waters were collected in 55-gallon drums and transported to the Hill AFB IWTP plant for treatment and disposal.

2.1.2.6 Water Level Measurements

Water levels at all sampled monitoring wells were measured. Measurements were made using an electric water level probe capable of recording to the nearest 1/8 inch (0.01 foot). In addition, water level measurements were made in select piezometers and previously existing monitoring wells at the site.

2.1.2.7 Well Location and Datum Survey

The location and elevation of the new wells were surveyed by a registered surveyor soon after well completion. The horizontal location were measured relative to established Hill AFB coordinates. Horizontal coordinates were measured to the nearest 1 foot. Vertical location of the ground surface adjacent to the well casing and the measurement datum (top of the PVC well casing) were measured relative to a US Geological Survey (USGS) mean sea level datum. The ground surface elevation was measured to the nearest 0.1 foot, and the measurement datum elevation was measured to the nearest 0.01 foot.

2.2 GROUND WATER SAMPLING

This section describes the procedures used for collecting ground water quality samples. In order to maintain a high degree of quality control during this sampling event, the procedures described in the following sections were followed.

Ground water samples were collected in four phases under this program. Phase one occurred during the week of 2 August 1993, and consisted of collecting ground water samples near existing CPT locations using a Geoprobe®. This ground water sampling process is described in Section 2.2.3.1. The second phase of ground water sampling occurred during the week of 16 August 1993, and consisted of collecting ground water samples from monitoring wells and water samples from the stormwater drain. The procedures used to sample ground water monitoring wells are described in Section 2.2.3.2. The third phase of ground water sampling occurred during the week of 8 November 1993, and consisted of sampling ground water monitoring wells. The fourth phase of ground water sampling occurred during the week of 4 July 1994, and consisted of collecting ground water samples from monitoring wells and by using a Geoprobe®. In addition to the sampling events conducted under this program, several ground water sampling events have been conducted by MWI at this site.

Activities that occurred during ground water sampling are summarized below:

- Assembly and preparation of equipment and supplies;
- Inspection of the well integrity (for monitoring well sampling), including
 - Protective cover, cap and lock,
 - External surface seal and pad,
 - Datum reference, and

- Internal surface seal;
- Ground water sampling, including
 - Water level measurements,
 - Visual inspection of water,
 - Well casing or Geoprobe® point evacuation, and
 - Sampling;
- Sample preservation and shipment, including
 - Sample preparation,
 - Onsite measurement of physical parameters, and
 - Sample labeling and packing;
- Completion of sampling records;
- Completion of chain-of-custody records; and
- Sample disposition.

Detailed ground water sampling and sample handling procedures that were used are presented in following sections.

2.2.1 Ground Water Sampling Locations

Ground water samples were collected from existing and newly installed monitoring wells, from Geoprobe® ground water sampling equipment, and at accessible locations along the storm sewer.

2.2.1.1 Geoprobe® Sampling Locations

Ground water samples were collected using the Geoprobe® sampling apparatus near nine existing CPT locations (CPT-8, CPT-17, CPT-18, CPT-19, CPT-23, CPT-29, CPT-31, CPT-38, and CPT-39) during the week of 2 August 1994. During the week of 4 July 1994, ground water samples were collected using the Geoprobe® sampling apparatus at points EPA-82-K, EPA-82-L, EPA-82-M, EPA-82-N, EPA-82-O, and EPA-82-P. Geoprobe® sampling locations are shown in Figure 1.2.

2.2.1.2 Monitoring Well Sampling Locations

Nine new monitoring wells were installed in the locations shown on Figure 1.2. After completion of well installation and development activities, these wells were sampled using a peristaltic pump with dedicated polyethylene tubing. Previously existing monitoring wells were also sampled under this program.

2.2.1.3 Storm Sewer Sampling Locations

Water samples were collected from accessible locations along the storm sewer system shown on Figure 1.2. These samples are labeled storm-2 and storm-3.

2.2.2 Preparation for Sampling

All equipment used for sampling was assembled and properly cleaned and calibrated (if required) prior to arriving in the field. In addition, all record keeping materials were gathered prior to leaving the office.

2.2.2.1 Equipment Cleaning

All portions of sampling and test equipment that contacted the sample were thoroughly cleaned before use. This equipment included water level probe and cable, lifting line, test equipment for onsite use, and other equipment that contacted the samples. The following cleaning protocol was used:

- Cleaned with potable water and phosphate-free laboratory detergent;
- Rinsed with potable water;
- Rinsed with distilled or deionized water;
- Rinsed with reagent-grade acetone;
- Air dried prior to use.

2.2.2.2 Equipment Calibration

As required, field analytical equipment were calibrated according to the manufacturer's specifications prior to field use. This applied to equipment used for onsite chemical measurements of DO, redox potential, pH, specific conductivity, and temperature.

2.2.3 Sampling Procedures

Special care was taken to prevent contamination of the ground water and extracted samples through cross contamination from improperly cleaned equipment. Water level probes and cable used to determine static water levels and well total depths were thoroughly cleaned before and after field use and between uses at different sampling locations according to the procedures presented in Section 2.2.2.1. In addition, a clean pair of new, disposable nitrile gloves was worn each time a different well was sampled.

2.2.3.1 Geoprobe® Ground Water Sampling

The Geoprobe® system is a hydraulically powered percussion/probing machine used to advance sampling tools through unconsolidated soils. This system provides for the rapid collection of ground water (and soil and soil gas if necessary) samples at shallow depths while minimizing the generation of investigation-derived waste materials. Figure 2.1 is a diagram of the Geoprobe® system. The following sections describe the ground water sample collection methods and decontamination methods using the Geoprobe® system.

2.2.3.1.1 *Sampling Interval and Method*

Based on the anticipated ground water elevation, the sampling depth and interval were estimated prior to driving the Geoprobe® sampling rods into the ground. The Parsons ES field hydrogeologist verified the sampling depth by measuring the length of each Geoprobe® sampling rod prior to insertion into the ground. A disposable drive tip was placed at the tip of the Geoprobe® sampling rods. This tip was threaded on the uphole end to allow attachment of 3/8-inch, high-density polyethylene (HDPE) tubing. After reaching the desired depth, HDPE tubing was threaded through the center of the hollow Geoprobe® sampling rod and secured to the drive point. The tubing was perforated at the downhole end using a 1/16-inch drill bit at 1/4-inch intervals alternately offset at 90 degree angles. The Geoprobe® sampling rod was then pulled

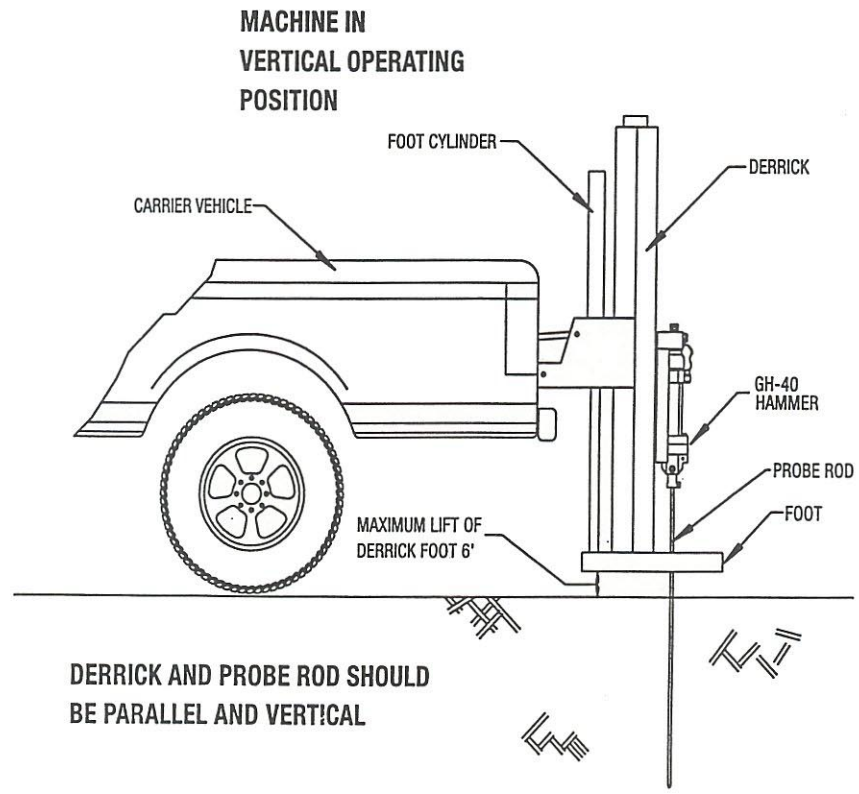

FIGURE 2.1

**CROSS-SECTION OF
GEOPROBE**

UST Site 870
Intrinsic Remediation EE/CA
Hill Air Force Base, Utah

**PARSONS
ENGINEERING SCIENCE, INC.**
Denver, Colorado

Source: Geoprobe Systems®, 1994.

back approximately 1 foot to allow ground water to enter the perforated end of the polyethylene tubing. When the rod was pulled up, the sampling tip remained at the probe termination depth, and the 1-foot perforated interval of the polyethylene tubing was exposed to ground water. Ground water samples were then acquired using a peristaltic pump, as described in Section 2.2.3.1.4.

2.2.3.1.2 Preparation of Location

Prior to sampling, the area around the well was cleared of foreign materials, such as brush, rocks, and debris. This prevented sampling equipment from inadvertently contacting foreign materials near the sampling point.

2.2.3.1.3 Water Level and Total Depth Measurements

Prior to removing any water from the Geoprobe® sampling location the static water level was measured. A manometer with hollow HDPE tubing was inserted into the HDPE tubing through which the ground water sample was acquired until positive pressure on the manometer indicated that ground water was reached. The manometer tube was then marked at the level of the ground surface and removed from the ground. Depth to water was determined by placing a tape measure next to the HDPE tubing and measuring the length from the base of the tubing to the ground level mark to the nearest 0.1 foot. Sampling depth was measured to the nearest 0.1 foot by noting the length of each section of Geoprobe® sampling rod placed in the ground.

2.2.3.1.4 Sample Extraction

A peristaltic pump was used to extract ground water samples from the Geoprobe® sampling point. Prior to sample collection, ground water was purged until DO and temperature readings stabilized. The samples were transferred directly to the appropriate sample container. The water was carefully poured down the inner walls of the sample bottle to minimize aeration of the sample.

2.2.3.1.5 Geoprobe® Equipment Decontamination

All geoprobe rids, tips, or other downhole equipment were decontaminated with a high pressure, steam/hot water wash. Enough linear feet of Geoprobe® rods and Geoprobe® tips were available that decontamination procedures were minimized to every fourth or fifth Geoprobe®

sampling location. Only potable water was used for decontamination. Collection of waters and decontamination of sampling tools is as described in Section 2.1.2.2.

2.2.3.2 Ground Water Monitoring Well Sampling

2.2.3.2.1 *Preparation of Location*

Prior to starting the sampling procedure, the area around the well was cleared of foreign materials, such as brush, rocks, and debris. These procedures prevented sampling equipment from inadvertently contacting debris around the monitoring well.

2.2.3.2.2 *Water Level and Total Depth Measurements*

Prior to removing any water from the well the static water level was measured. An electric water level probe was used to measure the depth to ground water below the datum to the nearest 0.01 foot. After measurement of the static water level, the water level probe was lowered to the bottom of the well for measurement of total well depth (recorded to the nearest 0.01 foot). Based on these measurements, the volume of water purged from the wells was calculated.

2.2.3.2.3 *Well Bore Purging*

Three times the calculated casing volume was removed from each well prior to sampling. All purge water was placed in 55-gallon drums and transported to the Hill AFB IWTP for disposal and treatment. The empty drums were rinsed with hot water and returned to base personnel for reuse. A peristaltic pump with dedicated Teflon[®]-lined polyethylene tubing was used for well evacuation.

2.2.3.2.4 *Sample Extraction*

A peristaltic pump with dedicated Teflon[®]-lined polyethylene tubing was used to extract ground water samples from the well. The sample was transferred directly to the appropriate sample container. The water was carefully poured down the inner walls of the sample bottle to minimize aeration of the sample.

2.2.3.3 Storm Sewer Sampling

A peristaltic pump with dedicated Teflon[®]-lined polyethylene tubing was used to extract ground water samples from the storm sewer. The sample was transferred directly to the appropriate sample container. The water was carefully poured down the inner walls of the sample bottle to minimize aeration of the sample.

2.2.4 Onsite Chemical Parameter Measurement

2.2.4.1 Dissolved Oxygen Measurements

DO measurements were taken using an Orion[®] model 840 DO meter. Groundwater was continuously extracted and collected in an erlenmeyer flask using a peristaltic pump. The probe of the DO meter was submerged in the erlenmeyer flask to monitor DO concentrations. DO concentrations were recorded after DO readings stabilized and these readings represent the lowest DO concentration observed.

2.2.4.2 Reduction/Oxidation Potential Measurements

Redox potential measurements were taken in a similar manner as DO measurements using an Orion[®] model 290A redox potential meter. Groundwater was continuously extracted with a peristaltic pump and collected in an erlenmeyer flask. The redox probe was submerged in the erlenmeyer flask to take continuous redox measurements. Redox potential measurements were recorded after the readings stabilized and these readings represent the lowest redox potential observed.

2.2.4.3 pH, Temperature, and Specific Conductance

Because the pH, temperature, and specific conductance of the ground water change significantly within a short time following sample acquisition, these parameters were measured in the field. The measurements were made in a clean glass container separate from those intended for laboratory analysis, and the measured values were recorded in the ground water sampling record.

2.2.5 Sample Handling

2.2.5.1 Sample Preservation

The USEPA Mobile Laboratory added any necessary chemical preservatives to sample containers prior to sampling. Soil samples collected for VOC analysis were stored in 40 milliliter (mL) volatile organic analysis (VOA) vials and preserved with 5 mL of acidified water (pH < 2) and 5 mL of methylene chloride. Soil samples (°C) in coolers. Ground water samples collected for VOC analysis were stored in 40 mL VOA vials with lead lined septa and preserved with 4 grams of trisodium phosphate. Ground water samples for all oxidized inorganic compounds, with the exception of nitrate, were stored in 200 mL high density polyethylene (HDPE) sample containers and stored at 4°C or below. Ground water samples collected for nitrate analysis were stored in 200 mL HDPE sample containers and acidified (pH<2) with sulfuric acid. All analysis for reduced inorganic speceies (e.g. ferrous iron, nitrate, and methane) were performed immediately in the field.

2.2.5.2 Sample Container and Labels

Sample containers and appropriate container lids were provided by the EPA Mobile Laboratory. The sample containers were filled as described in Sections 2.2.3.1.4, 2.2.3.2.4, and 2.2.3.3, and the container lids were tightly closed. Samples to be analyzed for VOCs were collected into containers with zero headspace. The sample label was firmly attached to the container side, and the following information was legibly and indelibly written on the label:

- Facility name;
- Sample identification;
- Sample type (ground water);
- Sampling date;
- Sampling time;
- Preservatives added; and,
- Sample collector's initials.

2.2.5.3 Sample Shipment

After the samples were sealed and labeled, they were packaged for immediate transport to the onsite USEPA Mobile Laboratory. The following packaging and labeling procedures were followed:

- Sample was packaged to prevent leakage or vaporization from its container;
- Shipping container was labeled with
 - Sample collector's name, address, and telephone number;
 - Laboratory's name, address, and telephone number;
 - Description of sample;
 - Quantity of sample; and
 - Date of transfer to onsite laboratory.

The packaged samples were delivered to the USEPA Mobile Laboratory. Delivery occurred shortly after sample acquisition.

2.3 AQUIFER TESTING

2.3.1 Slug Testing

Slug tests were conducted to estimate the hydraulic conductivity of the shallow saturated zone at UST Site 870. Slug tests are single-well hydraulic tests used to determine the hydraulic conductivity of an aquifer in the immediate vicinity of the tested well. Slug tests can be used for both confined and unconfined aquifers that have a transmissivity of less than 7,000 square feet per day (ft²/day). Slug testing can be performed using either a rising head or a falling head test. Rising head tests generally give more accurate results and were used at this site. Slug tests were performed in monitoring wells EPA 82-C, EPA 82-F, EPA 82-G, EPA 82-H, and EPA 82-I. Detailed slug testing procedures are presented in the *Draft Technical Protocol for Implementing the Intrinsic Remediation with Long-Term Monitoring Option for Natural Attenuation of Dissolved-Phase Fuel Contamination in Ground Water* (Wiedemeier *et al.*, 1994), hereafter referred to as the Technical Protocol document.

2.3.1 Slug Test Data Analysis

Data obtained during slug testing were analyzed using AQTESOLV software and the method of Bouwer and Rice (1976) and Bouwer (1989) for unconfined conditions. The results of slug testing are presented in Section 3.3.

2.4 SURVEYING

After completion of field work all new monitoring wells, soil boring locations, and those Geoprobe[®] sampling locations not located immediately adjacent to a CPT test location were surveyed by a State of Utah licensed professional land surveyor. Horizontal location was surveyed to the nearest 0.1 foot. Datum and ground surface elevations for were surveyed to the nearest 0.01 foot.

SECTION 3

PHYSICAL CHARACTERISTICS OF THE STUDY AREA

This section incorporates data collected during investigations as summarized by JMM (1993b) and MWI (1994a and 1994b), and more recent investigations conducted by Parsons ES in conjunction with researchers from the USEPA RSKERL in August 1993 and July 1994, to describe the physical characteristics of UST Site 870. The investigative techniques used by Parsons ES and RSKERL researchers to determine the physical characteristics of UST Site 870 are discussed in Section 2.

3.1 SURFACE FEATURES

3.1.1 Topography and Surface Water Hydrology

UST Site 870 is located on a plateau-like bench formed by the paleodelta of the ancient Weber River. This delta was formed as the Weber River deposited its sediment load when it entered ancient Lake Bonneville. Surface topography at the site slopes to the southwest (Figure 1.1). There are no naturally occurring surface water bodies in the immediate vicinity of UST Site 870. There are, however, several manmade features at or near the site that influence surface water runoff. These features are discussed in Section 3.1.2.

3.1.2 Manmade Features

Surface cover at UST Site 870 and adjacent areas consists of asphalt paving, grass, residential housing, concrete overlays, etc. Precipitation either infiltrates into the ground surface or is collected in gutters along the numerous roads in the Patriot Hills housing complex and diverted into several stormwater sewers in the Patriot Hills housing area. Figure 3.1 shows the locations of stormwater sewers in the area. One storm sewer, located along Cambridge Street, potentially intercepts ground water flow. There is a stormwater collection pond (Pond 3) located to the southwest of the Patriot Hills Housing Area (Figure 3.1).

3.2 REGIONAL GEOLOGY AND HYDROGEOLOGY

Three aquifers are present in the vicinity of UST Site 870. In order of increasing depth, these aquifers are the shallow aquifer, the Sunset Aquifer, and the Delta Aquifer. Hill AFB is located just west of the Wasatch Front in north-central Utah. Sediment comprising the shallow subsurface in the area consists of unconsolidated clay, silt, sand, and gravel which was eroded from the Wasatch Front and deposited as fluvial-deltaic basin-fill deposits where the ancient Weber River entered Lake Bonneville during Quaternary and Recent times (Feth *et al.*, 1966).

The shallow aquifer in the vicinity of UST Site 870 is the subject of this study and is discussed in detail in the following sections. Insufficient data are available for ground water in the Sunset Aquifer beneath UST Site 870 to allow an assessment of ground water quality. Total dissolved solids (TDS) values for the Delta Aquifer range from 156 to 354 milligrams per liter (mg/L) (JMM, 1993b). These TDS values, and the fact that no regulated contaminants have been detected in ground water of the Delta Aquifer, allow this aquifer to be classified as Class IA (Pristine Ground Water) under Utah Administrative Code (UAC) R448-6-3.

3.3 SITE GEOLOGY AND HYDROGEOLOGY

Characterization of the vadose zone and shallow aquifer system at UST Site 870 has been the objective of several site investigations. MWI (formerly JMM) installed 44 CPT test holes (some of which contain piezometers) and 14 ground water monitoring wells (MW prefix) at UST Site 870. Figure 1.2 shows the locations of these test holes and wells. During the week of 2 August 1993, Parsons ES, in conjunction with researchers from the USEPA RSKERL, collected 17 Geoprobe[®] ground water samples at 9 locations (shallow and deep testing) next to the CPT locations previously investigated by MWI. During the week of 16 August 1993, Parsons ES, in conjunction with researchers from the RSKERL, drilled eight soil borings in which ground water monitoring wells were installed. These soil boreholes/monitoring wells are designated EPA-82-A, EPA-82-B, EPA-82-C, EPA-82-D, EPA-82-E, EPA-82-F, EPA-82-H, and EPA-82-I (Sample location designation EPA 82-G was used for ground water samples collected from the stormwater drain running parallel to Cambridge Street). During the week of 4 July 1994, Parsons ES, in conjunction with researchers from the RSKERL, drilled two soil borings designated EPA-82-J and EPA-82-KK. A monitoring well, designated EPA-82-J was installed in soil boring EPA-82-J. No monitoring well was installed in soil boring EPA-82-KK. Table 2.1 presents available well and piezometer completion information.

3.3.1 Lithology and Stratigraphic Relationships

The shallow sediments underlying UST Site 870 and the Patriot Hills housing area are comprised of shallow, light reddish-brown to dark gray, cohesive clayey silts to silty clays. This clayey silt to silty clay interval ranges in thickness from approximately 4 feet to 15 feet and is abruptly underlain by poorly to moderately sorted, yellowish-brown to reddish-brown, silty fine-grained sands that coarsen downward into moderately sorted medium- to coarse-grained sands. These sands range in thickness from approximately 3 to 22 feet and the shallow saturated zone at the site occurs within these sands. Underlying the sands is a sequence of competent, thinly interbedded clay to silty clay and fine- to very-fine-grained clayey sand and silt of unknown thickness. This sequence of interbedded clay and fine-grained sand and silt appears to act as an effective barrier to the vertical migration of water and contaminants.

These stratigraphic relationships are illustrated by hydrogeologic sections A-A' and B-B'. Figure 3.2 shows the locations of these sections. Figure 3.3 presents hydrogeologic section A-A', which is oriented approximately parallel to the direction of ground water flow. Figure 3.4 presents hydrogeologic section B-B', which is oriented approximately perpendicular to the direction of ground water flow.

3.3.2 Grain Size Distribution

Grain size analyses were performed by JMM on soil samples from the soil borings completed as monitoring wells MW-5 (sample collected from approximately 31 feet bgs) and MW-6 (sample collected from approximately 31 feet bgs). Both samples are representative of the deep interbedded clay to silty clay and fine- to very-fine-grained clayey sand and silt described earlier. Seventy to 90 percent of the soils from both samples passed through the #200 US Standard Sieve. The #200 sieve size represents the break between fine sand and silt, and therefore these sediments are dominated by silt and clay.

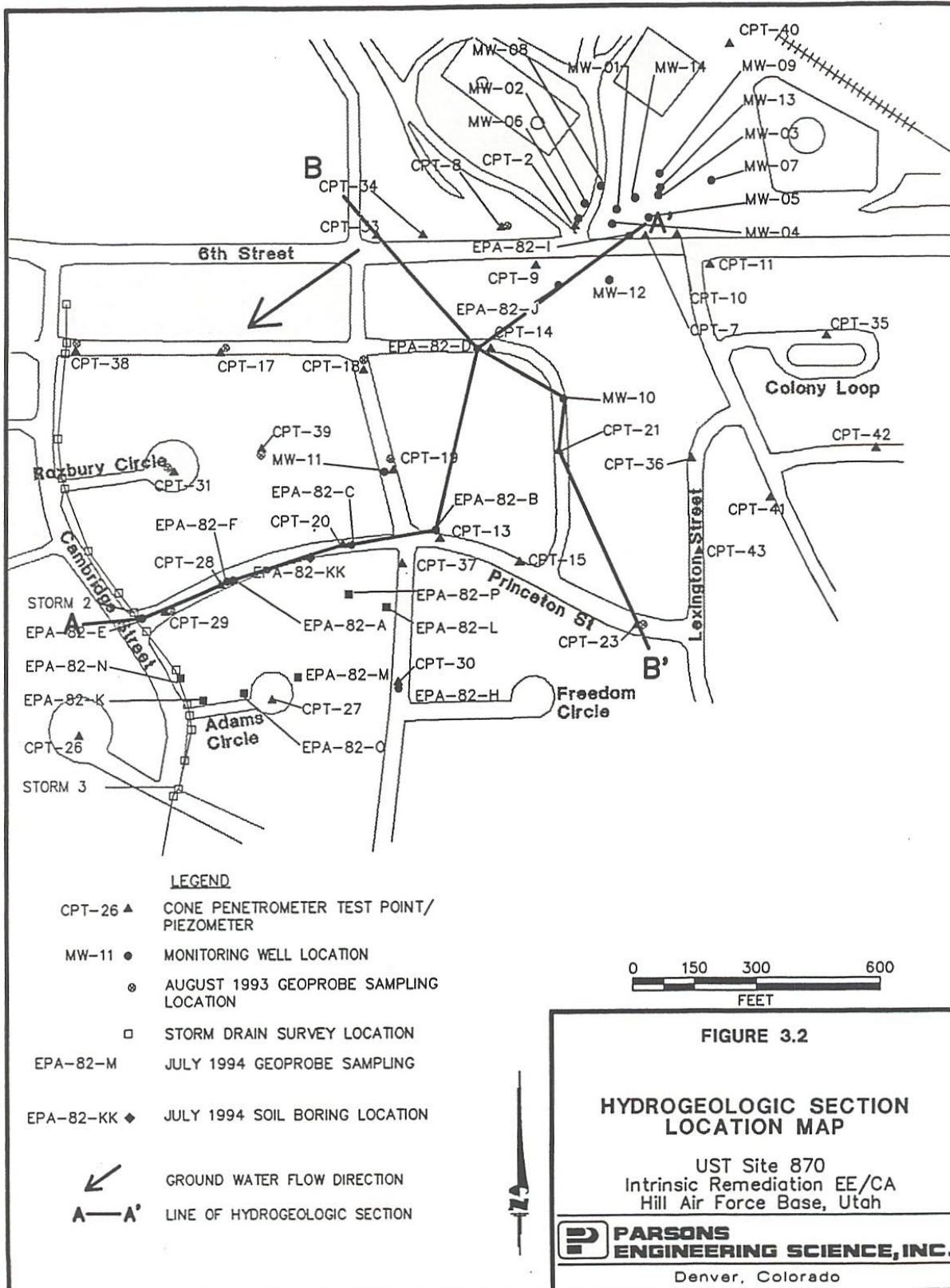

M:\45002\DRAWNGS\92DN0903, 09/21/94 at 08:30 3-5 LAYER: SECTION

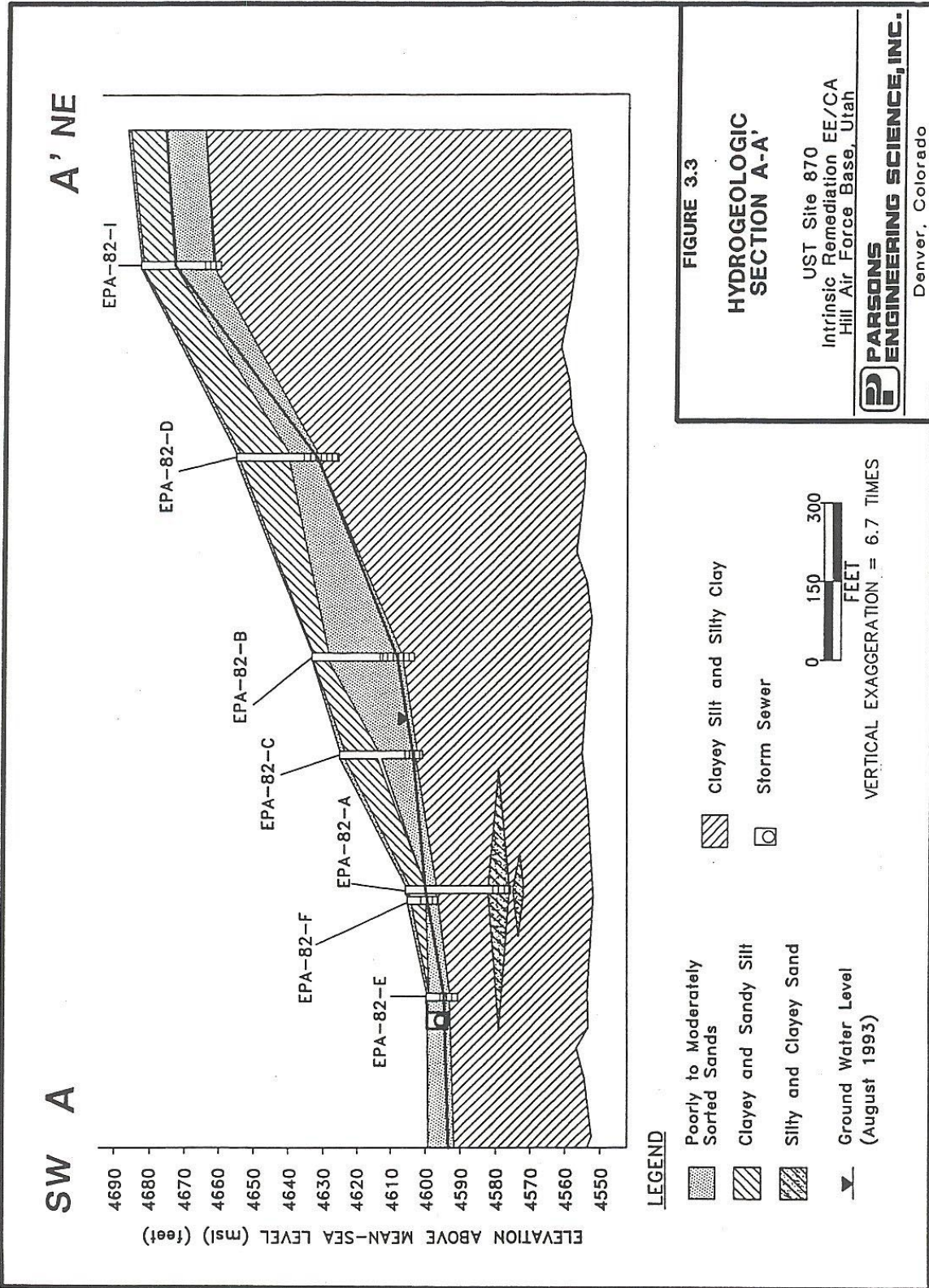

L:\45002\DRAWINGS\BORDER, 06/20/95 at 11:20

3-6

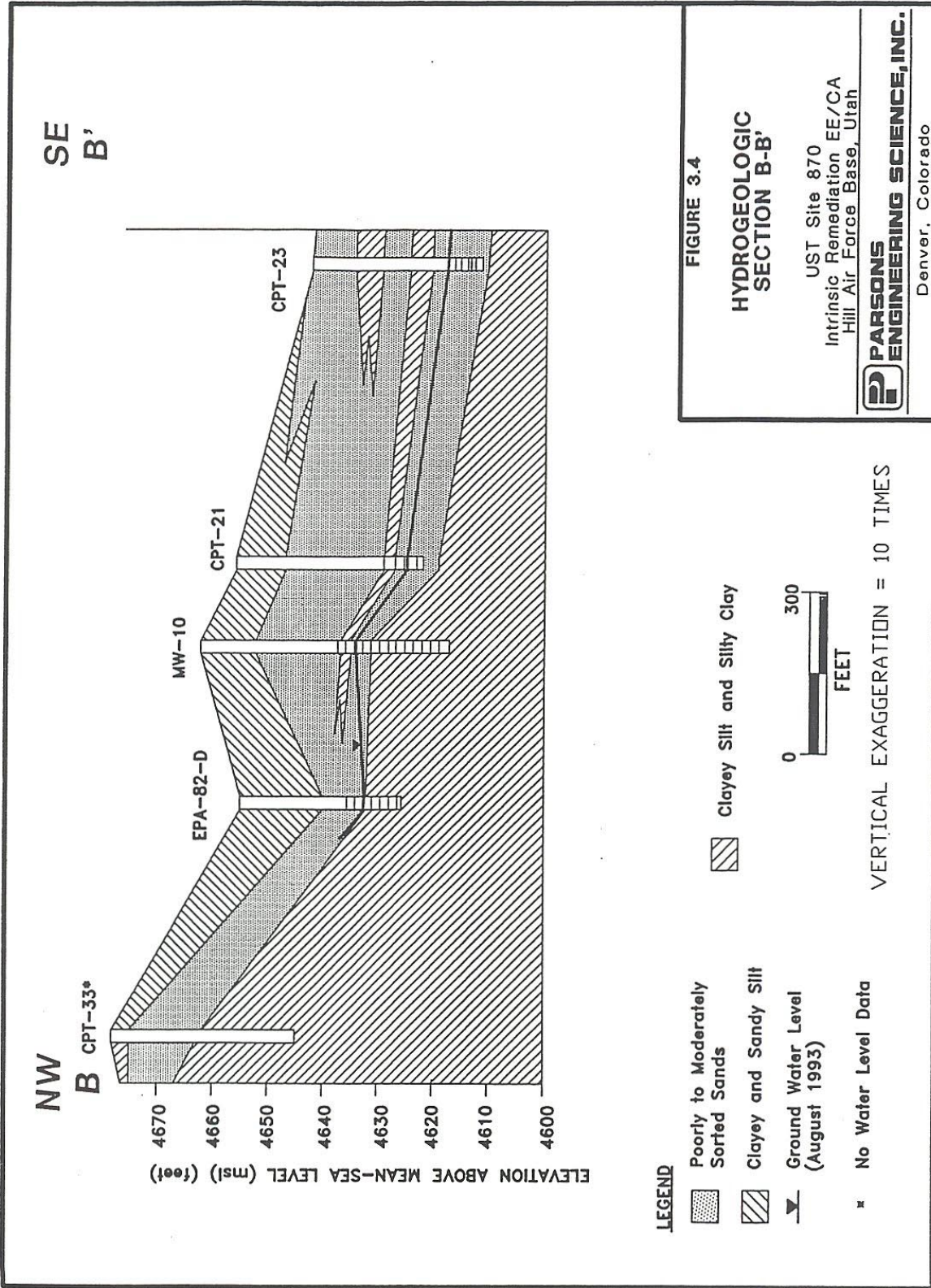

3.3.3 Ground Water Hydraulics

3.3.3.1 Flow Direction and Gradient

Ground water flow in the vicinity of UST Site 870 is to the southwest, with an average gradient of approximately 0.048 foot per foot (ft/ft) between wells EPA-82-I and CPT-27 (Figure 3.5). Available ground water elevation data are presented in Appendix B. Ground water flow appears to be limited to a relatively thin zone in the medium- to coarse-grained sands located immediately above the lower thinly interbedded clay to silty clay and fine- to very-fine-grained clayey sand and silt horizon (Figures 3.3 and 3.4). Available site data show that there is almost no seasonal variation in ground water flow direction or gradient at the site (Appendix B and MWI, 1994b).

3.3.3.2 Hydraulic Conductivity (K)

Hydraulic conductivity in the medium- to coarse-grained sands of the shallow saturated zone was estimated using rising head slug tests as described in Section 2. Slug tests were performed in monitoring wells EPA-82-A, EPA-82-E, EPA-82-F, EPA-82-H, and EPA-82-I. The results of these slug tests are summarized in Table 3.1. The average hydraulic conductivity for the shallow saturated zone as determined from these tests is 0.0159 foot per minute or 0.0085 centimeter per second (cm/sec). Appendix A contains slug test results. In addition, JMM (1991) performed two slug tests in monitoring well MW-01. The hydraulic conductivity as determined from these tests ranged from 0.00015 to 0.00018 cm/sec.

The average hydraulic conductivity estimated by Parsons ES for the shallow saturated zone is one to two orders of magnitude higher than hydraulic conductivities estimated by JMM (1993b). As illustrated in available borelogs for both Parsons ES and JMM, the heterogeneous site stratigraphy is composed of numerous soil types including moderately sorted, silty fine-to medium-grained sand, medium- to coarse-grained sands, cohesive clayey silts to silty sands with a large interval (~4 ft) of clayey sand over the screened interval of the well. The locations selected by Parsons ES for slug testing (EPA installed wells) were characterized by predominately fine- to medium-grained sands over the well screen intervals; thus, higher values of hydraulic conductivity were derived because slug tests were conducted in more transmissive soils.

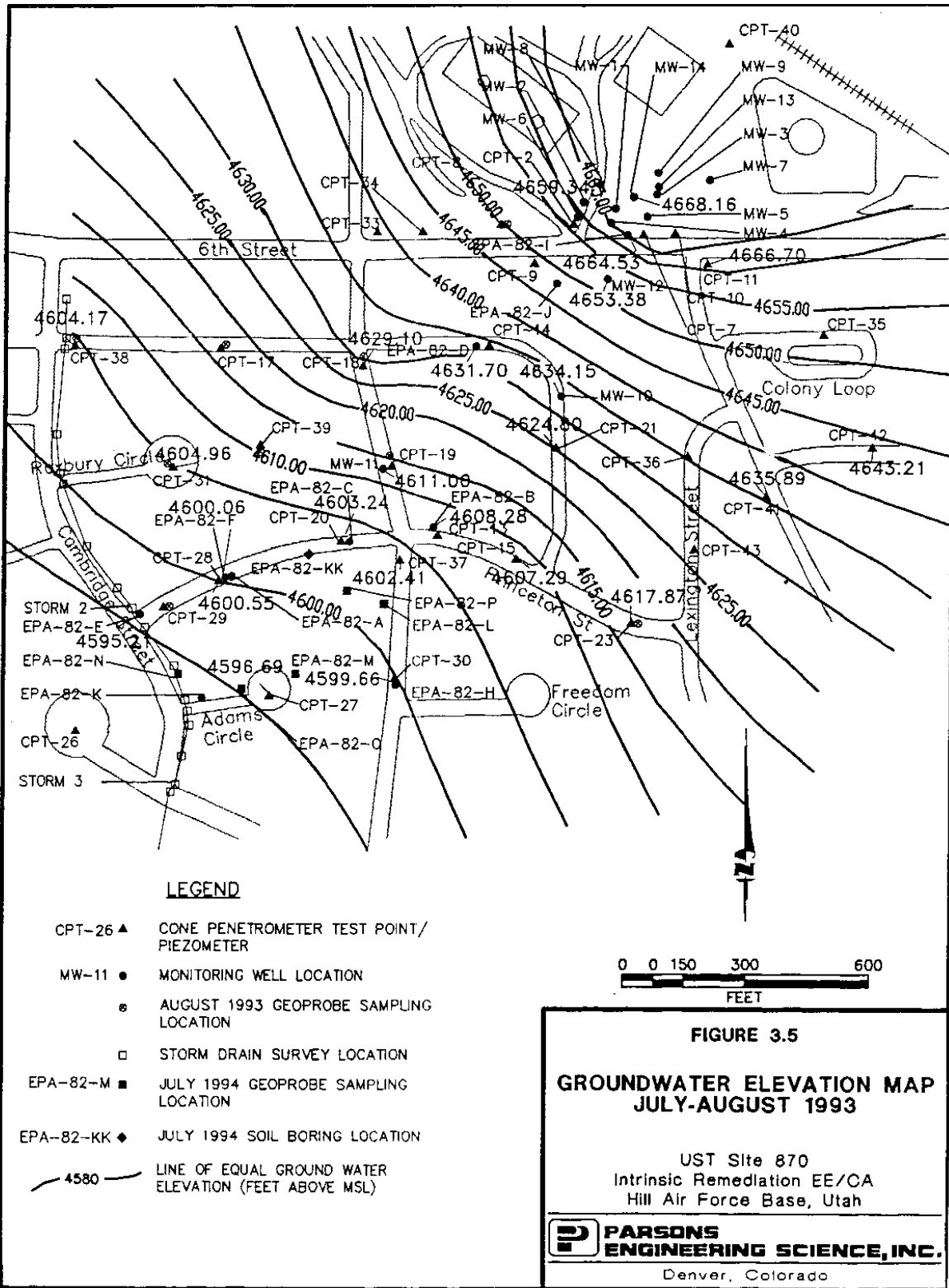

L:\45002\DRAWINGS\95DN0433, 3/17/95 at 9:15 3-9

Table 3.1
SLUG TEST RESULTS
UST SITE 870 INTRINSIC REMEDIATION EE/CA
HILL AFB, UTAH

WELL	TEST	HYDRAULIC CONDUCTIVITY (feet/minute)	HYDRAULIC CONDUCTIVITY (cm/sec)
EPA 82-A	Rising Head #1	1.19E-05	3.63E-04
EPA-82-E	Rising Head #1	5.50E-04	1.67E-02
EPA-82-E	Rising Head #2	6.08E-04	1.85E-02
EPA-82-F	Rising Head #1	1.36E-04	4.13E-03
EPA-82-F	Rising Head #2	1.08E-04	3.28E-03
EPA-82-H	Rising Head #2	2.48E-04	7.56E-03
EPA-82-H	Rising Head #3	2.73E-04	8.31E-03
EPA-82-I	Rising Head #1	1.57E-04	4.77E-03
EPA-82-I	Rising Head #2	3.58E-05	1.09E-03
	AVERAGE*	2.65E-04	8.05E-03

* Average of wells EPA-82-E, EPA-82-F, EPA-82-H, and EPA-82-I.

Well EPA-82-A completed in a sandy unit found within the deep silty clay

3.3.3.3 Effective Porosity (n_e)

Because of the difficulty involved in accurately determining effective porosity, accepted literature values for the type of soil comprising the shallow saturated zone were used. Freeze and Cherry (1979) give a range of effective porosity for sand of 0.25 to 0.50. To be conservative (lower effective porosity results in greater ground water velocity), the effective porosity for sediments of the shallow saturated zone is assumed to be 0.25.

3.3.3.4 Advective Ground Water Velocity (\bar{v})

The advective velocity of ground water in the direction parallel to ground water flow is given by:

$$\bar{v} = \frac{-K}{n_e} \frac{dH}{dL}$$

Where: \bar{v} = Average advective ground water velocity (seepage velocity) [L/T]

K = Hydraulic conductivity [L/T] (2.65×10^{-4} ft/sec)

dH/dL = Gradient [L/L] (0.048 ft/ft)

n_e = Effective porosity (0.25).

Using this relationship in conjunction with site-specific data, the average advective ground water velocity at the site is 4.4 feet per day (ft/day) or approximately 1,600 feet/year.

3.3.3.5 Preferential Flow Paths

Two preferential contaminant migration pathways were identified during the field work phase of this project. The first is a utility corridor on the north side of Sixth Street. This utility corridor runs parallel to Sixth Street. The influence of this corridor on contaminant migration has not been directly investigated but its influence on ground water flow is unlikely because of its relatively shallow depth.

The second potential preferential contaminant migration pathway is a storm sewer that intersects ground water flow in at least a portion of the site near Cambridge Street. This storm sewer is located along Cambridge Street (Figure 3.1). During field work conducted by Parsons ES and RSKERL personnel in August 1993, ground water appeared to be flowing in this storm sewer near the intersection of Cambridge and Princeton streets. The possibility that this water was ground water was supported by ground water elevation data and surveyor's data collected at several points along the storm sewer (e.g., culvert invert elevation data, see Figure 3.3). To determine if contaminated ground water was being intercepted by this storm sewer, two water samples, storm-2 and storm-3, were collected at the locations shown in Figure 1.2. The analytical results for these samples indicated that no ground water contamination was being intercepted by the storm drain in August 1993.

3.3.5 Ground Water Use

Ground water from the surficial aquifer at Hill AFB is not extracted for potable uses. Water is obtained from on-base deep supply wells in the months of October through April. Water is supplied by a combination of deep supply wells and water piped in from the nearby Weber Basin Water Conservancy District during the remainder of the year.

3.4 CLIMATOLOGICAL CHARACTERISTICS

Regional climatological characteristics for the site were obtained from an AWS Climatic Brief. Meteorology at the site is impacted by the Wasatch Range located west of the site. This range is oriented north-south and rises over 5,000 vertical feet above the valley floor in less than 5 miles, causing an abrupt barrier for Pacific frontal systems moving into northern Utah. This barrier, coupled with moisture from the Great Salt Lake, causes fronts to build up over Hill AFB, resulting in low cloud ceilings and prolonged periods of precipitation.

Monthly mean high temperatures range from about 27 °F in January to about 76 °F in July. Recorded extreme high and low temperatures for the period from 1941 to 1984 were 104 °F and -13 °F, respectively. Mean annual precipitation for this same period is 20.1 inches.

SECTION 4

NATURE AND EXTENT OF CONTAMINATION AND SOIL AND GROUND WATER GEOCHEMISTRY

4.1 SOURCE OF CONTAMINATION

The source of contamination at UST Site 870 is not known with any degree of certainty, nor is it known how much fuel leaked into the subsurface. About 700 gallons of LNAPL have been recovered by product recovery systems since their installation in June 1992. Former UST 870.0 may have contributed to the contamination observed at the site, but it is unlikely that leakage from this UST was responsible for all of the contamination. This UST was used to store condensate and residual JP-4 generated by operations at a nearby filter stand. Following the removal of UST 870.0, a new tank equipped with leak-detection equipment was installed in the same excavation. Based on the large quantity of contamination, other potential sources of contamination include: leaky piping associated with the UST, surface spills and releases from operations since the 1940s, and a faulty 6-inch diameter pipe located behind the pump facility Building 870 (pending repairs).

4.2 SOIL CHEMISTRY

4.2.1 Mobile LNAPL Contamination

Mobile LNAPL is defined as the LNAPL that is free to flow in the aquifer and that will flow from the aquifer matrix into a well under the influence of gravity. Mobile LNAPL is present in several monitoring wells and piezometers at the site (Appendix B). Figure 4.1 is an isopach map showing the distribution and measured thickness of mobile LNAPL at the site in July and August 1993. This map was prepared using the greatest mobile LNAPL thickness measured at each location during this period. The LNAPL plume appears to be comprised of weathered JP-4 that emanates from the aboveground storage tank facility. Figure 4.1 suggests that the LNAPL plume extended approximately 750 feet downgradient from the source area in July/August 1993.

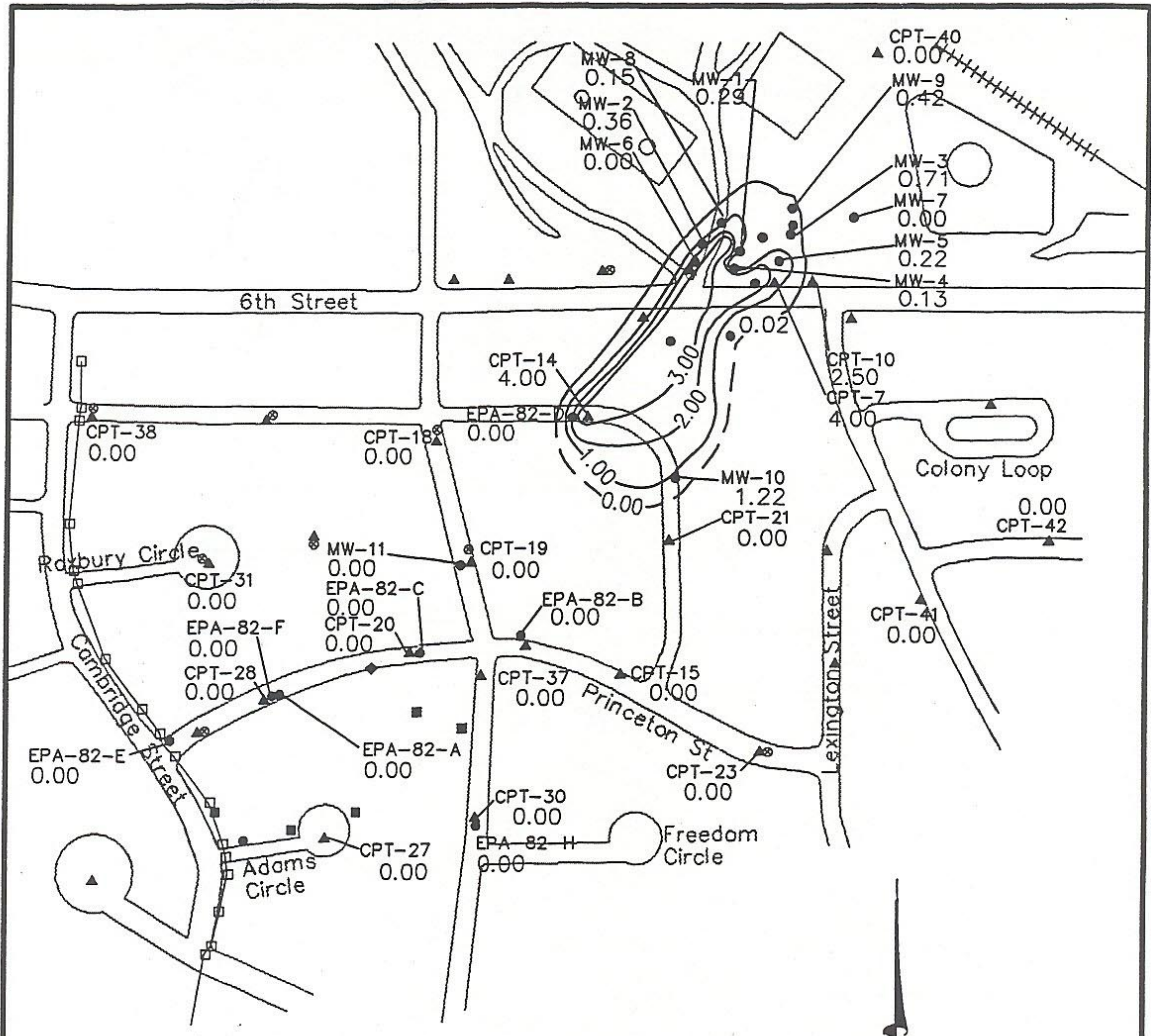

LEGEND

- CPT-26 ▲ CONE PENETROMETER TEST POINT/
PIEZOMETER
 - MW-11 ● MONITORING WELL LOCATION
 - AUGUST 1993 GEOPROBE SAMPLING
LOCATION
 - STORM DRAIN SURVEY LOCATION
 - EPA-82-M ■ JULY 1994 GEOPROBE SAMPLING
LOCATION
 - EPA-82-KK ◆ JULY 1994 SOIL BORING LOCATION
 - 1.00 — LINE OF EQUAL LNAPL
THICKNESS (FEET)
(GREATEST THICKNESS FOR JULY/
AUGUST 1993)
- CONTOUR INTERVAL = 1 FOOT

FIGURE 4.1
LNAPL ISOPACH MAP
JULY/AUGUST 1993

UST Site 870
Intrinsic Remediation EE/CA
Hill Air Force Base, Utah

PARSONS ENGINEERING SCIENCE, INC.
Denver, Colorado

The areal extent of suspected mobile LNAPL contamination is approximately 225,000 square feet. Concentrations of BTEX and trimethylbenzene (TMB) constituents in the mobile LNAPL were quantitated using a sample of LNAPL collected from MW-10 in August 1993. Concentrations of BTEX and TMBs in this sample indicate that the JP-4 comprising the LNAPL plume in this area is significantly weathered. Table 4.1 compares BTEX concentrations in fresh JP-4 to those observed in LNAPL from MW-10. Toluene and benzene concentrations are reduced by 1 to 3 orders of magnitude, respectively, and ethylbenzene and total xylene concentrations are reduced by about one-half.

TABLE 4.1
COMPARATIVE FRESH AND WEATHERED
LNAPL BTEX ANALYTICAL RESULTS
UST SITE 870 INTRINSIC REMEDIATION EE/CA
HILL AFB, UTAH

Contaminant	Concentration in Fresh JP-4 (mg/L)	Concentration in Weathered JP-4 from MW-10 (August, 1993) (mg/L)
Benzene	3750	1
Toluene	9975	134
Ethylbenzene	2775	1020
<i>o</i> -xylene	7575	2380
<i>m</i> -xylene	7200	5500
<i>p</i> -xylene	2625	1070

The relationship between measured LNAPL thickness and the amount of mobile LNAPL in the subsurface at a site is extremely difficult to quantify. Based on soil core data and measured LNAPL thicknesses, there appears to be a significant difference between measured LNAPL thickness and the actual thickness of mobile LNAPL present at the site. It is well documented that LNAPL thickness measurements taken in ground water monitoring wells are not indicative of actual mobile LNAPL thicknesses in the formation (Kemblowski and Chiang, 1990; Concawe, 1979; Abdul *et al.*, 1989; Testa and Paczkowski, 1989; Hughes *et al.*, 1988; Blake and Hall, 1984; Hall *et al.*, 1984; Hampton and Miller, 1988; Mercer and Cohen, 1990; de Pastrovich *et al.*,

1979; Lehnard and Parker, 1990; Ballestero, *et al.*, 1994). It has been noted by these authors that the thickness of LNAPL measured in a monitoring well is greater than the actual mobile LNAPL thickness present in the aquifer and, according to Mercer and Cohen (1990), measured LNAPL thickness in wells is typically 2 to 10 times greater than the actual mobile LNAPL thickness in the formation.

4.2.2 Residual-Phase (Stationary) LNAPL Contamination

Residual-phase LNAPL is defined as the LNAPL that is trapped in the aquifer by the processes of cohesion and capillarity and therefore will not flow within the aquifer and will not flow from the aquifer matrix into a well under the influence of gravity. The following sections describe the residual-phase LNAPL contamination found at UST Site 870.

4.2.2.1 Soil BTEX Contamination

Residual-phase BTEX contamination resulting from vertically and laterally migrating LNAPL is found over a wide area at UST Site 870. Table 4.2 contains soil BTEX and TPH data. Figure 4.2 is an isopleth map showing maximum observed total BTEX concentrations in soil at UST Site 870. Soil BTEX contamination appears to extend approximately 1,600 feet downgradient from the source area and is approximately 500 feet wide at the widest point. The highest observed concentration of residual-phase BTEX is 554 mg/kg in a soil core sample taken from approximately 18 feet bgs in soil boring EPA-82-I, which is in the suspected source area of JP-4 contamination. This corresponds with the highest measured TPH concentration of 28,300 mg/kg. Measured total BTEX concentrations decrease rapidly in areas devoid of mobile-phase LNAPL contamination, and the majority of the area shown in Figure 4.2 is characterized by total BTEX concentrations of less than 50 mg/kg.

4.2.2.2 Soil TPH Contamination

Figure 4.3 is an isopleth map showing TPH concentrations in soil. This figure shows that elevated TPH concentrations are widespread at the site. TPH levels exceed 28,000 mg/kg at EPA-82-I. TPH contamination appears to extend downgradient from the source area for approximately 1,600 feet with an approximate width of 450 feet. The vertical thickness of TPH contamination at concentrations above 100 mg/kg in the soil is approximately 7 feet at

TABLE 4.2
 FUEL HYDROCARBON COMPOUNDS DETECTED IN SOIL
 UST SITE 870 INTRINSIC REMEDIATION EE/CA
 HILL AFB, UTAH

Sample Location*	Sample Date	Sample Interval Top (ft bgs) Bottom (ft bgs)	Benzene (mg/kg)	Toluene (mg/kg)	Ethylbenzene (mg/kg)	P-Xylene (mg/kg)	M-Xylene (mg/kg)	M&P-Xylene (mg/kg)	O-Xylene (mg/kg)	Total Xylenes (mg/kg)	Total BTEX (mg/kg)	1,3,5-TMB (mg/kg)	1,2,4-TMB (mg/kg)	1,2,3-TMB (mg/kg)	TPH (mg/kg)
82 A-16	8/17/93	18.75 19.00	< 0.01	< 0.01	< 0.01	< 0.01	< 0.01	NA	< 0.01	<0.01	<0.01	< 0.01	< 0.01	< 0.01	NA
82 A-15	8/17/93	19.00 19.25	< 0.01	< 0.01	< 0.01	< 0.01	< 0.01	NA	< 0.01	<0.01	<0.01	< 0.01	< 0.01	< 0.01	NA
82 A-14	8/17/93	19.25 19.50	< 0.01	< 0.01	< 0.01	< 0.01	< 0.01	NA	< 0.01	<0.01	<0.01	< 0.01	< 0.01	< 0.01	NA
82 A-13	8/17/93	19.50 19.75	< 0.01	< 0.01	< 0.01	< 0.01	< 0.01	NA	< 0.01	<0.01	<0.01	< 0.01	< 0.01	< 0.01	NA
82 A-12	8/17/93	19.75 20.00	< 0.01	< 0.01	< 0.01	< 0.01	< 0.01	NA	< 0.01	<0.01	<0.01	< 0.01	< 0.01	< 0.01	NA
82 A-11	8/17/93	20.00 20.25	< 0.01	< 0.01	< 0.01	< 0.01	< 0.01	NA	< 0.01	<0.01	<0.01	< 0.01	< 0.01	< 0.01	NA
82 A-10	8/17/93	20.25 20.50	< 0.01	< 0.01	< 0.01	< 0.01	< 0.01	NA	< 0.01	<0.01	<0.01	< 0.01	< 0.01	< 0.01	NA
82 A-09	8/17/93	20.50 20.75	< 0.01	< 0.01	< 0.01	< 0.01	< 0.01	NA	< 0.01	<0.01	<0.01	< 0.01	< 0.01	< 0.01	NA
82 A-08	8/17/93	20.75 21.00	< 0.01	< 0.01	< 0.01	< 0.01	< 0.01	NA	< 0.01	<0.01	<0.01	< 0.01	< 0.01	< 0.01	NA
82 A-07	8/17/93	21.00 21.25	< 0.01	< 0.01	< 0.01	< 0.01	< 0.01	NA	< 0.01	<0.01	<0.01	< 0.01	< 0.01	< 0.01	NA
82 A-06	8/17/93	21.25 21.50	< 0.01	< 0.01	< 0.01	< 0.01	< 0.01	NA	< 0.01	<0.01	<0.01	< 0.01	< 0.01	< 0.01	NA
82 A-05	8/17/93	21.50 21.75	< 0.01	< 0.01	< 0.01	< 0.01	< 0.01	NA	< 0.01	<0.01	<0.01	< 0.01	< 0.01	< 0.01	NA
82 A-04	8/17/93	21.75 22.00	< 0.01	< 0.01	< 0.01	< 0.01	< 0.01	NA	< 0.01	<0.01	<0.01	< 0.01	< 0.01	< 0.01	NA
82 A-03	8/17/93	22.00 22.25	< 0.01	< 0.01	< 0.01	< 0.01	< 0.01	NA	< 0.01	<0.01	<0.01	< 0.01	< 0.01	< 0.01	NA
82 A-02	8/17/93	22.25 22.50	< 0.01	< 0.01	< 0.01	< 0.01	< 0.01	NA	< 0.01	<0.01	<0.01	< 0.01	< 0.01	< 0.01	NA
82 A-01	8/17/93	22.50 22.75	< 0.01	< 0.01	< 0.01	< 0.01	< 0.01	NA	< 0.01	<0.01	<0.01	< 0.01	< 0.01	< 0.01	NA
82 A-25	8/17/93	22.75 23.00	< 0.01	< 0.01	< 0.01	< 0.01	< 0.01	NA	< 0.01	<0.01	<0.01	< 0.01	< 0.01	< 0.01	NA
82 A-24	8/17/93	23.00 23.40	< 0.01	< 0.01	< 0.01	< 0.01	< 0.01	NA	< 0.01	<0.01	<0.01	< 0.01	< 0.01	< 0.01	NA
82 A-23	8/17/93	23.40 23.80	< 0.01	< 0.01	< 0.01	< 0.01	< 0.01	NA	< 0.01	<0.01	<0.01	< 0.01	< 0.01	< 0.01	NA
82 A-22	8/17/93	23.80 24.20	< 0.01	< 0.01	< 0.01	< 0.01	< 0.01	NA	< 0.01	<0.01	<0.01	< 0.01	< 0.01	< 0.01	NA
82 A-21	8/17/93	24.20 24.60	< 0.01	< 0.01	< 0.01	< 0.01	< 0.01	NA	< 0.01	<0.01	<0.01	< 0.01	< 0.01	< 0.01	NA
82 A-20	8/17/93	24.60 25.00	< 0.01	< 0.01	< 0.01	< 0.01	< 0.01	NA	< 0.01	<0.01	<0.01	< 0.01	< 0.01	< 0.01	NA
82 A-19	8/17/93	25.00 25.40	< 0.01	< 0.01	< 0.01	< 0.01	< 0.01	NA	< 0.01	<0.01	<0.01	< 0.01	< 0.01	< 0.01	NA
82 A-18	8/17/93	25.40 25.80	< 0.01	< 0.01	< 0.01	< 0.01	< 0.01	NA	< 0.01	<0.01	<0.01	< 0.01	< 0.01	< 0.01	NA
82 A-17	8/17/93	25.80 26.20	< 0.01	< 0.01	< 0.01	< 0.01	< 0.01	NA	< 0.01	<0.01	<0.01	< 0.01	< 0.01	< 0.01	NA
82 A-41	8/17/93	27.00 27.30	< 0.01	< 0.01	< 0.01	< 0.01	< 0.01	NA	< 0.01	<0.01	<0.01	< 0.01	< 0.01	< 0.01	NA
82 A-40	8/17/93	27.30 27.60	< 0.01	< 0.01	< 0.01	< 0.01	< 0.01	NA	< 0.01	<0.01	<0.01	< 0.01	< 0.01	< 0.01	NA
82 A-39	8/17/93	27.60 27.90	< 0.01	< 0.01	< 0.01	< 0.01	< 0.01	NA	< 0.01	<0.01	<0.01	< 0.01	< 0.01	< 0.01	NA
82 A-38	8/17/93	27.90 28.20	< 0.01	< 0.01	< 0.01	< 0.01	< 0.01	NA	< 0.01	<0.01	<0.01	< 0.01	< 0.01	< 0.01	NA
82 A-37	8/17/93	28.20 28.50	< 0.01	< 0.01	< 0.01	< 0.01	< 0.01	NA	< 0.01	<0.01	<0.01	< 0.01	< 0.01	< 0.01	NA
82 A-36	8/17/93	28.50 28.80	< 0.01	< 0.01	< 0.01	< 0.01	< 0.01	NA	< 0.01	<0.01	<0.01	< 0.01	< 0.01	< 0.01	NA
82 A-35	8/17/93	28.80 29.10	< 0.01	< 0.01	< 0.01	< 0.01	< 0.01	NA	< 0.01	<0.01	<0.01	< 0.01	< 0.01	< 0.01	NA
82 A-34	8/17/93	29.10 29.40	< 0.01	< 0.01	< 0.01	< 0.01	< 0.01	NA	< 0.01	<0.01	<0.01	< 0.01	< 0.01	< 0.01	NA
82 A-33	8/17/93	29.40 29.70	< 0.01	< 0.01	< 0.01	< 0.01	< 0.01	NA	< 0.01	<0.01	<0.01	< 0.01	< 0.01	< 0.01	NA
82 A-32	8/17/93	29.70 30.00	< 0.01	< 0.01	< 0.01	< 0.01	< 0.01	NA	< 0.01	<0.01	<0.01	< 0.01	< 0.01	< 0.01	NA
82 A-31	8/17/93	30.00 30.30	< 0.01	< 0.01	< 0.01	< 0.01	< 0.01	NA	< 0.01	<0.01	<0.01	< 0.01	< 0.01	< 0.01	NA
82 A-30	8/17/93	30.30 30.60	< 0.01	< 0.01	< 0.01	< 0.01	< 0.01	NA	< 0.01	<0.01	<0.01	< 0.01	< 0.01	< 0.01	NA
82 A-29	8/17/93	30.60 30.90	< 0.01	< 0.01	< 0.01	< 0.01	< 0.01	NA	< 0.01	<0.01	<0.01	< 0.01	< 0.01	< 0.01	NA

TABLE 4.2 (Continued)

**FUEL HYDROCARBON COMPOUNDS DETECTED IN SOIL
UST SITE 870 INTRINSIC REMEDIATION EE/CA
HILL AFB, UTAH**

Sample Location	Sample Date	Sample Interval Top (ft bgs)	Bottom (ft bgs)	Benzene (mg/kg)	Toluene (mg/kg)	Ethylbenzene (mg/kg)	P-Xylene (mg/kg)	M-Xylene (mg/kg)	M&P- Xylene (mg/kg)	O-Xylene (mg/kg)	Total Xylenes (mg/kg)	Total BTEX (mg/kg)	1,3,5- TMB (mg/kg)	1,2,4- TMB (mg/kg)	1,2,3- TMB (mg/kg)	TPH (mg/kg)
82 A-28	8/17/93	30.90	31.20	< 0.01	< 0.01	< 0.01	< 0.01	< 0.01	NA	< 0.01	<0.01	<0.01	< 0.01	< 0.01	< 0.01	NA
82 A-27	8/17/93	31.20	31.50	< 0.01	< 0.01	< 0.01	< 0.01	< 0.01	NA	< 0.01	<0.01	<0.01	< 0.01	< 0.01	< 0.01	NA
82 A-54	8/17/93	31.50	31.80	< 0.01	< 0.01	< 0.01	< 0.01	< 0.01	NA	< 0.01	<0.01	<0.01	< 0.01	< 0.01	< 0.01	NA
82 A-53	8/17/93	31.80	32.10	< 0.01	< 0.01	< 0.01	< 0.01	< 0.01	NA	< 0.01	<0.01	<0.01	< 0.01	< 0.01	< 0.01	NA
82 A-52	8/17/93	32.10	32.40	< 0.01	< 0.01	< 0.01	< 0.01	< 0.01	NA	< 0.01	<0.01	<0.01	< 0.01	< 0.01	< 0.01	NA
82 A-51	8/17/93	32.40	32.70	< 0.01	< 0.01	< 0.01	< 0.01	< 0.01	NA	< 0.01	<0.01	<0.01	< 0.01	< 0.01	< 0.01	NA
82 A-50	8/17/93	32.70	33.00	< 0.01	< 0.01	< 0.01	< 0.01	< 0.01	NA	< 0.01	<0.01	<0.01	< 0.01	< 0.01	< 0.01	NA
82 A-49	8/17/93	33.00	33.30	< 0.01	< 0.01	< 0.01	< 0.01	< 0.01	NA	< 0.01	<0.01	<0.01	< 0.01	< 0.01	< 0.01	NA
82 A-48	8/17/93	33.30	33.60	< 0.01	< 0.01	< 0.01	< 0.01	< 0.01	NA	< 0.01	<0.01	<0.01	< 0.01	< 0.01	< 0.01	NA
82 A-47	8/17/93	33.60	33.90	< 0.01	< 0.01	< 0.01	< 0.01	< 0.01	NA	< 0.01	<0.01	<0.01	< 0.01	< 0.01	< 0.01	NA
82 A-46	8/17/93	33.90	34.20	< 0.01	< 0.01	< 0.01	< 0.01	< 0.01	NA	< 0.01	<0.01	<0.01	< 0.01	< 0.01	< 0.01	NA
82 A-45	8/17/93	34.20	34.50	< 0.01	< 0.01	< 0.01	< 0.01	< 0.01	NA	< 0.01	<0.01	<0.01	< 0.01	< 0.01	< 0.01	NA
82 A-44	8/17/93	34.50	34.80	< 0.01	< 0.01	< 0.01	< 0.01	< 0.01	NA	< 0.01	<0.01	<0.01	< 0.01	< 0.01	< 0.01	NA
82 A-43	8/17/93	34.80	35.10	< 0.01	< 0.01	< 0.01	< 0.01	< 0.01	NA	< 0.01	<0.01	<0.01	< 0.01	< 0.01	< 0.01	NA
82 A-42	8/17/93	35.10	35.40	< 0.01	< 0.01	< 0.01	< 0.01	< 0.01	NA	< 0.01	<0.01	<0.01	< 0.01	< 0.01	< 0.01	NA
82 B-12	8/18/93	20.00	20.30	< 0.01	< 0.01	< 0.01	< 0.01	< 0.01	NA	< 0.01	<0.01	<0.01	< 0.01	< 0.01	< 0.01	NA
82 B-11	8/18/93	20.30	20.60	< 0.01	< 0.01	< 0.01	< 0.01	< 0.01	NA	< 0.01	<0.01	<0.01	< 0.01	< 0.01	< 0.01	NA
82 B-10	8/18/93	20.60	20.90	< 0.01	< 0.01	< 0.01	< 0.01	< 0.01	NA	< 0.01	<0.01	<0.01	< 0.01	< 0.01	< 0.01	NA
82 B-09	8/18/93	20.90	21.20	< 0.01	< 0.01	< 0.01	< 0.01	< 0.01	NA	< 0.01	<0.01	<0.01	< 0.01	< 0.01	< 0.01	NA
82 B-08	8/18/93	21.20	21.50	< 0.01	< 0.01	< 0.01	< 0.01	< 0.01	NA	< 0.01	<0.01	<0.01	< 0.01	< 0.01	< 0.01	NA
82 B-07	8/18/93	21.50	21.80	< 0.01	< 0.01	< 0.01	< 0.01	< 0.01	NA	< 0.01	<0.01	<0.01	< 0.01	< 0.01	< 0.01	NA
82 B-06	8/18/93	21.80	22.10	< 0.01	< 0.01	< 0.01	< 0.01	< 0.01	NA	< 0.01	<0.01	<0.01	< 0.01	< 0.01	< 0.01	NA
82 B-05	8/18/93	22.10	22.40	< 0.01	< 0.01	< 0.01	< 0.01	< 0.01	NA	< 0.01	<0.01	<0.01	< 0.01	< 0.01	< 0.01	NA
82 B-04	8/18/93	22.40	22.70	< 0.01	< 0.01	< 0.01	< 0.01	< 0.01	NA	< 0.01	<0.01	<0.01	< 0.01	< 0.01	< 0.01	NA
82 B-02	8/18/93	22.70	23.00	< 0.01	< 0.01	< 0.01	< 0.01	< 0.01	NA	< 0.01	<0.01	<0.01	< 0.01	< 0.01	< 0.01	NA
82 B-01	8/18/93	23.00	23.30	< 0.01	< 0.01	< 0.01	< 0.01	< 0.01	NA	< 0.01	<0.01	<0.01	< 0.01	< 0.01	< 0.01	NA
NSN	8/18/93	23.30	23.60	< 0.01	< 0.01	< 0.01	< 0.01	< 0.01	NA	< 0.01	< 0.01	< 0.01	< 0.01	< 0.01	< 0.01	NA
NSN	8/18/93	23.60	23.90	< 0.01	< 0.01	< 0.01	< 0.01	< 0.01	NA	< 0.01	< 0.01	< 0.01	< 0.01	< 0.01	< 0.01	NA
82 B-24	8/18/93	23.90	24.10	< 0.01	< 0.01	< 0.01	< 0.01	< 0.01	NA	< 0.01	<0.01	<0.01	< 0.01	< 0.01	< 0.01	NA
82 B-23	8/18/93	24.10	24.40	< 0.01	< 0.01	< 0.01	< 0.01	< 0.01	NA	< 0.01	<0.01	<0.01	< 0.01	< 0.01	< 0.01	NA
82 B-22	8/18/93	24.40	24.70	< 0.01	< 0.01	< 0.01	< 0.01	< 0.01	NA	< 0.01	<0.01	<0.01	< 0.01	< 0.01	< 0.01	NA
82 B-21	8/18/93	24.70	25.00	< 0.01	< 0.01	< 0.01	< 0.01	< 0.01	NA	< 0.01	<0.01	<0.01	< 0.01	< 0.01	< 0.01	NA
82 B-20	8/18/93	25.00	25.30	< 0.01	< 0.01	< 0.01	< 0.01	< 0.01	NA	< 0.01	<0.01	<0.01	< 0.01	< 0.01	< 0.01	NA
82 B-19	8/18/93	25.30	25.60	< 0.01	< 0.01	< 0.01	< 0.01	< 0.01	NA	< 0.01	<0.01	<0.01	< 0.01	< 0.01	< 0.01	NA
82 B-18	8/18/93	25.60	25.90	< 0.01	< 0.01	< 0.01	< 0.01	< 0.01	NA	< 0.01	<0.01	<0.01	< 0.01	< 0.01	< 0.01	NA
82 B-17	8/18/93	25.90	26.10	< 0.01	< 0.01	< 0.01	< 0.01	< 0.01	NA	< 0.01	<0.01	<0.01	< 0.01	< 0.01	< 0.01	NA
82 B-16	8/18/93	26.10	26.40	< 0.01	< 0.01	< 0.01	< 0.01	< 0.01	NA	< 0.01	<0.01	<0.01	< 0.01	< 0.01	< 0.01	NA
82 B-15	8/18/93	26.40	26.70	< 0.01	< 0.01	< 0.01	< 0.01	< 0.01	NA	< 0.01	<0.01	<0.01	< 0.01	< 0.01	< 0.01	NA

TABLE 4.2 (Continued)

**FUEL HYDROCARBON COMPOUNDS DETECTED IN SOIL
UST SITE 870 INTRINSIC REMEDIATION EE/CA
HILL AFB, UTAH**

Sample Location	Sample Date	Sample Interval Top (ft bgs)	Sample Interval Bottom (ft bgs)	Benzene (mg/kg)	Toluene (mg/kg)	Ethylbenzene (mg/kg)	P-Xylene (mg/kg)	M-Xylene (mg/kg)	M&P-Xylene (mg/kg)	O-Xylene (mg/kg)	Total Xylenes (mg/kg)	Total BTEX (mg/kg)	1,3,5-TMB (mg/kg)	1,2,4-TMB (mg/kg)	1,2,3-TMB (mg/kg)	TPH (mg/kg)
82 B-14	8/18/93	26.70	27.10	< 0.01	< 0.01	< 0.01	< 0.01	< 0.01	NA	< 0.01	< 0.01	< 0.01	< 0.01	< 0.01	< 0.01	NA
82 B-13	8/18/93	27.10	27.40	< 0.01	< 0.01	< 0.01	< 0.01	< 0.01	NA	< 0.01	< 0.01	< 0.01	< 0.01	< 0.01	< 0.01	NA
82 C-26	8/18/93	19.90	20.20	BLQ1	BLQ1	0.0118	0.0178	0.0418	NA	0.00716	0.06676	0.07856	0.029	0.0371	0.0145	< 10.0
82 C-25	8/18/93	20.20	20.50	BLQ1	BLQ1	0.0124	0.0221	0.0521	NA	0.0136	0.0878	0.1002	0.0388	0.054	0.0229	< 10.0
82 C-24	8/18/93	20.50	20.80	BLQ1	BLQ1	0.00795	0.0105	0.0189	NA	BLQ1	0.0294	0.03735	0.0148	0.0168	0.00363	< 10.0
82 C-23	8/18/93	20.80	21.10	BLQ1	BLQ1	0.00642	0.011	0.00991	NA	BLQ1	0.0294	0.02733	0.0801	0.0741	0.00813	< 10.0
82 C-22	8/18/93	21.10	21.40	0.00327	0.02	0.0286	0.0857	0.0662	NA	BLQ1	0.1519	0.20377	3.7	4.42	0.905	352
82 C-21	8/18/93	21.40	21.55	0.00367	0.0192	0.00558	0.0365	0.00956	NA	BLQ1	0.04606	0.07451	2.34	2.04	0.208	173
82 C-20	8/18/93	21.55	21.70	< 0.01	0.0176	0.00618	0.0296	0.0091	NA	0.00401	0.04271	0.06649	1.5	1.03	0.0553	580(EST)
82 C-19	8/18/93	21.70	22.00	0.00621	< 0.01	0.018	0.042	0.0257	NA	0.0151	0.0828	0.10701	1.65	1.16	0.108	444
82 C-16	8/18/93	22.10	22.30	< 0.01	< 0.01	< 0.01	< 0.01	< 0.01	NA	< 0.01	< 0.01	< 0.01	0.0139	0.0167	0.00491	< 10.0
82 C-14	8/18/93	22.30	22.60	< 0.01	< 0.01	< 0.01	< 0.01	< 0.01	NA	< 0.01	< 0.01	< 0.01	< 0.01	< 0.01	< 0.01	< 10.0
82 D-06	8/20/93	21.50	21.80	BLQ1	BLQ1	< 0.01	< 0.01	< 0.01	NA	< 0.01	< 0.01	< 0.01	< 0.01	< 0.01	< 0.01	NA
82 D-05	8/20/93	21.80	22.10	BLQ1	BLQ1	BLQ1	BLQ1	< 0.01	NA	BLQ1	BLQ1	BLQ1	BLQ1	0.00498	BLQ1	< 10.0
82 D-04	8/20/93	22.10	22.40	BLQ1	BLQ1	0.00871	0.0136	0.0345	NA	0.00451	0.05261	0.06132	0.195	0.225	0.0548	< 10.0
82 D-03	8/20/93	22.40	22.80	< 0.01	BLQ1	0.00335	BLQ1	0.00336	NA	BLQ1	0.00336	0.00671	0.0174	0.00885	0.00311	< 10.0
82 D-01	8/20/93	23.80	24.00	0.00959	BLQ1	0.0159	BLQ1	BLQ1	NA	BLQ1	BLQ1	0.02549	0.00416	BLQ1	BLQ1	< 10.0
82 D-25	8/20/93	24.00	24.10	0.0103	BLQ1	0.0106	0.00575	0.0143	NA	0.00359	0.02364	0.04454	0.00744	0.00702	BLQ1	NA
82 D-24	8/20/93	24.10	24.40	0.129	BLQ1	0.264	0.276	0.555	NA	0.144	0.975	1.368	0.373	0.44	0.135	< 10.0
82 D-23	8/20/93	24.40	24.70	0.271	BLQ1	1.48	1.62	3.4	NA	0.732	5.752	7.503	2.53	3.11	0.817	< 10.0
82 D-22	8/20/93	24.70	25.00	0.0697	BLQ1	0.111	0.013	BLQ1	NA	BLQ1	0.013	0.1937	0.0304	0.0111	BLQ1	< 10.0
82 D-21	8/20/93	25.00	25.30	0.0104	BLQ1	0.0949	BLQ1	0.00303	NA	BLQ1	0.00303	0.10833	0.00477	0.0031	< 0.01	NA
82 D-19	8/20/93	25.60	25.90	0.00829	BLQ1	0.0604	0.0388	0.00529	NA	0.00577	0.04986	0.11855	0.0882	0.078	0.00821	NA
82 D-18	8/20/93	25.90	26.20	0.00792	BLQ1	0.0344	BLQ1	BLQ1	NA	BLQ1	BLQ1	0.03232	0.0258	BLQ1	< 0.01	NA
82 D-17	8/20/93	26.20	26.50	0.0063	BLQ1	0.0213	BLQ1	BLQ1	NA	BLQ1	BLQ1	0.0276	0.0147	BLQ1	< 0.01	< 10.0
82 D-16	8/20/93	26.50	26.80	0.0316	0.00304	0.0613	0.0551	0.181	NA	0.045	0.2811	0.37704	0.0365	0.0399	0.0213	< 10.0
82 D-15	8/20/93	26.80	27.00	0.0343	BLQ1	0.0878	0.039	0.121	NA	0.0323	0.1923	0.3144	0.0433	0.0303	0.0127	< 10.0
82 D-14	8/20/93	27.00	27.30	0.0209	BLQ1	0.124	0.0662	0.0194	NA	BLQ1	0.0856	0.2305	0.0637	0.0695	0.00518	< 10.0
82 D-13	8/20/93	27.30	27.60	0.0185	BLQ1	0.141	0.00755	0.0275	NA	0.00476	0.03981	0.19931	0.00871	0.00572	BLQ1	NA
82 D-12	8/20/93	27.60	27.80	0.0203	BLQ1	0.115	0.00454	0.0167	NA	BLQ1	0.02124	0.15654	0.00632	0.00416	BLQ1	NA
82 D-40	8/20/93	28.00	28.20	0.0314	BLQ1	0.171	0.0378	0.111	NA	0.0242	0.173	0.3754	0.0439	0.0373	0.0163	NA
82 D-39	8/20/93	28.20	28.50	0.0388	BLQ1	0.137	BLQ1	0.00404	NA	0.00486	0.0189	0.1847	0.0077	BLQ1	BLQ1	NA
82 D-38	8/20/93	28.50	28.80	0.0393	0.00809	0.128	0.0105	0.101	NA	0.0692	0.1807	0.35609	0.0733	0.0107	0.0384	NA
82 E-03	8/21/93	2.70	3.00	< 0.01	< 0.01	< 0.01	< 0.01	< 0.01	NA	< 0.01	< 0.01	< 0.01	< 0.01	< 0.01	< 0.01	NA
82 E-02	8/21/93	3.00	3.30	< 0.01	< 0.01	< 0.01	< 0.01	< 0.01	NA	< 0.01	< 0.01	< 0.01	< 0.01	< 0.01	< 0.01	NA
82 E-17	8/21/93	4.90	5.25	< 0.01	< 0.01	< 0.01	< 0.01	< 0.01	NA	< 0.01	< 0.01	< 0.01	< 0.01	< 0.01	< 0.01	NA

TABLE 4.2 (Continued)

FUEL HYDROCARBON COMPOUNDS DETECTED IN SOIL
UST SITE 870 INTRINSIC REMEDIATION EE/CA
HILL AFB, UTAH

Sample Location	Sample Date	Sample Interval Top (ft bgs)	Sample Interval Bottom (ft bgs)	Benzene (mg/kg)	Toluene (mg/kg)	Ethylbenzene (mg/kg)	P-Xylene (mg/kg)	M-Xylene (mg/kg)	M&P- Xylene (mg/kg)	O-Xylene (mg/kg)	Total Xylenes (mg/kg)	Total BTEX (mg/kg)	1,3,5- TMB (mg/kg)	1,2,4- TMB (mg/kg)	1,2,3- TMB (mg/kg)	TPH (mg/kg)
82 E-15	8/21/93	5.60	5.95	< 0.01	< 0.01	< 0.01	< 0.01	< 0.01	NA	< 0.01	< 0.01	< 0.01	< 0.01	< 0.01	< 0.01	NA
82 E-14	8/21/93	5.95	6.30	< 0.01	< 0.01	< 0.01	< 0.01	< 0.01	NA	< 0.01	< 0.01	< 0.01	< 0.01	< 0.01	< 0.01	NA
82 E-13	8/21/93	6.30	6.65	< 0.01	< 0.01	< 0.01	< 0.01	< 0.01	NA	< 0.01	< 0.01	< 0.01	< 0.01	< 0.01	< 0.01	NA
82 I-14	8/22/93	13.80	14.00	< 0.01	BLQ1	BLQ1	BLQ1	BLQ1	NA	BLQ1	< 0.01	< 0.01	BLQ1	BLQ1	BLQ1	NA
82 I-13	8/22/93	14.00	14.40	BLQ1	BLQ1	BLQ1	BLQ1	BLQ1	NA	BLQ1	BLQ1	BLQ1	BLQ1	BLQ1	< 0.01	NA
82 I-12	8/22/93	14.40	14.80	BLQ1	BLQ1	BLQ1	BLQ1	0.00543	NA	BLQ1	0.00543	0.00543	BLQ1	BLQ1	BLQ1	NA
82 I-11	8/22/93	14.80	15.20	BLQ1	BLQ1	BLQ1	BLQ1	BLQ1	NA	BLQ1	BLQ1	BLQ1	BLQ1	BLQ1	BLQ1	NA
82 I-10	8/22/93	15.20	15.56	< 0.01	BLQ1	BLQ1	BLQ1	0.00408	NA	BLQ1	0.00408	0.00408	BLQ1	BLQ1	BLQ1	NA
82 I-09	8/22/93	15.56	15.92	BLQ1	BLQ1	BLQ1	BLQ1	BLQ1	NA	BLQ1	BLQ1	BLQ1	BLQ1	BLQ1	BLQ1	NA
82 I-08	8/22/93	15.92	16.28	BLQ1	BLQ1	BLQ1	BLQ1	BLQ1	NA	BLQ1	BLQ1	BLQ1	BLQ1	BLQ1	< 0.01	NA
82 I-07	8/22/93	16.28	16.64	BLQ1	BLQ1	BLQ1	BLQ1	BLQ1	NA	BLQ1	BLQ1	BLQ1	BLQ1	BLQ1	BLQ1	138
82 I-06	8/22/93	16.64	17.00	BLQ1	BLQ1	BLQ1	BLQ1	BLQ1	NA	BLQ1	BLQ1	BLQ1	BLQ1	BLQ1	BLQ1	139
82 I-05	10/21/93	17.00	17.36	0.0326	0.0266	14.5	19.9	52.7	NA	18.2	90.8	105.3592	28.1	49.9	18.5	3530
82 I-05	9/1/93	17.00	17.36	1.61	0.204	11.2	23.4	63.1	NA	19.9	106.4	119.414	29.3	50.9	19.3	NA
82 I-04	8/22/93	17.36	17.72	0.517	0.235	4.83	22.3	62.3	NA	20.8	105.4	110.482	23.3	42.7	15.4	11500
82 I-03	8/22/93	17.72	18.08	4.55	2.73	47.7	105	294	NA	100	499	553.98	88.8	167	59.2	28300
82 I-02	8/22/93	18.08	18.44	0.401	12.6	17.5	34.4	99.3	NA	36.6	170.3	200.801	36.8	69.8	25.3	5160
82 I-01	8/22/93	18.44	18.80	BLQ1	0.142	0.556	1.22	3.67	NA	1.61	6.5	7.198	2.3	4.43	1.71	6080
82 I-27	8/22/93	18.80	19.12	0.49	1.73	0.377	0.625	1.84	NA	0.725	3.19	5.787	0.384	0.724	0.272	< 10.0
82 I-26	8/22/93	19.12	19.45	0.749	3.75	1.03	1.7	4.74	NA	2.04	8.48	14.009	1.24	2.54	0.958	< 10.0
82 I-25	8/22/93	19.45	19.77	0.866	0.231	0.187	0.281	0.802	NA	0.403	1.486	2.77	0.103	0.244	0.0909	< 10.0
82 I-24	8/22/93	19.77	20.09	0.787	0.159	0.15	0.228	0.616	NA	0.31	1.154	2.25	0.0743	0.195	0.0749	< 10.0
82 I-23	8/22/93	20.09	20.42	1.45	0.2	0.283	0.427	1.16	NA	0.567	2.154	4.087	0.157	0.402	0.155	< 10.0
82 I-22	8/22/93	20.42	20.74	0.771	0.0936	0.15	0.233	0.621	NA	0.318	1.172	2.1866	0.0938	0.246	0.0899	< 10.0
82 I-21	8/22/93	20.74	21.06	0.665	0.035	0.159	0.233	0.612	NA	0.321	1.166	2.025	0.0796	0.206	0.0783	NA
82 I-20	8/22/93	21.06	21.38	0.538	0.0436	0.152	0.221	0.604	NA	0.303	1.128	1.8616	0.0747	0.191	0.0709	NA
82 I-19	8/22/93	21.38	21.71	0.678	0.0455	0.16	0.243	0.517	NA	0.316	1.076	1.9595	0.0843	0.222	0.0778	NA
82 I-18	8/22/93	21.71	22.03	0.629	0.117	1.31	2.02	0.988	NA	2.31	5.318	7.374	1.62	4.72	1.25	276
82 I-17	8/22/93	22.03	22.35	0.653	0.591	3.39	4.69	4.89	NA	5.28	14.86	19.494	3.04	8.37	2.34	856(EST)
82 I-16	8/22/93	22.35	22.68	0.333	0.304	1.12	1.48	1.83	NA	1.72	5.03	6.87	0.857	2.33	0.672	< 10.0
82 I-15	8/22/93	22.68	23.00	0.501	1.07	3.72	4.81	10.5	NA	5.58	20.89	26.181	2.94	8.45	2.03	643
82 I-39	8/22/93	23.00	23.20	0.422	0.0674	1.31	1.75	2.28	NA	1.03	5.06	6.8594	1.27	3.3	0.823	< 10.0
82 I-38	8/22/93	23.20	23.40	0.315	0.0188	0.121	0.154	0.0592	NA	0.129	0.3422	0.797	0.031	0.113	0.031	< 10.0
82 I-37	8/22/93	23.40	23.76	0.712	0.182	2.72	3.96	7.86	NA	4.79	16.61	20.224	2.32	5.38	1.5	340
82 I-36	8/22/93	23.76	24.12	0.0812	0.0154	0.0238	0.0364	0.0898	NA	0.085	0.2112	0.3316	0.0121	17.2	0.00937	< 10.0
82 I-35	8/22/93	24.12	24.48	0.00831	0.0137	BLQ1	BLQ1	< 0.01	NA	BLQ1	0	0.02201	BLQ1	BLQ1	< 0.01	< 10.0
82 I-34	8/22/93	24.48	24.84	< 0.01	0.0073	16.1	< 0.01	< 0.01	NA	< 0.01	0	16.1073	< 0.01	< 0.01	< 0.01	< 10.0
82 I-33	8/22/93	24.84	25.20	< 0.01	0.0122	27.1	< 0.01	< 0.01	NA	< 0.01	0	27.1122	BLQ1	BLQ1	< 0.01	< 10.0

TABLE 4.2 (Concluded)

**FUEL HYDROCARBON COMPOUNDS DETECTED IN SOIL
UST SITE 870 INTRINSIC REMEDIATION EE/CA
HILL AFB, UTAH**

Sample Location	Sample Date	Sample Interval Top (ft bgs)	Bottom (ft bgs)	Benzene (mg/kg)	Toluene (mg/kg)	Ethylbenzene (mg/kg)	P-Xylene (mg/kg)	M-Xylene (mg/kg)	M&P-Xylene (mg/kg)	O-Xylene (mg/kg)	Total Xylenes (mg/kg)	Total BTEX (mg/kg)	1,3,5-TMB (mg/kg)	1,2,4-TMB (mg/kg)	1,2,3-TMB (mg/kg)	TPH (mg/kg)
82 I-32	8/22/93	25.20	25.56	0.0136	0.032	1.24	1.05	1.79	NA	0.0376	2.8776	4.1632	13.1	7.62	3.09	410(EST)
82 I-31	8/22/93	25.56	25.92	< 0.01	0.0114	0.101	< 0.01	0.0128	NA	BLQ1	0.0128	0.1252	0.418	0.0191	0.259	< 10.0
82 I-29	8/22/93	26.28	26.64	< 0.01	0.0157	BLQ1	BLQ1	BLQ1	NA	BLQ1	0	0.0157	BLQ1	BLQ1	BLQ1	NA
82 I-28	8/22/93	26.64	27.00	< 0.01	0.0168	BLQ1	BLQ1	0.00884	NA	BLQ1	0.00884	0.02564	BLQ1	0.00524	BLQ1	NA
82 I-30	8/22/93			< 0.01	0.0111	BLQ1	BLQ1	BLQ1	NA	BLQ1	0	0.0111	BLQ1	BLQ1	BLQ1	NA
MW-08	6/18/92	11.00	11.50	< 0.005	0.031	0.12	NA	NA	NA	NA	0.92	0.963	NA	NA	NA	110
MW-05	6/17/92	15.50	16.00	2	0.11	0.26	NA	NA	NA	NA	2.8	5.17	NA	NA	NA	20
MW-01	11/6/91	16.00	17.00	0.15	0.129	0.057	NA	NA	0.203	0.115	0.318	0.654	NA	NA	NA	< 10.0
MW-01A	6/29/92	17.00	17.50	10	23	16	NA	NA	NA	NA	74	123	NA	NA	NA	1500
MW-01		18.00	19.00	0.564	0.145	0.341	NA	NA	1.64	0.609	2.249	3.299	NA	NA	NA	98.3
MW-06	6/17/92	21.00	21.50	0.009	< 0.005	< 0.005	NA	NA	NA	NA	< 0.01	0.009	NA	NA	NA	< 10.0
MW-01A	7/1/92	59.50	60.00	< 0.005	< 0.005	< 0.005	NA	NA	NA	NA	< 0.01	0	NA	NA	NA	< 10.0
MW-09	6/29/92	17.00	17.50	0.1	0.1	0.18	NA	NA	NA	NA	5.4	5.78	NA	NA	NA	360
SB870A-03	11/7/91	11.00	12.00	9.4	115	66.7	NA	NA	494	140	634	2.214	NA	NA	NA	2790
SB870A-02	11/7/91	15.00	16.00	0.0432	0.0513	0.0522	NA	NA	0.365	0.0923	0.4573	0.6399	NA	NA	NA	23.2
SB870A-02	11/7/91	17.00	18.00	0.013	0.0602	0.0577	NA	NA	0.386	0.123	0.509	0.604	NA	NA	NA	37
SB870A-03	11/7/91	19.00	20.00	0.338	0.595	0.138	NA	NA	0.867	0.276	1.143	825.1	NA	NA	NA	< 10.0
SB870A-03 d	11/7/91	19.00	20.00	22.2	187	83.1	NA	NA	567	177	744	1036.3	NA	NA	NA	15100

* All samples with an 82 prefix are from EPA-82 series wells

See Appendix C for analytical methods

BLQ1 = Detected Below Limit of Quantification of 0.01 µg/mL

NA = Sample not analyzed for this parameter

EST = Estimated value reported by lab

NSN = No sample number



LEGEND

- ▲ CONE PENETROMETER TEST POINT/
PIEZOMETER
- MW-11 ● MONITORING WELL LOCATION
- ⊙ AUGUST 1993 GEOPROBE SAMPLING
LOCATION
- STORM DRAIN SURVEY LOCATION
- JULY 1994 GEOPROBE SAMPLING
LOCATION
- ◆ JULY 1994 SOIL BORING LOCATION
- 1.00 — LINE OF EQUAL BTEX
CONCENTRATION (mg/kg)
DRAWN AT INTERNAL OF GREATEST
CONCENTRATION
- ND NOT DETECTED (<0.01 mg/kg)
CONTOUR INTERVAL = VARIABLE

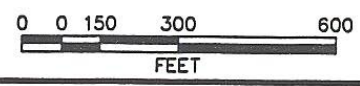
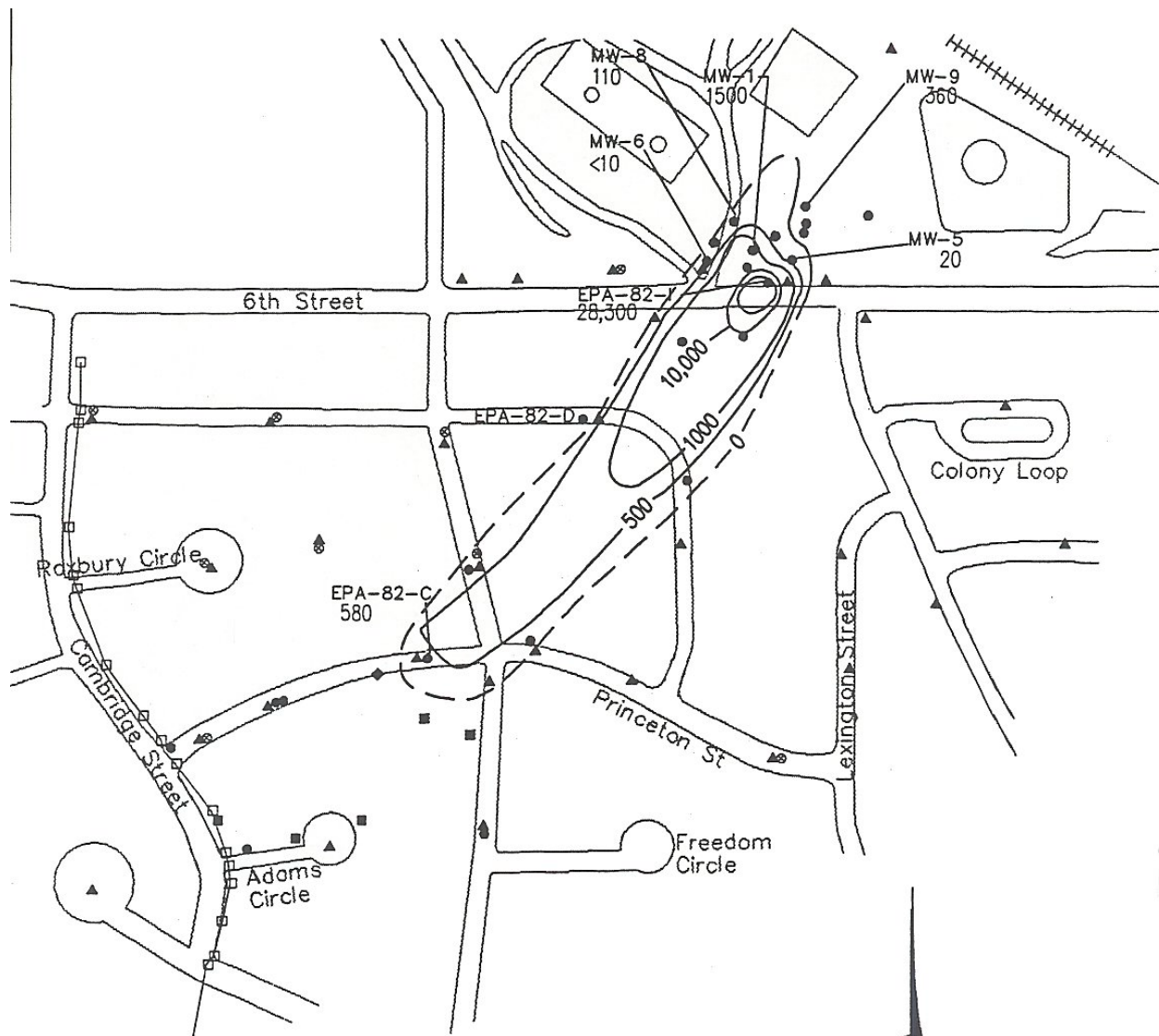

FIGURE 4.2
**TOTAL BTEX ISOPLETH
FOR SOIL**

UST Site 870
Intrinsic Remediation EE/CA
Hill Air Force Base, Utah

**PARSONS
ENGINEERING SCIENCE, INC.**

Denver, Colorado



LEGEND

- CPT-26 ▲ CONE PENETROMETER TEST POINT/
PIEZOMETER
- MW-11 ● MONITORING WELL LOCATION
- AUGUST 1993 GEOPROBE SAMPLING
LOCATION
- STORM DRAIN SURVEY LOCATION
- EPA-82-M ■ JULY 1994 GEOPROBE SAMPLING
LOCATION
- EPA-82-KK ◆ JULY 1994 SOIL BORING LOCATION
- 500 — LINE OF EQUAL TOTAL PETROLEUM
HYDROCARBON CONCENTRATION (mg/kg)
(DASHED WHERE INFERRED)

FIGURE 4.3
**TOTAL PETROLEUM
HYDROCARBON ISOPLETH
MAP FOR SOIL**

UST Site 870
Intrinsic Remediation EE/CA
Hill Air Force Base, Utah

**PARSONS
ENGINEERING SCIENCE, INC.**
Denver, Colorado

EPA-82-I, which is in the vicinity of the initial fuel release into the soil. This 7-foot-thick zone of elevated TPH concentrations extends above and below the ground water table. Downgradient areas with residual-phase contamination have TPH levels as high as 580 mg/kg, but the contaminated zones are less than 1 foot thick. Theoretically, because BTEX is a subset of TPH, the areas of BTEX and TPH contamination should be the same. However, because of the higher detection limit associated with the TPH analytical method, the area of detected TPH is slightly smaller than the area with elevated BTEX concentrations at this site.

4.2.3 Total Organic Carbon

TOC concentrations are used to estimate the amount of organic matter sorbed on soil particles or trapped in the interstitial passages of a soil matrix. The TOC concentration in the saturated zone is an important parameter used to estimate the amount of contaminant that could potentially be sorbed to the aquifer matrix. Sorption results in slowing (retardation) of the contaminant plume relative to the average advective ground water velocity. Background measurements of TOC were taken from core samples obtained from soil boring EPA-82-E. The TOC in the soil at this point ranges from 0.069 to 0.094 percent (Table 4.3).

TABLE 4.3
TOTAL ORGANIC CARBON IN SOIL
UST SITE 870 INTRINSIC REMEDIATION EE/CA
HILL AFB, UTAH

Sample Location	Soil Filtrate (% OC)	Solids (% OC)	Total Soil (% OC)	Mean + 1 Standard Deviation Soil % TOC
82E-12-1	0.007	0.046	0.053	0.069+0.019
82E-12-2	0.009	0.056	0.065	
82E-12-3	0.007	0.083	0.09	
82E-14-1	0.007	0.074	0.081	0.070+0.011
82E-14-2	0.006	0.062	0.068	
82E-14-3	0.006	0.054	0.06	
82E-15-1	0.014	0.071	0.085	0.087+0.004
82E-15-2	0.018	0.074	0.092	
82E-15-3	0.012	0.073	0.085	
82E-17-1	0.011	0.101	0.112	0.094+0.017
82E-17-2	0.011	0.078	0.089	
82E-17-3	0.012	0.068	0.08	
LECO STANDARD DEVIATION SOIL		1.022		
		1.034		
LECO STANDARD DEVIATION SOIL T.V.		1.00+0.04		

a/ feet bgs = feet below ground surface

Soil TOC samples were collected just below the phreatic surface for accurate estimates of TOC in the shallow saturated zone. EPA-82-E was selected as a TOC sampling location because it was located outside of mobile or residual LNAPL contaminated soils (which would compromise TOC readings) and directly downgradient of potential plume migration. As a result, the soil TOC at EPA-82-E is indicative of the potential sorptive potential in the shallow aquifer directly downgradient of anticipated plume migration. The TOC estimate compares favorably with literature values defining TOC contents in relatively clean, sandy soils (0.01 percent TOC).

4.3 GROUND WATER CHEMISTRY

4.3.1 Dissolved-Phase BTEX Contamination

Laboratory analytical results for ground water samples collected during previous site investigations indicated the presence of fuel-hydrocarbon contamination in the shallow saturated zone in the vicinity of UST Site 870. Ground water samples collected in August 1993 by Parsons ES and RSKERL personnel confirmed these results. Additional ground water samples collected in July 1994 suggest that natural attenuation of BTEX compounds is occurring at this site. Table 4.4 summarizes available ground water contaminant data. Two ground water samples from the site appear to have unrealistically high total BTEX concentrations ranging from 52.7 mg/L (TP-07 = CPT-07) to 14,400 mg/L (CPT-14). The work of Smith *et al.* (1981) suggests that the maximum dissolved-phase BTEX concentration that can result from the equilibrium partitioning of BTEX compounds from JP-4 into ground water is approximately 30 mg/L. Unrealistically high total BTEX concentrations generally result from LNAPL emulsification during sampling. The highest dissolved-phase total BTEX concentration observed at the site that can be considered reliable is 26,576 µg/L. This sample was collected from well MW-03 in August, 1992. This well contained mobile LNAPL but this total BTEX concentration is within the range suggested by Smith *et al.* (1981) and is consistent with samples collected from other wells containing mobile LNAPL (EPA-82-I = 21,475 µg/L and EPA-82-J = 16,336 µg/L).

To evaluate trends in BTEX loss over the site, data sets from different sampling periods were combined to form BTEX isopleth maps for 1993 and 1994 (described in preceding paragraphs). Although generally not a concern, the various ground water analytical methods used to sample ground water from different site characterization studies (1992 to 1994) were judged for their quantitative comparability. Method RSKOP-124 was used by Parsons ES to quantitate aqueous BTEX concentrations during August 1993 and 1994 sampling events. RSKOP-124 is a dual-column, gas-chromatograph/mass spectroscopy (GC/MS) technique that has resolution capabilities that are superior to EPA SW-846 Methods 8020/602, 8015M, and 8240 (used for

volatile and semi-volatile organic analysis by JMM in 1992). All analytical techniques used for VOC analysis in the different site characterization studies from 1992 to 1994 had identical, achievable detection limits of 1 µg/L and adequate compound resolution capabilities. Hence, comparison of different ground water data sets are not compromised by underestimation or overestimation of a particular analytical technique. Groundwater extraction and preparation techniques used by JMM in 1992 are not available; however, potential differences in sampling technique were to be minor because ground water sampling techniques are fairly standardized.

Figure 4.4 is an isopleth map that shows the distribution of total BTEX dissolved in ground water through August 1993. Because this figure was used for Bioplume II model input (to be conservative) the highest total BTEX concentrations observed in ground water between August 1992 and August 1993 were used to prepare this figure. This figure also includes data collected from monitoring wells in the source area north of Sixth Street in December 1993/January 1994 (MW-01, MW-02, and MW-04 through MW-09). These wells cover a very small area relative to the areal extent of the plume and in some cases these data represent the only data available for this area. As a result, Figure 4.4 represents the most conservative representation of the 1993 BTEX plume based on available data. BTEX contamination is migrating to the southwest in the direction of ground water flow. During the period through August 1993, the BTEX plume was approximately 1,650 feet long and 750 feet wide at the widest point.

Figure 4.5 is an isopleth map that shows the distribution of total BTEX dissolved in ground water in July 1994. Like Figure 4.4, this figure also includes data collected from monitoring wells in the source area in December 1993/January 1994 (MW-01 through MW-09) to illustrate the BTEX plume for 1994. Comparison of Figures 4.4 and 4.5 suggests that a substantial reduction in the areal extent and concentration of

TABLE 4.4

**FUEL HYDROCARBON COMPOUNDS DETECTED IN GROUND WATER
UST SITE 870 INTRINSIC REMEDIATION EE/CA
HILL AFB, UTAH**

Sample Location	Sample Date	Easting	Northing	Benzene (µg/L)	Toluene (µg/L)	Ethylbenzene (µg/L)	P-Xylene (µg/L)	M-Xylene (µg/L)	M&P-Xylene (µg/L)	O-Xylene (µg/L)	Total Xylenes (µg/L)	Total BTEX (µg/L)	1,3,5-TMB (µg/L)	1,2,4-TMB (µg/L)	1,2,3-TMB (µg/L)
MONITORING WELL SAMPLING LOCATIONS															
EPA-82-A	8/19/93	1546.62	2945.1	<1	<1	<1	<1	<1	NA	<1	<1	<1	<1	<1	<1
EPA-82-A	11/8/93	1546.62	2945.1	<1	BLQ1	<1	<1	<1	NA	<1	<1	BLQ1	1.14	0.965	BLQ1
EPA-82-A	7/94	1546.62	2945.1	<1	<1	<1	<1	<1	NA	<1	<1	<1	<1	<1	<1
EPA-82-B	8/20/93	2062.23	3063.44	<1	4.29	<1	<1	<1	NA	<1	<1	4.29	1.06	1.43	<1
EPA-82-B	11/8/93	2062.23	3063.44	<1	<1	<1	<1	<1	NA	<1	<1	<1	<1	<1	<1
EPA-82-B duplicate	11/8/93	2062.23	3063.44	<1	<1	<1	<1	<1	NA	<1	<1	<1	<1	<1	<1
EPA-82-B duplicate	7/94	2062.23	3063.44	<1	<1	<1	<1	<1	NA	<1	<1	<1	<1	<1	<1
EPA-82-C	8/20/93	1840.49	3035.78	4.92	3.13	26.5	42.8	47.2	NA	2.62	92.62	127.17	238	324	120
EPA-82-C	11/9/93	1840.49	3035.78	<1	6.38	6.81	20.2	6.38	NA	1.82	28.4	41.59	79.7	68.9	64.1
EPA-82-C	7/94	1840.49	3035.78	7.28	9.74	22.7	25.9	18.3	NA	3.18	47.38	87.1	144	143	42.9
EPA-82-D	8/21/93	2167.57	3507.69	95.8	10.4	147	149	383	NA	103	635	888.2	129	183	88.8
EPA-82-D	11/9/93	2167.57	3507.69	174	4.64	30.8	141	293	NA	57.5	491.5	700.94	89.4	119	77.1
EPA-82-D	7/94	2167.57	3507.69	458	9.71	454	272	442	NA	50.7	764.7	1686.41	125	176	60.4
EPA-82-E	8/22/93	1345.36	2845.36	<1	<1	<1	<1	<1	NA	<1	<1	<1	<1	<1	<1
EPA-82-E	11/8/93	1345.36	2845.36	<1	<1	<1	<1	<1	NA	<1	<1	<1	<1	<1	<1
EPA-82-E	7/94	1345.36	2845.36	<1	<1	<1	<1	<1	NA	<1	<1	<1	<1	<1	<1
EPA-82-F	8/21/93	1543.19	2943.57	<1	<1	<1	<1	<1	NA	<1	<1	<1	<1	<1	<1
EPA-82-F	11/9/93	1543.19	2943.57	<1	<1	<1	<1	<1	NA	<1	<1	<1	<1	<1	<1
EPA-82-F	7/94	1543.19	2943.57	ND	ND	<1	<1	<1	NA	ND	<1	<1	ND	<1	ND
EPA-82-F duplicate	7/94	1543.19	2943.57	ND	ND	ND	<1	<1	NA	ND	<1	<1	ND	<1	ND
EPA-82-H	8/21/93	1964.51	2719.71	<1	<1	<1	<1	<1	NA	<1	<1	<1	<1	<1	<1
EPA-82-H	11/8/93	1964.51	2719.71	<1	<1	<1	<1	<1	NA	<1	<1	<1	0.942	BLQ1	BLQ1
EPA-82-H	7/94	1964.51	2719.71	<1	<1	<1	<1	<1	NA	ND	<1	<1	ND	<1	ND
EPA-82-I (a)	11/93	2520.42	3771.26	2740	372	486	784	1370	NA	1140	3294	6892	162	495	240
EPA-82-I	7/94	2520.42	3771.26	5600	5870	955	1620	5130	NA	2300	9050	21475	417	1270	436
EPA-82-J	7/94	NA	NA	4260	3910	816	1370	4220	NA	1760	7350	16336	485	1310	515
MW-01	11/18/91	2475.32	3841.98	305	690	132	NA	NA	NA	NA	2283	3410	NA	NA	NA
MW-01	12/93-1/94	2475.32	3841.98	475	88	183	NA	NA	NA	NA	1160	1906	330	680	NA
MW-02	12/93-1/94	2389.21	3846.24	51	56.3	73.3	NA	NA	NA	NA	776	956.6	350	750	NA
MW-03	08/6/92	2533.09	3882.19	12179	6728	<5	NA	NA	4300	3369	7669	26576	NA	NA	NA
MW-03	10/92	2533.09	3882.19	12.18	6.73	<1	NA	NA	NA	NA	7.67	26.58	NA	NA	NA
MW-03	12/93-1/94	2533.09	3882.19	2320	1300	376	NA	NA	NA	NA	5470	9466	480	1000	NA
MW-04	12/93-1/94	2446.7	3798.05	930	1830	450	NA	NA	NA	NA	5120	8330	550	1500	NA
MW-05	09/30/92	2536.47	3813.49	74	<50	160	NA	NA	NA	NA	900	1134	NA	NA	NA
MW-05 duplicate	09/30/92	2536.47	3813.49	76	<50	150	NA	NA	NA	NA	890	1116	NA	NA	NA
MW-05	12/93-1/94	2536.47	3813.49	416	250	246	NA	NA	NA	NA	2508	3420	450	960	NA
MW-06	9/92	2389.06	3794.35	<25	<25	<25	NA	NA	NA	NA	<25	<25	NA	NA	NA
MW-06	09/04/92	2389.06	3794.35	<25	<25	<25	NA	NA	NA	NA	<25	<25	NA	NA	NA
MW-06	12/93-1/94	2389.06	3794.35	24.5	10.1	18.6	NA	NA	NA	NA	155.9	209.1	650	1500	NA

TABLE 4.4 (Continued)

**FUEL HYDROCARBON COMPOUNDS DETECTED IN GROUND WATER
UST SITE 870 INTRINSIC REMEDIATION EE/CA
HILL AFB, UTAH**

Sample Location	Sample Date	Easting	Northing	Benzene (µg/L)	Toluene (µg/L)	Ethylbenzene (µg/L)	P-Xylene (µg/L)	M-Xylene (µg/L)	M&P-Xylene (µg/L)	O-Xylene (µg/L)	Total Xylenes (µg/L)	Total BTEX (µg/L)	1,3,5-TMB (µg/L)	1,2,4-TMB (µg/L)	1,2,3-TMB (µg/L)
MW-07	9/92	2621.27	3900.79	<5	<5	<5	NA	NA	NA	NA	<5	<5	NA	NA	NA
MW-07 (TWP-3)	09/07/92	2621.27	3900.79	<5	<5	<5	NA	NA	NA	NA	<5	<5	NA	NA	NA
MW-07 duplicate	09/07/92	2621.27	3900.79	<5	<5	<5	NA	NA	NA	NA	<5	<5	NA	NA	NA
MW-07	12/93-1/94	2621.27	3900.79	<1	<1	<1	NA	NA	NA	NA	<1	<1	<1	<1	NA
MW-08	12/93-1/94	2449.7	3893.96	18.6	10.8	29.3	NA	NA	NA	NA	314.4	373.1	140	280	NA
MW-09	12/93-1/94	2529.21	3930.05	72	27	35	NA	NA	NA	NA	558	692	150	650	NA
MW-10	10/92	2354.84	3397.6	1.16	0.57	0.06	NA	NA	NA	NA	0.27	2.06	NA	NA	NA
MW-10 duplicate	10/92	2354.84	3397.6	<5	17	<0.5	NA	NA	NA	NA	110	127	NA	NA	NA
MW-10	10/01/92	2354.84	3397.6	<5	17	<5	NA	NA	NA	NA	110	127	NA	NA	NA
MW-10	8/18/93	2354.84	3397.6	<10	290	443	401	2470	NA	1280	4151	4884	575	828	607
MW-10 duplicate	8/18/93	2354.84	3397.6	<2	340	543	471	2880	NA	1490	4841	5724	713	974	683
MW-10	11/9/93	2354.84	3397.6	7.44	62.9	190	189	1090	NA	505	1784	2044.34	174	297	212
MW-10	7/94			20	54.7	182	190	847	NA	441	1478	1734.7	215	303	197
MW-11	09/30/92	1923.08	3213.91	26	33	21	NA	NA	NA	NA	180	260	NA	NA	NA
MW-11	8/18/93	1923.08	3213.91	336	90.3	139	230	635	NA	204	1069	1634.3	71.8	165	69.3
MW-11	9/93	1923.08	3213.91	26	33	21	NA	NA	NA	NA	180	260	NA	NA	NA
MW-11	11/9/93	1923.08	3213.91	105	46.5	39.9	65	221	NA	86.4	372.4	563.8	30	55.7	28.7
MW-11	7/94			ND	ND	<1	<1	<1	NA	<1	<1	<1	<1	<1	<1
MW-12	10/92	2457.72	3650.34	<5	<5	29	NA	NA	NA	NA	300	329	NA	NA	NA
MW-12	10/01/92	2457.72	3650.34	10	<5	29	NA	NA	NA	NA	300	339	NA	NA	NA
MW-12	7/94			<1	<1	0.9	7.82	9.45	NA	17.3	34.57	35.47	9.89	36.2	13.3
MW-13	12/93-1/94	SDNA	SDNA	2690	1570	589	NA	NA	NA	NA	4280	9129	470	1113	NA
MW-14	12/93-1/94	SDNA	SDNA	941	2800	505	NA	NA	NA	NA	5510	9756	650	1400	NA
GEOPROBE SAMPLING LOCATIONS															
71-8 CPT (depth 1)		2547.88	3772.45	<1	BLQ1	<1	<1	<1	NA	2.2	2.2	2.2	<1	<1	<1
71-17 CPT (depth 1)	8/3/93	1528.38	3493.12	<1	<1	<1	<1	<1	NA	<1	<1	<1	<1	<1	<1
71-17 CPT (depth 2)	8/3/93	1528.38	3493.12	<1	<1	<1	<1	<1	NA	<1	<1	<1	<1	<1	<1
71-18 CPT (depth 1)	8/3/93	1885.05	3457.77	<1	1.27	<1	<1	BLQ1	NA	<1	BLQ1	1.27	<1	1.1	1.08
71-18 CPT (depth 2)	8/3/93	1885.05	3457.77	<1	<1	<1	<1	<1	NA	<1	<1	<1	<1	<1	<1
71-19 CPT (depth 1)	8/2/93	1948.46	3215.91	51.4	BLQ1	461	869	2730	NA	984	4583	5095.4	295	735	330
71-19 CPT (depth 1) duplicate	8/2/93	1948.46	3215.91	NA	NA	NA	NA	NA	NA	NA	NA	NA	NA	NA	NA
71-23 CPT (depth 1)	8/5/93	2526.12	2835.21	<1	BLQ1	<1	<1	<1	NA	<1	<1	<1	<1	<1	<1
71-29 CPT (depth 1)	8/2/93	1400.23	2863.23	<1	<1	<1	<1	<1	NA	<1	<1	<1	<1	<1	<1
71-29 CPT (depth 2)	8/2/93	1400.23	2863.23	<1	<1	<1	<1	<1	NA	<1	<1	<1	<1	<1	<1
71-31 CPT (depth 1)	8/3/93	1418.19	3205.92	<1	<1	<1	<1	<1	NA	<1	<1	<1	<1	<1	<1
71-31 CPT (depth 1) duplicate	8/3/93	1418.19	3205.92	<1	<1	<1	<1	<1	NA	<1	<1	<1	<1	<1	<1
71-31 CPT (depth 2)	8/3/93	1418.19	3205.92	<1	<1	<1	<1	<1	NA	<1	<1	<1	<1	<1	<1

TABLE 4.4 (Continued)

FUEL HYDROCARBON COMPOUNDS DETECTED IN GROUND WATER
UST SITE 870 INTRINSIC REMEDIATION EE/CA
HILL AFB, UTAH

Sample Location	Sample Date	Easting	Northing	Benzene (µg/L)	Toluene (µg/L)	Ethylbenzene (µg/L)	P-Xylene (µg/L)	M-Xylene (µg/L)	M&P-Xylene (µg/L)	O-Xylene (µg/L)	Total Xylenes (µg/L)	Total BTEX (µg/L)	1,3,5-TMB (µg/L)	1,2,4-TMB (µg/L)	1,2,3-TMB (µg/L)
71-39 CPT (depth 1)	8/5/93	2758.65	4145.21	<1	<1	<1	<1	<1	NA	<1	<1	<1	<1	<1	<1
71-39 CPT (depth 2)	8/5/93	2758.65	4145.21	<1	<1	<1	<1	<1	NA	<1	<1	<1	<1	<1	<1
71-39 CPT (depth 2)duplicate	8/5/93	2758.65	4145.21	NA	NA	NA	NA	NA	NA	NA	NA	NA	NA	NA	NA
EPA-82-K	7/94	1458.62	2656.22	<1	<1	<1	<1	<1	NA	<1	<1	<1	ND	<1	ND
EPA-82-L1	7/94	-8055.75	2834.32	6	18.1	103	379	572	NA	604	1555	1682.1	396	433	223
EPA-82-L2	7/94	-8055.75	2834.32	4.01	18.8	9.72	23.8	49.2	NA	35.8	108.8	141.33	22	28.6	15.2
EPA-82-L3	7/94	-8055.75	2834.32	1.44	7.19	4	8.53	20.2	NA	12.9	41.63	54.26	7.43	13.8	8.88
EPA-82-M	7/94	1700.5	2698.09	<1	3	1.58	2.89	7.59	NA	4.95	15.43	20.01	2.33	4.56	3.06
EPA-82-M duplicate	7/94	1700.5	2698.09	<1	3.1	1.5	2.77	7.63	NA	5.1	15.5	20.1	2.23	4.33	2.93
EPA-82-N	7/94	1425.23	2738.09	<1	<1	<1	<1	<1	NA	<1	<1	<1	ND	<1	<1
EPA-82-O	7/94	1594.5	2688.82	<1	<1	<1	<1	<1	NA	<1	<1	<1	ND	<1	<1
EPA-82-P	7/94	1776.37	2865.35	<1	<1	3.5	11.5	18.8	NA	5.99	36.29	39.79	77.7	159	57.9
CONE PENETROMETER SAMPLING LOCATIONS															
CPT-07	08/07/92	2547.88	3772.45	<500	<500	1800	NA	NA	4600	1900	6500	8300	NA	NA	NA
CPT-07	09/30/92	2547.88	3772.45	680	34(EST)	1400	NA	NA	NA	NA	5700	7814	NA	NA	NA
CPT-10	10/19/92	2602.28	3772.04	<5	11	16	NA	NA	NA	NA	160	187	NA	NA	NA
CPT-14	12/18/92	2182.6	3507.6	<250,000	<250,000	1400000	NA	NA	NA	NA	13000000	14400000	NA	NA	NA
CPT-40	11/24/92	2758.65	4145.21	<1	<1	<1	NA	NA	<1	<1	<1	<1	NA	NA	NA
CPT-42	11/24/93	3067.32	3238.57	<1	<1	<1	NA	NA	<1	<1	<1	<1	NA	NA	NA
CPT-42	11/30/92	3067.32	3238.57	<1	<1	<1	NA	NA	<1	<1	<1	<1	NA	NA	NA
CPT-43	11/24/93	2683.44	3014.06	<1	<1	<1	NA	NA	<1	<1	<1	<1	NA	NA	NA
CPT-43	11/30/92	2683.44	3014.06	<1	<1	<1	NA	NA	<1	<1	<1	<1	NA	NA	NA
TP-01	08/5/92	SDNA	SDNA	741	2273	<5	NA	NA	540	487	1027	4041	NA	NA	NA
TP-02	08/5/92	SDNA	SDNA	5203	7578	740	NA	NA	1903	2274	4177	17698	NA	NA	NA
TP-03	08/10/92	SDNA	SDNA	2701	3112	322	NA	NA	801	854	1655	7790	NA	NA	NA
TP-07	08/5/92	2547.88	3772.45	26092	21919	753	NA	NA	1459	2447	3906	52670	NA	NA	NA
TP-09	08/6/92	SDNA	SDNA	992	2128	173	NA	NA	211	90	301	3594	NA	NA	NA
TP-10	08/6/92	2602.28	3772.04	1928	3214	<5	NA	NA	1854	1976	3830	8972	NA	NA	NA
TP-12	08/7/92	2354.84	3397.6	1163	565	62	NA	NA	215	50	265	2055	NA	NA	NA
TP-13	08/7/92	2062.91	3060.14	<5	69	<5	NA	NA	62	<5	62	131	NA	NA	NA
TP-14	08/7/92	2182.6	3507.6	1440	392	338	NA	NA	930	448	1378	3548	NA	NA	NA
TP-17	08/8/92	1528.38	3493.12	<5	<5	14	NA	NA	57	<5	57	71	NA	NA	NA
TP-19	08/8/92	1948.46	3215.91	646	<5	36	NA	NA	149	<5	149	831	NA	NA	NA
TP-20	08/8/92	1848.28	3037.59	124	2699	<5	NA	NA	<5	504	504	3327	NA	NA	NA
TP-21	08/8/92	2349.56	3244.25	<5	<5	<5	NA	NA	57	<5	57	57	NA	NA	NA
TP-22	08/9/92	SDNA	SDNA	56	90	22	NA	NA	68	36	104	272	NA	NA	NA
TP-36	08/13/92	2670.91	3231.11	<5	<5	<5	NA	NA	52	<5	52	52	NA	NA	NA
TP-37	08/13/92	1970.3	2978.15	789	930	<5	NA	NA	2410	1769	4179	5898	NA	NA	NA
TWP-01	08/12/92	SDNA	SDNA	520	1271	85	NA	NA	141	32	173	2049	NA	NA	NA
STORM SEWER SAMPLING LOCATIONS															
STORM-2	8/93	1430.1	2443.98	<1	<1	<1	<1	<1	NA	<1	<1	<1	<1	<1	<1
STORM-3	8/93	1445.12	2511.52	<1	<1	<1	<1	<1	NA	<1	<1	<1	<1	<1	<1

TABLE 4.4 (Concluded)

FUEL HYDROCARBON COMPOUNDS DETECTED IN GROUND WATER
UST SITE 870 INTRINSIC REMEDATION EE/CA
HILL AFB, UTAH

Sample Location	Sample Date	Easting	Northing	Benzene (µg/L)	Toluene (µg/L)	Ethylbenzene (µg/L)	P-Xylene (µg/L)	M-Xylene (µg/L)	M&P-Xylene (µg/L)	O-Xylene (µg/L)	Total Xylenes (µg/L)	Total BTEX (µg/L)	1,3,5-TMB (µg/L)	1,2,4-TMB (µg/L)	1,2,3-TMB (µg/L)
MISCELLANEOUS SAMPLING LOCATIONS															
870-WS-1/32'	11/23/92	SDNA	SDNA	17.4	1.8	BLQ1	NA	NA	4.9	1.3	6.2	25.4	NA	NA	NA
870-WS-1/42'	11/23/92	SDNA	SDNA	30.5	113	56.4	NA	NA	369	103	472	671.9	NA	NA	NA
870-WS-1/52'	11/24/92	SDNA	SDNA	27	59.3	21.6	NA	NA	107	36.4	143.4	251.3	NA	NA	NA
870-WS-2/49 duplicate	11/24/92	SDNA	SDNA	6.5	7.8	1.7	NA	NA	12.2	3.4	15.6	31.6	NA	NA	NA
870-WS-2/49'	11/24/92	SDNA	SDNA	8.4	13.8	4.5	NA	NA	30.2	9.4	39.6	66.3	NA	NA	NA
870-WS-2/59'	11/24/92	SDNA	SDNA	24	68	50.7	NA	NA	294	93.7	387.7	530.4	NA	NA	NA
870-WS-2/69'	11/24/92	SDNA	SDNA	43.5	71.7	38.2	NA	NA	258	63.6	321.6	475	NA	NA	NA
GWS-01	08/14/92	SDNA	SDNA	195	946	72	NA	NA	62	27	89	1302	NA	NA	NA
SGS-01	08/05/92	SDNA	SDNA	161	12645	46	NA	NA	<5	295	295	13147	NA	NA	NA
SGS-1	08/07/92	SDNA	SDNA	7.7	<5	5.5	NA	NA	8.8	19	27.8	41	NA	NA	NA

See Appendix C for analytical methods

(a)=Headspace data

BLQ1=Detected below Limit of Quantification of 1 µg/L

BLQ2=Detected below Limit of Quantification of 4 µg/L

BLQ3=Detected below Limit of Quantification of 2 µg/L

BLQ4=Detected below Limit of Quantification of 10 µg/L

NA = Sample not analyzed for this parameter

EST = Estimated value reported by lab

SDNA=Surveyor's data not available

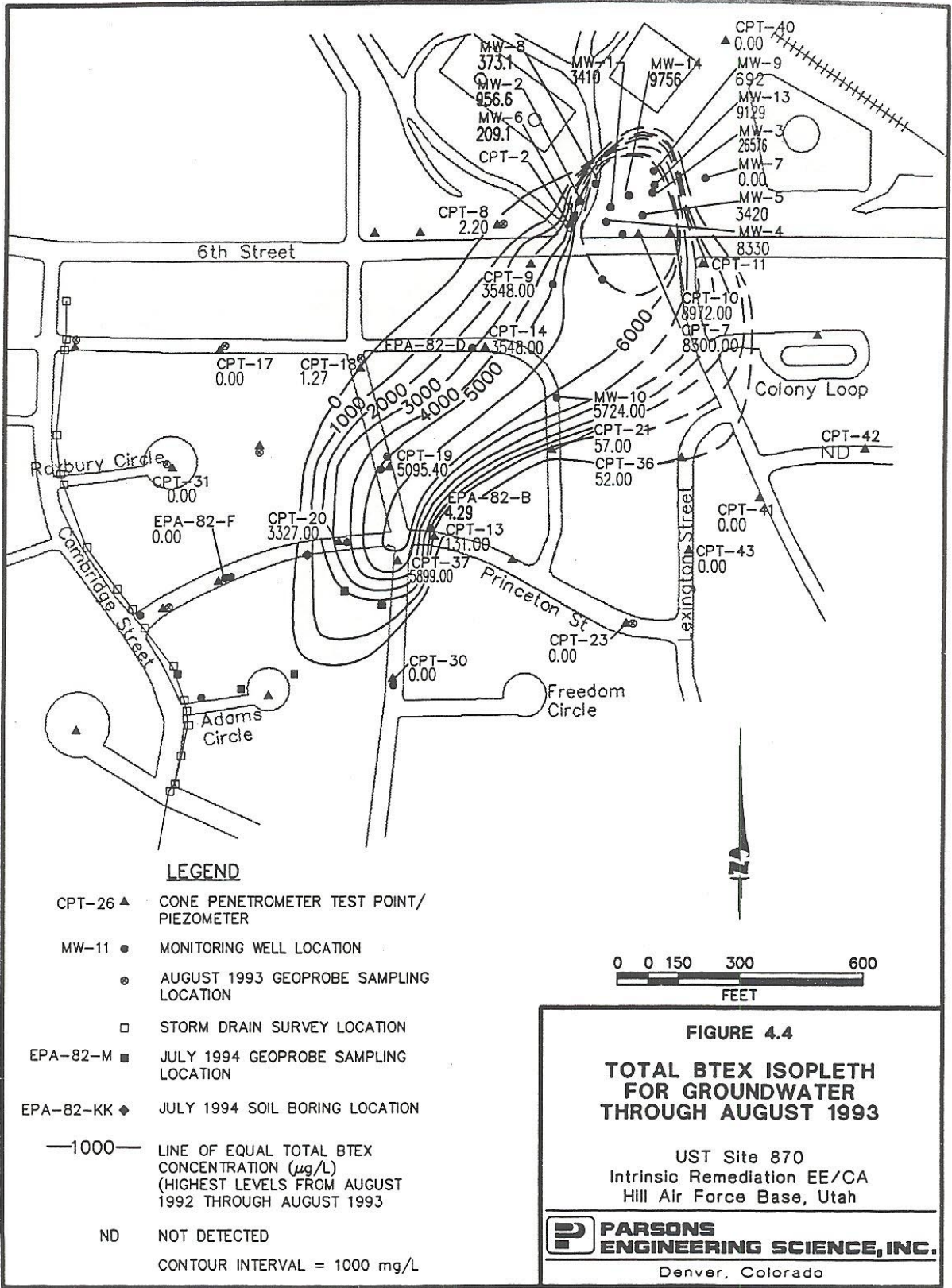

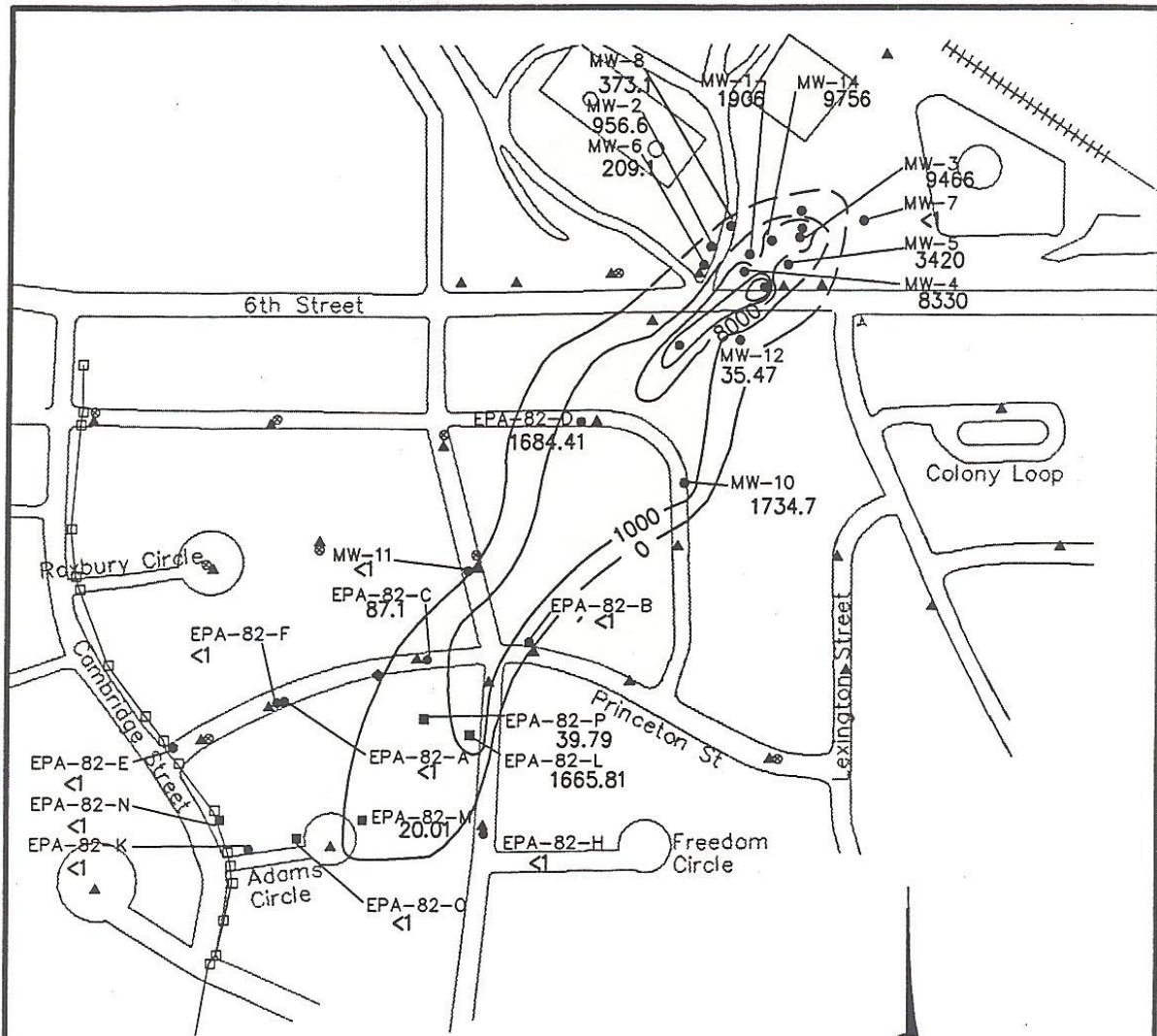

LEGEND

- CPT-26 ▲ CONE PENETROMETER TEST POINT/
PIEZOMETER
- MW-11 ● MONITORING WELL LOCATION
- ⊙ AUGUST 1993 GEOPROBE SAMPLING
LOCATION
- STORM DRAIN SURVEY LOCATION
- EPA-82-M ■ JULY 1994 GEOPROBE SAMPLING
LOCATION
- EPA-82-KK ◆ JULY 1994 SOIL BORING LOCATION
- 1000 — LINE OF EQUAL BTEX
CONCENTRATION (ug/L)
(DASHED WHERE INFERRED)

CONTOUR INTERVAL = VARIABLE



FIGURE 4.5

**TOTAL BTEX ISOPLETH
FOR GROUNDWATER
JULY 1994**

UST Site 870
Intrinsic Remediation EE/CA
Hill Air Force Base, Utah

**PARSONS
ENGINEERING SCIENCE, INC.**

Denver, Colorado

the BTEX plume occurred between September 1992/August 1993 and July 1994. With the exception of total BTEX concentrations in some of the monitoring wells located in the area containing mobile LNAPL (wells MW-05, MW-06, EPA-82-I, EPA-82-D), dissolved-phase total BTEX concentrations were seen to decline over this period. The increased concentrations in these wells could be the result of a fresh spill in the source area. Figure 4.4 shows that through August 1993, the majority of the dissolved-phase BTEX plume had concentrations in excess of 5,000 micrograms per liter ($\mu\text{g/L}$) whereas Figure 4.5 shows that in July 1994, the majority of the dissolved-phase BTEX plume had concentrations below 2,000 $\mu\text{g/L}$. Because Figure 4.4 was prepared with the highest BTEX concentrations observed between August 1992 and August 1993, comparison of these two figures may suggest rates of intrinsic remediation that are somewhat high. Available geochemical data suggest that this reduction in the areal extent and concentration of the total BTEX plume was primarily the result of biodegradation, as discussed in the following sections.

4.3.2 Inorganic Chemistry and Geochemical Indicators of Biodegradation

Microorganisms obtain energy for cell production and maintenance by catalyzing the transfer of electrons from electron donors to electron acceptors. This results in the oxidation of the electron donor and the reduction of the electron acceptor. Electron donors at UST Site 870 are natural organic carbon and fuel hydrocarbon compounds. Fuel hydrocarbons are completely degraded or detoxified if they are utilized as the primary electron donor for microbial metabolism (Bouwer, 1992). Electron acceptors are elements or compounds that occur in relatively oxidized states and include oxygen, nitrate, ferrous iron, sulfate, and carbon dioxide. Microorganisms preferentially utilize electron acceptors while metabolizing fuel hydrocarbon (Bouwer, 1992). Dissolved oxygen is utilized first as the prime electron acceptor. After the DO is consumed, anaerobic microorganisms use electron acceptors in the following order of preference: nitrate, ferrous iron, sulfate, and finally carbon dioxide. Anaerobic destruction of the BTEX compounds is associated with the accumulation of fatty acids, production of methane, solubilization of iron, and reduction of nitrate and sulfate (Cozzarelli *et al.*, 1990; Wilson *et al.*, 1990).

4.3.2.1 Dissolved Oxygen

DO concentrations were measured at Geoprobe[®] locations and monitoring points/wells in August 1993, November 1993, December 1993/January 1994, and July 1994. Table 4.5 summarizes DO concentrations. Figure 4.6 is an isopleth map showing the distribution of DO in

TABLE 4.5

**GROUND WATER GEOCHEMICAL DATA
UST SITE 870 INTRINSIC REMEDIATION EE/CA
HILL AFB, UTAH**

Sample Location	Sample Date	Water Temp. (°C)	Dissolved Oxygen (mg/L)	Redox Potential (mV)	Total Alkalinity (mg/L)	Conductivity (µS/cm)	pH	Chloride (mg/L)	Sulfate (mg/L)	Ferrous Iron (mg/L)	Ammonia (mg/L)	Nitrate (mg/L)	Nitrite (mg/L)	NO ₂ +NO ₃ Nitrogen (mg/L)	Methane (mg/L)	TOC (mg/L)
MONITORING WELL SAMPLING LOCATIONS																
EPA-82-A	8/19/93	16.5	0.4	170	576	1677	7.2	170	66.4	<0.05	<0.05	NA	NA	0.14	0.001	4.2
EPA-82-A	11/8/93	14.8	0.3	NA	NA	NA	7.4	159	60.5	0.17	NA	NA	NA	0.08	0.001	2.2
EPA-82-A	7/7/94	16.3	<0.5	240	530	1622	7.2	156.0	58.6	<0.05	NA	NA	NA	<0.05	0.001	2.8
EPA-82-B	8/20/93	16.9	1	213	450	1421	6.9	163	76.9	<0.05	<0.05	NA	NA	0.25	0.001	2.1
EPA-82-B	11/8/93	12.9	1.2	NA	NA	NA	7.5	144	72.2	0.11	NA	NA	NA	0.37	<0.001	3.1
EPA-82-B	7/7/94	19.1	<0.5	125	428	1406	7.2	145.0	74.2	0.1	NA	NA	NA	0.15	0.001	2.2
EPA-82-C	8/20/93	15.5	0.5	-125	745	1828	6.9	164	49.9	2.1	<0.05	NA	NA	0.13	0.002	9.4
EPA-82-C duplicate	8/20/93	NA	NA	NA	NA	NA	NA	161	NA	NA	NA	NA	NA	NA	NA	9.5
EPA-82-C	11/9/93	14.2	0.4	NA	NA	NA	6.3	109	17.2	0.84	NA	NA	NA	0.08	0.002	6
EPA-82-D	8/21/93	15.9	1.3	40	959	2520	7.3	198	193 (EST)	0.4	0.07	NA	NA	0.53	<0.001	8.1
EPA-82-D duplicate	8/21/93	NA	NA	NA	NA	NA	NA	NA	NA	NA	0.05	NA	NA	0.53	NA	NA
EPA-82-D	11/9/93	14.1	0.8	NA	NA	NA	7.2	151	116	1.7	NA	NA	NA	0.13	<0.001	5.2
EPA-82-D duplicate	11/9/93	NA	NA	NA	NA	NA	NA	NA	NA	NA	NA	NA	NA	NA	NA	5.3
EPA-82-D	7/7/94	17	<0.5	-138	657	1905	7.3	221.0	<0.5	7.4	NA	NA	NA	<0.05	0.002	10.3
EPA-82-E	8/22/93	22.8	5.6	192	349	1042	7.3	77.1	39.6	<0.05	<0.05	NA	NA	4.4	<0.001	1.7
EPA-82-E duplicate	8/22/93	NA	NA	NA	NA	NA	NA	78.3	39.8	NA	NA	NA	NA	NA	NA	NA
EPA-82-E	11/8/93	16.5	2.7	NA	NA	NA	7.4	76.4	65.8	0.02	NA	NA	NA	5.61	<0.001	1.9
EPA-82-E	7/7/94	22.6	3.7	106	357	2020	7.1	354.0	37.0	<0.05	NA	NA	NA	4.39	0.001	1.7
EPA-82-F	8/21/93	22.6	1.1	243	550	1275	7.5	68.5	63.9	<0.05	<0.05	NA	NA	7.41	0.019	2.2
EPA-82-F duplicate	8/21/93	NA	NA	NA	NA	NA	NA	71.8	67.9	NA	<0.05	NA	NA	7.46	NA	NA
EPA-82-F	11/9/93	16.8	1.1	NA	NA	NA	7.6	60.2	55.5	0.04	NA	NA	NA	5.07	0.006	1.9
EPA-82-F duplicate	11/9/93	NA	NA	NA	NA	NA	NA	60.7	55	NA	NA	NA	NA	5.06	NA	NA
EPA-82-F	7/7/94	21.5	<0.5	-70	490	1172	7.3	46.9	52.3	0.5	NA	NA	NA	1.67	0.577	4.4
EPA-82-H	8/22/93	18	6.3	190	485	1400	7.1	136	59.7	<0.05	<0.05	NA	NA	2.12	<0.001	2.2
EPA-82-H	11/8/93	15.7	5.4	NA	NA	NA	7.4	104	55.7	0.19	NA	NA	NA	2.01	<0.001	1.6
EPA-82-H	7/7/94	14.7	5.9	272	492	1384	7.2	129.0	62.3	<0.05	NA	NA	NA	1.51	0.001	2.6
EPA-82-I	11/93	NA	NA	NA	NA	NA	NA	NA	NA	NA	NA	NA	NA	NA	0.68	NA
EPA-82-I	7/8/94	16.3	0.7	-90	491	1124	7.1	76.7	<0.5	10.3	NA	NA	NA	<0.05	1.886	67.1
EPA-82-J	7/12/94	14.7	2.2	NA	430	1280	7.0	158.0	<0.5	1.3	NA	NA	NA	0.05	0.052	46
MW-01	12/93-1/94	NA	0.3	NA	NA	NA	NA	NA	2	10.8	NA	<0.05	<0.01	<0.05	0.041	NA
MW-01 duplicate	12/93-1/94	NA	NA	NA	NA	NA	NA	NA	NA	NA	NA	NA	NA	NA	0.042	NA
MW-02	12/93-1/94	NA	0.4	NA	NA	NA	NA	NA	40	50.5	NA	0.25	<0.01	0.25	<0.0003	NA
MW-03	12/93-1/94	NA	1.5	NA	NA	NA	NA	NA	<2	8.2	NA	<0.05	0.025	<0.05	0.459	NA
MW-04	12/93-1/94	NA	1.4	NA	NA	NA	NA	NA	<2	13.6	NA	1.68	0.637	2.32	0.012	NA
MW-05	12/93-1/94	NA	0.7	NA	NA	NA	NA	NA	<2	6.41	NA	<0.05	<0.01	<0.05	2.04	NA
MW-06	12/93-1/94	NA	0.8	NA	NA	NA	NA	NA	21	10.3	NA	0.04	0.031	0.07	0.002	NA
MW-07	12/93-1/94	NA	4.6	NA	NA	NA	NA	NA	26	1.36	NA	11.78	0.021	11.8	<0.001	NA
MW-08	12/93-1/94	NA	0.2	NA	NA	NA	NA	NA	11	5.22	NA	0.28	<0.01	0.28	0.006	NA
MW-09	12/93-1/94	NA	NA	NA	NA	NA	NA	NA	22	2.07	NA	0.4	0.577	0.4	0.006	NA
MW-10	8/18/93	15.4	0.6	125	518	1162	7.1	44.7	63.2	<0.05	<0.05	NA	NA	9.16	0.004	27.8
MW-10	11/9/93	15	1.5	NA	NA	NA	7.4	33.9	53.1	0.22	NA	NA	NA	17.4	0.001	5.3
MW-10 duplicate	11/9/93	NA	NA	NA	NA	NA	NA	NA	NA	NA	NA	NA	NA	17.1	NA	NA
MW-10	7/7/94	16.6	<0.5	-190	502	1076	7.3	47.1	19.5	0.8	NA	NA	NA	2.67	0.006	9.3

TABLE 4.5 (Concluded)

**GROUND WATER GEOCHEMICAL DATA
UST SITE 870 INTRINSIC REMEDIATION EE/CA
HILL AFB, UTAH**

Sample Location	Sample Date	Water Temp. (°C)	Dissolved Oxygen (mg/L)	Redox Potential (mV)	Total Alkalinity (mg/L)	Conductivity (µS/cm)	pH	Chloride (mg/L)	Sulfate (mg/L)	Ferrous Iron (mg/L)	Ammonia (mg/L)	Nitrate (mg/L)	Nitrite (mg/L)	NO ₂ +NO ₃ Nitrogen (mg/L)	Methane (mg/L)	TOC (mg/L)
MONITORING WELL SAMPLING LOCATIONS (Continued)																
MW-11	8/18/93	14.8	0.1	66	543	1209	7	48.7	97.6	0.2	0.25	NA	NA	0.36	0.117	8
MW-11 duplicate	8/18/93	NA	NA	NA	NA	NA	NA	NA	98	0.2	NA	NA	NA	NA	0.095	8
MW-11	11/9/93	14.7	0.1	NA	NA	NA	7.4	29.5	94.1	0.05	NA	NA	NA	0.17	0.022	4
MW-11 duplicate	11/9/93	NA	NA	NA	NA	NA	NA	NA	NA	NA	NA	NA	NA	NA	NA	3.8
MW-11	7/8/94	15.8	<0.5	140	504	1125	7.0	27.0	99.0	<0.05	NA	NA	NA	<0.05	0.005	3.5
MW-12	7/8/94	15.3	<0.5	171	450	959	7.1	13.2	29.2	<0.05	NA	NA	NA	7.73	0.005	2.4
MW-13	12/93-1/94	NA	NA	NA	NA	NA	NA	NA	3	10.3	NA	0.06	0.037	0.1	0.498	NA
MW-13 duplicate	12/93-1/94	NA	NA	NA	NA	NA	NA	NA	NA	NA	NA	NA	NA	NA	0.483	NA
MW-14	12/93-1/94	NA	NA	NA	NA	NA	NA	NA	27.0	5.96	NA	1.72	0.187	1.91	0.023	NA
MW-14 duplicate	12/93-1/94	NA	NA	NA	NA	NA	NA	NA	NA	NA	NA	NA	NA	NA	0.023	NA
GEOPROBE SAMPLING LOCATIONS																
71-17 CPT (depth 1)	8/3/93	24	5.8	135	384	1127	7.3	71.5	74.4	<0.05	0.3	NA	NA	3.78	0.0044	3.6
71-17 CPT (depth 1) duplicate	8/3/93	22.2	5.2	NA	NA	NA	NA	NA	NA	NA	NA	NA	NA	NA	NA	NA
71-17 CPT (depth 2)	8/3/93	22	1.1	-10	451	1495	7.3	189	8.05	0.2	0.21	NA	NA	2.13	0.0064	2.1
71-18 CPT (depth 1)	8/3/93	NA	NA	NA	NA	NA	NA	109	34.8	0.2	0.26	NA	NA	1.85	0.0007	NA
71-18 CPT (depth 1) duplicate	8/3/93	NA	NA	NA	NA	NA	NA	108	34.6	NA	0.17	NA	NA	1.91	NA	NA
71-18 CPT (depth 2)	8/3/93	20	1.1	180	440	1151	7.4	90.2	39.4	<0.05	0.11	NA	NA	3.89	0.0017	1.6
71-18 CPT (depth 2) duplicate	8/3/93	NA	NA	NA	NA	NA	NA	90.3	39.8	0.6	NA	NA	NA	NA	NA	NA
71-19 CPT (depth 1)	8/2/93	25	0.5	-63	612	1196	7.1	50.5	5.68	0.6	0.99	NA	NA	0.19	0.0564	5.4
71-19 CPT (depth 1) duplicate	8/2/93	NA	NA	NA	NA	NA	NA	NA	NA	NA	NA	NA	NA	NA	0.0552	NA
71-23 CPT (depth 1)	8/5/93	19	NA	274	632	1451	7.4	118	51.2	0.1	0.14	NA	NA	2.7	0.0001	2.1
71-23 CPT (depth 2)	8/5/93	18.7	4.3	NA	NA	NA	NA	NA	NA	NA	NA	NA	NA	NA	NA	NA
71-29 CPT (depth 1)	8/2/93	25	2	99	457	1604	7.1	NA	NA	<0.05	0.3	NA	NA	1.4	0.0007	2.7
71-29 CPT (depth 2)	8/2/93	22.5	NA	-137	452	1256	7.4	107	52.6	<0.05	<0.05	NA	NA	3.9	0.0541	1.9
71-29 CPT (depth 2) duplicate	8/2/93	NA	NA	NA	NA	NA	NA	NA	NA	NA	NA	NA	NA	NA	NA	2
71-29 CPT (depth 7)	8/2/93	NA	NA	NA	NA	NA	NA	NA	NA	NA	0.19	NA	NA	1.59	NA	NA
71-31 CPT (depth 1)	8/3/93	25	NA	162	394	1099	7.3	93.2	46.9	0.1	<0.05	NA	NA	3.66	0.0032	2.7
71-31 CPT (depth 1) duplicate	8/3/93	NA	4.5	NA	NA	NA	NA	NA	NA	NA	NA	NA	NA	NA	NA	NA
71-31 CPT (depth 2)	8/3/93	23	4.2	152	378	1082	7.3	91.7	47.4	<0.05	<0.05	NA	NA	4.69	0.0111	1.9
71-38 CPT (depth 1)	8/3/93	NA	NA	NA	NA	NA	NA	170	58	NA	<0.05	NA	NA	3.77	0.035	3.3
71-38 CPT (depth 1) duplicate	8/3/93	NA	NA	NA	NA	NA	NA	NA	NA	NA	NA	NA	NA	NA	NA	3.3
71-38 CPT (depth 2)	8/3/93	18	1.8	56	646	1628	7.3	NA	NA	<0.05	NA	NA	NA	NA	NA	NA
71-39 CPT (depth 1)	8/5/93	21	NA	179	592	1525	7.7	161	56.8	0.05	<0.05	NA	NA	4.17	0.0141	2.8
71-39 CPT (depth 1) duplicate	8/5/93	NA	NA	NA	NA	NA	NA	NA	NA	NA	NA	NA	NA	NA	0.0219	2.9
71-39 CPT (depth 2)	8/5/93	24	NA	207	451	1321	8.3	114	31.5	<0.05	<0.05	NA	NA	4.13	NA	NA
71-39 CPT (depth 2) duplicate	8/5/93	NA	NA	NA	NA	NA	NA	116	NA	NA	NA	NA	NA	NA	NA	NA
71-8 CPT (depth 1)	8/93	NA	NA	NA	NA	NA	NA	NA	NA	NA	NA	NA	NA	NA	0.0212	8
EPA-82-L1	7/9/94	17.2	<0.5	-106	730	1662	7.1	112.0	<0.5	2.4	NA	NA	NA	<0.05	0.018	5.6
EPA-82-L1 duplicate	7/9/94	NA	NA	NA	NA	NA	NA	NA	NA	NA	NA	NA	NA	<0.05	NA	4.4
EPA-82-L2	7/9/94	17.6	<0.5	-30	732	1584	7.1	86.4	36.0	0.1	NA	NA	NA	0.05	0.003	3.1
EPA-82-L3	7/9/94	18.6	<0.5	-10	706	1530	7.3	90.1	61.0	0.1	NA	NA	NA	0.3	0.002	2.4
EPA-82-M	7/9/94	18.8	1.2	208	666	1450	7.3	73.8	35.4	<0.05	NA	NA	NA	1.8	0.121	2.9
EPA-82-N	7/11/94	20.6	2.0	250	256	1278	7.4	120.0	42.6	<0.05	NA	NA	NA	1.14	0.004	3.7
EPA-82-O	7/11/94	17.7	0.5	120	566	1403	7.4	78.4	37.1	<0.05	NA	NA	NA	1.63	0.001	2.8
EPA-82-K	7/11/94	20.9	2.0	197	498	1171	7.8	60.0	59.8	<0.05	NA	NA	NA	4.44	0.003	2.4
EPA-82-P	7/11/94	NA	<0.5	NA	792	1671	7.4	148.0	<0.5	0.2	NA	NA	NA	<0.05	0.004	6.8

See Appendix C for analytical methods
EST=Estimated value reported by lab
NA=Sample not analyzed for this parameter

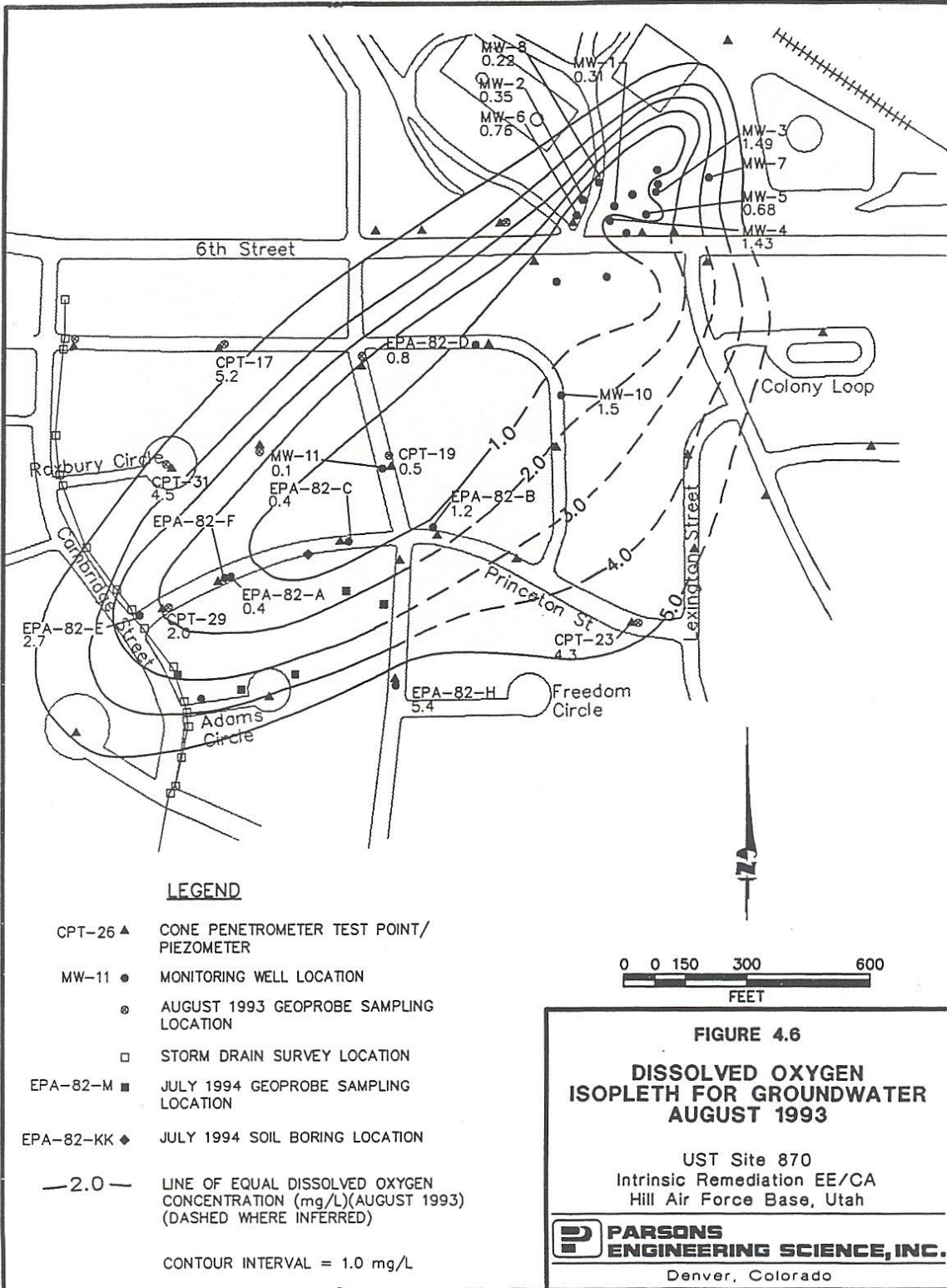

ground water in August 1993. This figure includes data collected from monitoring wells in the source area north of Sixth Street in December 1993/January 1994. These wells cover a small area and these data represent the only data available for this area. Figure 4.7 is an isopleth map showing the distribution of DO in ground water in July 1994. This figure also includes data collected from monitoring wells in the source area in December 1993/January 1994. Comparison of Figures 4.4 and 4.6 and Figures 4.5 and 4.7 shows graphically that areas with elevated total BTEX concentrations have depleted DO concentrations. This is a strong indication that aerobic biodegradation of the BTEX compounds is occurring at the site.

In the absence of microbial cell production, the oxidation (biodegradation) of benzene to carbon dioxide and water is given by:

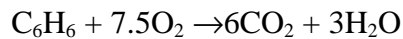

Therefore, 7.5 moles of oxygen are required to mineralize 1 mole of benzene. On a mass basis, the ratio of oxygen to benzene is given by:

Molecular weights:	Benzene	$6(12) + 6(1) = 78$ gm/mole
	Oxygen	$7.5(32) = 240$ gm/mole

$$\text{Mass Ratio of Oxygen to Benzene} = 240/78 = 3.08:1$$

In the absence of microbial cell production, 3.08 mg of oxygen are required to completely mineralize 1 mg of benzene. Similar calculations can be completed for toluene (3.13 mg oxygen to 1 mg toluene), ethylbenzene (3.17 mg oxygen to 1 mg ethylbenzene), and the xylenes (3.17 mg oxygen to 1 mg xylene). The average mass ratio of oxygen consumed to total BTEX degraded is thus 3.14:1. This means that approximately 0.32 mg of BTEX is mineralized to carbon dioxide and water for every 1.0 mg of DO consumed. With a background DO concentration of approximately 6 mg/L, the shallow ground water at this site has the capacity to assimilate 1.9 mg/L (1,900 µg/L) of total BTEX. This is a very conservative estimate of the assimilative capacity of DO because microbial cell mass production was not taken into account by the stoichiometry shown above.

When cell mass production is accounted for, the mineralization of benzene to carbon dioxide and water is given by:

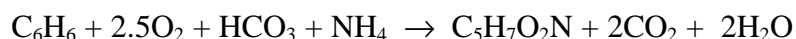

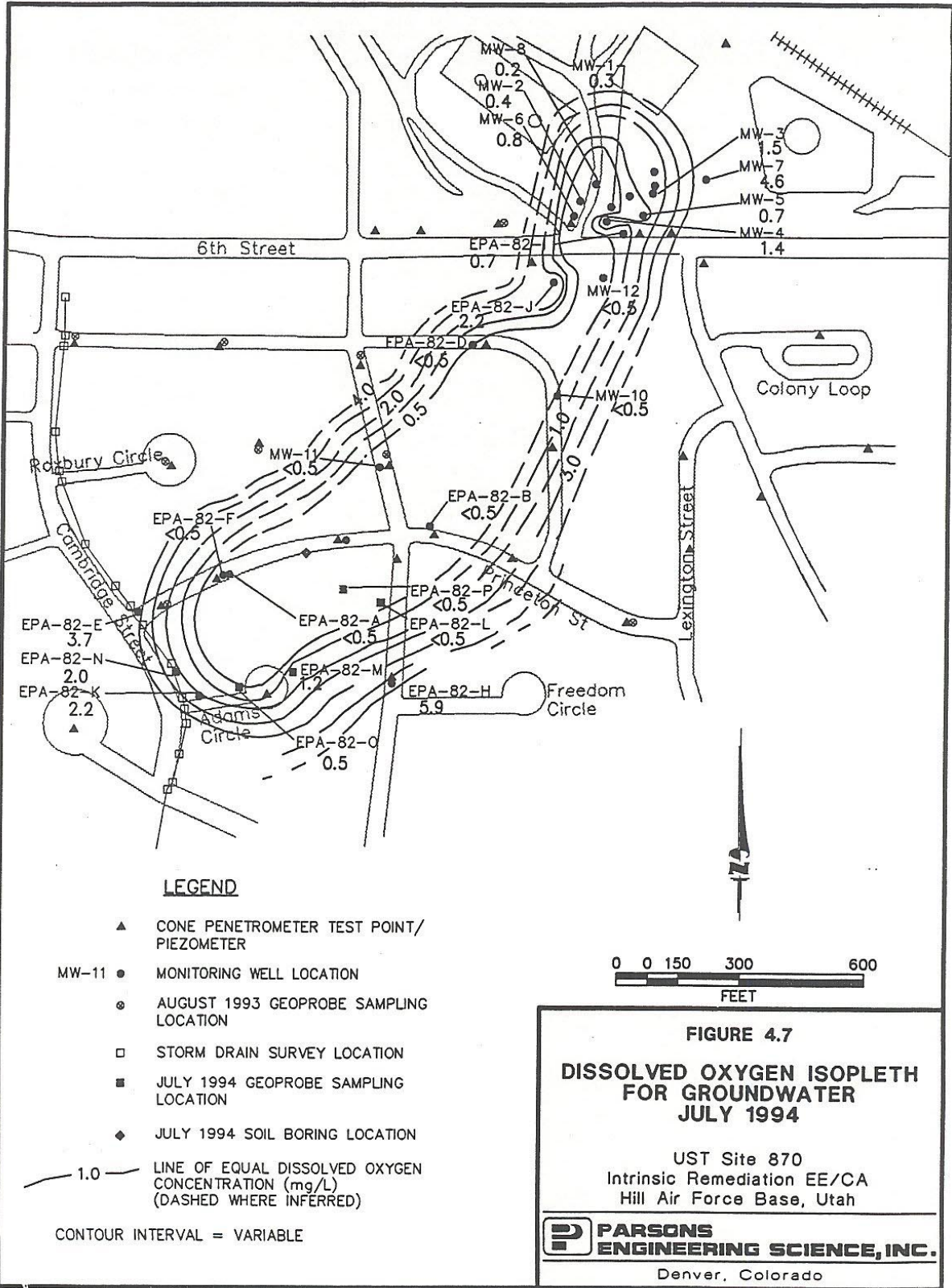

From this it can be seen that only 2.5 moles of DO are required to mineralize 1 mole of benzene when cell mass production is taken into account. On a mass basis, the ratio of DO to benzene is given by:

Molecular weights:	Benzene	$12(6) + 1(6) = 78$ gm/mole
	Oxygen	$2.5(32) = 80$ gm/mole

$$\text{Mass Ratio of Oxygen to Benzene} = 80/78 = 1.03:1$$

Based on these stoichiometric relationships, 1.03 mg of oxygen are required to mineralize 1 mg of benzene. Similar calculations can be made for toluene, ethylbenzene, and the xylenes. Based on this, approximately 0.97 mg of BTEX is mineralized to carbon dioxide and water for every 1.0 mg of DO consumed. With a background DO concentration of approximately 6 mg/L, the shallow ground water at this site has the capacity to assimilate 5.8 mg/L (5,800 $\mu\text{g/L}$) of total BTEX if microbial cell mass production is taken into account.

4.3.2.2 Nitrate/Nitrite

Concentrations of nitrate + nitrite (as N) were measured at Geoprobe[®] locations and monitoring points/wells in August 1993, November 1993, December 1993/January 1994, and July 1994. In addition, ground water samples were collected and analyzed for ionic nitrate and nitrite in December 1993/January 1994. Table 4.5 summarizes measured nitrate and nitrite concentrations. Figure 4.8 is an isopleth map showing the distribution of nitrate + nitrite (as N) in ground water in August 1993. Figure 4.9 is an isopleth map showing the distribution of nitrate + nitrite (as N) in ground water in July 1994. These figures include data collected from monitoring wells in the source area north of Sixth Street in December 1993/January 1994. These wells cover a small area and these data represent the only data available for this area. Comparison of Figures 4.4 and 4.8 and Figures 4.5 and 4.9, shows graphically that areas with elevated total BTEX concentrations have depleted nitrate + nitrite concentrations. Comparison of Figures 4.6 and 4.8 and Figures 4.7 and 4.9, shows graphically that areas with depleted DO concentrations have depleted nitrate + nitrite concentrations. These relationships provide strong evidence that anaerobic biodegradation of the BTEX compounds is occurring at the site through the microbially mediated process of denitrification.

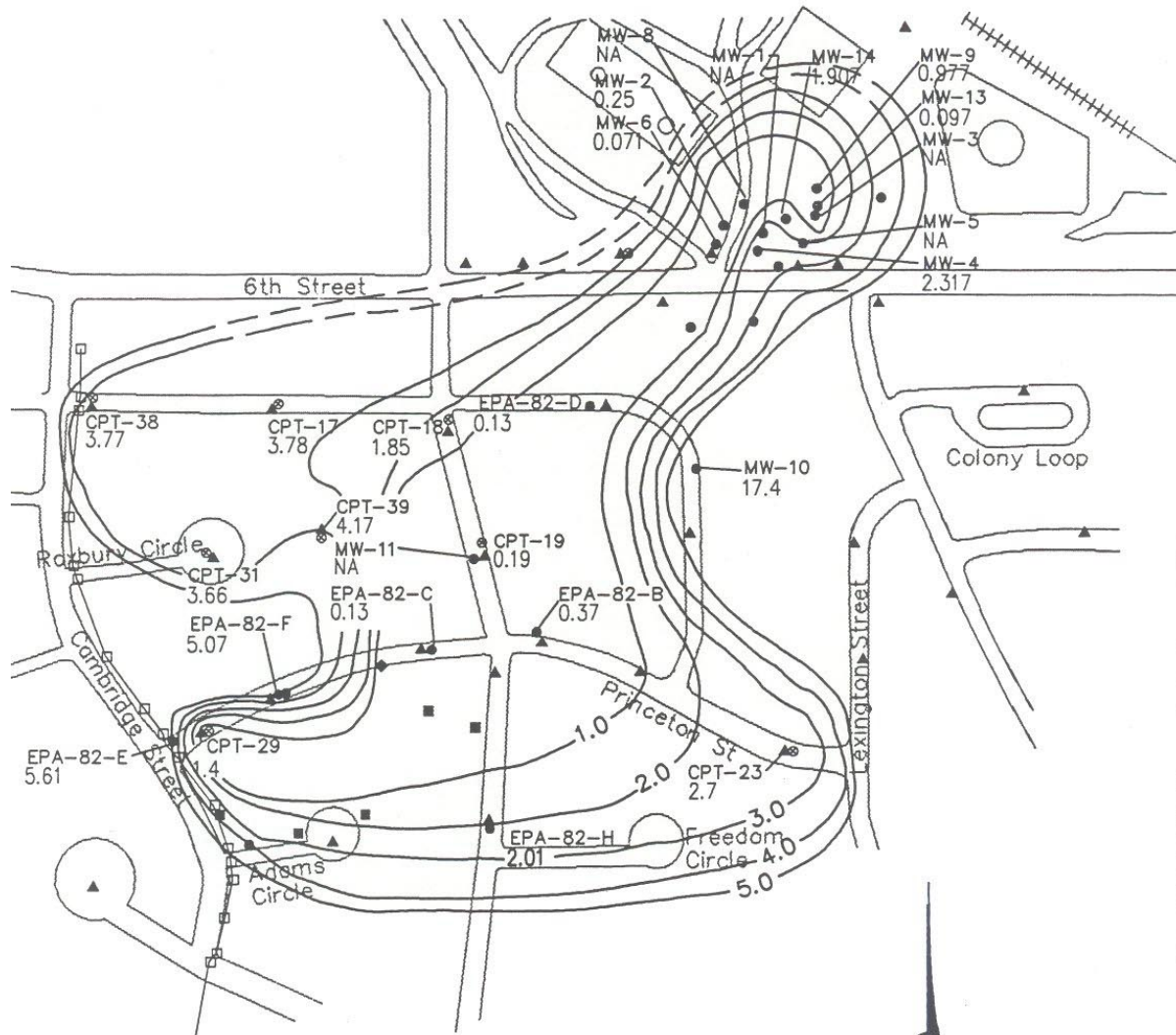

LEGEND

- CPT-26 ▲ CONE PENETROMETER TEST POINT/
PIEZOMETER
 - MW-11 ● MONITORING WELL LOCATION
 - AUGUST 1993 GEOPROBE SAMPLING
LOCATION
 - STORM DRAIN SURVEY LOCATION
 - EPA-82-M ■ JULY 1994 GEOPROBE SAMPLING
LOCATION
 - EPA-82-KK ◆ JULY 1994 SOIL BORING LOCATION
 - 3 — LINE OF EQUAL NITRATE AND
NITRITE CONCENTRATION (mg/L)
(AUGUST 1993, DECEMBER
1993 THROUGH JANUARY 1994)
(DASHED WHERE INFERRED)
- CONTOUR INTERVAL = 1 mg/L

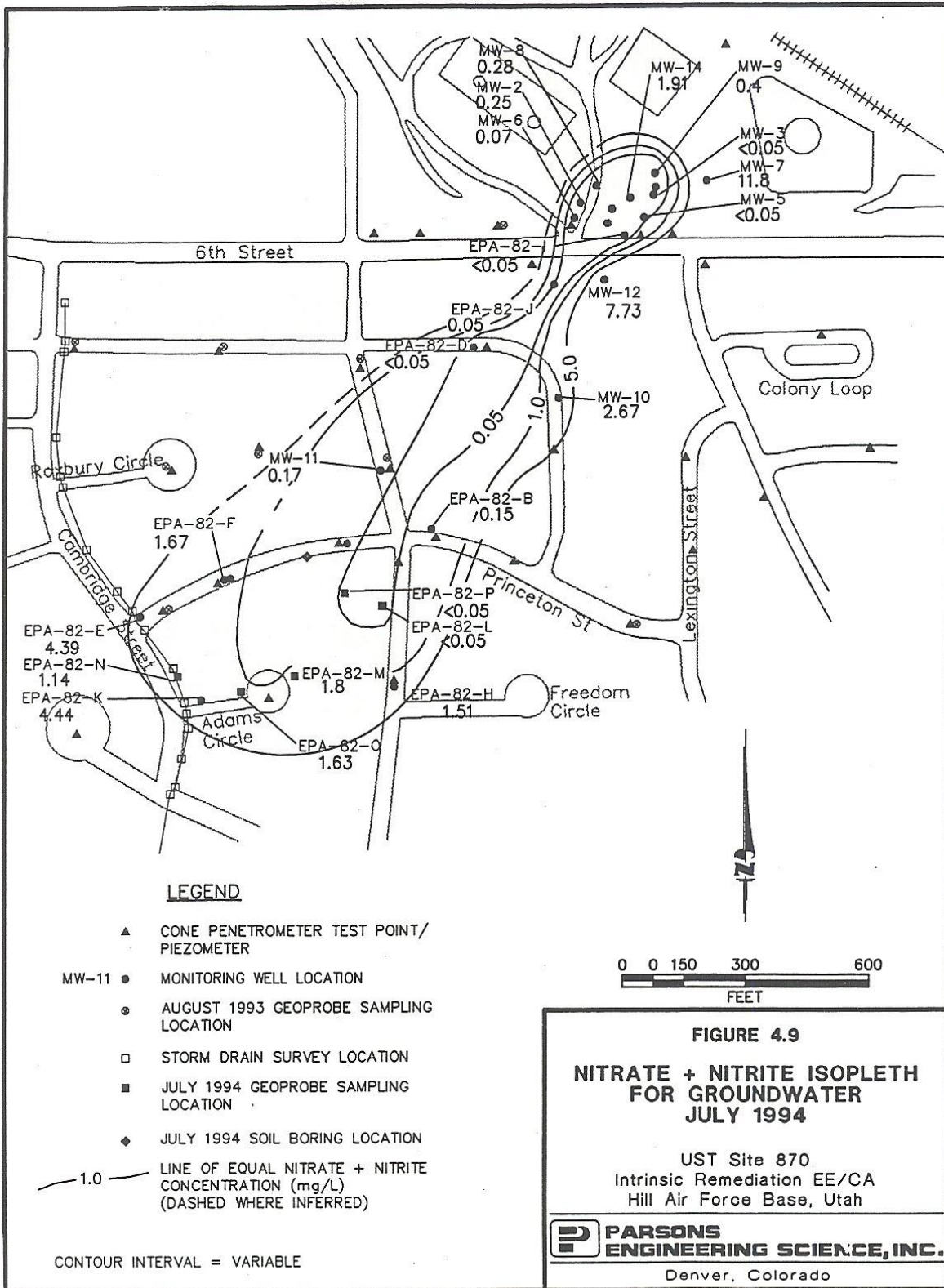

FIGURE 4.8
NITRATE + NITRITE
ISOPLETH FOR GROUNDWATER
AUGUST 1993

UST Site 870
 Intrinsic Remediation EE/CA
 Hill Air Force Base, Utah

PARSONS
ENGINEERING SCIENCE, INC.

Denver, Colorado



In the absence of microbial cell production, the biodegradation of benzene to carbon dioxide and water is given by:

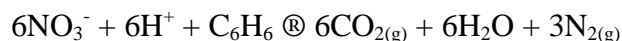

Based on this relationship, 6 moles of nitrate are required to mineralize 1 mole of benzene. On a mass basis, the ratio of nitrate to benzene is given by:

Molecular weights:	Benzene	$6(12) + 6(1) = 78$ gm/mole
	Nitrate	$6(62) = 372$ gm/mole

$$\text{Mass ratio of nitrate to benzene} = 372/78 = 4.77:1$$

In the absence of microbial cell production, 4.77 mg of nitrate are required to completely mineralize 1 mg of benzene. Similar calculations can be completed for toluene (4.85 mg nitrate to 1 mg toluene), ethylbenzene (4.92 mg nitrate to 1 mg ethylbenzene), and the xylenes (4.92 mg nitrate to 1 mg xylene). The average mass ratio of nitrate consumed to total BTEX degraded is 4.9:1. This means that approximately 0.21 mg of BTEX is mineralized for every 1.0 mg of nitrate consumed. With a background nitrate concentration of approximately 17 mg/L, the shallow ground water at this site has the capacity to assimilate 3.57 mg/L (3,570 $\mu\text{g/L}$) of total BTEX during denitrification. This is a very conservative estimate of the assimilative capacity of nitrate because microbial cell mass production has not been taken into account by the stoichiometry shown above (see Section 4.3.2.1).

4.3.2.3 Ferrous Iron

Ferrous iron concentrations were measured at Geoprobe[®] locations and monitoring points/wells in August 1993, November 1993, December 1993/January 1994, and July 1994. Table 4.5 summarizes ferrous iron concentrations. Figure 4.10 is an isopleth map showing the distribution of ferrous iron in ground water in August 1993. Figure 4.11 is an isopleth map showing the distribution of ferrous iron in ground water in July 1994. These figures include data collected from monitoring wells in the source area north of Sixth Street in December 1993/January 1994. These wells cover a small area and these data represent the only data available for this area. Comparison of Figures 4.4 and 4.10 and Figures 4.5 and 4.11 shows graphically that areas with elevated total BTEX concentrations have elevated ferrous iron

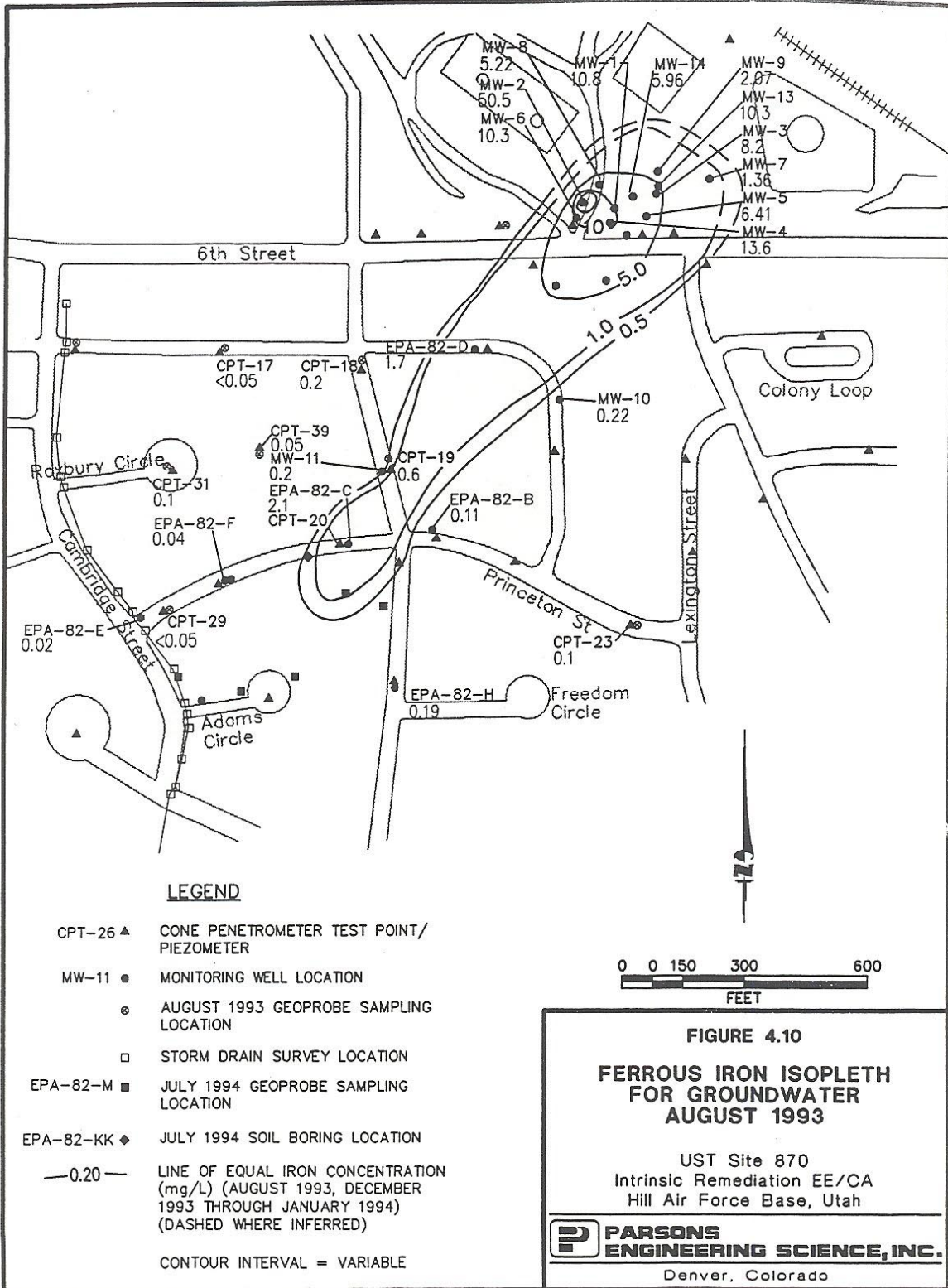

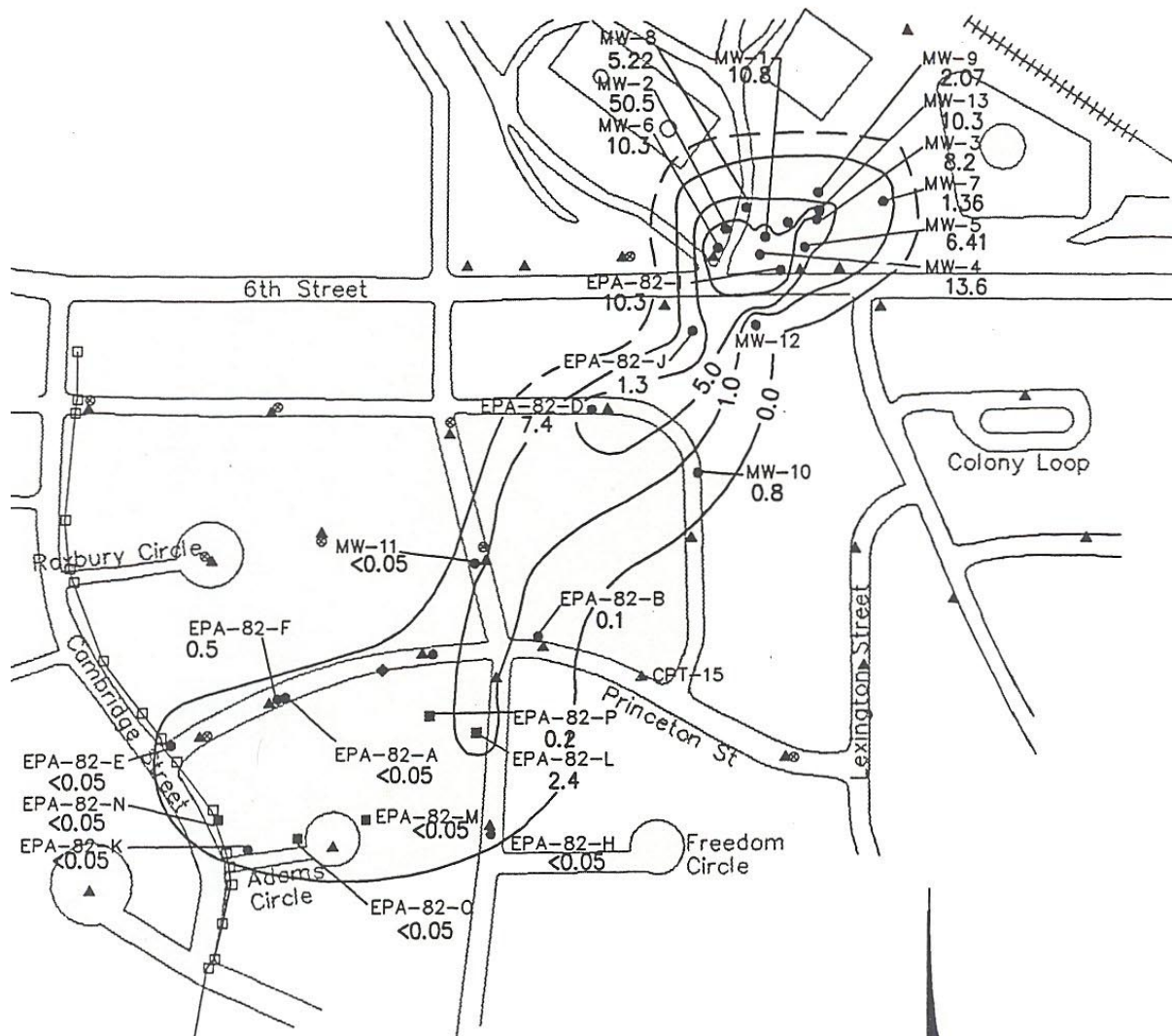

LEGEND

- CPT-26 ▲ CONE PENETROMETER TEST POINT/
PIEZOMETER
- MW-11 ● MONITORING WELL LOCATION
- AUGUST 1993 GEOPROBE SAMPLING
LOCATION
- STORM DRAIN SURVEY LOCATION
- EPA-82-M ■ JULY 1994 GEOPROBE SAMPLING
LOCATION
- EPA-82-KK ◆ JULY 1994 SOIL BORING LOCATION
- 1.0 — LINE OF EQUAL FERROUS IRON
CONCENTRATION (mg/L)
(DASHED WHERE INFERRED)

CONTOUR INTERVAL = VARIABLE



FIGURE 4.11

**FERROUS IRON ISOPLETH
FOR GROUNDWATER
JULY 1994**

UST Site 870
Intrinsic Remediation EE/CA
Hill Air Force Base, Utah

**PARSONS
ENGINEERING SCIENCE, INC.**

Denver, Colorado

concentrations. This is an indication that ferric iron is potentially being reduced to ferrous iron during biodegradation of BTEX compounds. However, it is possible that sulfate reduction at the site is reducing the redox potential of the ground water to sufficiently low levels to cause the dissolution of iron-bearing minerals in the shallow saturated soils at the site, thus elevating ferrous iron concentrations through non-biological processes. The highest measured ferrous iron concentration was 50.5 mg/L at monitoring well MW-02. Background levels of ferrous iron are at or below 0.05 mg/L, as measured at wells located outside of known BTEX contamination depicted on Figures 4.4 and 4.5.

The following equations describe the overall stoichiometry of benzene biodegradation by iron reduction through microbial biodegradation. In the absence of microbial cell production, the biodegradation of benzene is given by:

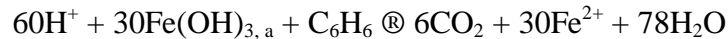

Therefore, 30 moles of $\text{Fe}(\text{OH})_3$ are required to mineralize 1 mole of benzene. On a mass basis, the ratio of $\text{Fe}(\text{OH})_3$ to benzene is given by:

Molecular weights:	Benzene	$6(12) + 6(1) = 78$ gm/mole
	$\text{Fe}(\text{OH})_3$	$30(106.85) = 3205$ gm/mole

$$\text{Mass ratio of } \text{Fe}(\text{OH})_3 \text{ to benzene} = 3205.41/78 = 41.1:1$$

Therefore, in the absence of microbial cell production, 41.1 mg of $\text{Fe}(\text{OH})_3$ are required to completely mineralize 1 mg of benzene. Alternatively, the mass ratio of ferrous iron produced during respiration to benzene degraded can be calculated and is given by:

Molecular weights:	Benzene	$6(12) + 6(1) = 78$ gm/mole
	Fe^{2+}	$30(55.85) = 1675.5$ gm/mole

$$\text{Mass ratio of } \text{Fe}^{2+} \text{ to benzene} = 1675.5/78 = 21.5:1$$

Therefore, 21.5 mg of Fe^{2+} are produced during biodegradation of 1 mg of benzene. Similar calculations can be completed for toluene (21.86 mg of Fe^{2+} produced during biodegradation of 1 mg of toluene), ethylbenzene (22.0 mg of Fe^{2+} produced during biodegradation of 1 mg of ethylbenzene), and the xylenes (22.0 mg of Fe^{2+} produced during biodegradation of 1 mg of xylene). The average mass ratio of Fe^{2+} produced during total BTEX biodegradation is thus 21.8:1. This means that approximately 1 mg of BTEX is mineralized for every 21.8 mg of Fe^{2+} produced. The highest measured Fe^{2+} concentration was 50.5 mg/L. This suggests that the shallow ground water at this site has the capacity to assimilate 2.3 mg/L (2,300 $\mu\text{g/L}$) of total

BTEX during iron reduction. Again, this is a very conservative estimate of the assimilative capacity of iron because microbial cell mass production has not been taken into account by the stoichiometry shown above (see Section 4.3.2.1). In addition, this calculation is based on observed ferrous iron concentrations and not on the amount of ferric hydroxide available in the aquifer. Therefore, iron assimilative capacity could be much higher.

4.3.2.4 Sulfate

Sulfate concentrations were measured at Geoprobe[®] locations and monitoring points/wells in August 1993, November 1993, December 1993/January 1994, and July 1994. Table 4.5 summarizes measured sulfate concentrations. Figure 4.12 is a map showing sulfate concentrations in ground water in August 1993. There does not appear to be any clear trend between BTEX and sulfate concentrations downgradient of the source (compare Figure 4.12 to Figure 4.5) and near the leading edge of BTEX contamination in August 1993. Figure 4.13 is an isopleth map showing the distribution of sulfate in ground water in July 1994. This figure includes data collected from monitoring wells in the source area north of Sixth Street in December 1993/January 1994. These wells cover a small area and these data represent the only data available for this area. Comparison of Figures 4.5 and 4.13, shows graphically that by July 1994, areas with elevated total BTEX concentrations had depleted sulfate concentrations. This is a strong indication that anaerobic biodegradation of the BTEX compounds is occurring at the site through the microbially mediated process of sulfanogenesis.

The following equations describe the overall stoichiometry of BTEX oxidation by sulfate reduction caused by anaerobic microbial biodegradation. In the absence of microbial cell production, the biodegradation of benzene is given by:

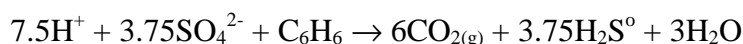

Therefore, 3.75 moles of sulfate are required to mineralize 1 mole of benzene. On a mass basis, the ratio of sulfate to benzene is given by:

Molecular weights:	Benzene	$6(12) + 6(1) = 78$ gm/mole
	Sulfate	$3.75(96) = 360$ gm/mole

$$\text{Mass ratio of sulfate to benzene} = 360/78 = 4.6:1$$

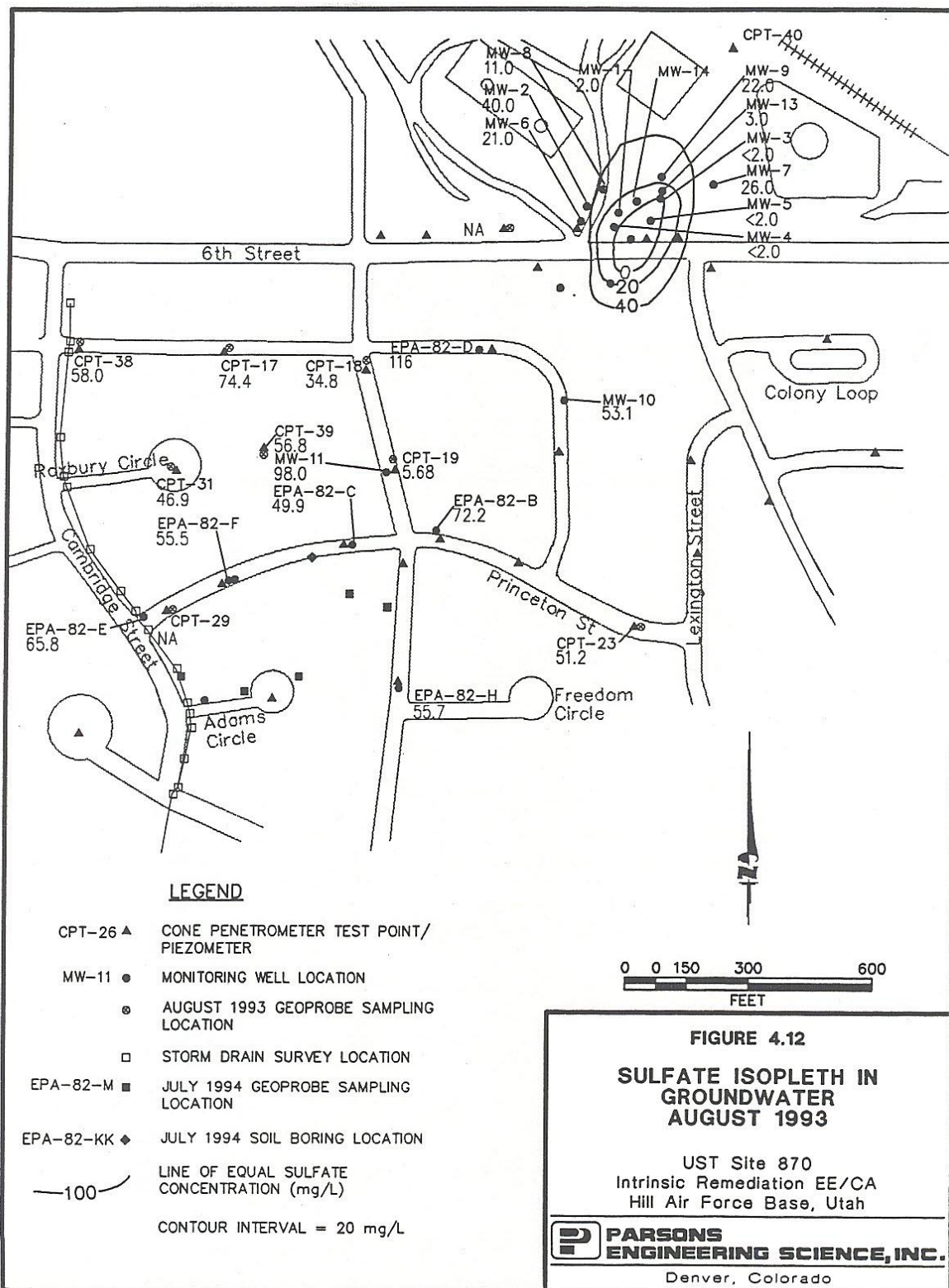

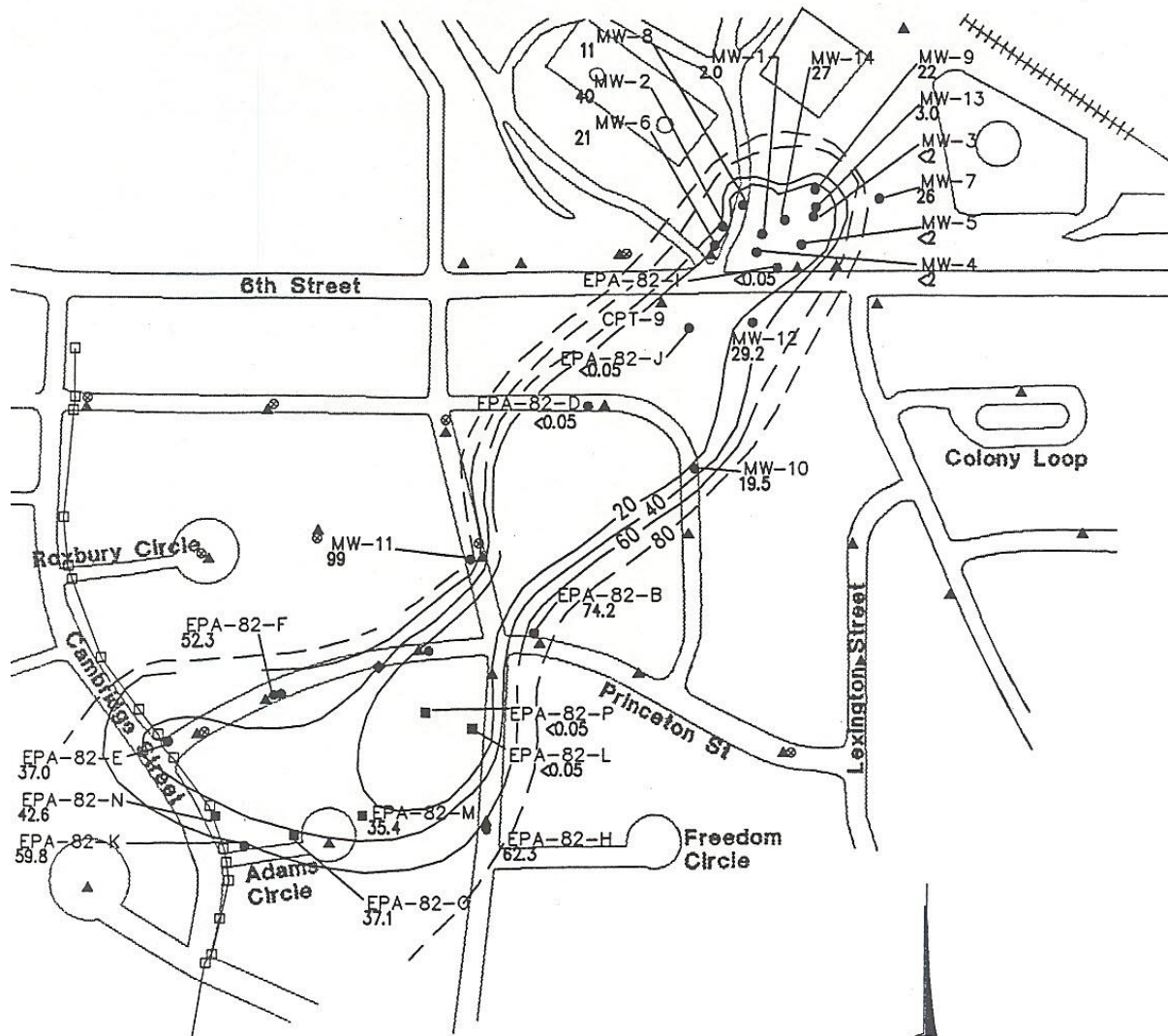

LEGEND

- CPT-26 ▲ CONE PENETROMETER TEST POINT/PIEZOMETER
- MW-11 ● MONITORING WELL LOCATION
- ⊙ AUGUST 1993 GEOPROBE SAMPLING LOCATION
- STORM DRAIN SURVEY LOCATION
- EPA-82-M ■ JULY 1994 GEOPROBE SAMPLING LOCATION
- EPA-82-KK ◆ JULY 1994 SOIL BORING LOCATION
11.0
- 20.0 — LINE OF EQUAL SULFATE CONCENTRATION (mg/L)
(DASHED WHERE INFERRED)
- CONTOUR INTERVAL = 20 mg/L



FIGURE 4.13

SULFATE ISOPLETH FOR GROUND WATER JULY 1994

UST Site 870
Intrinsic Remediation EE/CA
Hill Air Force Base, Utah

PARSONS ENGINEERING SCIENCE, INC.

Denver, Colorado

Therefore, in the absence of microbial cell production, 4.6 mg of sulfate are required to completely mineralize 1 mg of benzene. Similar calculations can be completed for toluene (4.7 mg sulfate to 1 mg toluene), ethylbenzene (4.75 mg sulfate to 1 mg ethylbenzene), and the xylenes (4.75 mg sulfate to 1 mg xylene). The average mass ratio of sulfate to total BTEX is thus 4.7:1. This means that approximately 0.21 mg of BTEX is mineralized for every 1.0 mg of sulfate consumed. Assuming a background sulfate concentration of 100 mg/L, the shallow ground water at this site has the capacity to assimilate 21 mg/L (21,000 µg/L) of total BTEX during sulfanogenesis. Again, this is a very conservative estimate of the assimilative capacity of sulfate because microbial cell mass production has not been taken into account by the stoichiometry shown above (see Section 4.3.2.1).

4.3.2.5 Methane

Methane concentrations were measured at Geoprobe[®] locations and monitoring points/wells in August 1993, November 1993, and December 1993/January 1994. Table 4.5 summarizes methane concentrations. Background levels of methane appear to be below 0.001 mg/L at wells located outside areas with known BTEX contamination. The highest methane concentration observed at the site was 2.04 mg/L in MW-5. Figure 4.14 is an isopleth map showing the distribution of methane in ground water in August 1993. Figure 4.15 is an isopleth map showing the distribution of methane in ground water in July 1994. These figures include data collected from monitoring wells in the source area north of Sixth Street in December 1993/January 1994. These wells cover a small area and these data represent the only data available for this area. Comparison of Figures 4.4 and 4.14 and Figures 4.5 and 4.15, shows graphically that areas with elevated total BTEX concentrations have elevated methane concentrations. This is a strong indication that anaerobic biodegradation of the BTEX compounds is occurring at the site through the microbially mediated process of methanogenesis.

Comparison of Figures 4.14 and 4.15 suggests that methanogenesis, like sulfanogenesis, may have become a more important BTEX-degradation mechanism between August 1993 and July 1994. This is consistent with other electron acceptor data found at the site with the area having elevated methane concentrations being confined to areas with depleted DO, nitrate, and sulfate concentrations and elevated ferrous iron concentrations (compare Figures 4.6 through 4.15). In addition, comparison of Figures 4.14 and 4.15 suggests that methanogenesis is becoming a more important BTEX degradation mechanism as the BTEX plume matures.

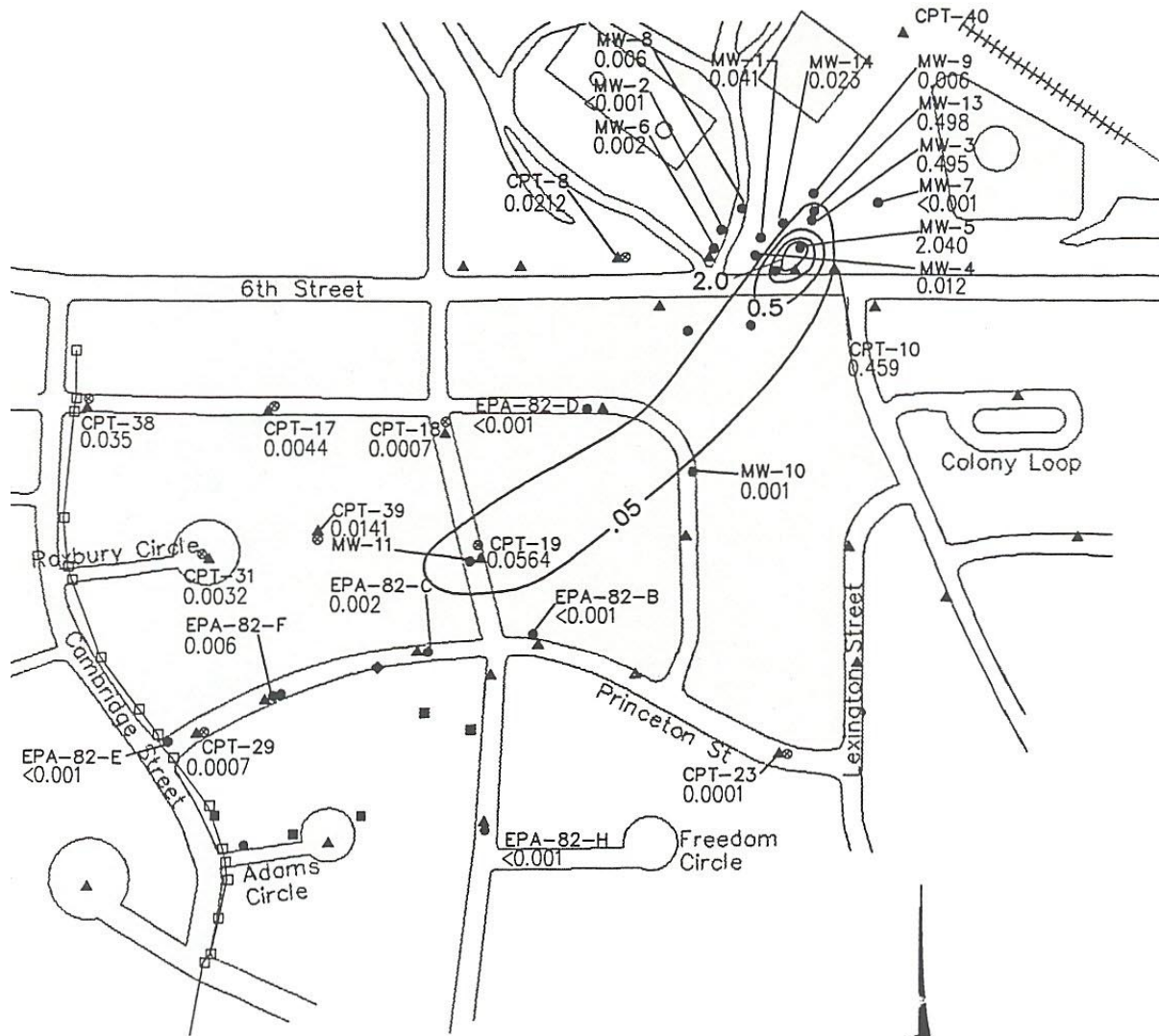

LEGEND

- CPT-26 ▲ CONE PENETROMETER TEST POINT/PIEZOMETER
- MW-11 ● MONITORING WELL LOCATION
- ⊙ AUGUST 1993 GEOPROBE SAMPLING LOCATION
- STORM DRAIN SURVEY LOCATION
- EPA-82-M ■ JULY 1994 GEOPROBE SAMPLING LOCATION
- EPA-82-KK ◆ JULY 1994 SOIL BORING LOCATION
- 0.01 — LINE OF EQUAL METHANE CONCENTRATION (mg/L) (AUGUST 1993, DECEMBER 1993 THROUGH JANUARY 1994)

CONTOUR INTERVAL = VARIABLE

0 0 150 300 600
FEET

FIGURE 4.14
METHANE ISOPLETH FOR GROUNDWATER
AUGUST 1993

UST Site 870
Intrinsic Remediation EE/CA
Hill Air Force Base, Utah

PARSONS
ENGINEERING SCIENCE, INC.

Denver, Colorado

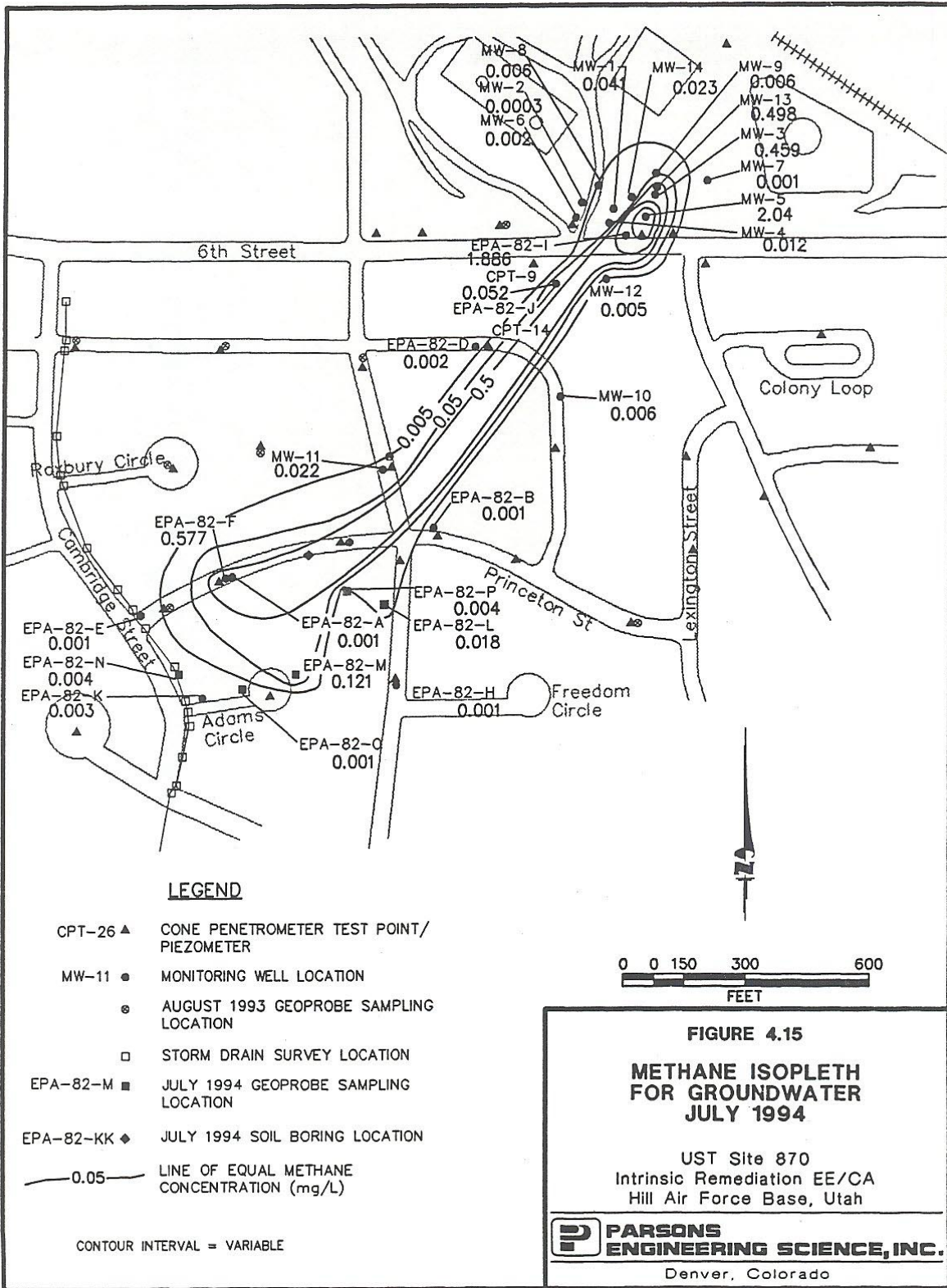

The following equations describe the overall stoichiometry of benzene biodegradation by methanogenesis. In the absence of microbial cell production, the biodegradation of benzene is given by:

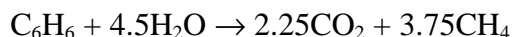

The mass ratio of methane produced during respiration to benzene degraded can be calculated and is given by:

Molecular weights:	Benzene	$6(12) + 6(1) = 78$ gm/mole
	Methane	$3.75(16) = 60$ gm/mole

$$\text{Mass ratio of methane to benzene} = 60/78 = 0.77:1$$

Therefore, 0.77 mg of methane is produced during biodegradation of 1 mg of benzene. Similar calculations can be completed for toluene (0.78 mg of methane produced during biodegradation of 1 mg of toluene), ethylbenzene (0.79 mg of methane produced during biodegradation of 1 mg of ethylbenzene), and the xylenes (0.79 mg of methane produced during biodegradation of 1 mg of xylene). The average mass ratio of methane produced during total BTEX biodegradation is thus 0.78:1. This means that approximately 1 mg of BTEX is mineralized for every 0.78 mg of methane produced. The highest measured methane concentration was 2.04 mg/L. This suggests that the shallow ground water at this site has the capacity to assimilate 2.6 mg/L (2,600 µg/L) of total BTEX during methanogenesis. Again, this is a very conservative estimate of the assimilative capacity of methanogenesis because microbial cell mass production is not taken into account by the stoichiometry shown above (see Section 4.3.2.1). In addition, these calculations are based on observed methane concentrations and not on the amount of carbon dioxide available in the aquifer. Therefore, methanogenic assimilative capacity could be much higher.

4.3.2.6 Reduction/Oxidation Potential

Redox potentials were measured at Geoprobe[®] locations and monitoring points/wells in August 1993, November 1993, December 1993/January 1994, and July 1994. Redox potential is a measure of the relative tendency of a solution to accept or transfer electrons. The redox potential of a groundwater system depends on which electron acceptor is being reduced by microbes during BTEX oxidation. The redox potential at UST Site 870 ranges from 274 millivolts (mV) to -137 mV. Table 4.5 summarizes available redox potential data. Figures 4.16 and 4.17 graphically illustrate the distribution of redox potentials in August 1993 and July 1994, respectively. Redox potential is decreased to a low value of -190 mV in MW-10. Areas at the

site with low redox potentials coincide with areas with high BTEX contamination, low DO, nitrate, and sulfate concentrations, and elevated ferrous iron and methane concentrations (compare Figures 4.4 through 4.17). This suggests that dissolved BTEX at the site may be subjected to a variety of biodegradation processes including aerobic respiration, denitrification, iron reduction, sulfanogenesis, and methanogenesis.

4.3.2.7 Alkalinity

Total alkalinity (as CaCO_3) was measured at Geoprobe[®] locations and monitoring points/wells in August 1993, November 1993, December 1993/January 1994, and July 1994. These measurements are summarized in Table 4.5. Alkalinity is a measure of a ground water's ability to buffer changes in pH caused by the addition of biologically generated acids. Total alkalinity at the site is fairly high, and varies from 959 mg/L at EPA-82-D to 349 mg/L at EPA-82-E. This amount of alkalinity should be sufficient to buffer potential changes in pH caused by biologically mediated BTEX oxidation reactions.

4.3.2.8 pH

pH was measured at Geoprobe[®] locations and monitoring points/wells in August, 1993, November 1993, December 1993/January 1994, and July 1994. These measurements are summarized in Table 4.5. The pH of a solution is the negative logarithm of the hydrogen ion concentration $[\text{H}^+]$. Ground water pH at UST Site 870 ranges from slightly acidic (6.3) to slightly basic (8.3). The majority of ground water has a pH of between 7.1 and 7.4. This range of pH is optimal for BTEX-degrading microbes.

4.3.2.9 Temperature

Ground water temperature was measured at Geoprobe[®] locations and monitoring points/wells in August 1993, November 1993, December 1993/January 1994, and July 1994. Table 4.5 summarizes ground water temperature readings. Temperature affects the types and growth rates of bacteria that can be supported in the ground water environment. Temperatures in the shallow saturated zone vary from 12.9 degrees Celsius ($^{\circ}\text{C}$) to 25°C .

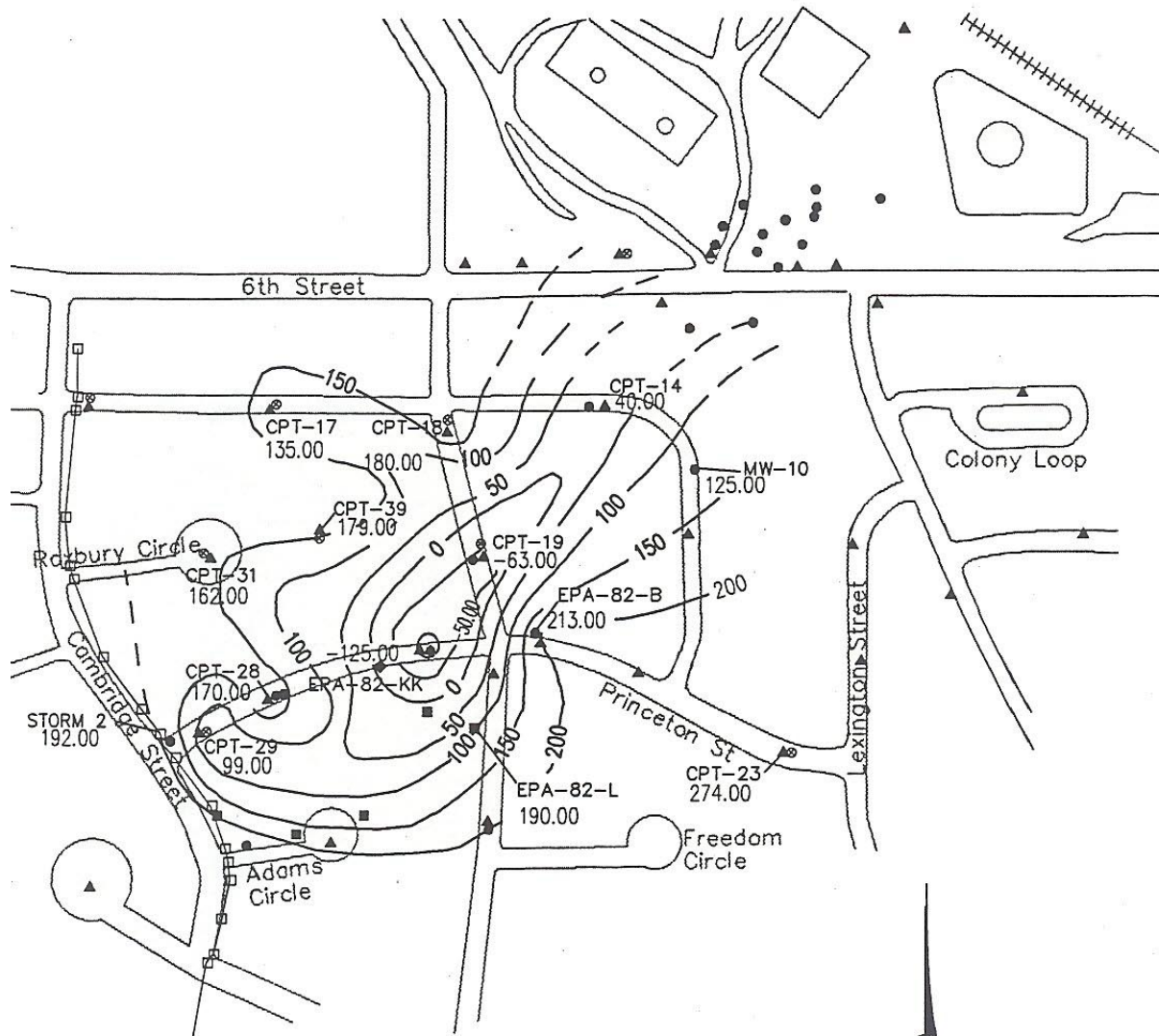

LEGEND

- CPT-26 ▲ CONE PENETROMETER TEST POINT/
PIEZOMETER
- MW-11 ● MONITORING WELL LOCATION
- ⊙ AUGUST 1993 GEOPROBE SAMPLING
LOCATION
- STORM DRAIN SURVEY LOCATION
- EPA-82-M ■ JULY 1994 GEOPROBE SAMPLING
LOCATION
- EPA-82-KK ◆ JULY 1994 SOIL BORING LOCATION
- 100— LINE OF EQUAL
OXIDATION-REDUCTION
POTENTIAL (mV)



FIGURE 4.16
**REDUCTION/OXIDATION
 POTENTIAL MAP
 AUGUST 1993**
 UST Site 870
 Intrinsic Remediation EE/CA
 Hill Air Force Base, Utah

PARSONS
ENGINEERING SCIENCE, INC
 Denver, Colorado

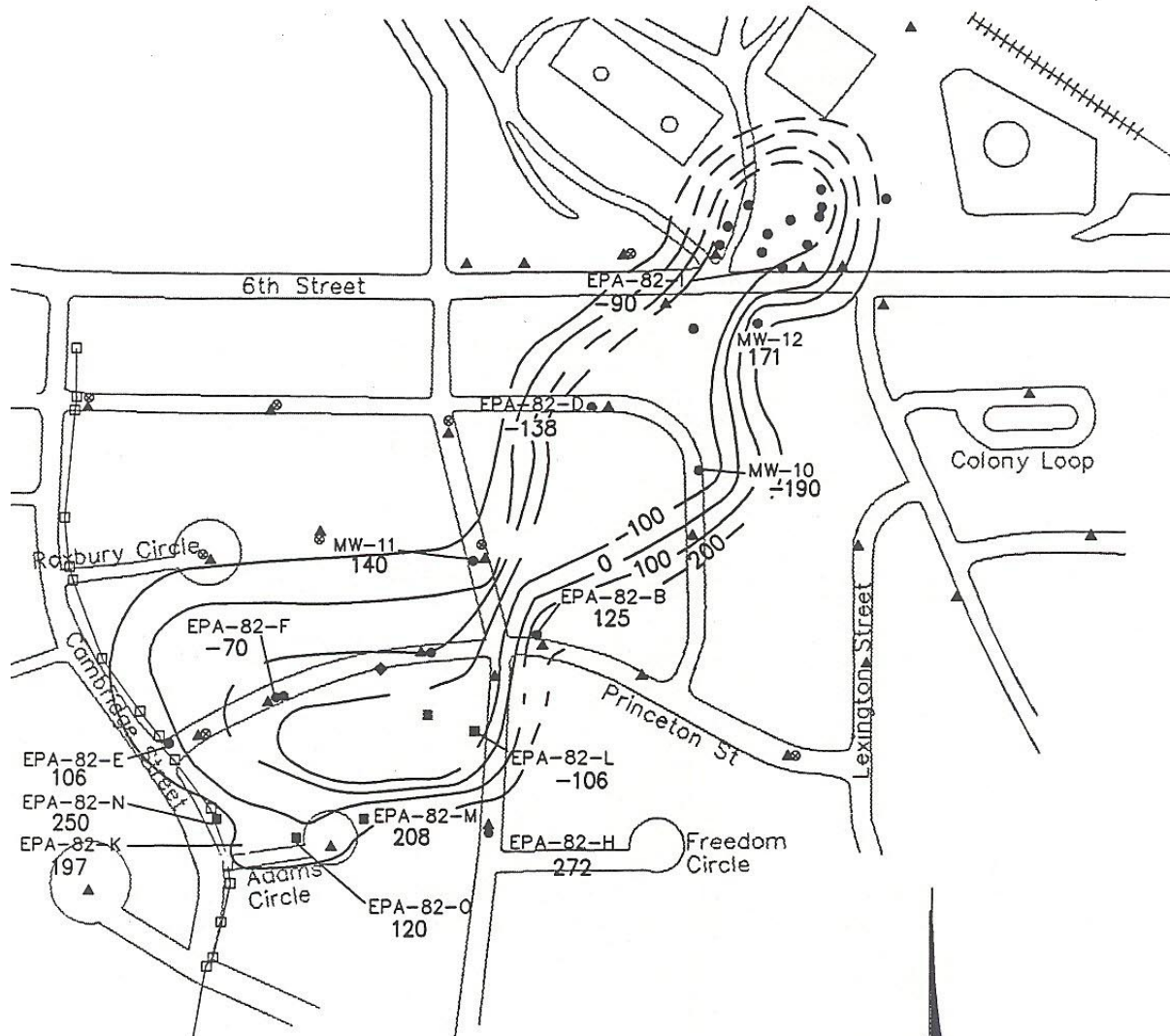

LEGEND

- CPT-26 ▲ CONE PENETROMETER TEST POINT/
PIEZOMETER
- MW-11 ● MONITORING WELL LOCATION
- ⊙ AUGUST 1993 GEOPROBE SAMPLING
LOCATION
- STORM DRAIN SURVEY LOCATION
- EPA-82-M ■ JULY 1994 GEOPROBE SAMPLING
LOCATION
- EPA-82-KK ◆ JULY 1994 SOIL BORING LOCATION
- 100— LINE OF EQUAL REDOX POTENTIAL (mV)
(DASHED WHERE INFERRED)

NOTE: UNLABELED WELL POINTS WERE NOT SAMPLED

FIGURE 4.17
**REDUCTION/OXIDATION
POTENTIAL MAP
JULY 1994**

UST Site 870
Intrinsic Remediation EE/CA
Hill Air Force Base, Utah

PARSONS
ENGINEERING SCIENCE, INC.
Denver, Colorado

4.3.3 Expressed Assimilative Capacity

The data presented in the preceding sections suggest that mineralization of BTEX compounds is occurring through the microbially mediated processes of aerobic respiration, denitrification, iron reduction, sulfanogenesis, and methanogenesis. Based on the stoichiometry presented in these sections, the expressed BTEX assimilative capacity of ground water at UST Site 870 is at least 31,370 µg/L (Table 4.6). The calculations presented in these earlier sections are extremely conservative because they do not account for microbial cell mass production. In addition, the measured concentrations of ferrous iron and methane may not be the maximum achievable. The highest plausible dissolved-phase total BTEX concentration observed at the site was 26,576 µg/L in monitoring well MW-03 in August 1992. The total BTEX concentration in this well in December 1993/January 1994 was 9,466 µg/L. The highest total BTEX concentration observed in July 1994 was 21,475 µg/L.

Based on the calculations presented in the preceding sections, and on site observations, ground water at UST Site 870 has enough assimilative capacity to degrade dissolved-phase BTEX that partitions from the LNAPL plume into the ground water before the plume migrates 1,600 feet downgradient from the source area.

TABLE 4.6
EXPRESSED ASSIMILATIVE CAPACITY OF SITE GROUND WATER
UST SITE 870 INTRINSIC REMEDIATION EE/CA
HILL AFB, UTAH

Electron Acceptor or Process	Expressed BTEX Assimilative Capacity (µg/L)
Dissolved Oxygen	1,900
Nitrate	3,570
Ferric Hydroxide	2,300
Sulfate	21,000
Methanogenesis	2,600
Expressed Assimilative Capacity	31,370
Highest observed Total BTEX Concentration	26,576

SECTION 5

GROUND WATER MODEL

5.1 GENERAL OVERVIEW AND MODEL DESCRIPTION

In order to estimate degradation rates of dissolved-phase BTEX compounds at UST Site 870, and to help predict the future migration of these compounds, ES modeled the fate and transport of the dissolved-phase BTEX plume. The modeling effort had three primary objectives: 1) to predict the future extent and concentration of a dissolved-phase contaminant plume by modeling the combined effects of advection, dispersion, sorption, and biodegradation; 2) to assess the possible risk to potential downgradient receptors; and 3) to provide technical support for the natural attenuation remedial option at post-modeling regulatory negotiations. The model was developed using site-specific data and conservative assumptions about governing physical and chemical processes. Because of the conservative nature of model input, the reduction in contaminant mass caused by natural attenuation is expected to exceed model predictions. This analysis is not intended to represent a baseline assessment of potential risks posed by site contamination.

The Bioplume II computer model was used to estimate the potential for dissolved-phase BTEX migration and degradation by naturally-occurring mechanisms operating at UST Site 870. The Bioplume II model incorporates advection, dispersion, sorption, and biodegradation to simulate BTEX plume migration and degradation. The model is based upon the US Geological Survey Method of Characteristics (USGS MOC) two-dimensional (2-D) solute transport model of Konikow and Bredehoeft (1978). The model was modified by researchers at Rice University to include a biodegradation component that is activated by a superimposed DO plume. Based on the work of Borden and Bedient (1986), the model assumes a reaction between the DO and BTEX that is instantaneous relative to the advective ground water velocity. Bioplume II solves the USGS 2-D solute transport equation twice, once for hydrocarbon concentrations in the aquifer and once for a DO plume. The two plumes are combined using superposition at every particle move to simulate the instantaneous, biologically mediated, reaction between hydrocarbons and oxygen. In recent years it has become apparent that anaerobic processes such as nitrate reduction (denitrification), iron reduction, sulfate reduction (sulfanogenesis), and methanogenesis can be

important BTEX degradation mechanisms (Grbic'-Galic' and Vogel, 1987; Lovely *et al.*, 1989; Grbic'-Galic', 1990; Hutchins, 1991; Beller *et al.*, 1992; Edwards *et al.*, 1992; Edwards and Grbic'-Galic', 1992). As with DO, the reaction between nitrate and BTEX can be assumed to be instantaneous relative to the ground water flow velocity (Wilson, 1994). The Bioplume II model does not allow direct input of nitrate concentrations. Because of this, nitrate concentrations were input as DO-equivalent concentrations. The use of nitrate in this manner allowed the Bioplume II model to more accurately simulate rates of biodegradation at the site. The use of nitrate as a model input parameter is discussed in Section 5.4.5. The following sections discuss in more detail the model setup, input parameters and assumptions, model calibration, and simulation results.

5.2 CONCEPTUAL MODEL DESIGN AND ASSUMPTIONS

Prior to developing a ground water model, it is important to determine if sufficient data are available to provide a reasonable estimate of aquifer hydraulic and geochemical conditions. In addition, it is important to ensure that any limiting assumptions can be justified. The most important assumption made when using the Bioplume II model is that oxygen-limited (and in this case, oxygen/nitrate-limited) biodegradation is occurring at the site. The Bioplume II model assumes that the limiting factors for biodegradation are: 1) the presence of an indigenous hydrocarbon degrading microbial population, and 2) sufficient background electron acceptor levels. Data presented in Sections 3 and 4 indicate that oxygen, nitrate, ferric hydroxide, sulfate, and carbon dioxide (methanogenesis) are all being used for aerobic and anaerobic biodegradation. To be conservative, only oxygen and nitrate are used as electron acceptors in the instantaneous reaction simulated by the Bioplume II model presented herein. To model biodegradation with DO and nitrate as electron acceptors, the isopleth maps for these compounds were superimposed and combined to form a "total" electron acceptor isopleth map. These data were then used for model input.

Based on the data presented in Section 3, the shallow saturated zone was conceptualized and modeled as a shallow unconfined aquifer comprised of medium-grained, moderately sorted sands (Figures 3.3 and 3.4.). With the exception of limited mobile LNAPL removal and bioventing in the spill area, contaminated soils at the site have not been remediated. Additional mobile and residual LNAPL removal would further reduce the continuing source of dissolved-phase BTEX contamination at the site. Several model simulations were conducted; both with LNAPL as a continuing source and with the LNAPL removed through time. Because of the low residual-phase BTEX concentrations observed in soils outside of areas containing mobile LNAPL, it was assumed that these soils represent a minimal source of continuing BTEX contamination. The use

of a two-dimensional model is appropriate at Site UST 870 because the saturated interval is thin (generally less than 3 feet) and a relatively impermeable clayey silt and silty clay confining layer directly underlies the saturated zone. In addition, vertical ground water gradients at the site are upward, as is common over much of the Great Salt Lake Basin.

5.4 MODEL INPUT

Input parameters used for this model are based on a review of existing site data and a review of the pertinent literature. Where site-specific data were not available, reasonable assumptions for the types of materials comprising the shallow saturated zone were made based on widely accepted literature values. Table 5.1 lists the input parameters used for the modeling effort. Appendix D contains gridded data used as model input. Model output is presented in Appendix E as a diskette in ASCII format. The following sections describe the Bioplume II model parameters that have the greatest influence on model predictions.

5.4.1 Grid Design

The maximum grid size for the Bioplume II model is limited to 20 columns by 30 rows. The dimension of each column and row can range from 0.1 to 999.9 feet. A 20- by 30-cell grid was used to model the Hill AFB site. Each grid cell was 110 feet long by 85 feet wide. The grid was oriented so that the longest cell dimension was parallel to the direction of ground water flow (Figure 5.1). The model grid covers an area of 5.6 million square feet, or approximately 129 acres.

Constant-head boundaries were established along the northeast and southwest perimeter of the model grid to simulate the southwestern flow of ground water observed at the site. These constant-head cells were placed at a sufficient distance from the BTEX plume to avoid potential boundary interferences. Injection cells were used to simulate the continuing source of contamination caused by the mobile LNAPL present at the site. Injection well locations are shown in Figure 5.1 and are explained in detail in Section 5.5.

TABLE 5.1
BIOPLUME II MODEL INPUT PARAMETERS
UST SITE 870 INTRINSIC REMEDIATION EE/CA
HILL AFB, UTAH

Parameter	Description	Calibrated Model Setup	Hill-A	Hill-B	Hill-C
NTIM	Max. number of time steps in a pumping period		15	2	2
NPMP	Number of Pumping Periods		1	25	12
NX	Number of nodes in the X direction		20	20	20
NY	Number of nodes in the Y direction		30	30	30
NPMAX	Maximum number of Particles NPMAX=(NX-2)(NY-2)(NPTPND) + (Ne)(NPTPND) + 250		5290	5290	5290
NPNT	Time step interval for printing data	1	1	1	1
NITP	Number of iteration parameters	7	7	7	7
NUMOBS	Number of observation points		5	5	5
ITMAX	Maximum allowable number of iterations in ADIP	200	200	200	200
NREC	Number of pumping or injection wells		20	0	0
NPTPND	Initial number of particles per node	9	9	9	9
NCODES	Number of node identification codes		2	2	2
NPNTMV	Particle movement interval (IMOV)	0	0	0	0
NPNTVL	Option for printing computed velocities	2	1	1	1
NPNTD	Option to print computed dispersion equation coefficients	2	1	1	1
NPDELC	Option to print computed changes in concentration	1	1	1	1
NPNCHV	Option to punch velocity data	0	0	0	0
NREACT	Option for biodegradation, retardation and decay	1	1	1	1
PINT	Pumping period (years)		15	1	1
TOL	Convergence criteria in ADIP	0.001	0.001	0.001	0.001
POROS	Effective porosity		0.25	0.25	0.25
BETA	Characteristic length (long. dispersivity; feet)		53.4	53.4	53.4
S	Storage Coefficient	0 (Steady-State)	0	0	0
TIMX	Time increment multiplier for transient flow		NA	NA	NA
TINIT	Size of initial time step (seconds)		NA	NA	NA
XDEL	Width of finite difference cell in the x direction (feet)		85	85	85
YDEL	Width of finite difference cell in the y direction (feet)		110	110	110
DLTRAT	Ratio of transverse to longitudinal dispersivity	0.1	0.1	0.1	0.1
CELDIS	Maximum cell distance per particle move	0.5	1	0.5	0.5
ANFCTR	Ratio of T _{yy} to T _{xx}	1 (Isotropic)	1	1	1
DK	Distribution coefficient		.05451	.05451	.05451
RHOB	Bulk density of the solid (grams/cubic centimeter)		1.6	1.6	1.6
THALF	Half-life of the solute		0	0	0
DEC1	Anaerobic decay coefficient		0	0	0
DEC2	Reaeration coefficient (day ⁻¹)		.003	.003	.003

NA = Not Applicable

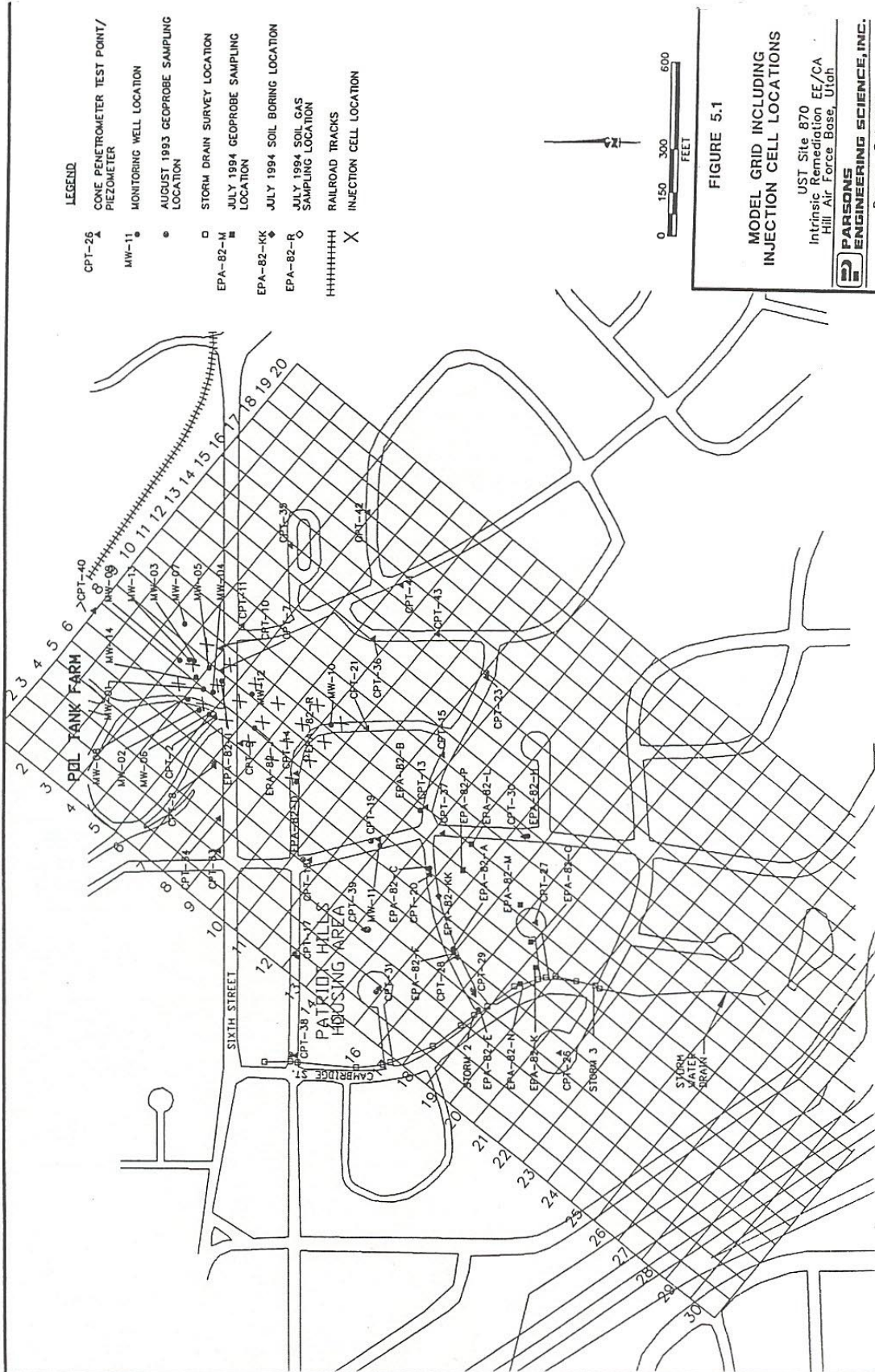

5.4.2 Ground Water Elevation and Gradient

The water table elevation data presented in Figure 3.5 were used as Bioplume II model input. Available site data suggest that there is almost no seasonal variation in ground water flow direction or gradient at the site (Appendix B and MWI, 1994). Ground water flow in the vicinity of UST Site 870 is to the southwest at an average gradient of approximately 0.048 ft/ft between wells EPA-82-I and EPA-82-E. As described in Section 5.5, the ground water flow model was calibrated to the observed water table.

5.4.3 BTEX Concentrations

The highest total-dissolved BTEX concentrations obtained from laboratory analytical data for the period through August 1993 were used for model development. Table 4.4 contains dissolved BTEX concentration data. Figure 4.4 shows the spatial distribution of dissolved-phase BTEX compounds in August 1993. Appendix D contains the gridded total BTEX concentrations used as model input.

The BTEX data from Figure 4.4 was used in model development by placing the model grid over the isopleth contours. The total BTEX concentration used in the model, and shown in APPENDIX D, is an estimated average concentration of all the isopleth lines intersecting the boundaries within each model cell. The highest concentration isopleth lines were not used for allocating BTEX concentrations to model cells because a single isopleth concentration was not representative of the average total BTEX concentrations over the entire 85 feet by 110 feet model cell. Figure 5.2 shows the distribution of the BTEX plume as calculated by the Bioplume II model for T=0 for all models. Comparison of Figures 4.4 and 5.2 shows that there is good agreement between the actual BTEX distribution in the shallow saturated zone and the initial distribution calculated by the Bioplume II model. The initial BTEX plume covers an area of approximately 650,000 square feet (15 acres). The shape and distribution of the total BTEX plume is the result of advective transport of dissolved-phase BTEX contamination downgradient from the LNAPL contamination present in the source area. Partitioning of BTEX compounds from the LNAPL into the ground water is described in Section 5.5.

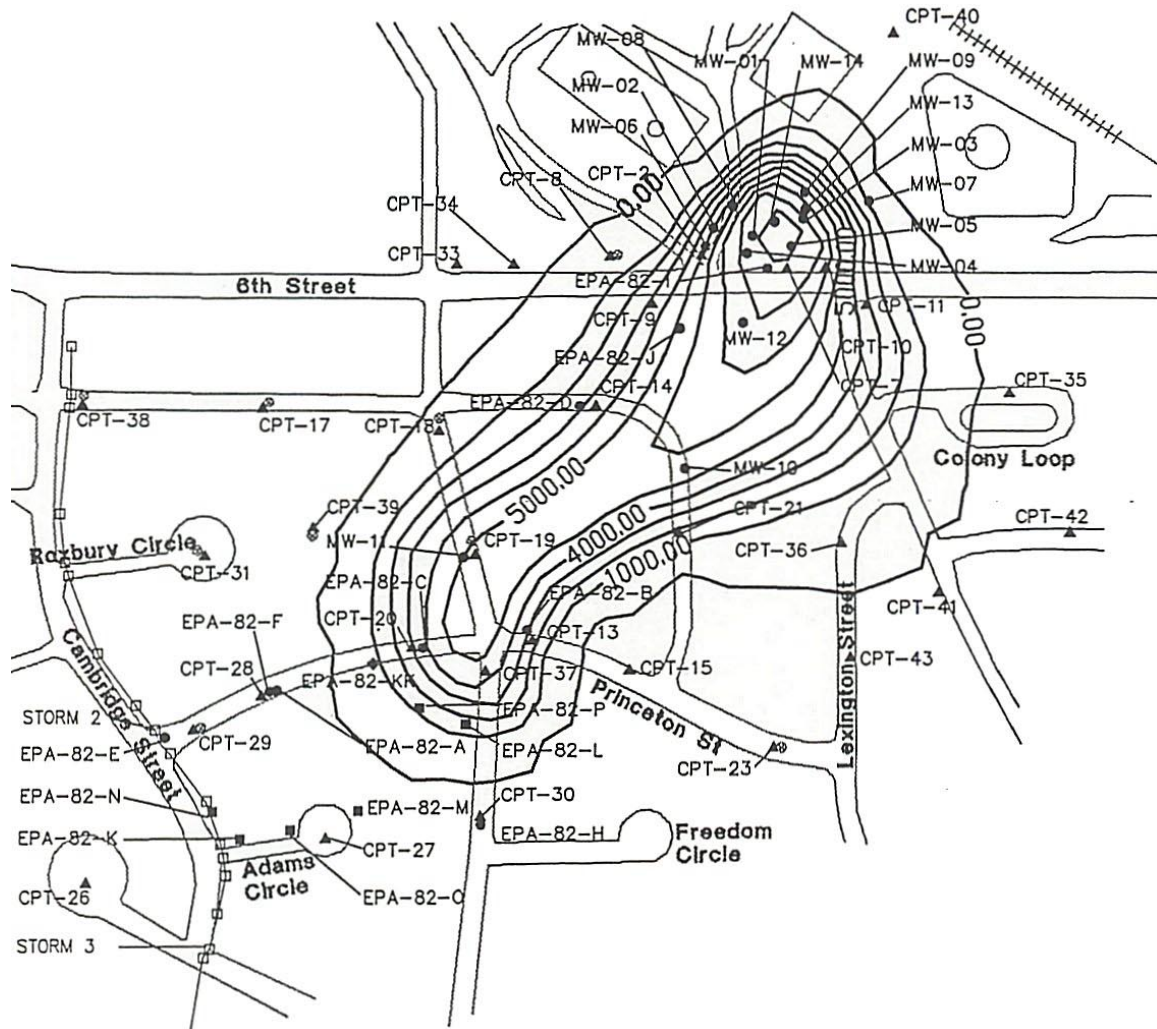

LEGEND

- CPT-26 ▲ CONE PENETROMETER TEST POINT/
PIEZOMETER
 - MW-11 ● MONITORING WELL LOCATION
 - AUGUST 1993 GEOPROBE SAMPLING
LOCATION
 - STORM DRAIN SURVEY LOCATION
 - EPA-82-M JULY 1994 GEOPROBE SAMPLING
 - EPA-82-KK ◆ JULY 1994 SOIL BORING LOCATION
 - 1000— LINE OF EQUAL TOTAL
BTEX CONCENTRATION (µg/L)
- CONTOUR INTERVAL = 1,000 µg/L

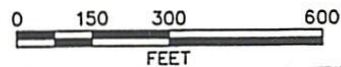

FIGURE 5.2
MODEL RESULTS
TOTAL DISSOLVED BTEX
ALL MODELS
T=0 YEAR
 UST Site 870
 Intrinsic Remediation EE/CA
 Hill Air Force Base, Utah

PARSONS
ENGINEERING SCIENCE, INC.
 Denver, Colorado

5.4.4 Hydraulic Conductivity

Hydraulic conductivity (K) is an important aquifer characteristic that determines the ability of the water-bearing strata to transmit ground water. An accurate estimate of this parameter is important to help quantify advective ground water flow velocities, to define the flushing potential of the aquifer, and to estimate the quantity of electron-acceptor-rich ground water that is entering the site from upgradient locations. Rifai *et al.* (1988) report that the Bioplume II model is particularly sensitive to variations in hydraulic conductivity. Lower values of hydraulic conductivity result in a slower-moving plume that degrades at a slower rate because less oxygen and nitrate are available for biodegradation. Higher values of hydraulic conductivity result in a faster moving plume that degrades at a faster rate because more oxygen and nitrate are available for biodegradation.

Based on slug tests performed at the site, hydraulic conductivity varies from 5.50×10^{-4} ft/s to 2.73×10^{-4} ft/s. This is within the accepted range for sandy materials (Freeze and Cherry, 1979). Slug test results used for modeling do not reflect slug test data collected by JMM (1993) at MW-1. MW-1 was screened in a soil interval characterized by silty sands with a large interval (~4 ft) of clayey sand. As a result, slug test data from MW-1 was not considered representative of the fine- to medium- grained sandy soils located around the screened monitoring wells used for Parsons ES slug test sites in 1993. The sensitivity of the model to this parameter was evaluated during the sensitivity analysis described in Section 5.6.

5.4.5 Electron Acceptors (Oxygen and Nitrate)

As discussed previously, the Bioplume II model assumes an instantaneous reaction between the BTEX plume and the electron acceptors. As discussed in Section 4, it is apparent that DO, nitrate, ferric hydroxide, sulfate and carbon dioxide (methanogenesis) are being used as electron acceptors for biodegradation of BTEX compounds at UST Site 870. However, to be conservative, the total BTEX plume at UST Site 870 was modeled assuming that oxygen and nitrate were the only electron acceptors being utilized at a rate that is instantaneous relative to the advective ground water velocity for the biodegradation of the BTEX compounds.

The Bioplume II model was calibrated with DO as the only electron acceptor. The result of using DO as the only electron acceptor was a modeled BTEX plume that extended nearly twice as far (and past the Hill AFB boundary) downgradient than the plume observed in 1994. Based on these results, it was clear that DO is not the only electron acceptor being utilized for BTEX biodegradation. Successful calibration of the Bioplume II model required the use of nitrate, which is the most thermodynamically favorable electron acceptor following oxygen. Furthermore, decreases in nitrate concentrations from anaerobic biodegradation processes were observed in areas with reduced DO concentrations (compare Figures 4.6 and 4.7 with Figures 4.8 and 4.9, respectively). This strongly suggests both denitrification and aerobic oxidation are important biodegradation mechanisms at the site. Although some localized areas on the fringe of the BTEX plume overestimated the actual rate of denitrification because of background DO concentrations, both aerobic oxygenation and denitrification of BTEX contamination were widely observed in the same areas. Therefore, simulating nitrate concentrations with DO concentrations in the model was not an overgeneralization of site electron acceptor potential (as might initially be presumed), but instead was an improved representation of site conditions. Related modeling initiatives to improve simulations of BTEX biodegradation in ground water systems are being accomplished by incorporating nitrate, and other potential anaerobic electron acceptors (e.g., ferric iron, sulfate, and carbon dioxide) into the model code, specifically within the code of the soon-to-be released Bioplume ground water model (Rifai, 1995).

The loss of DO and nitrate in the Bioplume II model was conceptualized with aerobic bacteria using DO, and then with anaerobic bacteria using nitrate as the next available electron acceptor. This assumption is justified based on the observation that aerobic oxidation and denitrification are important biodegradation mechanisms at the site. Once utilized, DO and nitrate will react instantaneously with BTEX relative to the advective groundwater velocity in the aquifer (Borden and Bedient, 1986; Wilson, 1994).

Ground water samples collected in uncontaminated portions of the aquifer indicate that background DO concentrations at the site are about 6.3 mg/L. To be conservative, background DO concentrations were assumed to be 5.0 mg/L for Bioplume II model development. Table 4.5 contains DO data for the site. Figures 4.6 and 4.7 are DO isopleth maps. Gridded oxygen input data are included in Appendix D.

Ground water samples collected in uncontaminated portions of the aquifer indicate that background nitrate (as N) concentrations at the site may be as high as 17 mg/L. However, to be conservative, nitrate (as N) concentrations around the periphery of the plume were assumed to be

5 mg/L for Bioplume II model development. Table 4.5 contains nitrate data for the site. Figures 4.8 and 4.9 are nitrate isopleth maps. Gridded nitrate data are included in Appendix D.

The upgradient constant-head cells in the Bioplume II model require background electron acceptor concentrations to be input as constant concentrations to simulate incoming electron acceptors. To be conservative, a DO concentration of 5 mg/L and a nitrate (as N) concentration of 10 mg/L was used for these cells.

Bioplume II[®] is capable of tracking only a single electron acceptor as an instantaneous reaction in model simulations (customarily DO) for estimating BTEX biodegradation. Consequentially, the model cannot estimate both DO and nitrate biodegradation mechanisms simultaneously unless one electron acceptor is mathematically converted to an equivalent form of the other. Denitrifying conditions were modeled by converting nitrate concentrations to equivalent oxygen concentrations. On a mass basis, 4.77 mg of ionic nitrate are required to oxidize 1 mg of benzene, whereas, only 3.08 mg of DO are required to oxidize the same mass of benzene. Hence, ionic nitrate has only 64.6 percent of the capacity to biodegrade benzene that DO does. Converted ionic nitrate concentrations were combined with DO concentrations for a total oxygen/ionic nitrate electron acceptor map. It was assumed that oxygen was utilized first by aerobic bacteria and then anaerobic bacteria consumed nitrate as the next available electron acceptor. The calculations used to convert nitrate (as N) to oxygen equivalent ionic nitrate are discussed below.

Nitrate concentrations at UST Site 870 were reported together with nitrite concentrations as nitrate + nitrite (as N) by RSKERL. Based on these data it is not possible to determine the relative amounts of nitrate and nitrite (as N); however, because nitrite is considered metastable in the ground water environment, it was assumed that the combined nitrate + nitrite (as N) value was all nitrate (as N). The work of von Gunten and Zobrist (1993) supports this assumption as does site-specific data (Table 4.5). These workers conducted column experiments using nitrate as an electron acceptor and noted that only small amounts of nitrite were detected in the column in the early stages of the experiment, and after 20 days, nitrite was no longer detected.

The use of nitrate as an electron acceptor requires that nitrate (as N) concentrations be converted to ionic nitrate concentrations. To do this, the equivalent weight of oxygen must be added back to the nitrate (as N) concentration:

Molecular weight of N = 14 gm/mole
Molecular weight of O = 16 gm/mole
Molecular weight of NO₃⁻ = 62 gm/mole

The percentage of N in NO_3^- is $14/62 = 22.58$ percent. Therefore, 1 gm of NO_3^- (as N) is equivalent to $1/0.2258 = 4.43$ gm of ionic NO_3^- . To convert nitrate (as N) into ionic nitrate concentrations, the measured nitrate (as N) concentration must be multiplied by 4.43.

Assuming complete mineralization of benzene to carbon dioxide and water, the reactions for aerobic respiration and denitrification are as follow:

Aerobic Respiration

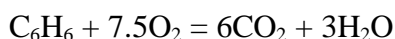

Denitrification

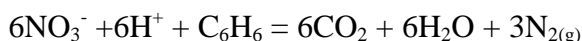

Based on this stoichiometry, 7.5 moles of DO are required to biodegrade 1 mole of benzene, and 6 moles of nitrate are required to biodegrade 1 mole of benzene. On a mass basis:

$$\begin{aligned} (7.5 \text{ moles O}_2)(32 \text{ gm/mole O}_2) &= 240 \text{ gm O}_2 \\ (6 \text{ moles NO}_3^-)(62 \text{ gm/mole NO}_3^-) &= 372 \text{ gm NO}_3^- \end{aligned}$$

From these relationships, it is apparent that, on a mass basis, more ionic nitrate than DO is required to oxidize a unit mass of benzene. By dividing the mass of ionic nitrate required to degrade one mole of benzene by the mass of DO required to degrade one mole of benzene, a ratio is derived that can be applied to ionic nitrate concentrations to obtain equivalent oxygen concentrations. This ratio is:

$$240 \text{ gm O}_2 / 372 \text{ gm NO}_3^- = 0.645 \text{ gm of O}_2 \text{ equivalent per gram of NO}_3^-$$

Therefore, 10 gm of NO_3^- has an O_2 equivalence of:

$$(10 \text{ gm NO}_3^-)(0.645 \text{ gm of O}_2 \text{ equivalent/gm of NO}_3^-) = 6.45 \text{ gm}$$

From these relationships, the following calculation must be performed to convert NO_3^- (as N) to an equivalent DO concentration:

$$(\text{NO}_3^- \text{ (as N) (gm/L)})(4.43 \text{ gm NO}_3^- \text{ (ion)/gm NO}_3^- \text{ (as N)})(0.65 \text{ gm O}_2 \text{ eq./gm NO}_3^-)$$

This relationship was used to convert measured nitrate (as N) concentrations into oxygen-equivalent ionic nitrate concentrations. To do this an isopleth map of nitrate (as N) was prepared and gridded. Gridded values of nitrate (as N) were then used in the relationship presented above

to determine ionic NO_3^- as DO equivalence. These values were then added to existing DO concentrations previously gridded at the site and used as input into the Bioplume II model.

5.4.5 Dispersivity

Much controversy surrounds the concepts of dispersion and dispersivity. Longitudinal dispersivity values for alluvial sediments range from 0.1 to 200 feet (Walton, 1988). A longitudinal dispersivity of 53.4 feet was used in this model. This dispersivity was estimated by using one-tenth of the distance between the spill source and the longitudinal centroid of the plume. Transverse dispersivity values generally are at least one order of magnitude less than values of longitudinal dispersivity (Domenico and Schwartz, 1990). For this model, ES used 0.1 for the ratio of transverse dispersivity to longitudinal dispersivity. Use of an estimated value for dispersivity is appropriate because the Bioplume II model exhibits a weak sensitivity to dispersivity (Rifai *et al.*, 1988). In addition, the sensitivity of the model to the parameter was evaluated during the sensitivity analyses described in Section 5.6.

5.4.6 Retardation

Retardation of the BTEX compounds relative to the advective velocity of the ground water occurs when BTEX molecules are sorbed to the aquifer matrix. Based on measured TOC concentrations in an uncontaminated portion of the shallow saturated zone, and assuming a bulk density of 1.6 grams per cubic centimeter (gm/cc) (Freeze and Cherry, 1979), and published values of K_{oc} for the BTEX compounds (Martel, 1987), the coefficient of retardation for the BTEX compounds was calculated. The results of these calculations are summarized in Table 5.2. To be conservative, the minimum coefficient of retardation calculated for benzene (1.29) was used as model input.

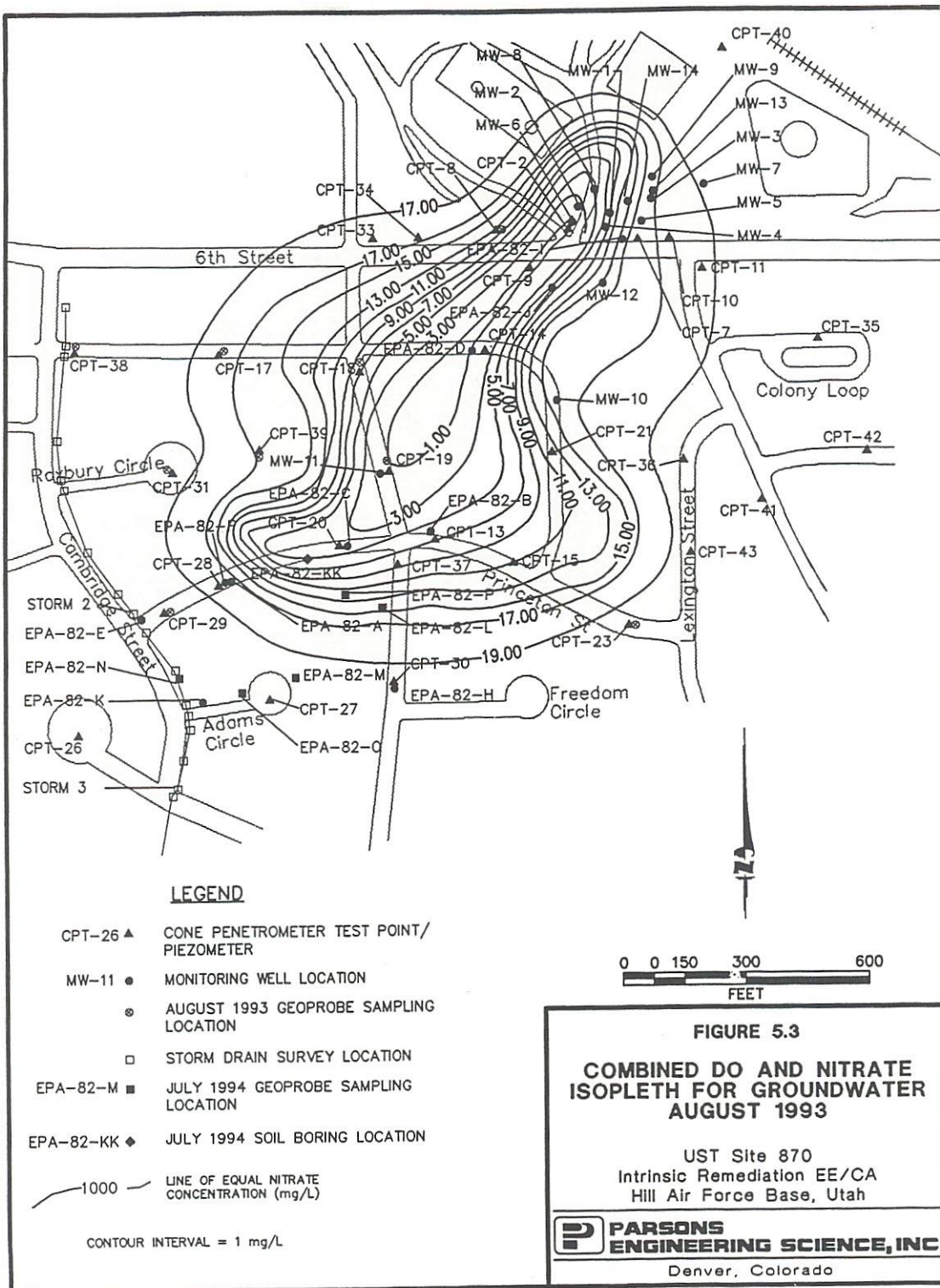

5.4.7 Reaeration

The reaeration coefficient is a first-order rate constant used by Bioplume II to simulate the replenishment of oxygen into the ground water by soil gas diffusion and rainwater infiltration. Recent data on first-order biodegradation rate coefficient in groundwater at Hill AFB suggest that biodegradation rates ranged from 0.010 to 0.032 day⁻¹ over the center and periphery of the groundwater contaminant plume (Wiedemeier *et al.*, 1994). To be conservative, a first-order biodegradation rate coefficient of 0.003 day⁻¹ was used in this model. This rate coefficient was increased and decreased by one order of magnitude during the sensitivity analyses described in Section 5.6.

5.5 MODEL CALIBRATION

Model calibration is an important component in the development of any numerical ground water model. Calibration of the flow model demonstrates that a model is capable of matching hydraulic and chemical conditions observed in the field. The numerical model presented herein was calibrated by altering hydraulic parameters, boundary conditions, and stresses (i.e., injection cells) in a trial-by-error fashion until simulated heads and BTEX plumes approximated observed field conditions.

5.5.1 Water Table Calibration

The shallow water table at UST Site 870 was assumed to be influenced only by continuous recharge and discharge at the constant-head cells established at the upgradient and downgradient model boundaries. To be conservative, annual recharge of the aquifer through rainfall was not included in the model. Potential recharge by leaky stormwater sewers, collection ponds, or other sources was omitted because of a lack of reliable data. Only the initial water levels at the constant-head cells and the transmissivity were varied to calibrate the water table surface. The model was calibrated under steady-state conditions.

TABLE 5.2

**RETARDATION CALCULATIONS FOR THE BTEX COMPOUNDS
UST SITE 870 INTRINSIC REMEDIATION EE/CA
HILL AFB, UTAH**

Compound	K _{oc} (L/Kg ^{a/})	Maximum Fraction Organic Carbon ^{b/}	Minimum Fraction Organic Carbon ^{b/}	Distribution Coefficient (L/Kg)		Bulk Density (Kg/L) ^{d/}	Effective Porosity ^{e/}	Coefficient of Retardation	
				Maximum ^{c1/}	Minimum ^{c2/}			Maximum	Minimum
Benzene	79	0.00094	0.00069	0.07426	0.05451	1.60	0.30	1.40	1.29
Toluene	190	0.00094	0.00069	0.1786	0.1311	1.60	0.30	1.95	1.70
Ethylbenzene	468	0.00094	0.00069	0.43992	0.32292	1.60	0.30	3.35	2.72
m-xylene	405	0.00094	0.00069	0.3807	0.27945	1.60	0.30	3.03	2.49
o-xylene	422	0.00094	0.00069	0.39668	0.29118	1.60	0.30	3.12	2.55
p-xylene	357	0.00094	0.00069	0.33558	0.24633	1.60	0.30	2.79	2.31

NOTES:
a/ From technical protocol (Engineering-Science, Inc., 1994)
b/ From site data
c1/ $K_d = \text{Maximum Fraction Organic Carbon} \times K_{oc}$
c2/ $K_d = \text{Minimum Fraction Organic Carbon} \times K_{oc}$
d/ From site data
e/ Literature values

Saturated thickness data from borehole logs, CPT reports, and water level measurements were used in conjunction with the average hydraulic conductivity as determined from slug tests (2.64×10^{-4} ft/s) to estimate transmissivity. To better match heads in the model to observed values, the transmissivities were progressively varied in rows and blocks until the potentiometric surface approximated the existing potentiometric surface within a 5-percent average variance. Thirteen monitoring wells and piezometer locations were used to compare between the measured and simulated heads of the final calibrations. The 13 selected locations were EPA-82-I, EPA-82-D, EPA-82-B, EPA-82-C, EPA-82-F, EPA-82-E, EPA-82-H, CPT-41, CPT-23, CPT-21, CPT-15, CPT-31, and MW-12. The root-mean-square (rms) error between observed and calibrated values at these points was 3.2 feet which corresponds to a calibration error of 2.5 percent (water levels dropped approximately 130 feet from northeast to southwest across the model grid). A plot of measured vs. calibrated heads shows a random distribution of calibrated heads and is shown in Appendix D. Deviation of points from a straight line should be randomly distributed in computer simulations (Anderson and Woessner, 1992).

In solving the ground water flow equation, Bioplume II establishes the water table surface and calculates an overall hydraulic balance that accounts for the numerical difference between flux into and out of the system. The hydraulic mass balance for the calibrated model was excellent, with 99.95 percent of the water flux into and out of the system being numerically accounted for. Figure 5.3 shows the calibrated water table.

5.5.2 BTEX Plume Calibration

Model input parameters affecting the distribution and concentration of the simulated BTEX plume were modified so that initial model results closely matched dissolved-phase total BTEX concentrations observed in August 1993, and model predictions approximated dissolved-phase total BTEX concentrations observed in July 1994. Because LNAPL is present at the site, it was necessary to include 20 injection cells to simulate partitioning of BTEX compounds from the LNAPL into the ground water. The location of the injection cells is shown on Figure 5.1. Chemical analysis of LNAPL from MW-10 indicate that the LNAPL at the site is probably dominated by JP-4 jet fuel. LNAPL contamination is estimated to cover an area of approximately 225,000 square feet (Figure 4.1).

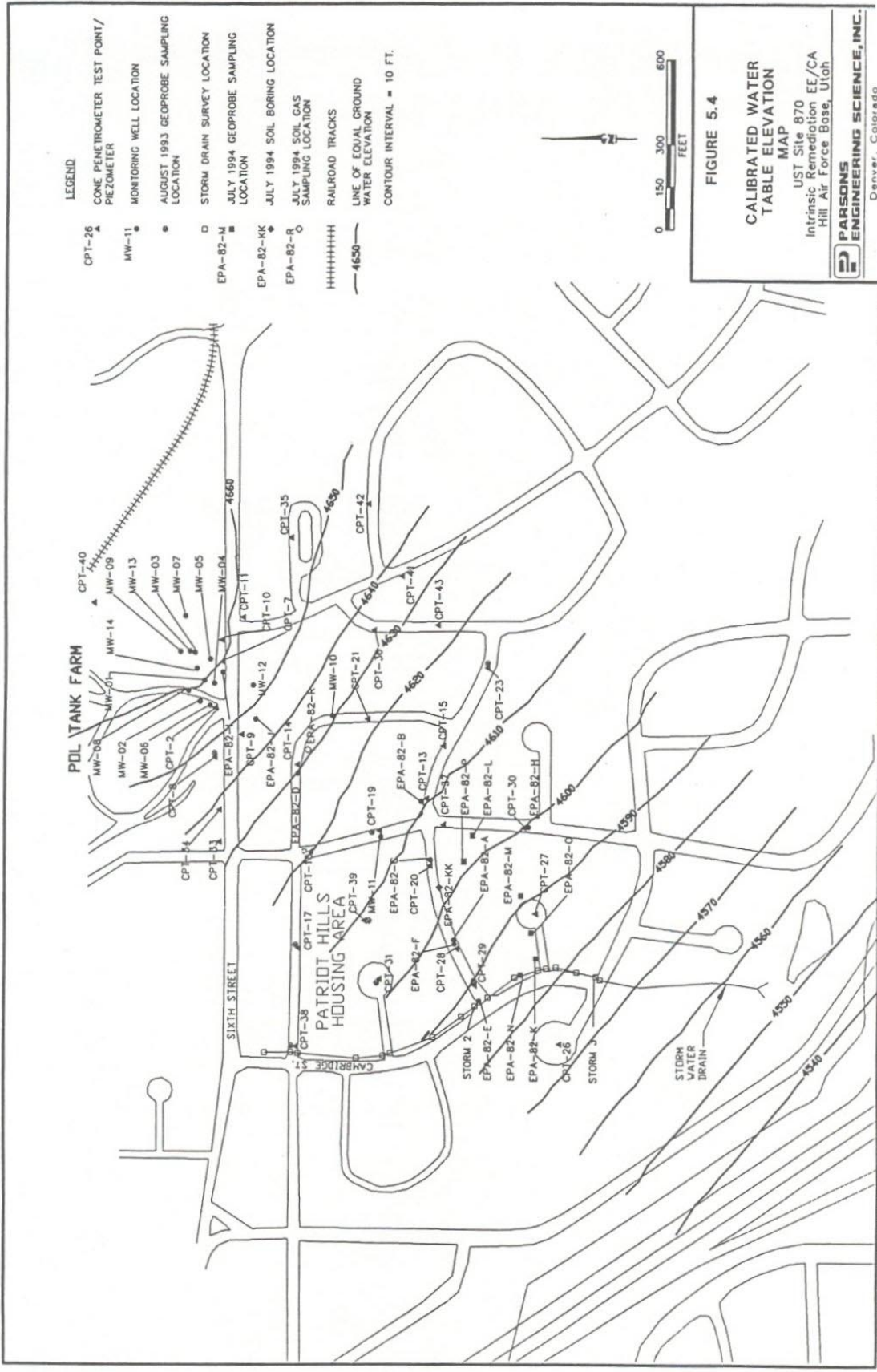

The injection rate of the cells was set at 5 cubic feet per day (cfd), a value low enough so that the ground water elevation calibration was not affected. Total BTEX injection concentrations were determined by varying the injection concentration in the various cells from 1 to 1,650 mg/L until the initial total BTEX plume generated by the model approximated the total BTEX plume observed in August 1993, and the model predictions approximated the change in dissolved-phase total BTEX concentrations that occurred between August 1993 and July 1994. Relatively high BTEX concentrations were injected in upgradient injection cells because of the influx of 34 mg/L of combined oxygen and ionic nitrate electron acceptor concentrations (5 mg/L DO and 10 mg/L nitrate as N) introduced at the upgradient constant-head cells. This high replenishment of available electron acceptors quickly degraded BTEX concentrations at the head of the plume as they flushed through the aquifer, which in turn required large injection concentrations of BTEX to maintain observed BTEX contours. By varying the injection well concentrations, the BTEX plume was calibrated reasonably well to the change in the total BTEX plume between August 1993 and July 1994 in terms of migration distance and BTEX concentrations directly under the LNAPL contamination.

5.6 SENSITIVITY ANALYSIS

The purpose of the sensitivity analysis is to determine the effect of varying model input parameters on model output. Based on the work of Rifai *et al.* (1988), the Bioplume II model is most sensitive to changes in the coefficient of reaeration, the coefficient of anaerobic decay, and the hydraulic conductivity of the media, and is less sensitive to changes in the retardation factor, porosity, and dispersivity. A first-order anaerobic decay coefficient was not used because nitrate was included in the original oxygen map to simulate anaerobic biodegradation at the site. Because the coefficient of anaerobic decay was set to zero, the sensitivity analysis was conducted by varying the hydraulic conductivity (and therefore transmissivity) and the coefficient of reaeration. Because of the potential for large dispersivity values at the site, a sensitivity analysis was also performed on this parameter.

To perform the sensitivity analyses, an individual run of the model was made with the same input as the calibrated model, except that one of the aforementioned parameters was varied. The models were run for 10 years so that the independent effect of each variable could be assessed. As a result, six sensitivity runs of the calibrated model were made, with the following variations:

- 1) Hydraulic conductivity uniformly increased by a factor of 5;
- 2) Hydraulic conductivity uniformly decreased by a factor of 0.2;

- 3) Longitudinal dispersivity increased to 100;
- 4) Longitudinal dispersivity decreased to 5.34;
- 5) Reaeration coefficient increased to 0.03 day^{-1} ; and
- 6) Reaeration coefficient decreased to 0.0003 day^{-1} .

The results of the sensitivity analyses are shown graphically in Figures 5.4, 5.5, and 5.6. These figures display the modeled BTEX concentrations versus distance along the centerline of the plume. This manner of displaying data is useful because the plume is narrow and maintains a constant plume migration direction parallel to the model grid. Furthermore, the figures allow easy visualization of the changes in BTEX concentration caused by varying model input parameters.

Uniformly increasing the hydraulic conductivity in the model by half an order of magnitude (model H1) drastically increased the migration rate and biodegradation rate of the plume (Figure 5.4). Plume migration and influx of fresh electron acceptors was so rapid that no appearance of BTEX concentrations was predicted by the model. This was caused by an abnormally high influx of electron acceptors in the highly conductive aquifer that immediately biodegraded existing and injected BTEX concentrations. In contrast, decreasing the hydraulic conductivity by a half-order of magnitude slowed plume migration, which in turn caused an increase in measured BTEX levels in the source area. Increased BTEX concentrations in the source area are caused by a reduction in the amount of electron acceptors being brought into contact with the plume from upgradient locations.

The effect of varying the coefficient of reaeration is shown in Figure 5.5. Loss of BTEX in ground water caused by increasing the reaeration coefficient from 0.003 day^{-1} to 0.03 day^{-1} was significant, and complete biodegradation of all existing and injected BTEX occurred instantaneously. By reducing the reaeration coefficient by an order of magnitude, a more modest change in the shape of the plume occurred. The downgradient end of the plume extended approximately 500 feet past its observed location.

FIGURE 5.5
 PLOT OF TOTAL BTEX VS DISTANCE ALONG PLUME
 CENTERLINE WITH VARYING HYDRAULIC CONDUCTIVITY
 UST SITE 870 INTRINSIC REMEDIATION EE/CA
 HILL AFB, UTAH

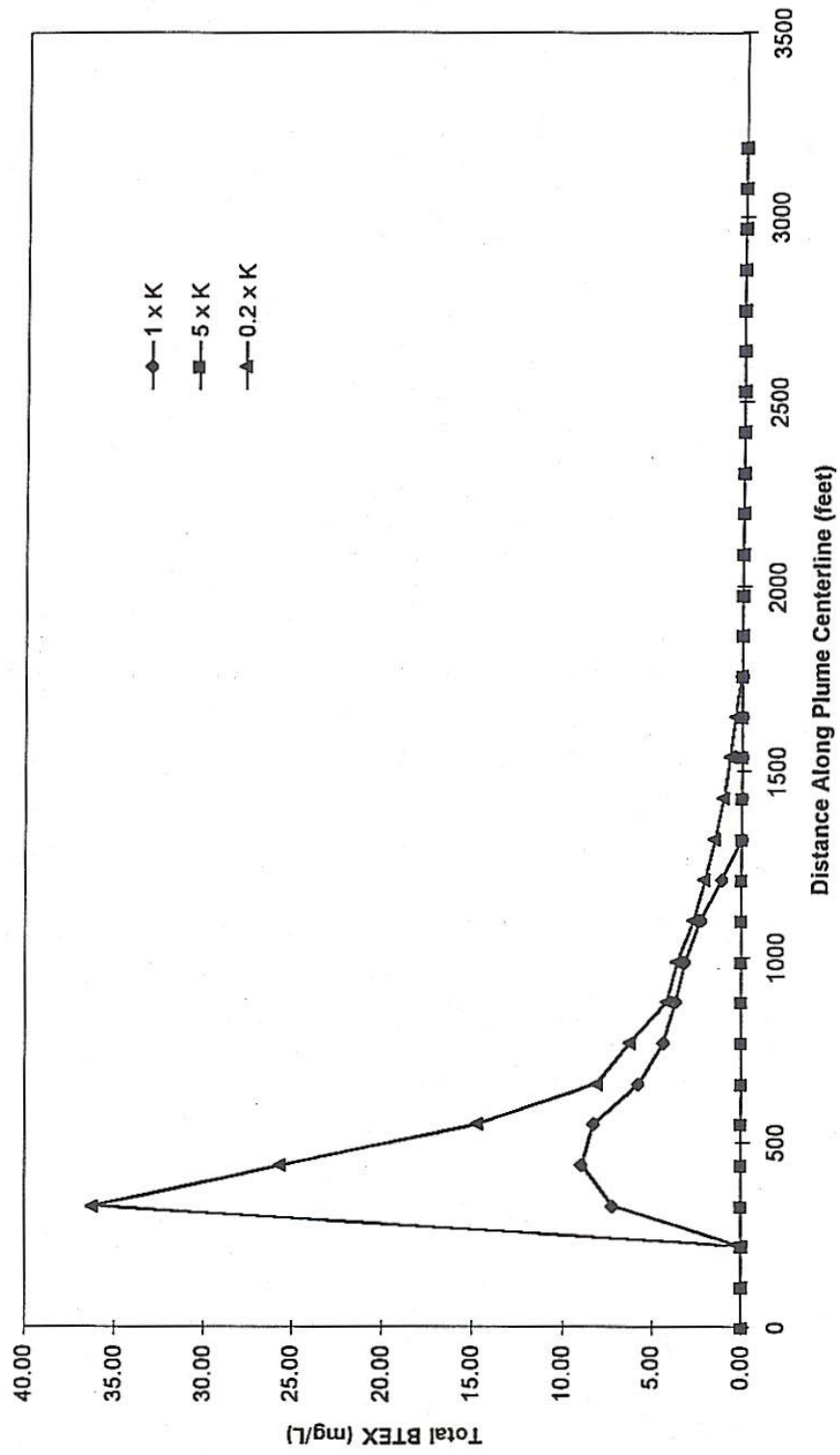

FIGURE 5.6
 PLOT OF TOTAL BTEX VS DISTANCE ALONG PLUME
 CENTERLINE WITH VARYING COEFFICIENT OF REAERATION
 UST SITE 870 INTRINSIC REMEDIATION EE/CA
 HILL AFB, UTAH

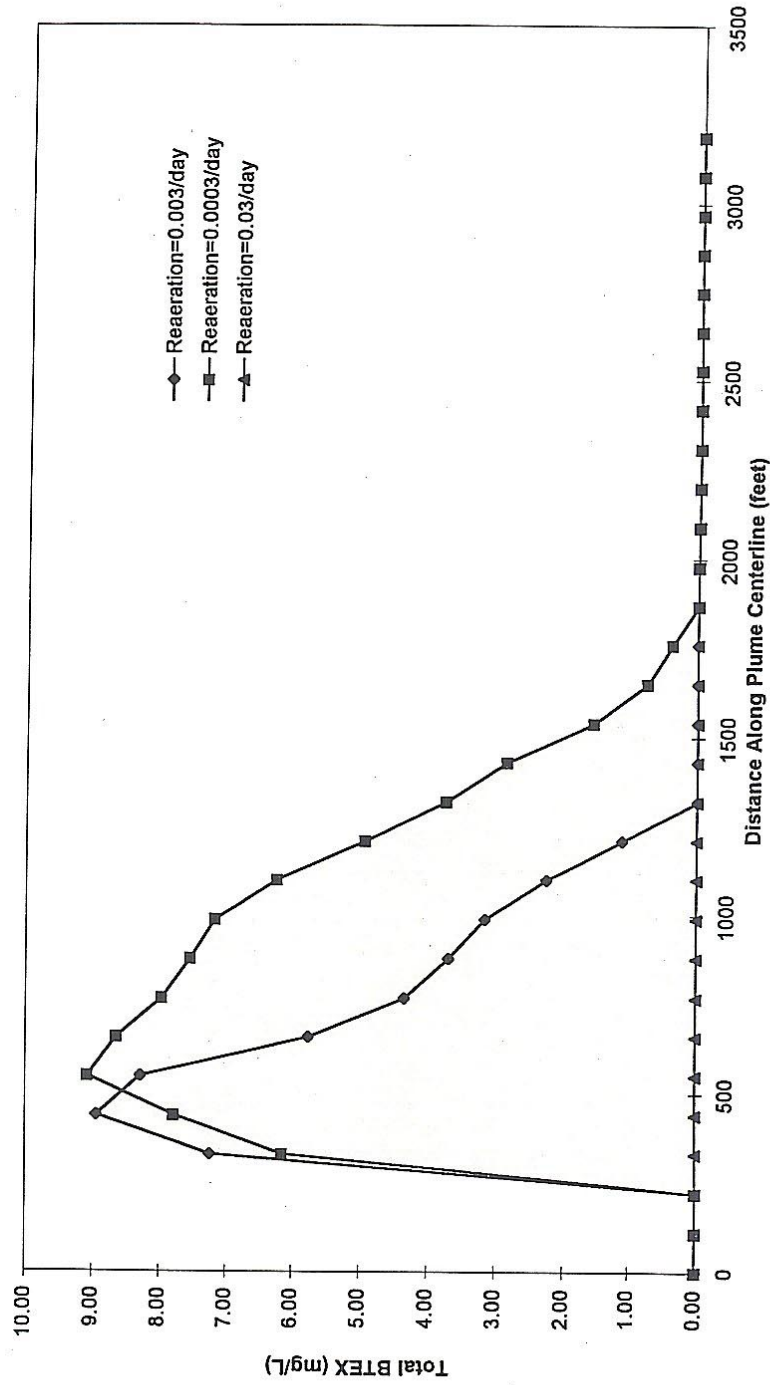

FIGURE 5.7
 PLOT OF TOTAL BTEX VS DISTANCE ALONG
 PLUME CENTERLINE WITH VARYING DISPERSIVITY
 UST SITE 870 INTRINSIC REMEDIATION EE/CA
 HILL AFB, UTAH

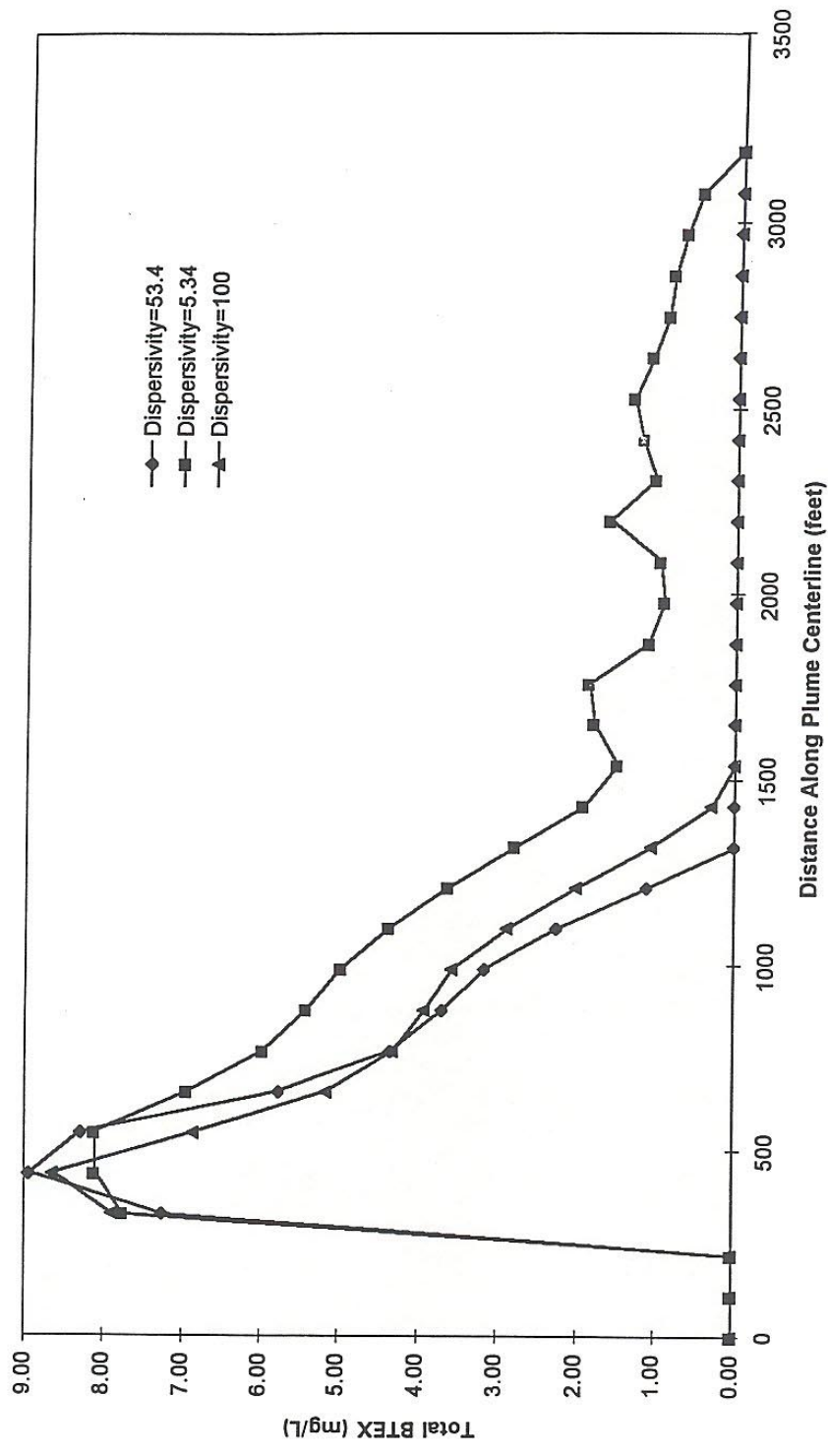

Figure 5.7 illustrates the effects of varying longitudinal dispersivity. Decreasing the dispersivity resulted in a larger migration distance for the BTEX plume. This occurs because lowering the dispersivity keeps the plume from spreading out into more electron acceptor-rich portions of the aquifer. Increasing the dispersivity resulted in faster dilution of BTEX in the source area; however, the migration distance of the BTEX was only slightly altered by increasing the dispersivity.

The results of the sensitivity analysis suggest that the calibrated model used for this report is reasonable. Increasing the coefficient of reaeration or the hydraulic conductivity greatly affects the predicted BTEX concentration and distribution. Lowering the values of these variables causes an abnormal lengthening of the plume to beyond reasonable distances based on observations made at the site between August 1993 and July 1994. The calibrated model appears to reasonably simulate the observed BTEX plume.

5.7 MODEL RESULTS

The Bioplume II[®] model was run under steady-state conditions with no LNAPL removal, 5-percent annual LNAPL removal, and 15-percent annual LNAPL removal until the plume reached steady-state equilibrium (no LNAPL removal) or until the plume disappeared (LNAPL removal scenarios). As previously mentioned, LNAPL contamination at the site is extensive. LNAPL reduction through source removal, in concert with natural attenuation can significantly reduce the longevity of the BTEX contamination at the site.

Although the results of each model run varied depending on the amount of LNAPL dissolution over time, two trends were consistently observed, including:

- 1) The plume shape in each simulation is elongated because of the rapid advective transport of BTEX contamination and rapid biodegradation of BTEX at the plume periphery. This is consistent with what was observed between August 1993 and July 1994 (Figures 4.4 and 4.5);

- 2) A BTEX partitioning threshold develops in the two models that simulate a reduction in the LNAPL source term. In both models the hydrocarbon plume disappears when the BTEX injection concentration is reduced to approximately 55 percent of its original value. This occurs because replenished electron acceptor concentrations greatly exceed the BTEX contamination introduced into the aquifer by the prescribed biodegradation ratio of DO and DO-equivalent nitrate to BTEX of 3.1:1

The following sections describe the results of each model scenario.

5.7.1 No Source Removal (Model Hill-A)

Model Hill-A simulated the migration and biodegradation of the BTEX plume assuming no LNAPL weathering or removal. Approximately 3,900 gm (39,000 mg or 390,000 µg) of dissolved-phase BTEX contamination existed at the start of modeling (T=0, based on data from August 1993). This estimate was calculated by Bioplume II, which summed all dissolved BTEX contamination over the Hill AFB model domain at time zero. Contaminant migration was rapid because of the high hydraulic conductivity and steep hydraulic gradient present at the site. The total BTEX plume thins in shape and stretches just past Cambridge Street after 1 year (Figure 5.8). The Bioplume II model predicted that the plume would reach steady-state equilibrium within 4 years. Figures 5.8 and 5.9 show the predicted total BTEX concentrations at years 1 and 10. The plume migrates in the expected southwest direction, and by 1 year, levels of greater than 1 µg/L of dissolved-phase BTEX are predicted to reach the vicinity of Cambridge Street in the Patriot Hills Housing complex. However, the stabilized plume (> 4 years) has slightly receded and only extends as far as the intersection of Cambridge Street and Adams Circle. The stabilized plume predicted by the model closely resembles the plume observed at the site in July 1994. Differences in modeled and actual plume shape are caused by physical, chemical, and biological variations within the shallow saturated zone that result from natural aquifer heterogeneity.

5.7.2 Five-Percent Annual Source Removal (Model Hill-B)

Model Hill-B simulated the migration and biodegradation of the BTEX plume assuming a 5-percent annual reduction in source BTEX concentrations caused by natural weathering processes and limited source removal by LNAPL skimming and bioventing. Model Hill-B is identical to model Hill-A with the exception of the 5-percent annual source removal term. Figures 5.9, 5.10, and 5.11 show the results of this model. The simulation time of the model was 25 years because

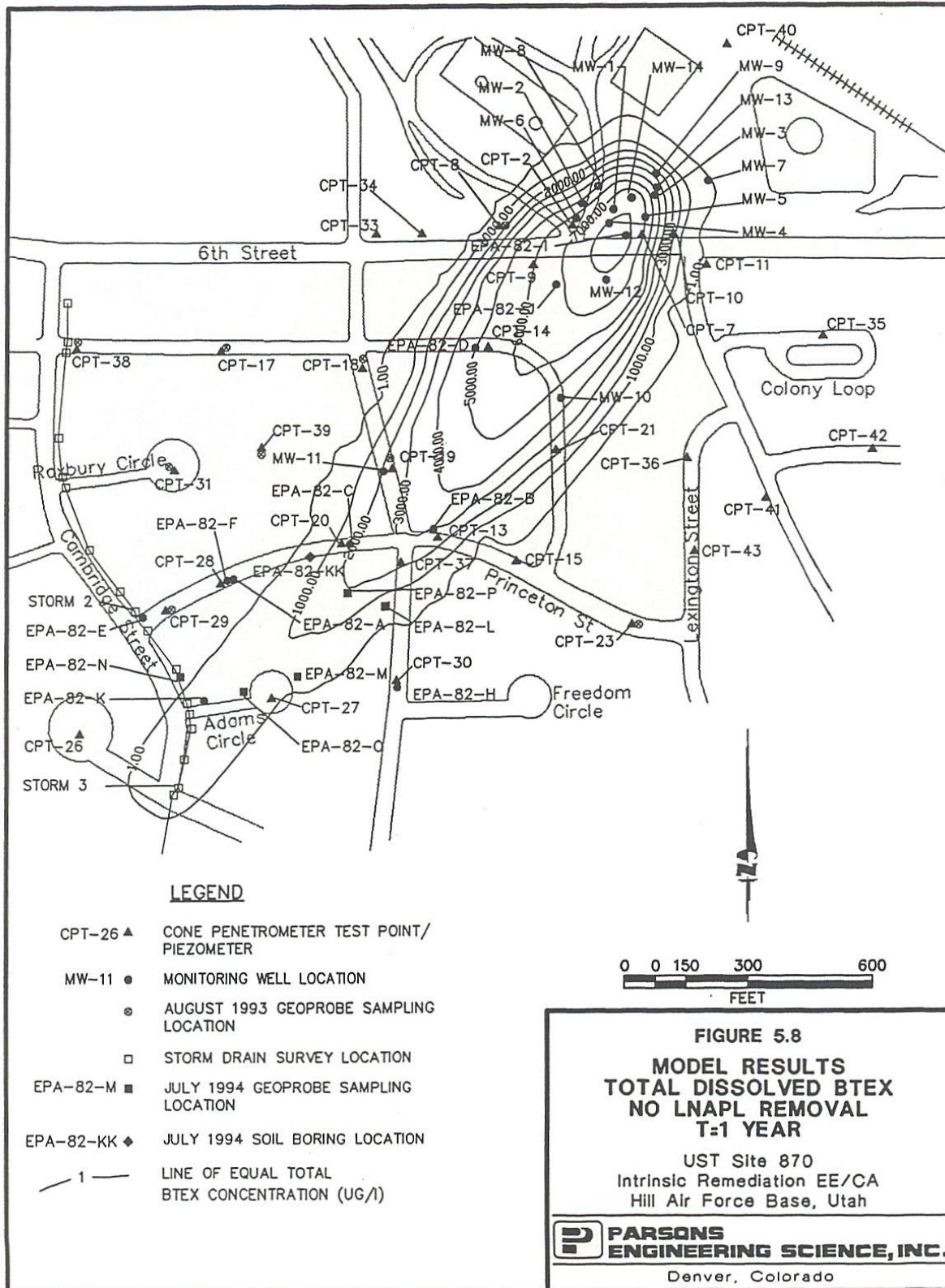

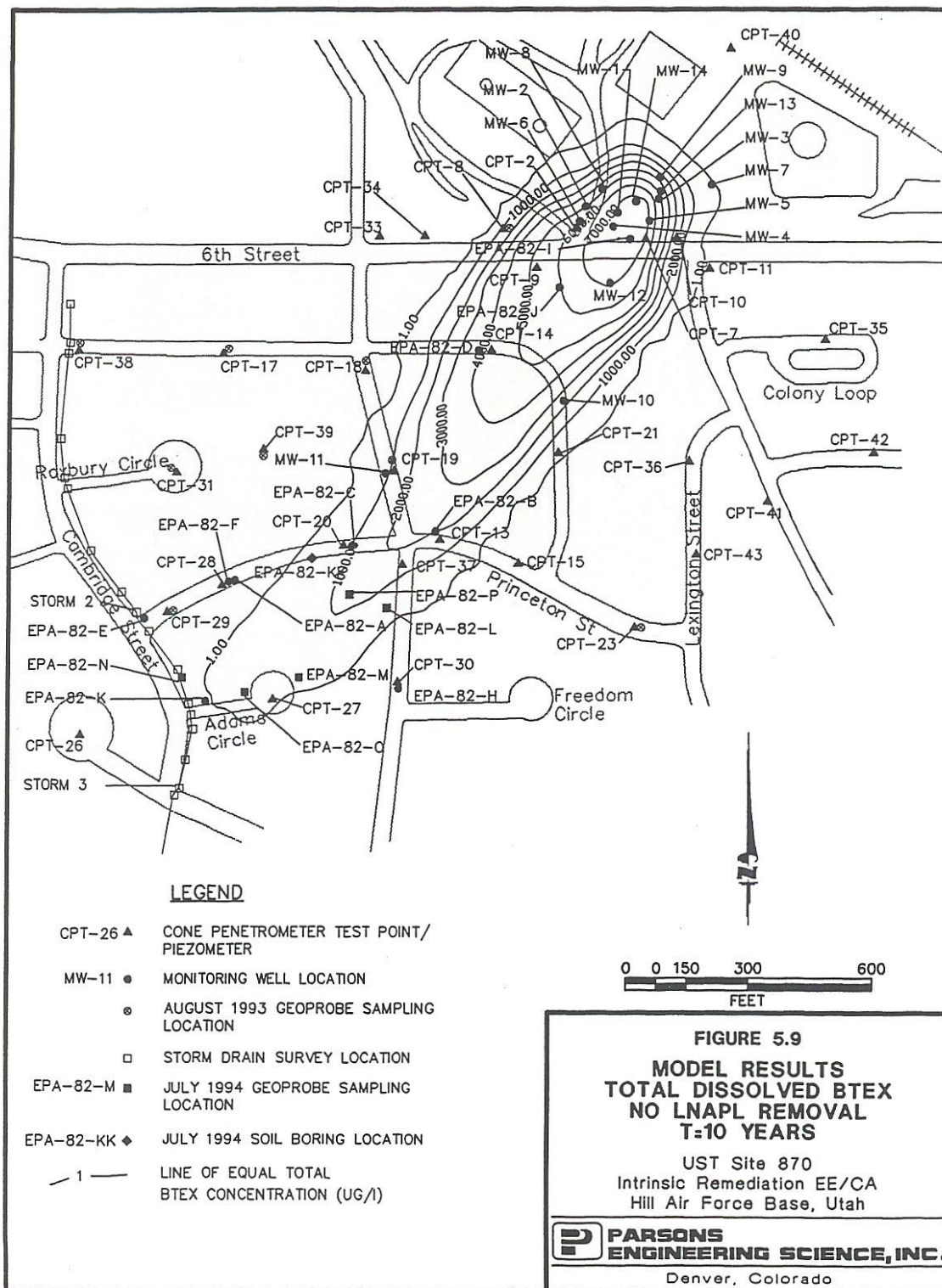

20 years were required before the LNAPL was theoretically reduced to 0 percent of its original partitioning strength. Despite the lengthy estimated period required to remove all the LNAPL contamination, BTEX disappeared in model simulations long before free-phase partitioning of BTEX from the LNAPL into the ground water ceased. The initial extent and concentration of BTEX contamination in years 1 and 2 were nearly identical to those predicted in model Hill-A. However, after 4 years the plume had noticeably receded at the periphery and the internal concentrations of BTEX were reduced by as much as 2 mg/L (2,000 µg/L). By year 7, the plume was approximately 10 percent of its original area, and the maximum concentration of BTEX was predicted to be only 300 µg/L in the source area. The reach of contamination at this point extends roughly 100 feet northwest of the intersection at Princeton Street and Liberty Road. Although BTEX partitioning was simulated for the first 19 years of the pumping period, dissolved-phase BTEX contamination was estimated to be completely degraded after 7 years. This situation is caused by the influx of electron acceptors by upgradient replenishment and reaeration that exceed the levels required to biodegrade the BTEX contamination injected into the 20 injection cells of the model grid.

5.7.3 Fifteen-Percent Annual Source Removal (Model Hill-C)

Model Hill-C simulated the migration and biodegradation of the BTEX plume assuming a 15-percent annual reduction in source BTEX concentrations caused by natural weathering processes and more active source removal by expanded LNAPL pumping and expanded bioventing. Model Hill-C is identical to model Hill-A with the exception of the 15-percent annual source removal term. Figures 5.13 and 5.14 show the results of this model for 1 and 3 years after the implementation of a 15-percent annual source removal technology. The initial 1-year prediction of plume migration suggests that the plume would extend as far as Cambridge Street at concentrations of 1 µg/L. By year 3 (Figure 5.14), the BTEX plume had undergone significant loss, including a complete reduction of BTEX contamination in the source area. By year 4, the plume had entirely disappeared. This complete plume disappearance at year 4 was caused by the injection loading rates of modeled BTEX to be reduced to 55 percent of the original loading rate, which was below the biodegradation capacity of the upgradient, influent electron acceptors and aquifer reaeration.

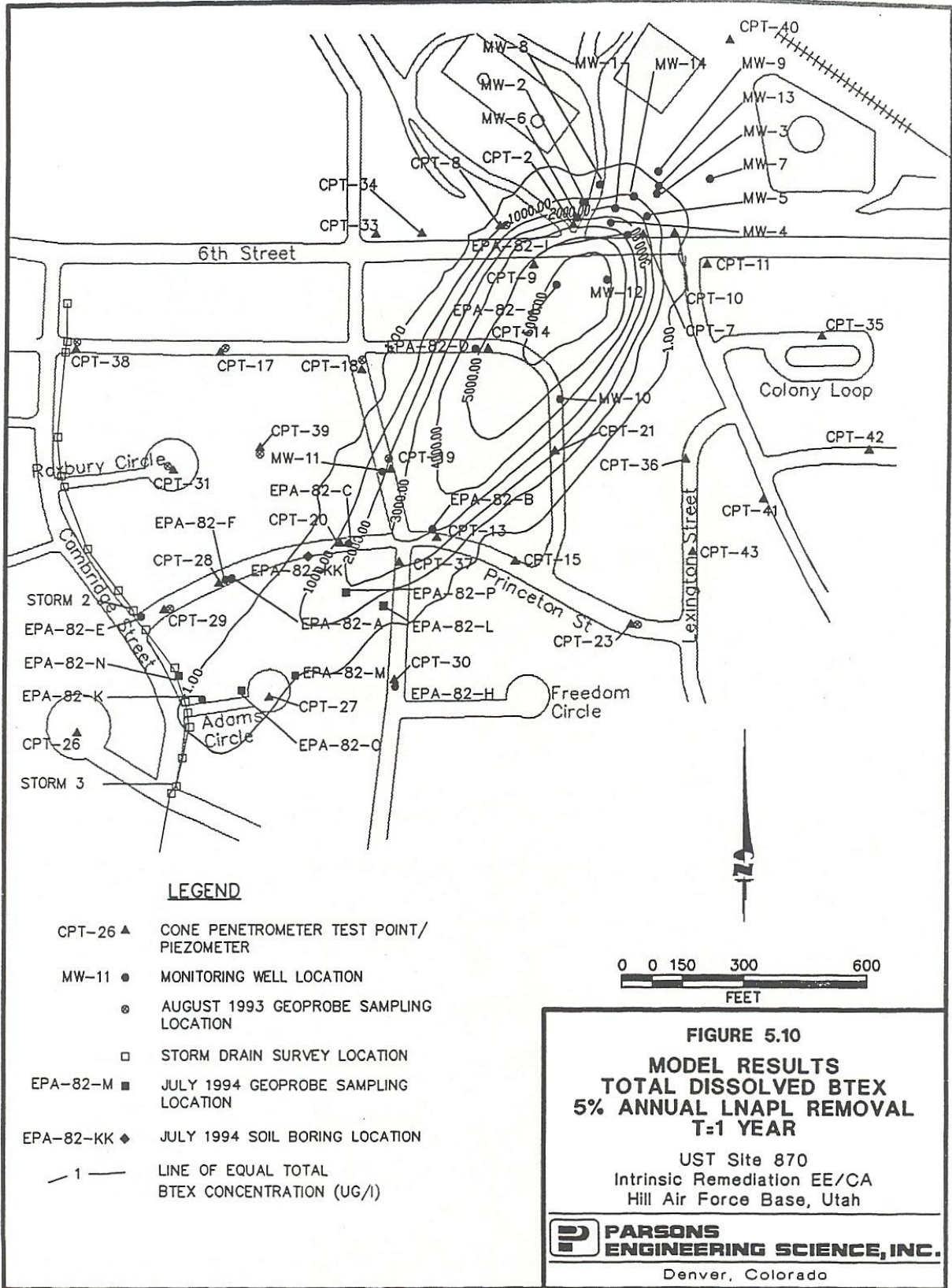

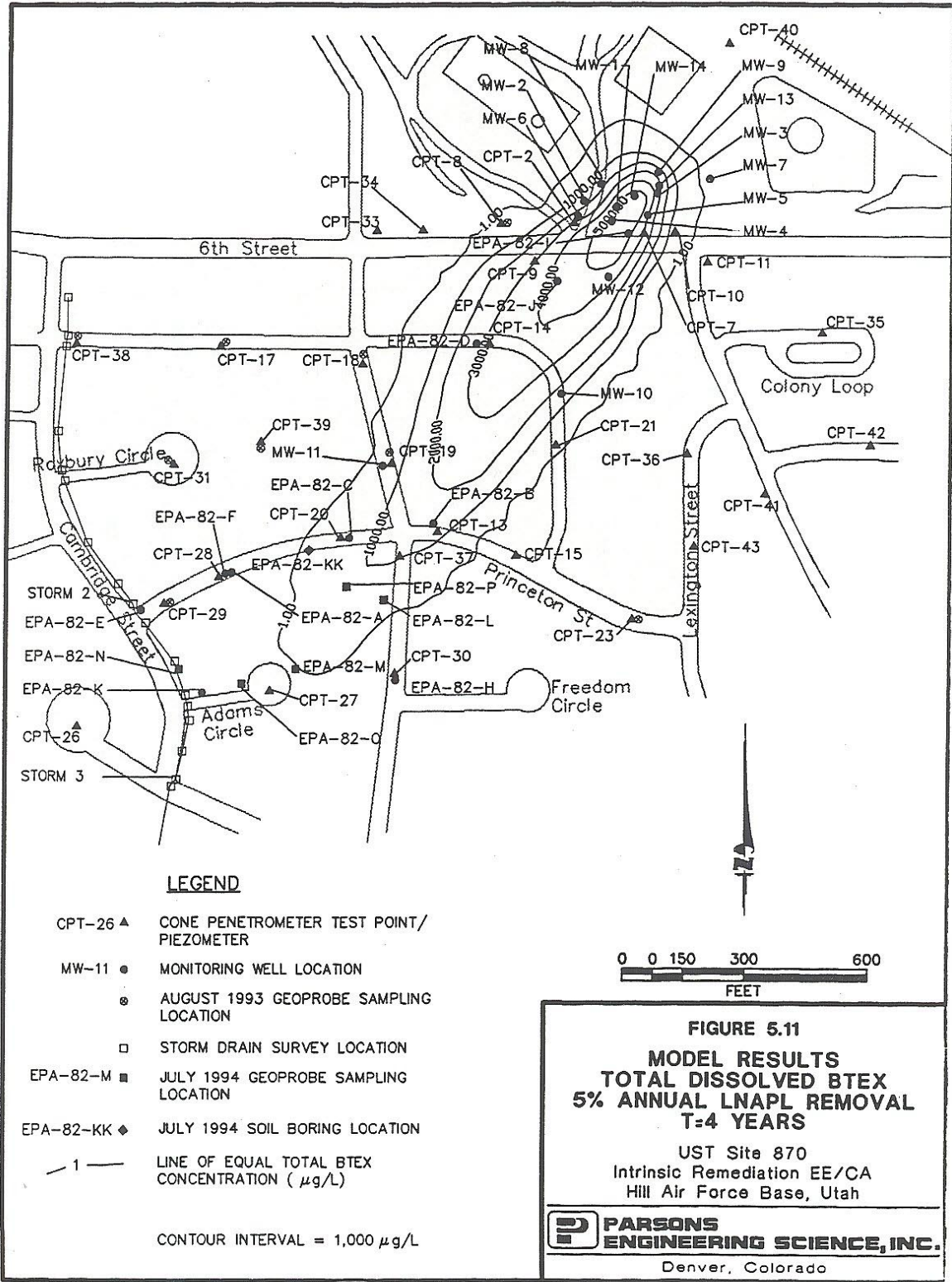

L:\45002

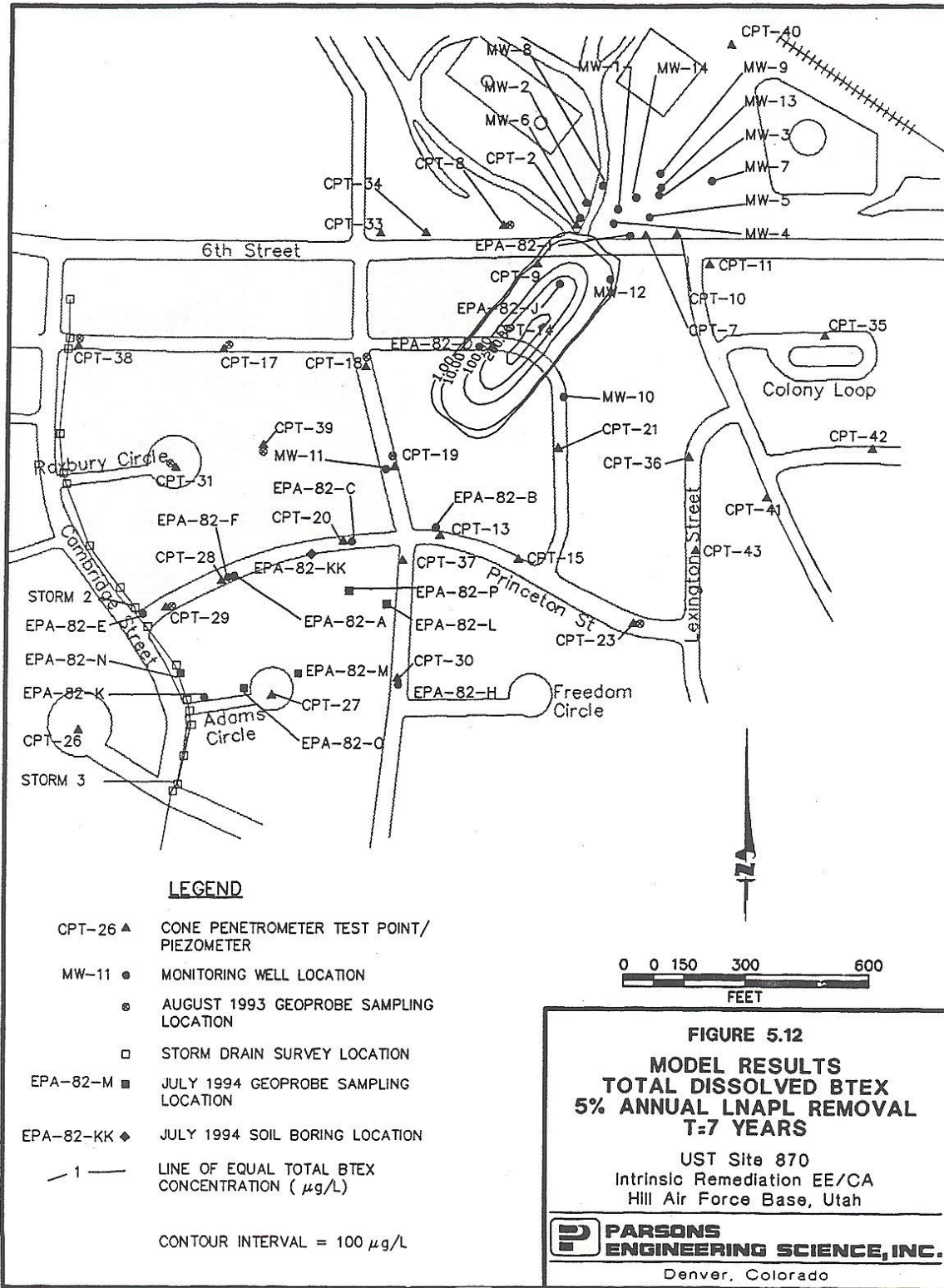

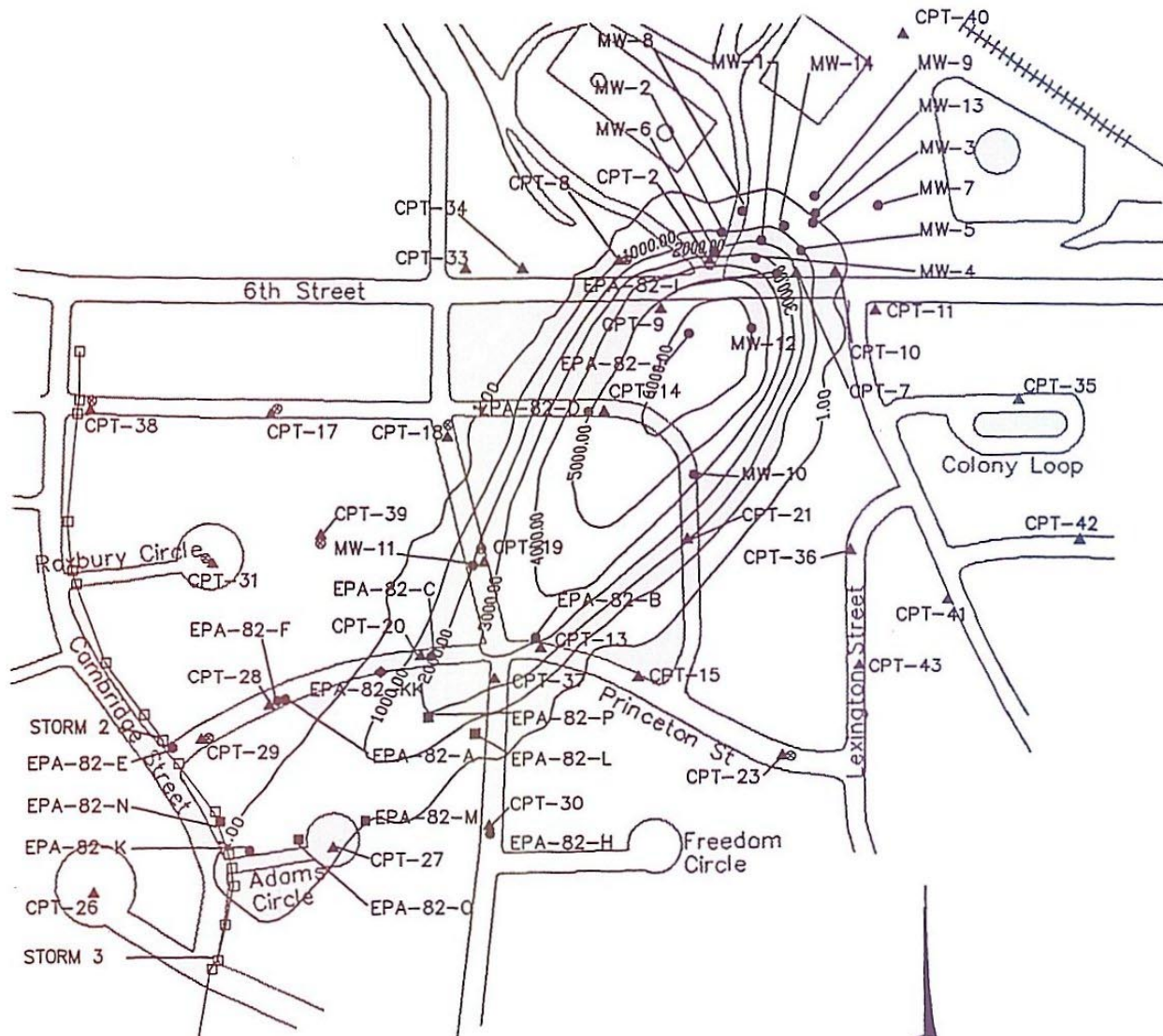

LEGEND

- CPT-26 ▲ CONE PENETROMETER TEST POINT/
PIEZOMETER
- MW-11 ● MONITORING WELL LOCATION
- AUGUST 1993 GEOPROBE SAMPLING
LOCATION
- STORM DRAIN SURVEY LOCATION
- EPA-82-M ■ JULY 1994 GEOPROBE SAMPLING
LOCATION
- EPA-82-KK ◆ JULY 1994 SOIL BORING LOCATION
- 1 — LINE OF EQUAL TOTAL BTEX
CONCENTRATION (μg/L)

CONTOUR INTERVAL = 1,000 μg/L

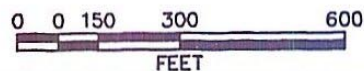
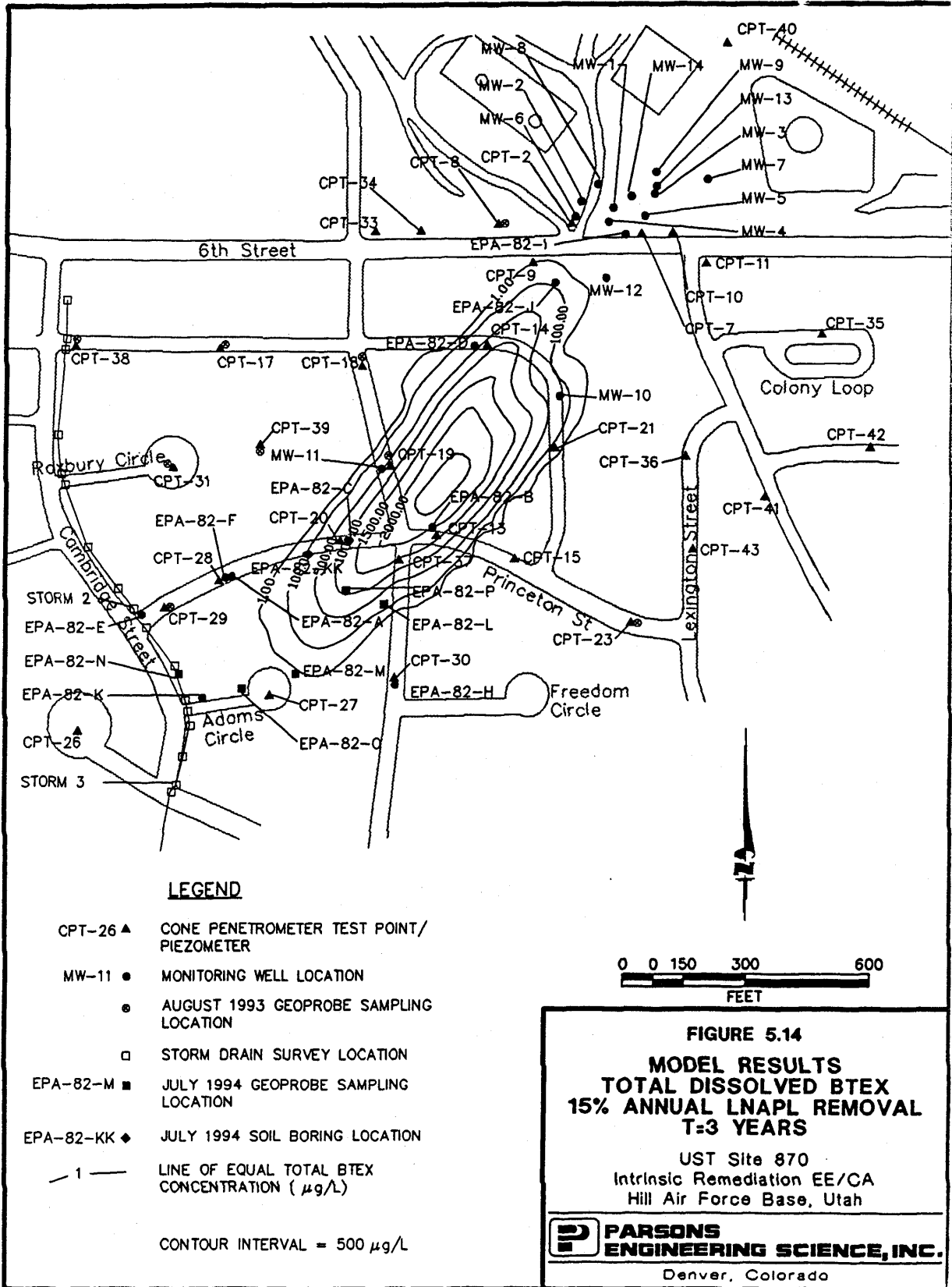

FIGURE 5.13
MODEL RESULTS
TOTAL DISSOLVED BTEX
15% ANNUAL LNAPL REMOVAL
T=1 YEAR

UST Site 870
Intrinsic Remediation EE/CA
Hill Air Force Base, Utah

PARSONS
ENGINEERING SCIENCE, INC

Denver, Colorado



5.9 CONCLUSIONS

Contaminant fate and transport at UST Site 870 was simulated using the finite-difference ground water model Bioplume II. Model results suggest that BTEX contamination may possibly migrate to Cambridge Street and the stormwater sewer running parallel to this street in all models. However, model simulations conducted during this project are extremely conservative for several reasons, including:

- 1) Aerobic respiration, denitrification, iron reduction, sulfanogenesis, and methanogenesis are all occurring at this site; however, only DO and nitrate are considered as electron acceptors during model simulations;
- 2) The stoichiometry used to determine the ratio between DO and nitrate-equivalent DO assumed that no microbial cell mass was produced during the reaction. As discussed in Section 4.3.2.1, this approach may be too conservative by a factor of three.
- 3) The highest DO concentration observed at the site was 6.3 mg/L. The highest DO concentration assumed during model simulations was 5.0 mg/L. In addition, the highest observed nitrate concentration observed at the site was 17 mg/L. The highest nitrate concentration assumed during model simulations was 10 mg/L. This nitrate concentration came only from upgradient, constant head cells; the majority of the area outside the plume was assumed to have nitrate concentrations of only 5 mg/L.
- 4) The lowest coefficient of retardation for benzene (1.29) was used for model simulations. Coefficient of retardation values for the other BTEX compounds range from 1.7 to 3.35. The use of the low coefficient of retardation tends to increase the distance traveled by the simulated BTEX plume, but provides a more accurate estimate of benzene transport.

The results of the Bioplume II modeling effort were used to help develop and compare ground water remedial options. This comparative analysis of remedial options is presented in Section 6.

SECTION 6

COMPARATIVE ANALYSIS OF REMEDIAL ALTERNATIVES

This section presents the development and comparative analysis of three ground water remedial alternatives for UST Site 870 at Hill AFB. The intent of this evaluation is to determine if intrinsic remediation is an appropriate and cost-effective remedial technology to consider when developing final remedial strategies for UST Site 870, especially when combined with other innovative and conventional remedial technologies.

Section 6.1 presents the evaluation criteria to be used to evaluate ground water remedial alternatives. Section 6.2 discusses the development of remedial alternatives to be considered as part of this demonstration project. Section 6.3 provides a brief description of each of these remedial alternatives. Section 6.4 provides a more detailed analysis of the remedial alternatives using the defined remedial alternative evaluation criteria. The results of this evaluation process are summarized in Section 6.5.

6.1 REMEDIAL ALTERNATIVE EVALUATION CRITERIA

The evaluation criteria used to identify the most appropriate remedial alternative for shallow ground water contamination at UST Site 870 were adapted from those recommended by the USEPA for selecting remedies for Superfund sites (OSWER Directive 9902.3). These criteria included (1) long-term effectiveness and permanence, (2) technical and administrative implementability, and (3) relative cost. The following sections briefly describe the scope and purpose of each evaluation criterion. This report does not include a complete discussion of applicable or relevant and appropriate requirements (ARARs) for the site. Rather, this report focuses on the potential use of intrinsic remediation and source reduction technologies to reduce BTEX concentrations within the shallow ground water to levels that pose no unacceptable risk to human health or the environment.

6.1.1 Long-Term Effectiveness and Permanence

Each remedial technology or remedial alternative (which can be a combination of remedial technologies such as intrinsic remediation and institutional controls) is analyzed to determine how effectively it will minimize ground water plume expansion so that ground water quality standards can be achieved at a downgradient POC. The expected technical effectiveness based on case histories from Hill AFB sites and other sites with similar conditions is also evaluated. The ability to minimize potential impacts to surrounding facilities and operations is considered. The ability of each remedial alternative to protect both current and potential future receptors from potential risks associated with site-related contamination in shallow ground water is qualitatively assessed by conservatively estimating if a potential exposure pathway involving ground water could be completed, either now or in the future. This evaluation criterion also included permanence and the ability to reduce contaminant mass, toxicity, and volume. Time to implementation and time until protection is achieved is described. Long-term reliability for providing continued protection, including an assessment of potential for failure of the technology and the potential threats resulting from such a failure, is also presented.

6.1.2 Implementability

The technical implementation of each remedial technology or remedial alternative was evaluated in terms of technical feasibility and availability. Potential shortcomings and difficulties in construction, operations, and monitoring are presented and weighed against perceived benefits. Requirements for any post-implementation site control, such as long-term monitoring and land use restrictions, are described. Details on administrative feasibility in terms of the likelihood of public acceptance and the ability to obtain necessary approvals is discussed.

6.1.3 Cost

The total cost (present worth) of each remedial alternative was estimated for relative comparison. An estimate of capital costs, and operating and post-implementation costs for site monitoring and land use controls is included. An annual inflation factor of 5 percent was applied in calculating the present value of operation, maintenance, and monitoring costs.

6.2 FACTORS INFLUENCING ALTERNATIVES DEVELOPMENT

Several factors were considered during the identification and screening of remedial technologies for addressing shallow ground water contamination at UST Site 870. Factors considered included the objectives of the natural attenuation demonstration program; contaminant, ground water and soil properties; present and future land use; and potential exposure pathways. This section briefly describes each of these factors and how they were used to narrow the list of potentially applicable remedial technologies to the final remedial alternatives considered for UST Site 870.

6.2.1 Program Objectives

The intent of the Natural Attenuation (Intrinsic Remediation) Demonstration Program sponsored by AFCEE is to develop a systematic process for scientifically investigating and documenting naturally occurring subsurface attenuation processes that can be factored into overall site remediation plans. The objective of this program and the specific UST Site 870 study is to provide solid evidence of intrinsic remediation of dissolved-phase fuel hydrocarbon so that this information can be used to develop an effective ground water remediation strategy. A secondary goal of this multi-site initiative is to provide a series of regional case studies which demonstrate that natural processes of contaminant degradation can often reduce contaminant concentrations in ground water to below acceptable cleanup standards before completion of potential exposure pathways.

Because the objective of this program is to study natural processes in the saturated zone rather than in all contaminated media (e.g., unsaturated soil, or soil gas), technologies have been evaluated based on their potential impact on shallow ground water and phreatic soils. Technologies that can reduce vadose zone contamination and partitioning of contaminants into ground water have also been evaluated. Many of the source removal technologies evaluated in this section will also reduce soil and soil gas contamination, but it is important to emphasize that the remedial alternatives developed in this document are not intended to remediate all contaminated media. Additional program objectives set forth by AFCEE include cost-effectiveness and minimization of waste. Technologies that may meet these criteria include institutional controls, soil vapor extraction, bioventing, mobile LNAPL removal, biosparging, ground water extraction and treatment (air stripping), and intrinsic remediation. Soil excavation, slurry walls, sheet piling, carbon adsorption, *ex situ* biological or chemical treatment, and onsite/offsite disposal are not attractive technology candidates for this site.

6.2.2 Contaminant Properties

The site-related contaminants targeted as part of this demonstration at UST Site 870 are the BTEX compounds. The source of this contamination is weathered JP-4 jet fuel present as residual LNAPL in capillary fringe soil and as mobile LNAPL floating on the ground water surface within the source area of UST Site 870. The physiochemical characteristics of both JP-4 and the individual BTEX compounds will greatly influence the effectiveness and selection of a remedial technology.

Petroleum hydrocarbon mixtures, such as JP-4 jet fuel, are comprised of over 300 compounds with different physiochemical characteristics. JP-4 is classified as a LNAPL with a liquid density of approximately 0.75 grams per milliliter (g/ml) at 20°C. Many compounds within JP-4 sorb very well to soil and are concentrated in the capillary fringe because the mixture is less dense than water. JP-4 is slightly soluble in water, with a maximum solubility of approximately 300 mg/L. JP-4 is also a primary substrate for biological metabolism. Simultaneous biodegradation of aliphatic, aromatic, and alicyclic hydrocarbons has been observed. In fact, mineralization rates of hydrocarbons in mixtures, such as JP-4, may be faster than mineralization of the individual constituents as a result of co-metabolic pathways (Jamison *et al.*, 1976; Perry, 1984).

The BTEX compounds are generally volatile, highly soluble in water, and adsorb less strongly to soil. These characteristics allow the BTEX compounds to leach more rapidly from contaminated soil into ground water and migrate as dissolved-phase contamination (Lyman *et al.*, 1992). All of the BTEX compounds are highly amenable to *in situ* degradation by both biotic and abiotic mechanisms.

Benzene is very volatile, with a vapor pressure of 76 millimeters of mercury (mm Hg) at 20°C and a Henry's Law Constant of approximately 0.0054 atmosphere-cubic meter/mole (atm-m³/mol) at 25°C (Hine and Mookerjee, 1975; Jury *et al.*, 1984). The solubility of benzene in water at 20°C has been reported to be 1,780 mg/L (Verschueren, 1983). Benzene is normally biodegraded to carbon dioxide with catechol as a short-lived intermediate (Hopper, 1978; Ribbons and Eaton, 1992).

Toluene is also volatile, with a vapor pressure of 22 mm Hg at 20°C and a Henry's Law Constant of about 0.0067 atm-m³/mol at 25°C (Pankow and Rosen, 1988; Hine and Mookerjee, 1975). Toluene sorbs more readily to soil media relative to benzene, but is still very mobile. The solubility of toluene in water at 20°C is approximately 515 mg/L at 20°C

(Verschueren, 1983). Toluene has been shown to degrade to pyruvate, caetaldehyde, and completely to carbon dioxide via the intermediate catechol (Hopper, 1978; Wilson *et al.*, 1986; Ribbons and Eaton, 1992).

Ethylbenzene has a vapor pressure of 7 mm Hg at 20°C and a Henry's Law Constant of 0.0066 atm-m³/mol (Pankow and Rosen, 1988; Valsaraj, 1988). Ethylbenzene sorbs more strongly to soils than benzene but less strongly than toluene (Abdul *et al.*, 1987). Ethylbenzene is also less soluble than benzene and toluene in water at 152 mg/L at 20°C (Verschueren, 1983; Miller *et al.*, 1985). Ethylbenzene ultimately degrades to carbon dioxide via its intermediate 3-ethylcatechol (Hopper, 1978; Ribbons and Eaton, 1992).

The three xylene isomers have vapor pressures ranging from 7 to 9 mm Hg at 20°C and Henry's Law Constants of between 0.005 and 0.007 atm-m³/mol at 25°C (Mackay and Wolkoff, 1973; Hine and Mookerjee, 1975; Pankow and Rosen, 1988). Of all of the BTEX compounds, xylenes sorb most strongly to soil, but still can leach from soil into the ground water (Abdul *et al.*, 1987). Xylenes have water solubilities of 152 to 160 mg/L at 20°C (Bohon and Claussen, 1951; Mackay and Shiu, 1981; Isnard and Lambert, 1988). Xylenes can degrade to carbon dioxide via pyruvate carbonyl intermediates (Hopper, 1978; Ribbons and Eaton, 1992).

Based on these physiochemical characteristics, intrinsic remediation, soil vapor extraction, bioventing, biosparging, ground water extraction, and air stripping technologies could all be effective at destroying, collecting, and treating BTEX contaminants at UST Site 870.

6.2.3 Site-Specific Conditions

Two general categories of site-specific characteristics were considered in identifying remedial technologies to comparatively evaluate as part of this demonstration project. The first category considered was physical characteristics such as ground water depth, gradient, and flow direction, and soil type, and their influence on the types of remedial technologies most appropriate for the site. The second category involved assumptions about future land use and potential exposure pathways. Each of these site-specific characteristics have influenced the selection of remedial alternatives included in the comparative evaluation.

6.2.3.1 Ground Water and Soil Characteristics

Site geology and hydrogeology will have a profound effect on the transport of contaminants and the effectiveness and scope of required remedial technologies at a site. Hydraulic conductivity is perhaps the most important aquifer parameter governing ground water flow and contaminant transport in the subsurface. The velocity of the ground water and dissolved-phase contamination is directly related to the hydraulic conductivity of the saturated zone. Rising-head slug tests completed at UST Site 870 indicate a relatively high hydraulic conductivity within and downgradient of the source area and dissolved-phase BTEX plume. Estimated values ranged from 1.67×10^{-2} to 8.31×10^{-3} cm/s. These high values are characteristic of sandy materials (see Sections 4 and 5 of this report). The high hydraulic conductivity of shallow sediments at this site directly influences the fate and transport of contaminants. The shallow ground water plume has migrated rapidly, increasing the areal extent of contamination (i.e., plume expansion) but decreasing the average concentration within the aquifer via dilution and increased biodegradation.

Although high hydraulic conductivity can result in plume expansion and migration, this same characteristic will also enhance the effectiveness of other remedial technologies, such as ground water extraction, biosparging, and intrinsic remediation. For example, it should be less expensive and time-consuming to capture and treat the contaminant plume using a network of extraction wells in areas of high hydraulic conductivity than to implement this technology in aquifers with low hydraulic conductivity. Contaminant recovery may also be maximized when contaminants are not significantly sorbed and retarded by phreatic soil. The relatively low TOC content of Hill AFB aquifer materials (<0.094 percent) should tend to minimize sorption and increase the mobility of all BTEX compounds. The effectiveness of biosparging may also be increased in highly conductive aquifers because of reduced entry pressures and increased sparging well radius of influence. Greater hydraulic conductivity also increases the amount of contaminant mass traveling through the biosparging network. The DO introduced by biosparging can also be utilized effectively to aerobically degrade the dissolved contaminant mass.

The rapid movement of contaminants within the subsurface away from the source will also increase the effectiveness of natural biodegradation processes by distributing the contaminant mass into areas enriched with electron acceptors. To satisfy the requirements of indigenous microbial activity and intrinsic remediation, the aquifer must provide an adequate and available carbon or energy source, electron acceptors, essential nutrients, proper ranges of pH, temperature, alkalinity, salinity, and redox potential.

Data collected as part of the field work phase of this demonstration project and described in Sections 3 and 4 of this document, indicate that UST Site 870 is characterized by an adequate and available carbon/energy source, electron acceptors, and essential nutrients to support measurable biodegradation of JP-4 contamination by indigenous microorganisms. Both DO and nitrate represent significant sources of electron acceptor capacity for the biodegradation of BTEX compounds in ground water at the site. Further, because fuel-hydrocarbon-degrading microorganisms have been known to thrive under a wide range of temperature and pH conditions (Freeze and Cherry, 1979), the physical and chemical conditions of the ground water and phreatic soil at UST Site 870 are not likely to inhibit microorganism growth.

Fuel hydrocarbon-degrading microorganisms are ubiquitous, and as many as 28 hydrocarbon-degrading isolates (bacteria and fungi) have been discovered in different soil environments (Davies and Westlake, 1977; Jones and Eddington, 1968). Indigenous microorganisms have a distinct advantage over microorganisms injected into the subsurface to enhance biodegradation as indigenous microorganisms are well adapted to the physical and chemical conditions of the subsurface in which they reside (Goldestein *et al.*, 1985). Microbe addition was not considered a viable remedial technology for UST Site 870.

6.2.3.2 Potential Exposure Pathways

An exposure assessment identifies the potential human and ecological receptors that could potentially come into contact with site-related contamination and the pathways through which these receptors might be exposed. To have a complete exposure pathway, there must be a source of contamination, a potential mechanism(s) of release, a pathway of transport to an exposure point, an exposure point, and a receptor. If any of these elements do not exist, the exposure pathway is considered incomplete, and receptors cannot come into contact with site-related contamination. Evaluation of the potential long-term effectiveness of any remedial technology or remedial alternative as part of this demonstration project includes determining if the approach will be sufficient and adequate to minimize plume expansion so that potential exposure pathways involving shallow ground water are incomplete.

Assumptions about current and future land use at a site form the basis for identifying potential receptors, potential exposure pathways, reasonable exposure scenarios, and appropriate remediation goals. USEPA (1991) advises that the land use associated with the highest (most conservative) potential level of exposure and risk that can reasonably be

expected to occur should be used to guide the identification of potential exposure pathways and to determine the level to which the site must be remediated. The source area consists of an industrial fuel storage and office facilities associated with mission support services. Warehouses, offices, and other large structures are located to the east and west of UST Site 870. A portion of the Patriot Hills Base Housing Area is located to the south and southwest of the source area. The ground water plume originating from UST Site 870 is migrating to the southwest, and has impacted shallow ground water underlying this residential area. Hill AFB elementary school is located immediately southwest of the housing area on the base's southwestern property boundary. Thus, the current land use within and downgradient of the contaminant plume is both industrial and residential.

Under reasonable current land use assumptions, potential receptors include both worker and residential populations. It is unlikely that workers could be exposed to site-related contamination in phreatic soils or shallow ground water unless this material was removed during future construction, excavations or remedial activities. Utility workers could be exposed to shallow ground water contamination if the plume migrates to and discharges into the storm drain located along Cambridge Street. Shallow ground water is not currently used to meet industrial demands at Hill AFB. All onbase water demands are met by deep supply wells and/or from water piped in from the nearby Weber Basin Water Conservancy District. Exposure pathways involving other environmental media such as shallow soils and soil gas in the source area were not considered as part of this project, but should be considered in overall site remediation decisions.

Because of the depth of ground water (>5 feet), current residents should not be exposed to site-related contamination in ground water and phreatic soil under normal exposure conditions appropriate for the site. The most conservative exposure assumption involving ground water would involve uncontrolled or domestic use of ground water as a potable water supply. Although this exposure scenario can be an important consideration in deciding whether or not to take action at a site, it is not reasonable under current land use conditions. As noted previously, shallow ground water is not used to meet domestic potable water demands at Hill AFB at this time. Hill AFB officials could apply land use restrictions or institutional controls in the residential area to prevent residential use of ground water. It is possible that residents could be directly exposed to shallow ground water contamination at the storm drain located along Cambridge Street as ground water may surface at this location. Potential current exposure pathways involving other environmental media such as soil gas beneath residential units were not considered as part of this demonstration. Other studies conducted at this site

have addressed the potential impact of soil gas on residential areas and have determined that these pathways are incomplete.

Assumptions about hypothetical future land uses must also be made to ensure that the remedial technology or alternative considered for shallow ground water at the site is adequate and sufficient to provide long-term protection. No changes in land use are anticipated in the foreseeable future. Use of the residential land use assumption is the most conservative (health-protective). Thus, potential future receptors include both worker and residential populations. The potential future exposure pathways involving workers are identical to those under current conditions provided shallow ground water is not used to meet industrial water demands. The potential future exposure pathways involving residents will also be identical to current conditions if Hill AFB can effectively restrict shallow ground water use in all areas potentially affected by contamination from UST Site 870. In summary, the use of the intrinsic remediation technology at this site will require that the source area be maintained as industrial property and that restrictions on ground water use be enforced in areas downgradient of UST Site 870 to the Cambridge Street stormwater drain. If source removal technologies such as soil vapor extraction, bioventing, mobile LNAPL recovery, biosparging, or ground water pump and treat are implemented, or expanded, they will also impact the short- and long-term land use options and will require some level of institutional control during and following remediation.

6.2.3.3 Remediation Goals for Shallow Ground Water

The stormwater sewer located along Cambridge Street has been identified as the most likely point of exposure for migrating contamination to impact human or ecological receptors. Migration to and discharge of contaminated shallow ground water into the stormwater system could complete an exposure pathway to human or ecological receptors via dermal contact or possible ingestion. The exceeding of Federal MCLs in the stormwater sewer near the intersection of Cambridge Street and Yorktown Street [proposed long-term monitoring (LTM) point], would trigger contingency sampling downgradient of the intersection at the outfall of the stormwater sewer near Pond 5. The stormwater sewer outfall into Pond 5 is an accessible and well-defined location for monitoring and for demonstrating compliance with protective ground water quality standards (Federal MCLs).

This remedial strategy would be consistent with remediation requirements set forth by the State of Utah. The State recognizes that compliance with promulgated, single-point

remediation goals is not necessary if site-related contamination does not pose a threat to human health or the environment (i.e., the exposure pathway is incomplete). Thus, the magnitude of required remediation in areas that can and will be placed under institutional control is different from the remediation that is required in areas that may be available for unrestricted use. This means that viable remedial alternatives, which includes long-term restrictions on shallow ground water use, must be able to achieve concentrations that minimize plume migration and expansion and potential human risk associated with ground water contact. The remediation goal for shallow ground water impacting the Cambridge Street stormwater drain is attainment of federal MCLs for each of the BTEX compounds, as listed in Table 6.1. Although it is unlikely that stormwater would be ingested by humans, this level of long-term protection is appropriate for a residential area.

TABLE 6.1
POINT-OF-COMPLIANCE REMEDIATION GOALS
UST SITE 870 INTRINSIC REMEDIATION EE/CA
HILL AFB, UTAH

Compound	Federal MCLs (µg/L)
Benzene	5
Toluene	1,000
Ethylbenzene	700
Total Xylenes	10,000

In summary, available data indicate that no potential exposure pathway involving shallow ground water is complete under current conditions, with the exception of soil gas emanating from the ground water to within 4 feet of the surface. The exposure route for soil gas was identified in a vapor exposure assessment performed in other site characterization studies (Gemperline, written communication, 1995). Although an exposure pathway to the surface is completed from BTEX contamination volatilizing from ground water, human risk was calculated to be inconsequential. Other than soil gas, no potential exposure pathway involving shallow ground water will be complete under future land use assumptions provided use of ground water as a potable or industrial source of water is prohibited by institutional controls within and downgradient of the source area to the Cambridge Street stormwater sewer. Thus,

institutional controls are likely to be a necessary component of any ground water remediation strategy for this site. The required duration of these institutional controls may vary depending on the effectiveness of any remedial technology at reducing contaminant mass and concentrations in the ground water. If Federal MCLs are exceeded in the Cambridge Street stormwater discharge, remediation of stormwater will be required to prevent pathway completion.

6.2.4 Summary of Remedial Technology Screening

Several remedial technologies were identified and screened for use in reducing the source of BTEX and for treating the shallow ground water at UST Site 870. Table 6.2 identifies the initial remedial technologies considered for this demonstration and those retained for more detailed analysis. Screening was conducted systematically by considering the objectives of the AFCEE intrinsic remediation demonstration, the physiochemical properties BTEX compounds, and other site-specific characteristics such as hydrology, land use assumptions, potential exposure pathways, and appropriate remediation goals. All of these factors will

TABLE 6.2
INITIAL TECHNICAL IMPLEMENTABILITY SCREENING OF
TECHNOLOGIES AND PROCESS OPTIONS FOR GROUND WATER REMEDIATION
UST SITE 870 INTRINSIC REMEDIATION EE/CA
HILL AFB, UTAH

General Response Action	Technology Type	Process Option	Implementability	Retain
Long-Term Monitoring	Periodic Ground Water Monitoring	Confirmation Wells	Many existing wells are available to confirm the progress of remediation.	Yes
		Point-of-Compliance Wells	Sufficient distance exists between the plume and point-of-compliance to locate several wells.	Yes
Institutional Controls	Ground Water Use Control	Land Use Control/Regulate Well Permits	Plume area is currently within the base boundary and land-use and ground water use are under base jurisdiction.	Yes
		Seal/Abandon Existing Wells	No production wells are known to exist in the existing or predicted plume area.	No
		Point-of-Use Treatment	No ground water is extracted from the plume area for any use.	No
	Public Education	Meetings/ Newsletters	Base public relations and environmental management offices have many information avenues to inform workers and residents.	Yes
Containment of Plume	Hydraulic Controls	Passive Drain Collection	Existing stormwater drain near Cambridge Street partially intercepts ground water. Drain could be expanded.	Yes
		Minimum Pumping/Gradient Control	A line or semicircle of vertical pumping wells could be located along the leading edge of plume to intercept and halt the advance of the plume.	Yes
	Physical Controls	Slurry Walls/Grout Curtains	Requires significant disruption of a residential area.	No
		Sheet Piling	Requires significant disruption of a residential area.	No
	Reactive/Semi-Permeable Barriers	Biologically Active Zones	Natural biodegradation of BTEX compounds can be stimulated by allowing contaminated ground water to flow through an aquifer zone which has enhanced oxygen and nutrient conditions.	Yes

TABLE 6.2 (Continued)
INITIAL TECHNICAL IMPLEMENTABILITY SCREENING OF
TECHNOLOGIES AND PROCESS OPTIONS FOR GROUND WATER REMEDIATION
UST SITE 870 INTRINSIC REMEDIATION EE/CA
HILL AFB, UTAH

General Response Action	Technology Type	Process Option	Implementability	Retain
<i>In Situ</i> Treatment	Biological	Oxygen and Nutrient Enhanced Biodegradation	Differs from biologically active zone in that oxygen and nutrients are injected upgradient of plume and allowed to migrate downgradient. In theory, this method can more rapidly reduce higher BTEX concentrations in and immediately downgradient of the source area.	Yes
	Chemical/Physical	Intrinsic Remediation	A combination of natural biological, chemical, and physical removal mechanisms which occur to varying degrees on every site. Ground water sampling at UST Site 870 indicates that this is a major, ongoing remediation process.	Yes
		Air Sparging (Volatilization)	Injection of air into contaminated aquifer creating a mass transfer of BTEX into air bubbles and into vadose zone. Limited radius of influence and short-circuiting are common problems.	No
Aboveground Ground Water Treatment	Ground Water Extraction	Vertical Pumping Wells	Entire ground water plume is pumped by installing numerous wells with submersible pumps. High cost and major disruption to residential area.	No
		Downgradient Horizontal Drains	See Passive Drain Collection.	Yes
	Biological	Bioreactors	High flow rates require excessive retention times and large reactors. BTEX is often volatilized in these systems.	No
	Chemical/Physical	Air Stripping	Cost-effective technology for removing varying concentrations of BTEX at higher flow rates. Potential permitting for air emissions.	Yes
		Activated Carbon	Cost prohibitive for more concentrated BTEX. Creates a carbon disposal problem.	No
		UV/Ozone Reactors	High flow rates require excessive retention times and large, expensive reactors.	No

TABLE 6.2 (Continued)
INITIAL TECHNICAL IMPLEMENTABILITY SCREENING OF
TECHNOLOGIES AND PROCESS OPTIONS FOR GROUND WATER REMEDIATION
UST SITE 870 INTRINSIC REMEDIATION EE/CA
HILL AFB, UTAH

General Response Action	Technology Type	Process Option	Implementability	Retain
Aboveground Treatment	Direct Discharge to Industrial Waste Water Treatment Plant (IWWTP)		Viable option when an IWWTP is available and capable of handling BTEX and hydraulic loading.	Yes
Treated Ground Water Disposal	Discharge to IWWTP or Sanitary Sewer	IWWTP	Viable option when access to industrial sewer exists and hydraulic loading is acceptable.	Yes
		Sanitary Sewer	Viable option when access to sanitary sewer exists and hydraulic loading is acceptable.	Yes
	Treated Ground Water Reinjection	Vertical Injection Wells	Not recommended due to clogging and high maintenance.	No
		Injection Trenches	Less clogging than wells but still require large trenches and can be subject to injection well permitting.	Yes
	Discharge to Surface Waters	Storm Drains	Viable option but generally requires NPDES or other discharge permit.	Yes
Source Removal/Soil Remediation	Mobile LNAPL Recovery	Dual-Pump Systems	Best suited for sites with >1 foot mobile LNAPL where aboveground ground water treatment already exists	No
		Skimmer Pumps/Bailers/Wicks	Best suited for sites with <1 foot mobile LNAPL where ground water pumping is undesirable.	Yes
		Total Fluids Pumping	Best suited for sites with thin saturated zones where excessive ground water will not be pumped.	Yes
		Bioslurping	Combined vapor extraction, bioventing, and mobile LNAPL recovery system has been operated at the site with limited success.	Yes
	Excavation/Treatment	Biological Landfarming	Deep excavation is not feasible at this site due to surface structures.	No

TABLE 6.2 (Concluded)
INITIAL TECHNICAL IMPLEMENTABILITY SCREENING OF
TECHNOLOGIES AND PROCESS OPTIONS FOR GROUND WATER REMEDIATION
UST SITE 870 INTRINSIC REMEDIATION EE/CA
HILL AFB, UTAH

General Response Action	Technology Type	Process Option	Implementability	Retain
	Excavation/ Treatment (cont'd)	Thermal Desorption	Deep excavation is not feasible at this site due to surface structures.	No
	<i>In Situ</i>	Bioventing	Air injection to stimulate biodegradation of fuel residuals. System currently operating in source area.	Yes
		Soil Vapor Extraction	Vapor extraction has been successfully implemented at other Hill AFB sites. Requires expensive off-gas treatment.	Yes

influence the technical effectiveness, implementation, and relative cost of technologies for remediating shallow ground water underlying and migrating from the site.

The general response actions retained for consideration in the development of remedial alternatives include long-term monitoring institutional controls, *in situ* treatment (intrinsic remediation), plume containment, bioventing, soil vapor extraction, mobile LNAPL removal and ground water collection and aboveground treatment (air stripping) and ground water disposal in the base industrial waste water treatment plant (IWWTP).

6.3 BRIEF DESCRIPTION OF REMEDIAL ALTERNATIVES

This section describes how remedial technologies retained from the screening process were combined into three remedial alternatives for UST Site 870. Sufficient information on each remedial alternative has been provided to facilitate a comparative analysis of effectiveness, implementability, and cost in Section 6.4.

6.3.1 Alternative 1 - Continued Mobile LNAPL Removal and Bioventing in Source Area, Intrinsic Remediation, Institutional Controls with Long-Term Monitoring

Mobile LNAPL recovery operations have been underway at UST Site 870 for over 1 year. To date, approximately 700 gallons of JP-4 have been recovered from one skimmer pump and 5 to 7 wells with sorbent wicks located in the source area. Limited bioventing is also underway in the source area. A two-well bioventing system is currently injecting air into the subsurface and providing oxygen to approximately 15,000 cubic yards of the most contaminated vadose soils. Under this alternative, existing mobile LNAPL removal and bioventing activities would be continued, but no additional source removal technologies would be employed. Because the area of remediation under this alternative is limited to soils north of Sixth Street and because LNAPL recovery is a slow process, it is conservatively estimated that a 5-percent annual reduction in source BTEX will occur with this alternative.

Intrinsic remediation is achieved when naturally occurring attenuation mechanisms bring about a reduction in the total mass of a contaminant in the soil or dissolved in ground water. Intrinsic remediation results from the integration of several subsurface attenuation mechanisms that are classified as either destructive or nondestructive. Destructive attenuation mechanisms

include biodegradation, abiotic oxidation, and hydrolysis. Nondestructive attenuation mechanisms include sorption, dilution (caused by dispersion and infiltration), and volatilization. In some cases, intrinsic remediation will reduce dissolved-phase contaminant concentrations below numerical concentration goals, thus protecting human health and the environment. Based on the existing evidence of intrinsic remediation described in Sections 4 and 5, these processes are occurring and will continue to reduce contaminant mass as the plume advances. Figures 5.9, 5.10, and 5.11 illustrate the projected BTEX plume migration and concentration reductions that should take place when 5 percent of the BTEX source is removed each year through limited mobile LNAPL recovery and bioventing. Based on model predictions, the BTEX plume will approach the Cambridge Street storm drain in approximately 1 to 4 years at concentrations of exceeding 1 µg/L. During years 4 through 7, the Bioplume II model predicts that the combination of source reductions and intrinsic remediation within the BTEX plume will significantly reduce its size and concentration.

A 5-percent annual LNAPL recovery/reduction was selected as a reasonable removal rate of BTEX concentrations emanating from mobile LNAPL at the site. A 5-percent annual BTEX source recovery/reduction could accomplish this. The most important physical processes contributing to BTEX source weathering are volatilization and dissolution. The dissolution of BTEX compounds from LNAPL is accomplished through interfacial dissolution at the fuel/water interface and dissolution into precipitation that is percolating downward.

The 5-percent annual BTEX loss was selected for comparison purposes only, and is not intended to reflect an actual rate of BTEX source reduction. On the basis of previous fuelspill investigations in similar soils at Wurtsmith AFB, BTEX constituents in mobile LNAPL decreased at rates exceeding 70 percent per year through natural weathering (Parsons ES, 1995). Approximately 1,500 gallons of JP-4 released into a shallow, sandy aquifer at Wurtsmith AFB in October 1988 had weathered to low residual-phase concentrations (<150 µg/L) without measurable free-product by June 1991. BTEX compounds in LNAPL are being similarly weathered at UST 870, as seen by a decrease in BTEX concentrations in LNAPL over time (Table 4.1). The LNAPL sample taken from MW-10 exhibited a 70percent loss of BTEX constituents relative to fresh LNAPL (JP-4). Hence, the partitioning strength of BTEX compounds in LNAPL contamination is diminishing not only from engineered removal (bioslurpers), but also from natural weathering. Regardless of the value used to estimate annual BTEX source reductions, the calibrated model predicts that groundwater will not

migrate past the base boundary, with the front of the plume stabilizing near Cambridge Street (assuming current conditions are not compromised with further fuel spills). The BTEX plume is expected to disappear from overwhelming natural attenuation mechanisms once BTEX source concentrations are reduced to approximately 50 percent of their current concentration.

Implementation of Alternative 1 would require the use of institutional controls such as land use restrictions and long-term monitoring. Land use restrictions may include placing long-term restrictions on soil excavation within the source area and ground water well installations within and downgradient of the source area. The intent of these restrictions would be to reduce potential receptor exposure to contaminants by legally restricting activities within areas affected by site-related contamination.

As a minimum, ground water monitoring would be conducted twice annually as part of this remedial technology to evaluate the progress of natural attenuation processes. Based on the potential plume migration, the Cambridge Street stormwater drain could be impacted by benzene at concentrations approaching the Federal MCLs. Section 7 discusses the proposed locations of LTM wells, a contingency sampling point located at the stormwater sewer outfall and three POC wells that would be used to identify the potential migration of contaminated ground water into or beyond the Cambridge Street stormwater sewer. These wells would be screened across the first 5 to 10 feet of the shallow aquifer to provide some early warning of the advance of the plume toward the base boundary. The stormwater discharge from the Cambridge Street sewer would act as the contingency sampling point that will be sampled only if Federal MCLs are first exceeded at the Cambridge Street and Yorktown Street LTM location. This contingency sampling point will be used to verify hydraulic connection between the shallow ground water and this potential pathway. Detection of benzene in excess of 5 µg/L at the POC wells or stormwater discharge point would trigger a reevaluation of remedial options to ensure that MCLs are not exceeded at the stormwater discharge point.

Public education on the selected alternative will be developed to inform base personnel and residents of the scientific principles underlying source reduction and intrinsic remediation. This education could be accomplished through public meetings, presentations, press releases, and posting of signs where appropriate. Periodic site reviews could also be conducted every year using data collected from the long-term ground water monitoring program. The purpose

of these periodic reviews would be to evaluate the extent of contamination, assess contaminant migration and attenuation over time, document the effectiveness of institutional controls at the site, and reevaluate the need for additional remedial actions at the site.

6.3.2 Alternative 2 - Continued Mobile LNAPL Recovery and Bioventing, Intrinsic Remediation, Institutional Controls with Long-term Ground Water Monitoring, Stormwater Treatment

This alternative is identical to Alternative 1 except that it includes a provision for stormwater treatment if MCLs are exceeded at the stormwater discharge point (Contingency sampling point). Construction of a passive ground water collection trench was considered but deemed unnecessary given the very low concentration of BTEX expected near the storm sewer. Aboveground treatment of stormwater using a portable sparging tank will be included to ensure that benzene concentrations in excess of MCLs do not pose a threat to human or ecological receptors at the stormwater discharge pond. Stormwater would be treated using a simple air sparging tank that would strip BTEX compound from the stormwater prior to discharge to the pond. This alternative would supplement intrinsic remediation by ensuring that any ground water with BTEX concentrations exceeding MCLs is treated before it completes a potential exposure pathway. As with Alternative 1, institutional controls and long-term monitoring would be required. The presence of benzene in excess of 5 µg/L at POC wells could also trigger the need for additional ground water remediation downgradient of Cambridge Street to ensure contaminated ground water does not migrate off-base.

A low-flow weir would be constructed at the stormwater discharge point to convey only stormwater through the sparge tank at rates the system is capable of handling. In this event that stormwater runoff exceeds the capacity of the weir (and the sparge tank system), the excess stormwater will be discharged directly to collection ponds without treatment. Although excess water would not be treated, the anticipated risk of BTEX contamination would be very low due to dilution of the BTEX compounds.

6.3.3 Alternative 3 - Expanded Mobile LNAPL Removal and Bioventing, Intrinsic Remediation, Institutional Controls and Long-Term Monitoring

This remedial alternative couples several remedial technologies to more aggressively address both mobile LNAPL and residual LNAPL contamination in soil and ground water at UST Site 870. The objective of this alternative would be to more rapidly reduce the partitioning of BTEX from mobile LNAPL and soils and to ensure that no contaminated ground water migrated into or beyond the Cambridge Street stormwater sewer. The source removal technologies considered for mobile LNAPL and residual LNAPL contamination in the soil and capillary fringe are mobile LNAPL recovery using LNAPL recovery pumps, soil vapor extraction, and bioventing.

A maximum of 4 feet of apparent floating mobile LNAPL was discovered at UST Site 870 during recent field investigations. Current mobile LNAPL recovery efforts are focused in the spill source area, although the estimated areal extent of mobile LNAPL contamination at the site extends downgradient of this area (Section 4). More intensive mobile LNAPL recovery could be accomplished by installing conventional skimmer pumps in available 4-inch ground water monitoring wells containing mobile LNAPL. As a supplement to these pumps, it would also be necessary to install additional product recovery wells and total fluid recovery pumps downgradient of current product recovery wells. Any recovered product would be separated in an oil/water separator, and transported offsite for recycling or disposal in a permitted treatment, storage, and disposal facility for waste oil. It was assumed that contaminated water could be transported to the base industrial wastewater sewer system.

The leading edge of the migrating mobile LNAPL area shown in Figure 4.1 would be targeted for mobile LNAPL recovery. For estimating purposes five, 6-inch diameter mobile LNAPL recovery wells would be installed in a line between CPT-14 and MW-10 to more rapidly remove this source of BTEX contamination. A total-fluids recovery system is recommended to remove LNAPL and small quantities of water from this area. It is important to note that even in optimum, coarse-grained soils, a 30- to 50-percent recovery of the spilled fuel is considered excellent.

Much of the remaining 50 to 70 percent of the fuel is more tightly occluded and bound in the micropore structure of the soil. Removal of this residual fuel can be accomplished using either soil vapor extraction or bioventing technologies. Bioventing is an *in situ* process where

low-flow air injection is used to enhance the biodegradation of organic contaminants in subsurface soils. Soil vapor extraction focuses on rapidly removing the volatile fraction of fuels through extracting soil vapor at higher rates. Both technologies have been successfully applied at JP-4 contaminated sites on Hill AFB (Hinchee, 1993). Bioventing is generally the technology of choice because unlike soil vapor extraction, bioventing uses a low rate of air injection that does not create vapor emissions to the atmosphere. Utah strictly limits VOC emissions, and the cost of soil vapor extraction is nearly doubled when vapor treatment is required. Although bioventing has been selected for this alternative, special flux monitoring will be required if air injection is proposed for the capillary fringe contamination beneath the residential area.

Extensive pilot- and full-scale testing of the bioventing technology at Hill AFB has resulted in significant reductions in soil BTEX and TPH. At Site 388, JP-4 jet fuel biodegradation rates were estimated at 2,500 milligrams of TPH per kilogram of soil per year (ES, 1994). Based on an estimated 60-foot radius of oxygen influence observed at Site 388, construction of a bioventing system at UST Site 870 could require approximately 11 vertical vent wells to influence the estimated 120,000 square feet of area with BTEX-impacted soils exceeding 50 mg/Kg total BTEX. Four-inch-diameter wells could be used, and screened intervals would be installed over the thin contaminated soil interval just above the water table. A single 20-horsepower blower system should be capable of supplying air (oxygen) to this soil volume. Operational emphasis would be placed on the destruction of BTEX compounds in the capillary fringe to significantly reduce this source of continuing ground water contamination.

Although bioventing is primarily used to address vadose (unsaturated) soil contamination, field demonstrations have shown an increase in DO concentration levels in phreatic soil and ground water (Barr, 1993). The increase in DO concentrations within the capillary fringe and ground water can facilitate biodegradation of dissolved hydrocarbon contamination.

In order to estimate the potential impact of this more intensive source removal on the downgradient plume expansion, a 15-percent per year reduction in the BTEX source term was factored into the Bioplume II model. This assumes that the more extensive mobile LNAPL removal and bioventing systems will be able to remove BTEX three times faster than the current source removal rates assumed under Alternatives 1 and 2. Figure 5.13 illustrates the predicted BTEX plume migration after 3 years of more intensive source removal. The model

predicts that after 3 years, BTEX concentration will approximately one-half of those encountered with Alternative 1 and 2 after the same 3-year period. Based on these model predictions, the combined effect of intensive source removal and intrinsic remediation would reduce the likelihood of BTEX migration in excess of Federal MCLs beyond the POC wells and into the Cambridge Street storm drain. Under this scenario, the need for treatment of the stormwater discharge seems unlikely.

Although more intensive source removal would more rapidly decrease dissolved BTEX concentrations and accelerate intrinsic remediation, it would not eliminate the need for short-term institutional controls and long-term monitoring. The required time frame for institutional controls and long-term monitoring could be shortened by approximately 4 to 5 years if this alternative were implemented.

6.4 EVALUATION OF ALTERNATIVES

This section provides a comparative analysis of each of the three remedial alternatives based on the effectiveness, implementability, and cost criteria. A summary of this evaluation is found in Table 6.6 at the end of this section.

6.4.1 Alternative 1 - Continued Mobile LNAPL Removal and Bioventing in Source Area, Intrinsic Remediation, Institutional Controls with Long-Term Monitoring

6.4.1.1 Effectiveness

Section 5 of this document presents the results of the Bioplume II model completed to support the intrinsic remediation alternative at UST Site 870. The potential impacts of remaining mobile LNAPL on ground water contamination over time were incorporated into the model for this remedial alternative. Only the existing product recovery and bioventing systems in the spill area were included in this alternative because of the increasing cost and reduced efficiency of trying to recover a more dispersed mobile LNAPL layer in downgradient areas.

This assessment predicted that natural attenuation mechanisms will significantly limit contaminant migration and reduce contaminant mass and toxicity. However, the model

predicted a potential exceedance of the federal MCL for benzene at the POC wells (Figure 7.1) and a potential risk of exposure at the outfall of the Cambridge Street stormwater sewer. Because the Bioplume II model is based upon numerous conservative assumptions and does not fully account for the anaerobic biodegradation available due to sulfate and other electron acceptors, it is possible that BTEX concentrations in excess of Federal MCLs will never reach the POC wells or storm drain. Semiannual ground water monitoring at the POC wells and LTM wells along the leading edge of the existing plume would be critical to ensuring the protectiveness of this alternative. Detection of BTEX above Federal MCLs at the proposed Cambridge Street and Yorktown Street intersection LTM well would require sampling at a contingency sampling point located at the outfall of the Cambridge Street Stormwater sewer near Pond 5. This alternative would cease to be protective if the BTEX plume was intercepted by the storm drain and contaminated ground water was subsequently discharged into the stormwater pond.

The effectiveness of this remedial alternative requires that excavations or drilling within the source area be limited to properly protected site workers. Long-term land use restrictions will be required to ensure that shallow ground water will not be pumped or removed for potable use within, and approximately 500 feet in all directions from, the existing BTEX plume. Existing health and safety plans should be enforced to reduce risks from operating existing source reduction technologies and from installing and monitoring additional POC wells.

Compliance with program goals is one component of the long-term effectiveness evaluation criterion. Alternative 1 will satisfy program objectives designed to promote intrinsic remediation as a component of site remediation and to scientifically document naturally occurring processes.

Alternative 1 is based on the effectiveness of naturally occurring processes that minimize contaminant migration and reduce contaminant mass over time and the effectiveness of institutional controls. As described earlier, an investigation of the potential effectiveness of naturally occurring processes at UST Site 870 using field data and the Bioplume II model has demonstrated that the BTEX plume will be significantly reduced in size and mass in 4 to 7 years. The maximum distance traveled by the plume could be slightly beyond the Cambridge Street stormwater sewer, however, the mass of the BTEX will be significantly reduced during that time so that the maximum concentration of BTEX reaching the stormwater sewer is

below Federal MCLs. The sensitivity analysis completed on the Bioplume II model for this site (Section 5) suggests that even under the most conservative (i.e., worst-case) conditions, the naturally occurring processes at UST Site 870 should significantly reduce contaminant migration to a potential exposure point (the stormwater drain located along Cambridge Street). Aside from the administrative concerns associated with long-term enforcement of long-term land use restrictions and long-term ground water monitoring programs, this remedial alternative should provide reliable, continued protection.

For cost comparison purposes, and based on Bioplume modeling results, it is assumed that source removal will continue for 8 years and that dissolved benzene concentrations will exceed MCLs throughout the plume for approximately 8 years under Alternative 1. The 8-year time frame is a reasonable source removal goal based on predictions of successful source removal, both engineered and natural, that will approach, or exceed, 5 percent annually (Section 6.3.1). An additional 5 years of semi-annual ground water monitoring will be required to ensure that intrinsic remediation has uniformly reduced all BTEX compounds to levels below federal MCLs, resulting in a total treatment/monitoring time of approximately 13 years.

6.4.1.2 Implementability

Alternative 1 is not technically difficult to implement. Continued operation of existing mobile LNAPL recovery and bioventing systems will require minimal new construction. Existing procedures for mobile LNAPL removal and recycling will be followed. Installation of POC ground water monitoring wells is a standard procedure at Hill AFB. Long-term management efforts will be required to ensure proper sampling procedures are followed. Periodic site reviews should be conducted to confirm the adequacy and completeness of long-term monitoring data and verify the effectiveness of this remediation approach. There may also be administrative concerns associated with long-term enforcement of ground water use restrictions. Future land use within the source area may be impacted by leaving contaminated soil and ground water in place. Regulators and the public will have to be informed of the benefits and limitations of the intrinsic remediation option. Educational programs are not difficult to implement, and the initial regulatory reaction to this alternative has been positive.

6.4.1.3 Cost

The cost of Alternative 1 is summarized in Table 6.3. Capital costs are limited to the construction of three new POC wells. The estimated cost of maintaining existing mobile LNAPL recovery and bioventing systems for 8 years are included in the \$372,000 present-worth cost estimate for Alternative 1. Also included are the costs of maintaining institutional controls and long-term ground water monitoring for a total of 13 years. The total present worth of this alternative is most sensitive to the estimated time requirement for intrinsic remediation to reduce benzene concentrations to less than the 5 µg/L MCL. Costs could be reduced by changing from semiannual to annual monitoring after the plume begins to recede.

**TABLE 6.3
ALTERNATIVE 1 - COST ESTIMATE
UST SITE 870 INTRINSIC REMEDIATION EE/CA
HILL AFB, UTAH**

Capital Costs	Cost
Design/Construct Three POC Wells	\$12,000
Operation, Maintenance and Monitoring Costs (Annual)	Annual Cost
Operate and Maintain Existing Mobile LNAPL Recovery and Bioventing Systems (8 years)	\$18,000
Ground Water Monitoring (12 wells - Semiannually 13 Years)	\$12,000
Maintain Institutional Controls/Public Education (13 years)	\$6,000
Project Management (13 years)	\$8,000
Present Worth of Alternative 1^{a/}	\$372,000

a/ Based on I=5%

6.4.2 Alternative 2 - Continued Mobile LNAPL Recovery and Bioventing in Source Area, Intrinsic Remediation, Institutional Controls with Long-Term Ground Water Monitoring, Stormwater Treatment

6.4.2.1 Effectiveness

The effectiveness of Alternative 1 is enhanced under Alternative 2 by ensuring that if stormwater becomes contaminated it will be treated to levels below federal drinking water MCLs before it is discharged to the stormwater pond. Air stripping technologies, including sparging tanks, are proven and reliable systems for reducing BTEX compound concentrations in water by more than 95 percent. The use of a low-flow diversion weir to treat only more concentrated BTEX-contaminated stormwater will reduce the size and complexity of the air stripping system. This alternative also complies with the program goals because intrinsic remediation remains the predominant decontamination method at the site.

6.4.2.2 Implementability

The addition of a small stormwater treatment system at the stormwater discharge point near the stormwater pond does not present any unique implementation problems. A 230-volt power source and a concrete pad would be required to support the portable sparging tank system. Additional time would be required for base personnel to sample influent and effluent to the sparging tank. The use of a sparging tank will minimize maintenance time. Some accumulation of iron and manganese sludge and biological sludge will occur in the tank. A properly designed tank will have a conical bottom to draw off sludge without interrupting the treatment process. Waste sludge should be nonhazardous.

The installation of POC wells, the institutional controls and long-term monitoring commitments described in Alternative 1 will also be implemented with this alternative. If benzene exceeds 5 µg/L at POC wells, additional ground water remediation may be required to ensure that contaminated ground water is not migrating beyond the base boundary.

6.4.2.3 Cost

The cost of Alternative 1 will be increased by the stormwater treatment system and maintenance and monitoring of the system. Based on Bioplume II model predictions, the

plume will begin to recede during the fourth year. For cost comparison purposes its is assumed that the stormwater treatment system will operate for 5 years to ensure that contaminated ground water is not discharged to the stormwater pond. As with Alternative 1, source reduction technologies would continue for 8 years under Alternative 2. Annual long-term monitoring would continue for an additional 5 years to ensure that intrinsic remediation is reducing contaminant concentrations below MCLs throughout the plume. The estimated capital and operating costs of Alternative 2 are shown in Table 6.4. The total present worth cost of Alternative 2 is \$455,000.

TABLE 6.4
ALTERNATIVE 2 - COST ESTIMATE
UST SITE 870 INTRINSIC REMEDIATION EE/CA
HILL AFB, UTAH

Capital Costs	Cost
Three POC Wells	\$12,000
Stormwater Treatment System	\$24,000
Operation, Maintenance and Monitoring Costs (Annual)	Annual Cost
Operate Existing Mobile LNAPL Recovery/Bioventing Systems (8 years)	\$18,000
Operate and Monitor Stormwater Treatment System (5 years)	\$14,000
Ground Water Monitoring (12 wells - Semiannually 13 Years)	\$12,000
Maintain Institutional Controls/Public Education (13 years)	\$6,000
Project Management (13 years)	\$8,000
Present Worth of Alternative 2^{a/}	\$455,000

a/ Based on i=5%.

6.4.3 Alternative 3 - Intensive Source Removal, Intrinsic Remediation, Institutional Controls and Long-Term Monitoring

6.4.3.1 Effectiveness

More intensive source removal coupled with intrinsic remediation and long-term monitoring should reduce the dissolved-phase BTEX plume concentrations and significantly reduce potential exposure at the Cambridge Street stormwater discharge. If a greater percentage of the mobile LNAPL could be removed and soil BTEX concentrations could be significantly reduced, the partitioning of BTEX into ground water would be reduced, thereby promoting a more rapid decrease in contaminant mass, mobility, and toxicity. It was assumed that mobile LNAPL removal and bioventing would continue for approximately 4 years. During these 4 years, the site model assumed that the total BTEX mass in the soil would be reduced by 60 percent and that average dissolved benzene concentrations at the center of the plume would be reduced to less than 5 µg/L as a result of intrinsic remediation.

Conceptually, this 15-percent annual reduction in a BTEX source from mobile LNAPL will be obtained from both natural weathering and increased engineered removal. Natural weathering rates of BTEX compounds in mobile LNAPL under similar conditions can be substantial (Section 6.3.1). Similar weathering losses of JP-4 contamination are occurring at Site UST 870. The assumed 15-percent annual reduction of BTEX constituents in mobile LNAPL does not necessarily represent actual weathering rates, but show potential LNAPL reduction rates as a result of increased LNAPL removal along with natural weathering. More intensive source removal could help achieve protectiveness approximately 4 years sooner than that under Alternative 1. The model predicts that with more intensive source removal, the BTEX plume will be less concentrated approaching the Cambridge Street stormwater sewer, and this exposure pathway may not be completed.

Site workers would have to handle and be exposed to larger volumes of extracted mobile LNAPL. Bioventing in the source area and downgradient smear zones would be an effective method of reducing the BTEX which could partition into shallow ground water. The toxicity of the soil would also be more rapidly reduced. Bioventing has been shown to preferentially remove BTEX compounds and reduce toxicity in soils (Miller, 1993). If air injection is used

beneath the residential area, additional monitoring will be required to ensure that vapors do not migrate upward into occupied buildings.

The more aggressive source removal component of this remedial alternative satisfies the statutory preference for using treatment to more rapidly reduce contaminant mobility and toxicity. Long-term natural attenuation processes will also reduce contaminant toxicity, mobility, and volume in ground water. Long-term land restrictions should be implemented to ensure that shallow ground water will not be available for use as a potable water source downgradient of the source area. A health and safety plan would be developed to mitigate risks from installing and operating the expanded mobile LNAPL recovery and bioventing system, and installing and monitoring POC wells. Thus, this remedial alternative should also minimize contaminant migration and provide long-term protection.

Alternative 3 also satisfies the program objectives of demonstrating the potential effectiveness of intrinsic remediation for minimizing plume expansion and reducing BTEX mass and toxicity. However, this remedial alternative will result in the generation of additional mobile LNAPL, ground water, drill cuttings, and other wastes requiring treatment and/or disposal. Alternative 3 (intensive source removal, intrinsic remediation, and long-term monitoring) should provide reliable, continuous protection with little risk from temporary system failures.

6.4.3.2 Implementability

Installing and operating a more intensive mobile LNAPL recovery, and bioventing system to remove the source of BTEX contamination at UST Site 870 will present additional implementability concerns. Installation involves standard drilling practices for wells, and limited excavation for piping and manifold connections. Implementation in and around residential areas would be disruptive to residents and their yards. Mobile LNAPL recovery and bioventing equipment is available, and small systems are already in place in the UST Site 870 spill area. Extraction wells required for product recovery represent a well-developed technology that has been proven at numerous sites. Bioventing is an innovative technology that has been used effectively at other JP-4 contaminated sites at Hill AFB. Implementation of this remedial alternative would also require flux monitoring during bioventing startup to confirm that soil vapors are not transmitted upward into residential buildings. Annual *in situ*

respiration testing is also required to verify that the system is working as expected. The technical and administrative implementability concerns associated with the intrinsic remediation and long-term monitoring component of this remedial alternative are identical to those discussed in Alternative 1, except the time frame is approximately 4 years shorter.

6.4.3.3 Cost

The total present worth of this alternative is estimated at \$782,000. The cost differential between Alternatives 2 and 3 is sensitive to the extent and duration of required LNAPL recovery, bioventing operations, and the accuracy of intrinsic remediation modeling results. Table 6.5 lists the costs for Alternative 3 based on a mobile LNAPL removal period of 4 years and a bioventing period of 4 years. During years 4 through 9, semiannual ground water monitoring will be conducted to verify that intrinsic remediation is reducing dissolved BTEX contaminants to levels below MCLs.

**TABLE 6.5
ALTERNATIVE 3 - COST ESTIMATE
UST SITE 870 INTRINSIC REMEDIATION EE/CA
HILL AFB, UTAH**

Capital Costs	Cost
Design/Construct 5 Mobile LNAPL Recovery Wells and Collection Systems	\$98,000
Design/Construct 11-Well Bioventing System	\$363,000
Design/Construct Three POC Wells	\$12,000
Operation, Maintenance and Monitoring Costs (Annual)	Annual Cost
Operate New Mobile LNAPL Recovery/ Bioventing Systems (4 years)	\$36,200
Ground Water Monitoring (12 wells - Semiannually Years 1-9)	\$12,000
Maintain - Institutional Controls/Public Education (9 years)	\$6,000
Project Management (9 years)	\$8,000
Present Worth of Alternative 3^{a/}	\$782,000

a/ Based on i=5%.

6.5 RECOMMENDED REMEDIAL APPROACH

Three multicomponent alternatives have been evaluated for remediation of the shallow ground water at UST Site 870. Alternatives evaluated include two levels of source removal, intrinsic remediation with long-term monitoring, and an alternative which would treat stormwater if it contained benzene or other BTEX compounds in excess of MCLs. Table 6.6 summarizes the results of this evaluation based upon effectiveness, implementability and cost criteria. Based on this evaluation, the Air Force recommends Alternative 2 as the best combination of risk reduction and cost effectiveness to achieve RAOs for dissolved-phase BTEX in UST Site 870 ground water.

Only marginal reductions in plume migration and risk reduction will be achieved if more intensive source removal is applied to the downgradient smear zone. These marginal reductions will come at a significant increase in cost and significant disturbance to a residential area during additional mobile LNAPL recovery well and bioventing system construction. Based on all effectiveness criteria, Alternative 2 will make maximum use of intrinsic remediation to reduce plume migration and toxicity while providing the assurance that if MCLs are exceeded at the stormwater discharge point, an effective treatment system can be rapidly installed to prevent completion of a very conservative exposure pathway.

TABLE 6.6
SUMMARY OF REMEDIAL ALTERNATIVE EVALUATION
GROUND WATER REMEDIATION
UST SITE 870 INTRINSIC REMEDIATION EE/CA
HILL AFB, UTAH

Remedial Alternative	Effectiveness	Implementability	Present Worth Cost Estimate
Alternative 1			\$372,000
- Limited Source Removal - Intrinsic Remediation - Long-Term Monitoring	Continued mobile LNAPL removal and bioventing will gradually remove BTEX source. Contaminant mass, volume and toxicity will be significantly reduced over next seven years. MCL for benzene could be exceeded at POC.	Readily implementable. Long-term management, ground water use controls and monitoring required for an estimated 13 years. Minimal exposure of site workers if excavation is carefully controlled in source area.	
Alternative 2			\$455,000
- Limited Source Removal - Intrinsic Remediation - Optional Stormwater Treatment - Long-Term Monitoring	Similar to Alternative 1 except it provides additional protection against benzene discharge into stormwater ponds and potential completion of exposure pathways to humans or ecological receptors. Portable sparging tank should be very effective in removing low levels of BTEX prior to discharge to pond.	Readily implementable. Long-term management, ground water controls, and monitoring required for an estimated 13 years. Would also require minor construction at stormwater outfall and operation of a simple sparging tank for approximately 5 years.	
Alternative 3			\$782,000
- Expanded Mobile LNAPL Removal and Bioventing - Intrinsic Remediation - Long-Term Monitoring	Most effective in reducing soil contamination and more rapidly reducing source of ground water contamination. May prevent BTEX from impacting POC wells if implemented immediately (1995). Could result in increased generation of secondary waste streams that would require additional treatment and disposal.	Difficult to implement in residential area without disruption and potential secondary risk to residents. Could reduce long-term management, ground water use controls and monitoring by 4-5 years compared to Alternative 1 and 2. Increased drilling and system maintenance will increase site worker exposure to contaminated soils and mobile LNAPL.	

All of the remedial alternatives are implementable, however, Alternative 2 significantly minimizes potential disruptions to base housing residents and should be acceptable to the public and regulatory agencies because it is protective of human health and the environment. Implementation of Alternative 2 will require land use and ground water use controls to be enforced for approximately 8 to 13 years with semiannual ground water monitoring. The cost of Alternatives 1 and 2 could be reduced if annual ground water monitoring is implemented once the plume began to recede.

The final evaluation criterion used to compare each of the three remedial alternatives was cost. It is the opinion of the Air Force that the additional cost of Alternative 2 over Alternative 1 is justified by the additional protection it provides. In contrast, the additional cost of Alternative 3 can not be justified by the marginal reduction in treatment and monitoring time that is gained from more intensive source removal.

SECTION 7

LONG-TERM MONITORING PLAN

7.1 OVERVIEW

As discussed in Section 6, the preferred remedial option for the fuel-hydrocarbon contamination present in ground water at UST Site 870 is Alternative 2. This alternative consists of continued mobile LNAPL recovery and bioventing for mobile- and residual-phase LNAPL contamination, and intrinsic remediation with LTM for contaminated ground water. In addition, this alternative has a provision for treatment of stormwater discharge should BTEX compounds in excess of MCLs be detected in stormwater runoff at the stormwater sewer outfall. In keeping with the requirements of this remedial alternative, a LTM plan must be developed. The purpose of LTM is to assess site conditions over time, confirm the effectiveness of naturally occurring processes at reducing contaminant mass and minimizing contaminant migration, validate/calibrate the Bioplume II model, and evaluate the need for additional remediation.

The LTM plan consists of identifying the locations of two separate ground water monitoring networks and developing a ground water and stormwater discharge point sampling and analysis strategy. The strategy described in this section is designed to monitor plume migration and attenuation over time to verify that intrinsic remediation of dissolved-phase BTEX is occurring at rates sufficient to protect potential receptors.

7.2 MONITORING NETWORKS

Two separate ground water monitoring networks will be used at UST Site 870 as part of the intrinsic remediation remedial alternative LTM plan. The first network will consist of nine LTM wells located upgradient, within, and downgradient of the observed total BTEX plume wells and a contingency sampling point at the Pond 5 outfall of the stormwater sewer located along Cambridge Street. The purpose of the LTM well network is to provide short-term confirmation and verification of intrinsic remediation and to verify the results of the

Bioplume II model. The second network of ground water monitoring points will consist of three POC wells. The purpose of the POC monitoring network is to verify that no BTEX compounds in concentrations exceeding MCLs migrate beyond the area under institutional control. Should BTEX compounds be detected through contingency sampling in the stormwater sewer discharge in excess of Federal MCLs, installation and operation of the stormwater treatment system discussed in Section 6 will be implemented. Should BTEX compounds be detected in POC wells above MCLs, other remedial options will be evaluated.

7.2.1 Long-Term Monitoring Network

Nine ground water monitoring wells placed upgradient, within, and immediately downgradient of the existing BTEX contaminant plume will be used to monitor the effectiveness of intrinsic remediation in reducing total contaminant mass and minimizing contaminant migration. Figure 7.1 shows the proposed locations of these wells. One new and four existing monitoring wells (MW-04, MW-05, EPA-82-D and MW-10) will be used as LTM wells to monitor natural attenuation within the anaerobic treatment zone and BTEX concentrations in the source area. In the event that MW-04 is screened to shallow to permit an accurate ground water sample, monitoring wells EPA-82-I, MW-01, or MW-14 should be considered as a substitute LTM location. One new LTM well should be placed within the aerobic treatment zone to monitor natural attenuation within this zone. Two new LTM wells should be placed downgradient of the BTEX plume. Sampling and analysis of the downgradient LTM well (and the POC wells) will be useful in monitoring changes in ground water chemistry through time and will facilitate early detection of plume migration. Because the velocity of the dissolved-phase BTEX plume is retarded relative to the advective ground water velocity and the velocities of the electron acceptors are not, depleted DO, nitrate, and sulfate concentrations, and elevated ferrous iron and methane concentrations will advance in front of the BTEX plume. Thus, changes in the concentrations of the electron acceptors can be used to provide early warning of BTEX plume encroachment on the LTM and POC wells.

An existing CPT monitoring point (CPT40) should be used as an upgradient LTM well. CPT-40 was selected as an upgradient LTM point because it has historically been free of ground water contamination and is suited for monitoring background levels of ground water electron acceptors, pH, and oxidation/reduction potential. The different well diameter of CPT-0 compared to the other proposed LTM wells is not a sampling issue because background levels of ground water parameters are presumed to be uniform throughout the

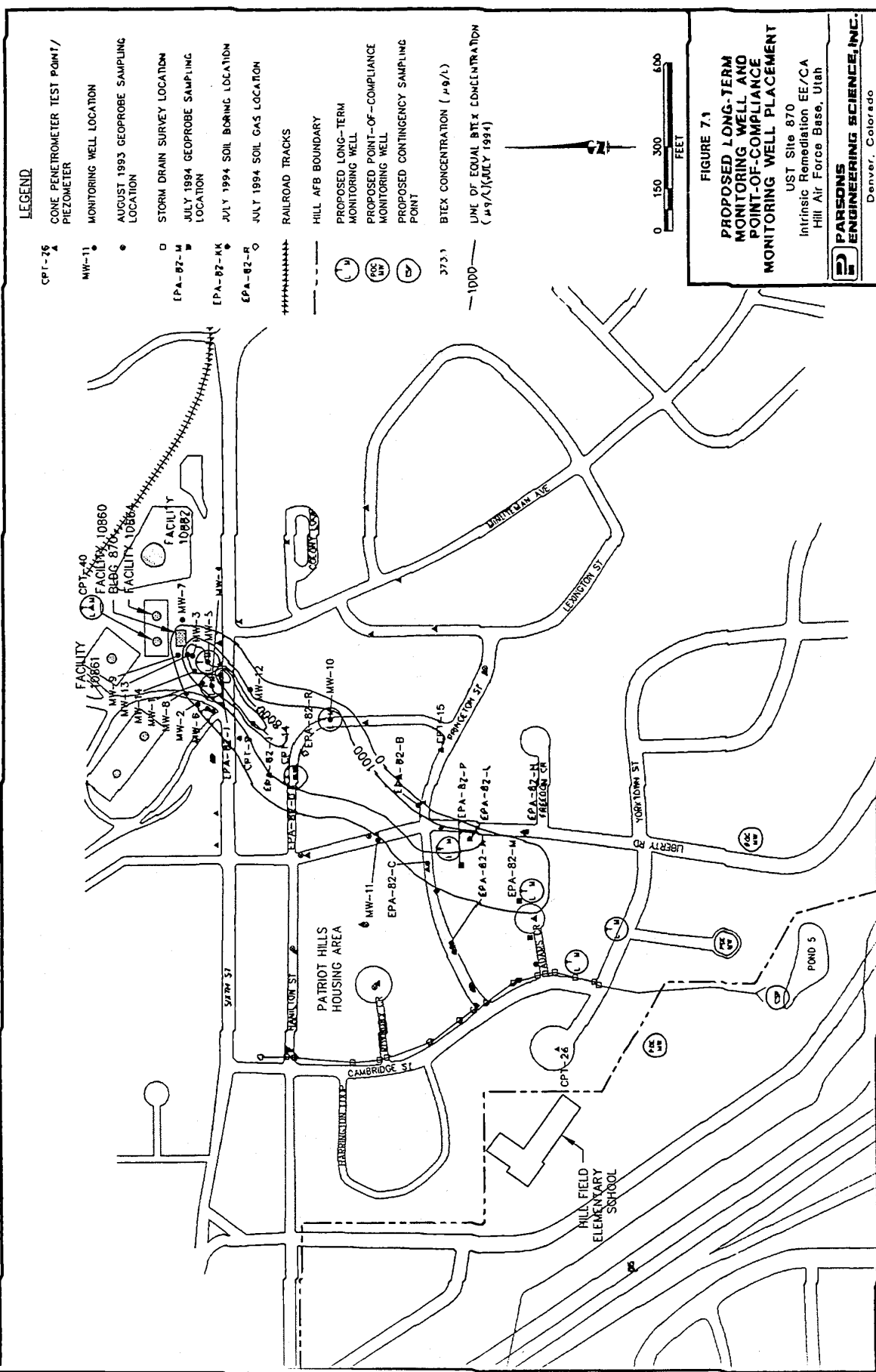

LEGEND

- CPT-26 CONE PENETROMETER TEST POINT/PIEZOMETER
- MW-11 MONITORING WELL LOCATION
- AUGUST 1993 GEOPROBE SAMPLING LOCATION
- STORM DRAIN SURVEY LOCATION
- EPA-82-W JULY 1994 GEOPROBE SAMPLING LOCATION
- EPA-82-KK JULY 1994 SOIL BORING LOCATION
- EPA-82-R JULY 1994 SOIL GAS LOCATION
- +++++ RAILROAD TRACKS
- HILL AFB BOUNDARY
- PROPOSED LONG-TERM MONITORING WELL
- PROPOSED POINT-OF-COMPLIANCE MONITORING WELL
- PROPOSED CONTINGENCY SAMPLING POINT
- 373.1 BTEX CONCENTRATION (µg/L)
- 1000— LINE OF EQUAL BTEX CONCENTRATION (µg/L)(JULY 1994)

FIGURE 7.1
PROPOSED LONG-TERM MONITORING WELL AND POINT-OF-COMPLIANCE MONITORING WELL PLACEMENT
 UST Site 870
 Intrinsic Remediation EE/CA
 Hill Air Force Base, Utah

PARSONS ENGINEERING SCIENCE, INC.
 Denver, Colorado

the shallow aquifer. In the case that CPT-40 is destroyed or inaccessible, a new LTM well (described in Section 7) will be installed instead.

The LTM network will supplement the POC monitoring network in monitoring plume migration and will allow model predictions to be validated. Such monitoring of the plume will allow additional response time if BTEX concentrations within the plume are increasing or if the plume begins to migrate further than expected. If Federal MCLs are exceeded in the proposed LTM well near the intersection of Cambridge Street and Yorktown Street, additional samples will be taken at the Cambridge Street stormwater outfall which will act as a contingency sampling point (Figure 7.1). New LTM wells should be constructed of 2-inch PVC with 5 to 10 feet of 0.010-inch slotted screen. The screened interval should be within the same stratigraphic horizon as the contaminant plume. The screened interval should be chosen so that the base of the screen coincides with the interface between the sandy saturated zone and the underlying competent clay to silty clay and the top of the screen is above the seasonal high water table.

7.2.2 Point-of-Compliance Monitoring Network

Three new POC monitoring wells should be installed to verify that no contaminated ground water exceeding MCLs migrates beyond the area under institutional control. Figure 7.1 shows the proposed locations for the POC wells. POC sampling points will be used to demonstrate protection of human health and the environment and compliance with site specific numerical remediation goals (i.e., MCLs for the BTEX constituents).

As described for the LTM wells, the POC wells also should be screened in the same hydrogeologic unit as the contaminant plume. Data presented in this report concerning the nature and extent of contamination at the site suggest that a 5- to 10-foot screen extending from slightly above the ground water table to the interface between the sandy saturated zone and the underlying competent clay to silty clay confining unit should be used to monitor changes in ground water chemistry at these locations. New POC wells should be constructed of 2-inch PVC and a 0.010-inch slotted screen should be used.

7.3 GROUND WATER SAMPLING AND ANALYSIS

To ensure that sufficient contaminant removal is occurring at UST Site 870 to protect human health and the environment and meet site-specific remediation goals, the LTM plan includes a comprehensive sampling and analysis plan. To supplement the LTM sampling and

analysis plan presented herein, a site-specific ground water sampling and analysis plan should be prepared prior to initiating the LTM program.

7.3.1 Analytical Protocol

7.3.1.1 Long-Term Monitoring Well Analytical Protocol

All LTM wells will be sampled and analyzed to monitor trends in ground water chemistry and to verify the effectiveness of intrinsic remediation at the site. Water level measurements are to be made during each sampling event. All ground water samples from LTM wells will be analyzed according to the analytical protocol presented in Table 7.1. Any water samples collected from the stormwater sewer outfall contingency sampling point should be sampled for aromatic hydrocarbons only. A site-specific ground water sampling and analysis plan should be prepared using this analytical protocol prior to initiating the LTM program.

7.3.1.2 Point-Of-Compliance Monitoring Point Analytical Protocol

All POC sampling points will be sampled and analyzed to monitor trends in ground water chemistry, to verify the effectiveness of intrinsic remediation at the site, and to demonstrate protection of human health and the environment and compliance with site-specific numerical remediation goals. Water level measurements are to be made in POC wells during each sampling event. All ground water samples from POC wells will be analyzed according to the analytical protocol presented in Table 7.2. A site-specific ground water sampling and analysis plan should be prepared using this analytical protocol prior to initiating the LTM program.

7.3.2 Frequency

Each of the LTM and POC sampling points will be sampled twice each year for 13 years. If the data collected during this time period supports the anticipated effectiveness of the intrinsic remediation alternative at this site, the sampling frequency can be reduced to once every year for all wells in the LTM program, or eliminated. The contingent sampling point (located at the Cambridge Street stormwater outfall) will be sampled only if BTEX is detected above MCLs at the LTM well near the intersection of Cambridge Street and Yorktown Street. If the data collected at any time during the monitoring period indicate the need for additional remedial activities at the site (i.e., by exceeding MCLs at POC locations) sampling frequency should be adjusted accordingly.

TABLE 7.1
LONG-TERM MONITORING ANALYTICAL PROTOCOL
UST SITE 870 INTRINSIC REMEDIATION EE/CA
HILL AFB, UTAH

Analyte	Method/Reference	Comments	Data Use	Recommended Frequency of Analysis	Sample Volume, Sample Container, Sample Preservation	Field or Fixed-Base Laboratory
Ferrous (Fe^{2+})	Colorimetric A3500-Fe D	Field only	Elevated ferrous iron concentrations may be indicative of the anaerobic biodegradation process of iron reduction	Semiannually	Collect 100 mL of water in a glass container, acidify with hydrochloric acid per method	Field
Ferrous (Fe^{2+})	Colorimetric HACH 25140-25	Alternate method; field only	Elevated ferrous iron concentrations may be indicative of the anaerobic biodegradation process of iron reduction	Semiannually	Collect 100 mL of water in a glass container	Field
Temperature	E170.1	Field only	Metabolism rates for microorganisms depend on temperature	Semiannually	N/A	Field
Dissolved Oxygen	Dissolved oxygen meter	Refer to Method A4500 for a comparable laboratory procedure	The oxygen concentration is a data input to the Biophume II mode; concentrations less than 1 mg/L generally indicate an anaerobic pathway	Semiannually	Collect 300 mL of water in biochemical oxygen demand bottles; analyze immediately, alternately, measure dissolved oxygen in situ	Field
pH	E150.1/SW9040, direct reading meter	Protocols/Handbook methods ^a	Aerobic and anaerobic processes are pH-sensitive	Semiannually	Collect 100-250 mL of water in a glass or plastic container, analyze immediately	Field
Conductivity	E120.1/SW9050, direct reading meter	Protocols/Handbook methods	General water quality parameter used as a marker to verify that site samples are obtained from the same ground water system	Semiannually	Collect 100-250 mL of water in a glass or plastic container	Field
Nitrate (NO_3^{-1})	IC method E300 or method SW9056; colorimetric, method E353.2	Method E300 is a Handbook method; method SW9056 is an equivalent procedure	Substrate for microbial respiration if oxygen is depleted	Semiannually	Collect up to 40 mL of water in a glass or plastic container, cool to 4°C, analyze within 48 hours	Fixed-base

TABLE 7.1 (CONCLUDED)
LONG-TERM MONITORING ANALYTICAL PROTOCOL
UST SITE 870 INTRINSIC REMEDIATION EE/CA
HILL AFB, UTAH

Analyte	Method/Reference	Comments	Data Use	Recommended Frequency of Analysis	Sample Volume, Sample Container, Sample Preservation	Field or Fixed-Base Laboratory
Sulfate (SO ₄ ²⁻)	IC method E300 or method SW9056 or HACH SulfaVer 4 method	Method E300 is a Handbook method; method SW9056 is an equivalent procedure. HACH method is Photometric	Substrate for anaerobic microbial respiration	Semiannually	Collect up to 40 mL of water in a glass or plastic container; cool to 4°C	Fixed-base or field (for HACH method)
Redox potential	A2580 B	Measurements are made with electrodes; results are displayed on a meter, samples should be protected from exposure to atmospheric oxygen	The redox potential of ground water influences and is influenced by biologically mediated reactions; the redox potential of ground water may range from more than 200 mV to less than -400 mV	Semiannually	Collect 100-250 mL of water in a glass container, filling container from bottom; analyze immediately	Field
Methane	RSKOP-114 modified to analyze water samples for methane by headspace sampling with dual thermal conductivity and flame ionization detection.	Method published and used by the US Environmental Protection Agency Robert S. Kerr Laboratory	The presence of methane suggests BTEX degradation via an anaerobic pathway utilizing carbon dioxide (carbonate) as the electron acceptor (methanogenesis)	Semiannually	Collect water samples in 40 mL volatile organic analysis (VOA) vials with butyl gray/Teflon-lined caps (zero headspace); cool to 4°C	Fixed-base
Aromatic hydrocarbons (BTEX)	Purge and trap GC method SW8020	Handbook method; analysis may be extended to higher molecular weight alkylbenzenes	BTEX is the primary target analyte for monitoring natural attenuation; BTEX concentrations must also be measured for regulatory compliance	Semiannually	Collect water samples in a 40 mL VOA vial with zero headspace; cool to 4°C; add hydrochloric acid to pH 2	Fixed-base

a/ Protocol methods are presented by Wiedemeier *et al.*, 1994

TABLE 7.2
POINT-OF COMPLIANCE MONITORING ANALYTICAL PROTOCOL
UST SITE 870 INTRINSIC REMEDIATION EE/CA
HILL AFB, UTAH

Analyte	Method/Reference	Comments	Data Use	Recommended Frequency of Analysis	Sample Volume, Sample Container, Sample Preservation	Field or Fixed-Base Laboratory
Temperature	E170.1	Field only	Well development	Semiannually	N/A	Field
Dissolved Oxygen	Dissolved oxygen meter	Refer to method A4500 for a comparable laboratory procedure	The oxygen concentration is a data input to the Bioplume model; concentrations less than 1 mg/L generally indicate an anaerobic pathway	Semiannually	Collect 300 mL of water in biochemical oxygen demand bottles; analyze immediately, alternately, measure dissolved oxygen in situ	Field
pH	E150.1/SW9040, direct reading meter	Protocols/Handbook methods ^{a/}	Aerobic and anaerobic processes are pH-sensitive	Semiannually	Collect 100-250 mL of water in a glass or plastic container, analyze immediately	Field
Conductivity	E120.1/SW9050, direct reading meter	Protocols/Handbook methods	General water quality parameter used as a marker to verify that site samples are obtained from the same ground water system	Semiannually	Collect 100-250 mL of water in a glass or plastic container	Field
Redox potential	A2580 B	Measurements are made with electrodes; results are displayed on a meter; samples should be protected from exposure to atmospheric oxygen	The redox potential of ground water influences and is influenced by biologically mediated reactions; the redox potential of ground water may range from more than 200 mV to less than -400 mV	Semiannually	Collect 100-250 mL of water in a glass container, filling container from bottom; analyze immediately	Field
Aromatic hydrocarbons (BTEX)	Purge and trap GC method SW8020	Handbook method; analysis may be extended to higher molecular weight alkylbenzenes	BTEX is the primary target analyte for monitoring natural attenuation; BTEX concentrations must also be measured for regulatory compliance	Semiannually	Collect water samples in a 40 mL VOA vial with zero headspace; cool to 4°C; add hydrochloric acid to pH 2	Fixed-base

a/ Protocol methods are presented by Wiedemeier *et al.*, 1994

SECTION 8

CONCLUSIONS AND RECOMMENDATIONS

This report presents the results of an EE/CA conducted by Parsons ES in conjunction with researchers from the USEPA RSKERL to determine the potential for intrinsic remediation of, and to develop an appropriate remedial alternative for, BTEX compounds dissolved in the shallow ground water at UST Site 870, Hill AFB, Utah. Previous investigations determined that JP-4 jet fuel had been released into the soil and shallow ground water at the site through POL operations. Chemical analysis of a sample of mobile LNAPL confirms that residual- and mobile-phase LNAPL contamination at the site is probably dominated by weathered JP4 jet fuel. The main emphasis of the work described herein was to evaluate the potential for naturally occurring degradation mechanisms to reduce dissolved-phase fuel-hydrocarbon concentrations in ground water to levels that are protective of human health and the environment.

To collect the data necessary for the intrinsic remediation demonstration, Parsons ES and USEPA researchers collected soil and ground water samples from the site. Physical and chemical data collected under this program were supplemented with data collected during previous site characterization events. Site-specific geologic, hydrologic, and laboratory analytical data were then used in the Bioplume II numerical ground water model to simulate the effects of advection, dispersion, sorption, and biodegradation on the fate and transport of the dissolved-phase BTEX plume. Extensive site-specific data were used for model implementation. Model parameters that could not be obtained from existing site data were estimated using widely accepted literature values for sediments similar to those found at the site. Conservative aquifer parameters were used to construct the Bioplume II model for this study, and therefore, the model results presented herein represent a worst-case scenario. Actual dissolved-phase BTEX degradation rates observed during LTM at the site will probably be greater than predicted by this study. This will result in faster removal rates for the BTEX compounds and a shorter plume migration distance than predicted by the Bioplume II model.

The Bioplume II model predicts that the BTEX plume will approach the stormwater sewer that runs parallel to Cambridge Street in 1 to 4 years at concentrations of approximately 1 µg/L. After this time, the plume will recede somewhat and reach steady-state equilibrium (continuous source), or will continue to recede until the plume disappears (source reduction). Ground water geochemistry suggests that DO, nitrate, ferric hydroxide, sulfate, and carbon dioxide present in site ground water have the capacity to assimilate at least 31,370 µg/L of total BTEX. The highest plausible total BTEX concentration observed at the site was 26,576 µg/L in August 1992. Based on site observations, ground water at the POL site has enough assimilative capacity to degrade dissolved-phase BTEX that partitions from the LNAPL plume into the ground water before the plume migrates 1,600 feet downgradient from the source area.

The results of the modeling effort and the intrinsic remediation demonstration indicate that dissolved-phase petroleum hydrocarbon contamination present in ground water poses no significant risk to human health or the environment in its present known, or predicted future, concentration and distribution. It is therefore recommended that intrinsic remediation with LTM be implemented for dissolved-phase BTEX contamination found in ground water at this site. To reduce sources of continuing contamination, it is also recommended that mobile LNAPL recovery operations and bioventing activities currently operating at the site be continued.

To verify the predictions made during the Bioplume II modeling effort and to monitor the long-term migration and degradation of the contaminant plume, it is recommended that nine LTM wells, three POC monitoring wells, and a contingent sampling point be used at the mouth of the stormwater sewer that runs along Cambridge Street and empties into Pond S. Regular sampling and analysis of ground water from the LTM and POC wells will allow sufficient time to implement hydraulic controls to contain the plume if BTEX compounds are detected in the POC wells. These wells should be sampled on a semiannual basis for 13 years. If Federal MCLs are exceeded at the LTM well near the Cambridge Street and Yorktown Street intersection, the contingency sampling point located at the stormwater outfall near Pond 5 must be sampled. If site conditions indicate that the contaminant plume is receding or gone at this time or sooner, sampling can be discontinued. Ground water samples should be analyzed for the analytes described in Section 7 of this report. If BTEX concentrations in ground water in the contingency sampling point or POC wells are found to exceed MCLs, additional corrective actions should be implemented to remediate ground water at the site, as described in this report.

SECTION 9

REFERENCES

- Abdul, S.A., Gibson, T.L., and Rai, D.N., 1987, Statistical Correlations for Predicting the Partition Coefficient for Nonpolar Organic Contaminants Between Aquifer Organic Carbon and Water. *Hazardous Waste and Hazardous Materials*, 4(3):211-222.
- Abdul, A.S., Kia, S.F., and Gibson, T.L., 1989, Limitations of monitoring wells for the detection and quantification of petroleum products in soils and aquifers: *Ground Water Monitoring Review*, Spring, 1989, p. 90-99.
- Anderson, M.P., and Woessner, W.W., 1992, Applied Groundwater Modeling - Simulation of Flow and Advective Transport: *Academic Press*, New York 381 p.
- Ballestero, T.P., Fiedler, F.R., and Kinner, N.E., 1994, An investigation of the relationship between actual and apparent gasoline thickness in a uniform sand aquifer: *Ground Water*, v. 32, no. 5, p. 708-718.
- Barr, K.D., 1993, Enhanced groundwater remediation by bioventing and its simulation by modeling, In Proceedings of the 1993 *Environmental Restoration Technology Transfer Symposium*, January 26-28, Wyndham Hotel, San Antonio, Texas: United States Air Force Center for Environmental Excellence.
- Beller, H.R. Reinhard, M., and Grbic-Galic, D., 1992, Metabolic byproducts of anaerobic toluene degradation by sulfate-reducing enrichment cultures: *Applied Environmental Microbiology*, v. 58, p. 3192-3195.
- Blake, S.B., and Hall, R.A., 1984, Monitoring petroleum spills with wells - some problems and solutions: In *Proceedings of the Fourth National Symposium on Aquifer Restoration and Ground Water Monitoring*: May 23-25, 1984, p. 305-310.
- Bohon, R.L., and Claussen, W.F., 1951, The Solubility of Aromatic Hydrocarbons in Water. *Journal of American Chemical Society*, 73(4):1571-1578.
- Borden, R.C. and P.B. Bedient. 1986. Transport of Dissolved Hydrocarbons Influenced by Oxygen Limited Biodegradation - Theoretical Development. *Water Resources Research*, 22 (13) 1973-1982.
- Bouwer, H., and Rice, R.C., 1976, A Slug Test for Determining Hydraulic Conductivity of Unconfined Aquifers With Completely or Partially Penetrating Wells: *Water Resources Research*, v. 12, no. 3, p. 423-428.

- Bonwer, H., 1989, The Bouwer and Rice slug test - an update: *Ground Water*, v. 27, no. 3, p. 304-309.
- Bouwer, E.J., 1992, Bioremediation of Subsurface Contaminants, In R. Mitchell, editor, *Environmental Microbiology*, Wiley-Liss, New York New York.
- Concawe, 1979, Protection of groundwater from oil pollution; *Den Haag*, Report No. 3M9.
- Cozarelli, I.M., Eganhouse, R.P., and Baedecker, M.J., 1990, Transformation of Monoaromatic Hydrocarbons to Organic Acids in Anoxic Ground Water Environment. *Environmental and Geological Water Science*, 16.
- Davies, J.S., and Westlake, D.W.S., 1979, Crude Oil Utilization by Fungi. *Canadian Journal of Microbiology*, 25:146-156.
- de Pastrovich, T.L., Baradat, Y., Barthel, R., Chiarelli, A., and Fussell, D.R., 1979, Protection of groundwater from oil pollution: *CONCAWE*, The Hague, 61 p.
- Domenico, P.A., and Schwartz, F.W., 1990, Physical and Chemical Hydrogeology: *John Wiley and Sons*, New York 824 p.
- Edwards, E.A., and Grbic-Galic, D., 1992, Complete mineralization of benzene by aquifer microorganisms under strictly anaerobic conditions: *Applied Environmental Microbiology*, v. 58, p. 2663-2666.
- Edwards, E.A., Wells, L.E., Reinhard, M., and Grbic-Galic, D., 1992, Anaerobic degradation of toluene and xylene by aquifer microorganisms under sulfate-reducing conditions: *Applied Environmental Microbiology*, v. 58, p. 794-800.
- Feth, J.H., Barker, D.A., Moore, L.G., and Brown, R.J., and Veirs, C.E., 1966, Lake Bonneville - Geology and Hydrogeology of the Weber Delta District, Including Ogden, Utah: *US Geological Survey Professional Paper 518*, 76 p.
- Freeze, R.A., and Cherry, J.A., 1979, *Ground Water*. Prentice-Hall, Inc., Englewood Cliffs, New Jersey.
- Gemperline, Andrew, 1995, OO-ALC/EMR, personal written communication, Hill Air Force Base, 7276 Wardleigh Road, Utah, 84056-5127.
- Geoprobe Systems®, 1994, Geoprobe GH-40 Soil Probing Hammer Operating Instructions, Technical Bulletin No. 94-040A.
- Goldstein, R.M., Mallory, L.M., and Alexander, M., 1985, Reasons for Possible Failure of Inoculation to Enhance Biodegradation. *Applied Environmental Microbiology*, 50(4):977-983.
- Grbic-Galic, D., and Vogel, T.M., 1987, Transformation of toluene and benzene by mixed methanogenic cultures: *Applied and Environmental Microbiology*, v. 53, p. 254-260.
- Grbic-Galic, D., 1990, Anaerobic microbial transformation of nonoxygenated aromatic and alicyclic compounds in soil, subsurface, and freshwater sediments: In J.M. Bollag and G. Stotzky, editors, *Soil Biochemistry*: Marcel Dekker, Inc., New York, p. 117-189.

- Hall, R.A., Blake, S.B., and Champlin, S.C. Jr., 1984, Determination of hydrocarbon thicknesses in sediments using borehole data: In *Proceedings of the Fourth National Symposium on Aquifer Restoration and Ground Water Monitoring* May 23-25, 1984, p. 300-304.
- Hampton, D.R., and Miller, P.D.G., 1988, Laboratory investigation of the relationship between actual and apparent product thickness in sands:
- Hinchee, R.E., Alleman, B.C., Miller, R.N., and Vogel, C., 1993, Bioventing, In Proceedings of the 1993 *Environmental Restoration Technology Transfer Symposium*, January 26-28, Wyndham Hotel, San Antonio, Texas: United States Air Force Center for Environmental Excellence.
- Hine, J., and Mookerjee, P.K., 1975, The Intrinsic Hydrophilic Character of Organic Compounds. Correlations in Terms of Structural Contributions. *Journal of Organic Chemistry*, 40(3): 292-298.
- Hopper, D.J., 1978, Microbial Degradation of Aromatic Hydrocarbons In R.J. Watkinson (editor), *Developments in Biodegradation of Hydrocarbons, I. Applied Science Publishers, Ltd., London.*
- Hughes, J.P., Sullivan, C.R., and Zinner, R.E., 1988, Two techniques for determining the true hydrocarbon thickness in an unconfined sandy aquifer: In *Proceedings of the Petroleum Hydrocarbons and Organic Chemicals in Ground Water: Prevention, Detection, and Restoration Conference: NWWA/API*, p. 291 -314.
- Hutchins, S.R., 1991, Biodegradation of monoaromatic hydrocarbons by aquifer microorganisms using oxygen, nitrate, or nitrous oxide as the terminal electron acceptor: *Applied Environmental Microbiology*, v. 57, p. 2403-2407.
- Isnard, S., and Lambert, S., 1988, Estimating Bioconcentration Factors from Octanol-Water Partition Coefficient and Aqueous Solubility. *Chemosphere*, 17(1):21-34.
- James M. Montgomery Consulting Engineers, Inc., 1991, *External Draft Site Characterization Report for UST Site 870.0 (AGSS)*, December 1991.
- James M. Montgomery Consulting Engineers, Inc., 1992a, Free Product Recovery Letter Report, UST Site 870.0 (EGSS), November, 1992.
- James M. Montgomery Consulting Engineers, Inc., 1992b, Pumping Tests and Product Thickness Test Letter Report, UST Site 870.0 (EGSS), November, 1992.
- James M. Montgomery Consulting Engineers, Inc., 1993a, Remedial Options Letter Report, January, 1993.
- James M. Montgomery Consulting Engineers, Inc., 1993b, *Draft Investigation Summary Report, UST Site 870*, February, 1993.
- Jamison, V.W., Raymond, R.L., and Hudson, J.O. Jr., 1978, Biodegradation of high-octane gasoline in ground water: *Developments in Industrial Microbiology*, v. 16.

- Jones, J.G., and Eddington, M.A., 1968, An Ecological Survey of Hydrocarbon-Oxidizing Microorganisms. *Journal of General Microbiology*, 52:381-390.
- Jury, W.A., Spencer, W.F., and Farmer, W.J., 1984, Behavior Assessment Model for Trace Organics in Soil: m, Application of Screening Model. *Journal of Environmental Quality*, 13(4):573-579.
- Kemblowski, M.W., and Chiang, C.Y., 1990, Hydrocarbon thickness fluctuations in monitoring wells: *Ground Water* v. 28, no. 2, p. 244-252.
- Konikow, L.F., and Bredehoeft, J.D., 1978, Computer model of two-dimensional solute transport and dispersion in ground water: *United States Geological Survey, Techniques of Water Resources Investigations of the United States Geological Survey*, Book 7, Chapter C2, 90 p.
- Lenhard, R.J., and Parker, J.C., 1990, Estimation of free hydrocarbon volume from fluid levels in monitoring wells: *Ground Water*, v. 28, no. 1, p. 57-67.
- Lovely, D.R., Baedecker, M.J., Lonergan, D.J., Cozarelli, I.M., Phillips, E.J.P., and Siegel, D.I., 1989, Oxidation of aromatic contaminants coupled to microbial iron reduction: *Nature*, v. 339, p. 297-299.
- Lyman, W.J., Reidy, P.J., and Levy, B., 1992, *Mobility and Degradation of Organic Contaminants in Subsurface Environments*. C.K. Smoley, Inc., Chelsea, Michigan.
- Mackay, D., and Wolkoff, A.W., 1973, Rate of Evaporation of Low-Solubility Contaminants from Water Bodies to Atmosphere. *Environmental Science and Technology*, 7(7):611-614.
- Mackay, D., and Shiu, W.Y., 1981, A Critical Review of Henry's Law Constants for Chemicals of Environmental Interest. *Journal of Physical Chemistry Reference Data*, 10(4):1175-1199.
- Martel, 1987, Military Jet Fuels 1944-1987: AF Wright Aeronautical Laboratories, Wright-Patterson Air Force Base, Ohio.
- Mercer, J.W., and Cohen, R.M., 1990, A review of immiscible fluids in the subsurface -properties, models, characterization and remediation: *Journal of Contaminant Hydrology*, v.6, p. 107-163.
- Miller, R.N., Downey, D.C., Carmen, V.A., Hinchee, R.E., and Leeson, A., 1993, A summary of bioventing performance at multiple sites, In Proceedings of the Petroleum Hydrocarbons and Organic Chemicals in Ground Water: *Prevention, Detection, and Restoration Conference*: NWWA/API, p. 397 - 411.
- Miller, M.M., Wasik S.P., Huang, G.L., Shiu, W.Y., and Mackay, D., 1985, Relationships Between Octanol-Water Partition Coefficient and Aqueous Solubility. *Environmental Science and Technology*, 19(6): 522-529.
- Montgomery Watson, Inc., 1994a, Site Monitoring and Product Recovery Progress Letter Report.

- Montgomery Watson, Inc., 1994b, December 1993/January 1994 Quarterly Ground-Water sampling letter.
- Pankow, J.F., and Rosen, M.E., 1988, Determination of Volatile Compounds in Water by Purging Directly to a Capillary Column with Whole Column Cryotrapping. *Environmental Science and Technology*, 22(4): 398-405.
- Perry, J.J., 1984, Microbial Metabolism of Cyclic Alkanes In R.M. Atlas (editor), *Petroleum Microbiology*. Macmillan Publishing Co., New York, New York.
- Ribbons, D.W., and Eaton, R.W., 1992, Chemical Transformations of Aromatic Hydrocarbons that Support the Growth of Microorganisms In Ralph Mitchell (editor), *Environmental Microbiology*. Wiley-Liss, New York New York.
- Rifai, H.S., Bedient, P.B., Wilson, J.T., Miller, K.M., and Armstrong, J.M., 1988, Biodegradation modeling at aviation fuel spill site: *Journal of Environmental Engineering*, v. 114, no. 5, p. 1007-1029.
- Rifai, H.S., 1995, Proceedings of the 3rd Annual Batelle Conference, San Diego, CA, April 1995. (To be published)
- Smith, J.H., Harper, J.C., and Jaber, H., 1981, Analysis and environmental fate of Air Force distillate and high-density fuels: *Engineering & Services Laboratory*, Tyndall Air Force Base, Florida
- Testa, S.M., and Paczkowski, M.T., 1989, Volume determination and recoverability of free hydrocarbon: *Ground Water Monitoring Review*, Winter, 1989, p. 120-128.
- US Environmental Protection Agency, 1991, Role of the Baseline Risk Assessment in Superfund Remedy Selection Decisions. Memorandum from Don R. Clay, Assistant Administrator of the Office of Solid Waste and Emergency Response, OSWER Directive 9355.0-30.
- Valsaraj, K.T., 1988, On the Physio-Chemical Aspects of Partitioning of Non-Polar Hydrophobic Organics at the Air-Water Interface. *Chemosphere*, 17(5):875-887.
- Verschuere, K., 1983, *Handbook of Environmental Data on Organic Chemicals*. Van Nostrand Reinhold Co., New York, New York.
- von Gunten, U., and Zobrist, J., 1993, Biogeochemical changes in groundwater-infiltration systems - Column Studies: *Geochem. Cosmochim Acta*, v.57, p. 3895-3906.
- Walton, W.C., 1988, Practical Aspects of Ground Water Modeling: *National Water Well Association*, Dublin, Ohio, 587 p.
- Wilson, B.H., Smith, G.B., and Rees, J.F., 1986, Biotransformations of Selected Alkylbenzenes and Halogenated Aliphatic Hydrocarbons in Methanogenic Aquifer Material: A Microcosm Study. *Environmental Science and Technology*, 20(10):997-1002.

Wilson, B.H., Wilson, J.T., Kampbell, D.H., Bledsoe, B.E., and Armstrong, J.M., 1990, Biotransformation of Monoaromatic and Chlorinated Hydrocarbons at an Aviation Gasoline Spill Site. *Geomicrobiology Journal* 8:225-240.

Wilson, J.T., 1994, Personal Communication, RE: nitrate-BTEX reactions in ground water, USEPA RSKERL.

Wiedemeier, T.H., Downey, D.C., Wilson, J.T., Kampbell, D.H., Miller, R.N., and Hansen, J.E., 1994, *Draft Technical Protocol for Implementing the Remediation with Long-Term Monitoring Option for Natural Attenuation of Dissolved-Phase Fuel Contamination in Ground Water: Air Force Center for Environmental Excellence, Brooks Air Force Base* Texas.