

# **The Site Characterization and Analysis Penetrometer System (SCAPS) Laser-Induced Fluorescence (LIF) Sensor and Support System**

## **Innovative Technology Verification Report**

by

Grace Bujewski  
Brian Rutherford

Sandia National Laboratories  
Albuquerque, New Mexico

National Exposure Research Laboratory  
Characterization Research Division  
U.S. Environmental Protection Agency  
Las Vegas, Nevada 89193

## **Notice**

The U.S. Environmental Protection Agency (EPA), through its Office of Research and Development (ORD), partially funded and managed the extramural research described here. It has been peer reviewed by the Agency and approved as an EPA publication. Mention of trade names or commercial products does not constitute endorsement or recommendation by EPA for use.







## Foreword

The U.S. Environmental Protection Agency is charged by Congress with protecting the Nation's land, air, and water resources. Under a mandate of national environmental laws, the Agency strives to formulate and implement actions leading to a compatible balance between human activities and the ability of natural systems to support and nurture life. To meet this mandate, EPA's Office of Research and Development (ORD) provides data and science support that can be used to solve environmental problems and to build the scientific knowledge base needed to manage our ecological resources wisely, to understand how pollutants affect our health, and to prevent or reduce environmental risks.

The National Exposure Research Laboratory (NERL), ORD, is the Agency's center for the investigation of technical and management approaches for identifying and quantifying risks to human health and the environment. One focus of the Laboratory's research program is to develop and evaluate technologies for the characterization and monitoring of air, soil, water and subsurface resources. This in turn, will provide the scientific information needed by EPA to support regulatory and policy decisions; and to provide the science support needed to ensure effective implementation of environmental regulations and strategies.

Effective measurement and monitoring technologies are needed to assess the degree of contamination at a site, to provide data which may be used to determine the risk to public health or the environment, to supply the necessary cost and performance data to select the most appropriate technology, and to monitor the success or failure of a remediation process.

Candidate technologies can originate from within the federal government or from the private sector. Through this program, developers are given the opportunity to conduct a rigorous demonstration of their technology's performance under realistic field conditions. By completing the evaluation and distributing the results, the Agency establishes a baseline for acceptance and use of these technologies. The Characterization and Monitoring portion of this program is administered by NERL's Characterization Research Division in Las Vegas, Nevada.

Gary J. Foley, Ph.D.  
Director  
National Exposure Research Laboratory

# Table of Contents

<b><u>Section</u></b>	<b><u>Page</u></b>
Notice .....	ii
Verification Statement .....	iii
Foreword .....	vi
List of Figures .....	x
List of Tables .....	x
List of Abbreviations and Acronyms .....	xi
Acknowledgment .....	xiii
<b>Executive Summary .....</b>	<b>1</b>
Technology Description .....	1
Demonstration Objectives and Approach.....	2
Demonstration Results and Performance Evaluation .....	2
Cost Evaluation .....	3
<b>Introduction .....</b>	<b>4</b>
The Site Characterization Technology Challenge.....	4
Technology Demonstration Process .....	4
Technology Selection .....	4
Technology Demonstration.....	5
Technology Performance Assessment, Evaluation, and Verification.....	5
Information Distribution .....	6
The CPT-LIF Sensor Demonstrations .....	6
<b>SCAPS LIF Technology Description.....</b>	<b>7</b>
LIF Sensing Technologies .....	7
The Cone Penetrometer Platform .....	7
Cone Penetrometer LIF Probe .....	8
Laser Source .....	9
Detection System .....	9
Noise, Background, and Sensitivity.....	9
Calculated Fluorescence Threshold and Detection Threshold .....	10
Dynamic Range.....	11
Technology Applications.....	11
Advantages of the Technology .....	11
Limits of the Technology .....	11
Truck-Mounted Cone Penetrometer Access Limits.....	12
Cone Penetrometer Advancement Limits .....	12
Response to Different Petroleum Hydrocarbons .....	12
Matrix Effects .....	12
Spectral Interferences .....	13
Technology Deployment and Costs.....	14

<b>Reference Laboratory Results and Evaluation .....</b>	<b>15</b>
Selection of Reference Laboratory and Methods .....	15
Assessment of Laboratory Data Quality .....	16
Audits .....	16
Sample Holding Times .....	16
Sample Preparation .....	16
Sample Analysis.....	16
Detection Limits .....	17
Quality Control Procedures .....	17
Accuracy, Precision, and Completeness .....	17
Use of Qualified Data for Statistical Analysis .....	19
<b>Demonstration Design and Description.....</b>	<b>20</b>
Evaluation of SCAPS LIF Sensor Performance .....	20
Evaluation of SCAPS CPT Platform Performance .....	20
Description of Demonstration Sites .....	20
Port Hueneme Site Description.....	21
Demonstration Sampling Operations, Port Hueneme.....	23
Port Hueneme Sampling Locations .....	25
SNL Tank Farm Site Description .....	26
Demonstration Sampling Operations, SNL Tank Farm .....	28
Calibration Procedures, Quality Control Checks, and Corrective Action.....	29
SCAPS LIF Initial Calibration Procedures .....	30
SCAPS LIF Continuing Calibration Procedures.....	30
Method Blanks .....	31
Spike Samples .....	31
Instrument Check Standards .....	31
Performance Evaluation Materials.....	31
Duplicate Samples .....	31
Equipment Rinsate Samples .....	31
Data Reporting, Reduction, and Verification Steps .....	31
Data Reporting .....	32
Data Reduction and Verification Steps for the SCAPS LIF Data .....	32
Changes to the Demonstration Plan .....	33
<b>Technology Results and Evaluation .....</b>	<b>34</b>
Developer Claims Presented.....	34
Technology Data Quality Assessment.....	35
Accuracy .....	35
Precision.....	38
Completeness .....	38
Port Hueneme Site Data Presentation and Results .....	38
Port Hueneme Detection Limit .....	39
Downhole Results for Port Hueneme .....	40
Port Hueneme Subsurface Contaminant Mapping.....	40
SNL Tank Farm Site Data Presentation and Results.....	45
SNL Tank Farm Detection Limit.....	45



Downhole Results for SNL Tank Farm .....	48
SNL Tank Farm Subsurface Contaminant Mapping .....	51
Geotechnical Data Assessment.....	52
Overall Performance Evaluation .....	52
Cost Evaluation.....	52
<b>Applications Assessment.....</b>	<b>56</b>
Advantages of the Technology .....	56
Real-Time Analysis .....	56
Continuous LIF Data Output .....	56
Continuous Lithological Logging.....	56
Cost Advantages .....	57
Enhanced Operator Safety .....	57
Performance Advantages .....	57
Limitations of the Technology .....	58
Applicability .....	58
Quantitation and Speciation.....	58
Push Limitations .....	59
Interferences.....	59
Conclusions .....	59
<b>Developer Forum.....</b>	<b>60</b>
Xenon Chloride Laser.....	60
Microchip Laser.....	60
Video Microscope .....	60
Time Domain Reflectometry .....	61
Raman Spectroscopy .....	61
Laser-Induced Breakdown Spectroscopy .....	61
Other Applied Research .....	61
<b>Previous Field Trials .....</b>	<b>62</b>
<b>References .....</b>	<b>64</b>
<b>Appendices.....</b>	<b>66</b>
Appendix A: Reference Laboratory Data.....	66
Appendix B: SCAPS LIF Field Data Logs.....	73
Appendix C: SCAPS LIF Draft EMMC Method .....	74

## List of Figures

<b><u>Figure</u></b>	<b><u>Page</u></b>
3-1 Schematic diagram of SCAPS LIF System.....	8
5-1 Site vicinity map, Port Hueneme .....	22
5-2 Demonstration site and sampling locations, Port Hueneme .....	24
5-3 Site vicinity map, SNL Tank Farm .....	27
5-4 Demonstration site and sampling locations, SNL Tank Farm .....	27
6-1 Schematic of the four possible LIF and TRPH/TPH data categories .....	37
6-2 Plot of results of comparison of Port Hueneme LIF data with laboratory data .....	39
6-3 Downhole results for Port Hueneme.....	41
6-4 Adjusted downhole results for Port Hueneme .....	43
6-5 Cross-sectional map of transect near Tank 5114 at Port Hueneme .....	45
6-6 Plot of results of comparison of SNL LIF data with laboratory data.....	46
6-7 Normalized spectra showing two distinct clusters.....	49
6-8 Downhole results for SNL Tank Farm.....	50
6-9 Subsurface contaminant map for SNL Tank Farm .....	51

## List of Tables

<b><u>Table</u></b>	<b><u>Page</u></b>
4-1 Quality Control Results for TPH .....	18
4-2 Quality Control Results for TRPH.....	18
5-1 Port Hueneme Boring and Push Summary Table.....	26
5-2 SNL Tank Farm Boring and Push Summary Table .....	29
6-1 Summary of comparison of results for Port Hueneme Demonstration .....	37
6-2 Summary of comparison of unadjusted results for SNL Demonstration .....	47
6-3 Summary of comparison of adjusted results for SNL Demonstration .....	47
6-4 LIF sensor claims evaluation .....	53
6-5 SCAPS CPT claims evaluation .....	54
6-6 Relative costs for the SCAPS LIF system.....	55
7-1 Performance statistics .....	58

## List of Abbreviations and Acronyms

AEC	Army Environmental Center
ASTM	American Society for Testing and Materials
ATI	Analytical Technologies, Inc.
bbl	Barrel (Equivalent to 42 U.S. Gallons)
bgs	Below Ground Surface
cm	Centimeter
CAS	Chemical Abstracts Service
CPT	Cone Penetrometer Testing
CSCT	Consortium for Site Characterization Technology
DFM	Diesel Fuel Marine
DHS	Department of Health Services (California)
DoD	Department of Defense
DOE	Department of Energy
DOT	Department of Transportation
DQO	Data Quality Objective
EDM	Engineering Development Model
EMMC	Environmental Monitoring Management Council
EPA	U. S. Environmental Protection Agency
ETI	Environmental Technology Initiative
ETV	Environmental Technology Verification Program
ft	Feet
FVD	Fluorescence Versus Depth
GC/FID	Gas Chromatograph/Flame Ionization Detector
HASP	Health and Safety Plan
HNTS	Hydrocarbon National Test Site
HSA	Hollow Stem Auger
Hz	Hertz
IDW	Investigation Derived Waste
IR	Infrared
IRP	Installation Restoration Program
ITVR	Innovative Technology Verification Report
LIF	Laser-Induced Fluorescence
m	Meter
m/min	Meters per Minute
µm	Micrometer
mg/kg	Milligrams per Kilogram
mg/L	Milligrams per Liter

## List of Abbreviations and Acronyms (Continued)

mJ	Millijoules
mL	Milliliter
mm	Millimeter
MS	Matrix Spike
MSD	Matrix Spike Duplicate
ms	Millisecond
msl	Mean Sea Level
NCBC	Naval Construction Battalion Center
NCCOSC RDT&E	Naval Command, Control, and Ocean Surveillance Center Research, Development, Test, and Evaluation (Division)
NERL-CRD	National Exposure Research Laboratory-Characterization Research Division
nm	Nanometer
NRaD	Unofficial Shorthand Abbreviation for NCCOSC RDT&E Division
ns	Nanosecond
PAH	Polycyclic Aromatic Hydrocarbons
PDA	Photodiode Array
PE	Performance Evaluation
PPE	Personal Protective Equipment
ppm	Parts per Million
PRC	PRC Environmental Management, Inc.
QA	Quality Assurance
QAPP	Quality Assurance Project Plan
QC	Quality Control
R <sup>2</sup>	Correlation Coefficient
RI/FS	Remedial Investigation/Feasibility Studies
RPD	Relative Percent Difference
SCAPS	Site Characterization and Analysis Penetrometer System
SNL	Sandia National Laboratories (Department of Energy)
SOP	Standard Operating Procedure
SPT	Standard Penetrometer Testing
TER	Technology Evaluation Report
TPH	Total Petroleum Hydrocarbons
TRPH	Total Recoverable Petroleum Hydrocarbons
TSF	Ton/ft <sup>2</sup>
U.S.	United States
USCS	Unified Soil Classification System
UV	Ultraviolet
WES	Waterways Experimental Station (Army Corps of Engineers)

## **Acknowledgment**

We wish to acknowledge the support of all those who helped plan and conduct the demonstrations, interpret data, and prepare this report. In particular, for demonstration site access and relevant background information, Stephan McCarel and Ernest Lory (Naval Facilities Engineering Service Center), and David Miller (SNL); for implementation of the demonstration plan and data evaluation, Grace Bujewski, Brian Rutherford, Dr. Robert Knowlton, and Robert Helgesen (SNL) and Peter Stang (PRC); for logistical and health and safety support, Michael Skelly (Roy F. Weston, Inc.) and Michael Strosinsky (SNL); for editorial and publication support, Merlyn Liberty (Tech Repts, Inc.); for peer and technical reviews, Jerry Peace (SNL), Dr. Bruce LaBelle (State of California Environmental Protection Agency, Department of Toxic Substances Control), and Dr. Robert Lien (U.S. EPA); and for U.S. EPA project management, Dr. Stephen Billets and Dr. Robert Lien (U.S. EPA). In addition, we gratefully acknowledge the participation of the SCAPS LIF technology developers, Dr. Stephen Lieberman, Dr. David Knowles, and Mr. Thomas Hampton (U.S. Navy NCCOSC RDT&E Division) and Mr. George Robitaille (Tri-Services SCAPS Program of the U.S. Army Environmental Center), (619) 553-1172 and (410) 612-6865, respectively.

## Section 1

### Executive Summary

The Consortium for Site Characterization Technology (CSCT) has established a formal program to accelerate acceptance and application of innovative monitoring and site characterization technologies that improve the way the nation manages its environmental problems. The CSCT is a partnership program involving the U.S. Environmental Protection Agency (EPA), the Department of Defense (DoD), and the Department of Energy (DOE). Its mission is to support the demonstration and verify the performance of new and emerging technologies.

In 1995 the CSCT conducted a demonstration of two *in situ* laser-induced fluorescence-based technologies using the Site Characterization and Analysis Penetrometer System (SCAPS) cone penetrometer testing (CPT) platform. The two technologies were the SCAPS LIF, developed through a collaborative effort of the Army, Navy, and Air Force under the Tri-Services SCAPS program and by the Naval Command, Control, and Ocean Surveillance Center, Research, Development Test, and Evaluation (NCCOSC RDT&E) Division, and the Rapid Optical Screening Tool™ developed by Loral Corporation and Dakota Technologies, Inc. These technologies were designed to provide rapid sampling and real time, relatively low cost analysis of the physical and chemical characteristics of subsurface soil to distinguish contaminated and noncontaminated areas. Results for the Rapid Optical Screening Tool technology are presented in a separate report.

The purpose of this Innovative Technology Verification Report (ITVR) is to document the demonstration activities, present and evaluate the demonstration data in order to verify the performance of the SCAPS LIF sensing technology relative to developer claims.

#### ***Technology Description***

The SCAPS LIF system uses a pulsed laser coupled with an optical detector to measure fluorescence via optical fibers. The measurement is made through a sapphire window on a probe that is pushed into the ground with a truck-mounted cone penetrometer. The CPT platform and standard penetrometer testing (SPT) have been widely used in the geotechnical industry for determining soil strength and soil type from measurements of tip resistance and sleeve friction on an instrumented probe. The LIF technology demonstrated was a nitrogen laser-based LIF sensor and support system currently being used in the Navy, Army, and DOE (developed by the Navy's NCCOSC RDT&E Division in collaboration with the Army's Waterways Experimental Station and Army Environmental Center [AEC]), using the SCAPS CPT platform.

The LIF method provides data on the *in situ* distribution of petroleum hydrocarbons based on the fluorescence response induced in the polycyclic aromatic hydrocarbon (PAH) compounds that are components of petroleum hydrocarbons. PAHs in petroleum products are induced to fluoresce by excitation with UV light. The method provides a "detect/nondetect" field screening capability relative to a detection limit derived for a specific fuel product on a site-specific soil matrix. The SCAPS LIF is primarily used as a field screening, qualitative method but can be semi-quantitative at concentrations within two orders of magnitude of its detection limit for fluorescent petroleum hydrocarbons.

## ***Demonstration Objectives and Approach***

The primary objectives of the field demonstrations were to evaluate the SCAPS LIF technology in the following areas: (1) its performance compared to conventional sampling and analytical methods; (2) the logistical resources necessary to operate the technology; (3) the quality of the LIF data; (4) the applications of the technology as determined by its performance in the CSCT demonstrations; and (5) its performance relative to developer claims. Performance of the SCAPS LIF was evaluated to determine the agreement between LIF "detect/nondetect" data and laboratory analyses for both total recoverable petroleum hydrocarbons by EPA Method 418.1 and total petroleum hydrocarbons by California Department of Health Services Method 8015-modified. A secondary objective for this demonstration was to evaluate the LIF technology for cost, range of usefulness, and ease of operation.

In the approved demonstration plan, the developers presented several performance claims against which they were evaluated. These claims may be separated into two groups: claims for the LIF sensor and claims for the SCAPS CPT platform. The claims regarding the capabilities and performance of the sensor included the percentage agreement between LIF detect/nondetect data and laboratory reference method results, sample collection rates, ability to produce a site-specific detection threshold in concentration units, ability to store spectral signatures, ability to distinguish different classes of hydrocarbon products, ability to assist in real-time decision making as part of a field sampling event, and ability to detect hydrocarbons in the vadose zone, capillary fringe, and saturated zones. The claims regarding the capabilities and performance of the SCAPS CPT platform included push rates, ability to collect simultaneous continuous geotechnical and stratigraphic information, ability to minimize contaminating or altering soil samples, ability to measure depth more accurately than with conventional methods of drilling and sampling, and the production of minimal amounts of investigation-derived waste.

The demonstration was designed to evaluate the LIF technology as a field screening method by comparing LIF data to data produced by conventional sampling and analytical methods. For both demonstrations, conventional sampling and analysis consisted of boring with a hollow stem auger, collecting split spoon samples as closely as possible to the push cavity, and analyzing discrete samples at an off-site commercial laboratory for petroleum hydrocarbons by EPA Method 418.1 and California Department of Health Services Method 8015-modified. The demonstrations were conducted at two geologically and climatologically different sites: (1) the Hydrocarbon National Test Site located at Naval Construction Battalion Center (NCBC), Port Hueneme, California, in May 1995, and (2) the Steam Plant Tank Farm at Sandia National Laboratories (SNL), Albuquerque, New Mexico, in November 1995.

## ***Demonstration Results and Performance Evaluation***

The LIF technology demonstrated using the SCAPS CPT platform provided real-time field screening of the physical characteristics of soil and chemical characteristics of petroleum hydrocarbon contamination at both demonstration locations. The system was able to quickly distinguish contaminated and uncontaminated areas when compared to conventional sampling and analysis technologies.

The results of the demonstration indicate that the performance claims of the SCAPS LIF sensing technology were met. Specifically, at both sites the SCAPS LIF technology produced comparable results to the reference methods, with better than 90 percent agreement with discrete soil sample analytical results. During the field tests the SCAPS cone penetrometer encountered some difficulties in pushing through gravel and cobble lithologies at both sites. In addition, the LIF technology produced a significant number of positive responses at the SNL Tank Farm site due to fluorescing minerals in the soil. However, these nonhydrocarbon fluorescent minerals were easily identified in the field and confirmed in post-demonstration processing of the LIF data. Based on this evaluation, the SCAPS LIF

technology appears to be capable of rapidly and reliably mapping the relative magnitude of the vertical and horizontal extent of subsurface fluorescent petroleum hydrocarbon contaminant plumes in soil and groundwater.

### ***Cost Evaluation***

The SCAPS technology is designed to be operated by trained technicians from the AEC, U.S. Navy, or other licensees. It is not available for use by private citizens or corporations, but is available to state and federal agencies. The estimated cost of sampling using the SCAPS LIF system varies between \$12 and \$20 per foot depending upon whether the operators provide a turnkey operation or the customer provides field deployment assistance such as permitting, site management, and development of work and health and safety plans. Under normal conditions, 200 feet of pushes can be advanced per day. Concrete coring, grouting, permit fees, and distant travel costs or mobilization/demobilization costs vary with each deployment and thus are not included. This compares to conventional drilling costs, which range between \$15 and \$20 per foot for drilling and installation of monitoring wells and between \$50 and \$100 per foot for drilling and sampling for site characterization. In addition, laboratory analysis costs, which range from \$90 to \$150 per sample for TPH or TRPH, must also be considered.

The main savings attributable to the SCAPS LIF system is that it can substantially reduce the number of monitoring wells drilled at a site. In a general site characterization effort, it can provide data in less time and far less expensively than conventional drilling and sampling. Investigation-derived wastes are minimal, and worker exposure to contaminants is reduced when using *in situ* technologies rather than conventional drilling and sampling methods.



## Section 2

### Introduction

#### ***The Site Characterization Technology Challenge***

Rapid, reliable and cost effective field screening technologies are needed to assist in the complex task of characterizing and monitoring of hazardous and chemical waste sites. However, some environmental regulators and remediation site managers may be reluctant to use new site characterization technologies that have not been validated in an EPA-sanctioned testing program, since data from them may not be admissible in potential legal proceedings associated with a site or its cleanup. Until characterization technology claims can be verified through an unbiased evaluation, the user community will remain skeptical of innovative technologies, despite their promise of better, less expensive and faster environmental analyses.

The Consortium for Site Characterization Technology was established as a component of the Environmental Technology Innovation, Commercialization and Enhancement Program as outlined in 1993 in President Clinton's Environmental Technology Initiative to specifically address these concerns. The CSCT is a partnership between the EPA, the Department of Energy, and the Department of Defense. As a partnership, the CSCT offers valuable expertise to support the demonstration of new and emerging technologies. Through its organizational structure, it provides a formal mechanism for independent third-party assessment, evaluation, and verification of emerging site characterization technologies.

The mission of the CSCT is to identify, demonstrate, assess, and disseminate information about innovative and alternative environmental monitoring, measurement, and characterization technologies to developers, remediation site managers, and regulators. The Consortium is intended to be a principal source of information and support with respect to the availability, maturity, and performance of innovative environmental monitoring, measurement, and characterization technologies.

#### ***Technology Demonstration Process***

The CSCT provides technology developers a clearly defined performance assessment, evaluation and verification pathway. The pathway is outlined in the following four components:

- technology selection;
- technology demonstration;
- technology performance assessment, evaluation, and verification, and
- information distribution.

These are discussed in more detail in the following paragraphs.

#### **Technology Selection**

The first step in the overall demonstration process is one of technology selection. The selection process comprises two components. Beyond the initial identification of potential technologies, a critical aspect of technology selection is an assessment of its *field deployment readiness*. Only pre-production and production instrumentation with a history of successful laboratory or field operation are accepted into the program. Early, unproven prototype instrumentation systems requiring extensive testing and modifi-

cation prior to field deployment are not acceptable demonstration candidates. The candidate technology must meet minimum technology maturity criteria in order to participate in a demonstration. The degree of technology maturity may be described by one of three levels:

**Level 1**

Technology has been demonstrated in a laboratory environment and ready for initial field trials.

**Level 2**

Technology has been demonstrated in a laboratory environment and in field trials.

**Level 3**

Technology has been demonstrated extensively both in the laboratory and in field trials and is commercially available.

A second aspect of the technology selection process involves a determination of *technology/field requirements match*. Because of limited resources, the Consortium must determine a technology's suitability for demonstration in light of the current needs of the environmental characterization and monitoring community. A technology may be given priority for demonstration and evaluation based on its environmental and fiscal impact and the likelihood that its demonstration will fill information gaps which currently impede cost effective and efficient environmental problem solving. The CSCT conducts surveys of EPA, DOE, DoD, state, local, tribal and industry agencies to assist in determining the degree of match between the candidate technology and the needs of the environmental restoration community.

### **Technology Demonstration**

A technology demonstration plan is developed by the technology verification entity, according to document preparation guidance provided by the Consortium for Site Characterization Technology (CSCT). The demonstration plan includes a technology description, the experimental design, sampling and analysis plan, methods for evaluating the technology, a quality assurance project plan, and a health and safety plan. After approval by the EPA and technology developers, the demonstration plan is implemented at an appropriate field location. The CSCT provides technical support to the technology developer during demonstration plan preparation and execution and also audits the demonstration and data collection processes.

### **Technology Performance Assessment, Evaluation, and Verification**

In this important component of the demonstration process, an objective comparison of demonstration technology data is carried out against a reference data set generated using conventional analysis methodologies. The principal product of this phase of the project is the ITVR, prepared by an independent third party. The report documents the demonstration technology data along with an assessment of the technology's performance in light of the reference data. The degree of data analysis in the technology report is determined by the level of maturity of the technology under evaluation, with the more mature technologies receiving more thorough analysis. The CSCT provides Level 1 technologies with a fielding opportunity in which the system can be tested. Evaluation of the system performance and comparison of field data with reference laboratory data are the developer's responsibility. In the case of Level 2 technologies, the performance evaluation is performed by the CSCT. The most extensive evaluation is done for the Level 3 technologies since these are considered market-ready. As part of the demonstration objectives, the CSCT evaluates the developer claims regarding the capabilities of the Level 3 technology and prepares a technology evaluation report containing an assessment of the technology's performance.

## **Information Distribution**

Evaluation reports for Level 2 technologies are distributed to the developers, CSCT partners and the general public. In addition, Level 3 technology performance verification statements are distributed to the developers for their subsequent use in seeking additional funding or marketing.

Reports for Level 1 technologies contain the field results and laboratory reference data. No evaluation or verification is conducted. The developer or reader may reach their own conclusions as to the performance of the technology.

## ***The CPT-LIF Sensor Demonstrations***

The developer of the SCAPS LIF technology is the NCCOSC RDT&E Division. The NCCOSC RDT&E Division and its contractor, PRC Environmental Management Inc. (PRC) prepared the demonstration plan and conducted the predemonstration and demonstration field efforts, coordinated the analyses of the soil samples, and provided the raw data to Sandia National Laboratories-New Mexico (SNL), a DOE-owned laboratory operated by Lockheed Martin Corporation. SNL, as the EPA's verification entity, reviewed and approved the demonstration plan and amendments and reduced and analyzed the data generated during the two field demonstrations.

The SCAPS LIF is a CSCT Level 3 technology. For these demonstrations, the CSCT worked with the State of California Environmental Protection Agency Department of Toxic Substances Control (Cal EPA-DTSC), to evaluate the SCAPS LIF technology as a field screening tool for detection of petroleum hydrocarbons in the subsurface. Representatives of the Consortium, Cal EPA-DTSC, and developers selected the demonstration sites, participated in the demonstration planning process, and jointly and separately evaluated the data generated during both demonstrations.

This report describes how the demonstration participants collected and analyzed samples, provides the results of the demonstration, and describes how the performance of the SCAPS LIF technology was verified. Section 3 discusses the experimental design for the demonstration. Section 4 presents the reference laboratory results and evaluation. Section 5 describes the SCAPS LIF technology. Section 6 presents the SCAPS LIF demonstration results and evaluation. Section 7 is an assessment of recommended applications of the technology. Section 8 is a forum wherein the developer has the opportunity to discuss the technology results and comment on the evaluation and future developments. Section 9 is a presentation of previous field trials of the SCAPS LIF technology. In addition, there are appendices containing the reference laboratory data, SCAPS LIF data, and proposed SCAPS LIF method.

## Section 3

### SCAPS LIF Technology Description

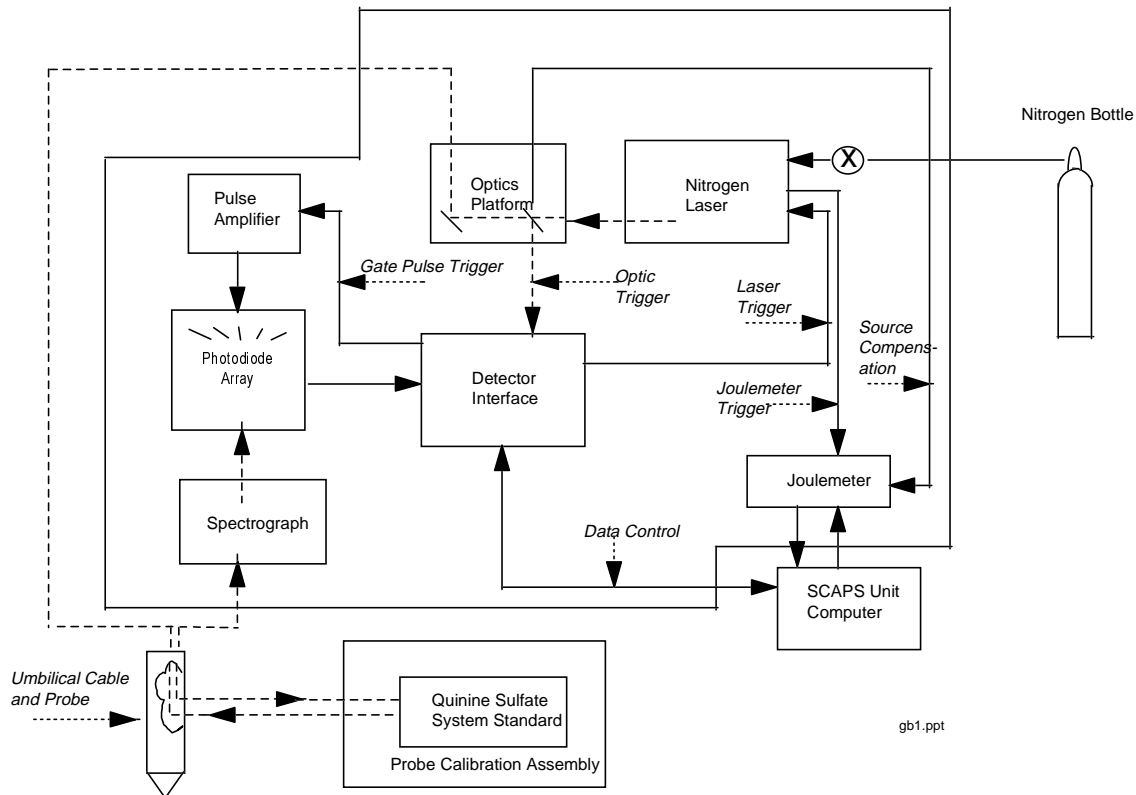
The description of the SCAPS LIF technology and verification of its performance has been divided into two sections, Section 3 and Section 6. Because this is an innovative technology, evaluating its performance and comparing it to conventional laboratory methods with well-established procedures is not as simple as the evaluation of the laboratory methods as presented in the preceding section. Section 3 describes the SCAPS LIF sensor technology developed by NCCOSC RDT&E Division and includes background information and a description of the equipment. General operating procedures, training and maintenance requirements, and some preliminary information regarding the costs associated with the technologies are also discussed. Much of this information was provided by the technology developer and presented in the demonstration plan. Any claims made in this section may or may not have been verified during this demonstration. Specifically, the subsections regarding technology applications and limitations and advantages of the technology were provided by the developer and may not have been verified. The verification of technology performance at the two demonstration sites and evaluation of developer claims for this program are presented in detail in Section 6.

#### ***LIF Sensing Technologies***

The SCAPS CPT is the platform for a family of new rapid field screening technologies for surficial and subsurface contaminants. The LIF technology demonstrated is the nitrogen laser-based LIF sensor and support system currently being used by the Navy and Army (developed and provided by NCCOSC RDT&E Division and Army WES) and supported by the SCAPS CPT platform. The LIF system uses a pulsed laser coupled with an optical detector to make fluorescence measurements via optical fibers. The measurement is made through a sapphire window on a probe that is pushed into the ground with a truck-mounted cone penetrometer. Figure 3-1 is a schematic drawing of the SCAPS LIF system.

#### **The Cone Penetrometer Platform**

CPT and standard penetrometer testing have been widely used in the geotechnical industry for determining soil strength and soil type from measurements of tip resistance and sleeve friction on an instrumented probe. The SCAPS uses a truck-mounted CPT platform to advance its chemical and geotechnical sensing probe. The CPT platform provides a 20-ton static reaction force associated with the weight of the truck. The forward portion of the truck-mounted laboratory is the push room. It contains the rods, hydraulic rams, and associated system controllers. Underneath the SCAPS CPT push room is the steam manifold for the rod and probe decontamination system. The rear portion of the truck-mounted laboratory is the isolatable data collection room in which components of the LIF system and onboard computers are located. The combination of reaction mass and hydraulics can advance a 1-meter long by 3.57-cm diameter threaded-end rod into the ground at a rate of 1 m/min in accordance with ASTM Method D3441, the standard for CPT. The rods, sensing probes, and sampling tools can be advanced to depths in excess of 50 meters in soil. As the rods are withdrawn, grout can be injected through 1/4-inch diameter tubing within the interior of the SCAPS LIF umbilical, hydraulically sealing the push hole. The platform is fitted with a self-contained decontamination system that allows the rods and probe to be steam cleaned as they are withdrawn from the push hole, through the steam cleaning manifold, and back into the CPT push room.



**Figure 3-1. Schematic diagram of SCAPS LIF System.**

In addition to chemical sensors, a number of additional sensors provide valuable information relevant to subsurface characteristics. Groundwater, soil, and soil-gas sampling tools can be used with the CPT. Groundwater sampling tools can vary from a slotted well-point design to a retractable well screen. Soil sampling is accomplished with core-type samplers. Soil-gas sampling is typically accomplished by allowing subsurface vapors to equilibrate in Teflon tubing within the rods. The soil gas is then either collected for delivery to an off-site laboratory or analyzed by an on-board gas chromatograph. These tools were not used in the EPA CSCT demonstrations. Existing CPT systems do not allow *in situ* sampling tools and subsurface sensors to be used concurrently.

### **Cone Penetrometer LIF Probe**

The lead probe rod can be fitted with various types of sampling tools and sensors. The CPT LIF systems use a steel probe containing the LIF sapphire optical window and cone and sleeve strain gauges. The excitation and emission optical fibers are isolated from the soil system by a 6.35 millimeter (mm) diameter sapphire window located 60 cm from the probe tip, mounted flush with the outside of the probe. The SCAPS LIF fibers are 500  $\mu\text{m}$  in diameter and up to 100 m in length.

## Laser Source

The SCAPS LIF pulsed laser fiber optic-based system uses 337-nm ultraviolet light from a pulsed nitrogen laser with a 0.8-ns pulse width and a pulse energy of 1.4 mJ. The nitrogen laser is coupled to a silica-clad ultraviolet/visible light transmitting optical fiber. This fiber and the collection fiber are integrated with the geotechnical probe and umbilical of a standard truck-mounted CPT system.

## Detection System

The SCAPS LIF system uses a pulsed laser fiberoptic-based sensor. As the pulse from the laser is launched into the excitation fiber, a photodiode is triggered which generates a synchronization pulse that is fed into a pulse delay generator. The pulse from this apparatus is used to gate a photodiode array (PDA) detector. Fluorescence stimulated in the *in situ* soil "sample" by the laser is collected by the emission fiber and returned to a spectrograph, where it is dispersed spectrally on the PDA. This arrangement allows for the rapid acquisition of spectral data. Readout of a fluorescence emission spectrum, performed by an EG&G PARC Model 1460 optical multichannel analyzer, requires approximately 16 ms. For a laser firing at a rate of 20 Hz, an entire fluorescence emission spectrum measurement, composed of the average of responses from 20 laser firings, can be collected in approximately 1 second.

Under normal operating conditions, fluorescence emission spectra are collected once per second as the penetrometer probe is pushed into the ground at a rate of approximately 1 m/min. This yields a measurement with a vertical spatial resolution of approximately 0.2 feet. A host computer equipped with custom software controls the fiber optic fluorometer sensor system and stores fluorescence emission spectra and conventional CPT sleeve friction and tip resistance data. The host computer is also used to generate real-time depth plots of fluorescent intensity at the spectral peak, wavelength of spectral peak, sleeve friction and tip resistance, and soil type characteristics as interpreted from the strain gauge data. The fluorescent intensity in the spectral window is plotted as a function of depth in real time as the probe is pushed into the soil. The entire fluorescent emission spectrum is stored on a fixed hard disk to facilitate post-processing of the data. Data logs from both field demonstrations are presented in Appendix B.

## Noise, Background, and Sensitivity

Three quantities are needed to determine the fluorescence threshold and the detection limit for a specific site: noise, background, and sensitivity. For normal field operations, these quantities are determined using the calibration samples prepared immediately prior to the site visit using soil from the site and standard analytical techniques.

The fluorescence intensity for each calibration sample is measured in triplicate daily at the start of operations. The three measurements are averaged to provide a single measured intensity for each concentration. A regression analysis is performed wherein the slope and intercept for this restricted range of operations are estimated. The estimates are:

*intercept* = *b* = estimated fluorescence intensity for a 0 mg/kg calibration sample; and

*slope* = *m* = estimated increase in fluorescence intensity per increase in contaminant concentration

This procedure is carried out using only the lower concentration calibration standards. For example, when using diesel fuel marine (DFM) as the target fuel, the standards will typically consist of samples with concentrations of 0 mg/kg, 500 mg/kg, 1000 mg/kg, 1500 mg/kg and 2000 mg/kg. Experiments have shown that for the full range of calibration standards (up to 100,000 mg/kg), the calibration data does not lend itself well to a linear regression. By restricting the data set to low concentration samples, the data appear to be adequately represented using linear regression.

For the calibration soil samples,  $x_i$  is given by the concentration of the target fuel, while  $y_i$  is the measured fluorescence intensity of the sample, adjusted by the normalization factor described in Section 5. The linear model provides an estimated fluorescence value  $y$  for any given concentration  $x$ , calculated as  $y = b + mx$ .

The residuals are the difference between the data and the fit ( $y_i - (b + mx_i)$ ).

The residual variance  $s^2$  in the regression is estimated by:

$$s^2 = \frac{\sum_{i=1}^n (y_i - (b + mx_i))^2}{n - 2};$$

where  $n$  is the number of measurements and the standard deviation  $s$  of the fit is estimated by the square root of this quantity.

The sensitivity and background are defined as follows:

$$\begin{aligned} \text{sensitivity} &= \text{slope of fitted data} = m; \\ \text{background} &= \text{intercept of fitted data} = b; \text{ and} \\ \text{noise} &= \text{standard deviation of the fit} = s. \end{aligned}$$

### Calculated Fluorescence Threshold and Detection Threshold

The quantities needed to calculate the SCAPS LIF fluorescence threshold and the detection threshold are estimated using quantities described in the previous paragraphs.

$$\begin{aligned} \text{fluorescence threshold} &= \text{background} + \text{noise} \\ &= b + s \end{aligned}$$

$$\begin{aligned} \text{detection threshold} &= \text{noise} / \text{sensitivity} \\ &= s / m \end{aligned}$$

The fluorescence threshold is the quantitative limit that the fluorescence intensity must exceed in order to qualify as a "detect." If the fluorescence intensity is less than the fluorescence threshold, the sensor indicates "nondetect." The detection threshold is the amount of contaminant (based on the calibration performed with the target fuel) that corresponds to the fluorescence threshold. This is the practical detection level in mg/kg as determined from the calibration standards for a given site and on a given day. If the laboratory results indicate contamination levels lower than the LIF detection threshold, the result is classified as a nondetect.

Based on the results calculated for the sites up to this time, the SCAPS LIF detection threshold will vary somewhat from site to site and day to day, but is approximately 100 to 300 mg/kg as TRPH by EPA Method 418.1.

### **Dynamic Range**

The linear dynamic range of the LIF detector depends on the specific hydrocarbon analyte as well as the particular matrix. Generally, for *in situ* measurements, it has been found that the linear portion of the response curves extends well beyond three orders of magnitude. Nonlinearity tends to occur at concentrations greater than 10,000 mg/kg. In sandy soils, the non-linearity occurs at lower concentrations than in clay rich soils, possibly due to self absorption or saturation. The linear dynamic range of the LIF sensor also depends on operator-controlled instrumental parameters. For example, the linear dynamic range may be extended to higher concentrations by adjusting the slit width of the detector, but this results in decreased sensitivity at lower concentrations.

### **Technology Applications**

The NCCOSC RDT&E Division SCAPS LIF system was developed in response to the need for real-time *in situ* measurements of subsurface contamination at hazardous waste sites. The LIF system performs rapid field screening to determine either the presence or absence of petroleum hydrocarbon contaminants within the subsurface of the site. The site can be further characterized with limited numbers of carefully placed borings or wells. In addition, remediation efforts can be directed on an expedited basis as a result of the immediate availability of the LIF and soil matrix data.

### **Advantages of the Technology**

The LIF sensing technology is an *in situ* field screening technique for characterizing the subsurface distribution of petroleum hydrocarbon contamination before installing groundwater monitoring wells or soil borings. The method is not intended to be a complete replacement for traditional soil borings and monitoring wells, but is a means of more accurately placing a reduced number of borings and monitoring wells in order to achieve an adequate site characterization at a reduced cost.

The current configuration is designed to quickly and cost-effectively distinguish petroleum hydrocarbon-contaminated areas from uncontaminated areas. This capability allows further investigation and remediation decisions to be made more efficiently and reduces the number of samples that must be submitted to laboratories for costly analysis. In addition, the SCAPS CPT platform allows for the characterization of contaminated sites with minimal exposure of site personnel and the community to toxic contaminants, and minimizes the volume of investigation derived waste (IDW) generated during typical site characterization activities.

### **Limits of the Technology**

This section discusses the limitations of the SCAPS LIF technology as they are currently understood. These limitations are not restricted to possible accuracy limitations when compared to the reference methods but include differences that might be compared to an ideal contaminant detection instrument.



## **Truck-Mounted Cone Penetrometer Access Limits**

The SCAPS CPT support platform is a 20-ton Freightliner all-wheel-drive diesel powered truck. The dimensions of the truck require a minimum access width of 10 feet and a height clearance of 15 feet. Some sites, or certain areas of sites, might not be accessible to a vehicle the size of the SCAPS CPT truck. The access limits for the SCAPS CPT vehicle are similar to those for conventional drill rigs and heavy excavation equipment.

## **Cone Penetrometer Advancement Limits**

The CPT sensors and sampling tools may be difficult to advance in subsurface lithologies containing cemented sands and clays, buried debris, gravel units, cobbles, boulders, and shallow bedrock. As with all intrusive site characterization methods, it is extremely important that all underground utilities and structures be located using reliable geophysical equipment operated by trained professionals before undertaking activities at a site. Local utility companies should be contacted for the appropriate information and approval.

## **Response to Different Petroleum Hydrocarbons**

The relative response of the SCAPS LIF sensor depends on the specific analyte being measured. The instrument's sensitivity to different hydrocarbon compounds can vary by as much as two orders of magnitude. These variations in sensitivity are primarily a reflection of the variations in the PAH distribution of fossil fuel. Other contributing factors such as optical density, self absorption, and quenching are less important. As mentioned previously, the SCAPS LIF sensor responds only to PAHs that fluoresce when excited at 337 nm. This wavelength will excite aromatic compounds with three or more rings as well as some two-ring compounds. Aliphatic species, single-ring aromatics, and most two-ring PAHs do not contribute to the SCAPS LIF signal. The total observable fluorescence produced by any given petroleum hydrocarbon sample depends on the mole fraction of fluorescing PAHs along with the relative quantum efficiency of each of the fluorescing species. The fluorescence properties of a hydrocarbon mixture may also change after long-term exposure to and interaction with the environment. A contaminant that has been in the ground for any period of time will undergo changes in chemical composition due to weathering, biodegradation, and volatilization. In terms of degradation and transport, the lighter PAHs tend to volatilize and biodegrade first, leaving the heavier PAHs as time progresses. These are the PAHs that are preferentially excited by the 337-nm laser source used in the SCAPS LIF sensor.

## **Matrix Effects**

The *in situ* fluorescence response of the LIF sensor to hydrocarbon compounds is also sensitive to variations in the soil matrix. Matrix properties that affect LIF sensitivity include soil grain size, mineralogy, moisture content, and surface area. Each of these factors influences the relative amount of analyte that is adsorbed on or absorbed into the soil. Only the relative fraction of analyte that is optically accessible at the window of the probe can contribute to the fluorescence signal. Of the four influencing factors mentioned above, the dominant variable appears to be soil surface. LIF sensitivity to petroleum hydrocarbons on soil has been shown to be inversely proportional to the available surface area of the soil substrate. Sandy soils tend to have a much lower total available surface area than clay soils. A specific concentration of petroleum hydrocarbon compounds in sandy soils generally yields a correspondingly higher fluorescence response than an equivalent concentration in clay rich soils. In one study, soil samples were prepared as a series of sand/clay (illite) mixtures with progressively increasing clay content. The relative LIF response to DFM in each soil is essentially identical once the response curves

were normalized to the available surface area of each of the soils. The moisture content of the soil matrix is another influencing factor. The LIF sensitivity to petroleum hydrocarbons generally increases with greater soil moisture content, although in some natural soils the effect appears to be small. LIF response curves representing the results of fluorescence measurements on a soil with varying water content have also been generated. These results suggest that the response is fairly insensitive to changes in moisture content. In another study it was demonstrated that increasing the amount of water in a soil tends to narrow the sensitivity difference between sandy and clay soils. It is thought that water physically displaces the hydrocarbons from within the pore spaces of the matrix, effectively reducing the surface area available to contaminants. The effects of soil grain size has also been examined in laboratory studies. LIF sensitivity generally increases with increased grain size. The measured fluorescence was shown to be substantially greater in the coarser mesh sizes.

## **Spectral Interferences**

The SCAPS LIF sensor is sensitive to any material that fluoresces when excited with ultraviolet wavelengths of light. Although intended to specifically target petroleum hydrocarbons, the excitation energy produced by the LIF system's laser may cause other naturally occurring substances to fluoresce as well. At some investigation sites, it is possible that LIF sensors could respond to fluorescence originating from nonhydrocarbon sources. Many common fluorescent minerals can produce a measurable LIF signal. Other nonhydrocarbon fluorescent material introduced through human activity may be found in the subsurface environment. De-icing agents, antifreeze additives, and many detergent products are all known to fluoresce very strongly. The potential presence of fluorescence emission from nontarget (nonhydrocarbon) analytes within the soil matrix must be considered when assessing LIF field screening data. In some instances, the inability to discriminate between hydrocarbon fluorescence and nonhydrocarbon fluorescence can lead to false positives for the presence of hydrocarbons. Nonhydrocarbon fluorescence can mask the presence of hydrocarbon fluorescence, leading to reduced sensitivity or erroneous estimation of the relative amount of hydrocarbon present. In the worst case, spectral interference can lead to a false positive or false negative report of findings. Because the LIF sensor collects full spectral information, however, it is almost always possible to discriminate between hydrocarbon and non-hydrocarbon fluorescence by analyzing the spectral features associated with the data.

The SCAPS LIF sensor system uses a multichannel detection scheme to capture a complete fluorescence emission spectrum at each point along the push. An advantage of this approach is that spectral features are obtained that can be used to associate the signal with a specific petroleum class, mineral substance, or other material. The spectral patterns collected *in situ* provide the means to uniquely distinguish hydrocarbon fluorescence from potential interferences. The SCAPS LIF's ability to recognize nonhydrocarbon fluorescence has been tested in several laboratory experiments. In one study, the spectra of eight fluorescent minerals and five fluorescent chemicals were obtained with the LIF sensor. These spectra were compared with the LIF spectra obtained from multiple samples of jet fuel, gasoline, diesel fuel, and lube oil. In all cases, the hydrocarbon spectra could easily be recognized (by both computer algorithm and human analysts) as being different from the nonhydrocarbon spectra. The specific substances used in the experiment were chosen because they fluoresced in the same spectral region as the fuel products. Many other fluorescent chemicals and minerals fluoresce in a spectral region far removed from the hydrocarbon spectra. The materials used included calcium carbonate, resinous coal, Tide® surfactant, norbergite, aragonite, Prestone® antifreeze, fluorite, fossil algae, Simple Green® detergent, scapolite, turritella agate, and quinine sulfate.

In addition, the organic component of some soils contains humus. This naturally occurring residue of plant decay often contains some small amount of fluorescent PAHs. Laboratory tests have demonstrated that humics do not interfere with SCAPS LIF detection of hydrocarbon on soil. This is because humic fluorescence is minimal at concentrations found in even the most organic-rich soils.

### ***Technology Deployment and Costs***

The SCAPS CPT and LIF technology are designed to be operated by trained technicians from the AEC, U.S. Navy, and other licensees. It is not available for use by private citizens or corporations, but is available to state and federal agencies. The SCAPS truck is typically dispatched for three weeks to perform field screening and sensor validation at a site. Prior to the actual deployment of the system, the site is visited to determine location of obstructions such as buildings, cement platforms, fencelines, etc., as well as underground obstructions such as pipes and existing storage tanks. At this time, information on possible contaminants and prior efforts at characterization and/or remediation is also collected. Soil samples will be obtained for preparation of calibration samples.

The truck is typically deployed with a three-person crew and a geologist. Two people are needed to handle the push rods and operate the hydraulic press, and the third person operates the sensor, including measurements of the calibration and control standards, monitoring the actual real time push data, and measurement of the response from soil samples collected during the validation phase of the operation. Under typical conditions, up to 200 feet of pushes can be reasonably advanced in one day.

Following the site deployment, a field report is prepared for the site owner and applicable permitting or regulatory agencies that includes the raw data from the SCAPS pushes, the field borelogs, the analytical data, and a short summary describing the results of operations. This summary report is intended to be followed by a more thorough analysis, with in-depth discussion of site detection limits, the plume boundaries, and contaminant identification.

Cost estimates provided by the NCCOSC RDT&E Division indicate that the SCAPS CPT and LIF system can be deployed in two ways: as a turnkey operation or a more limited service.

For a turnkey operation, the daily cost is approximately \$4000.00 (assuming 200 feet per day), with an estimated per foot cost of \$20.00. The services include the CPT platform and LIF system; pre-deployment site survey; development of work plan, health and safety plan, and permit preparation; utility screening; field crew and supervising geologist; data analysis and review; and report preparation. On-site investigation-derived waste (IDW) handling is included, but does not include waste characterization or disposal. Additionally, the cost assumes local travel only (no per diem or distant travel costs), no mobilization/demobilization costs, no concrete coring, no permit fees, and gravity/surface grouting and restoration only.

The general SCAPS deployment with limited services costs approximately \$2500.00 per day (assuming 200 feet per day), with an estimated per foot cost of \$12.50. This option includes the CPT platform, the LIF system, and the field crew (crew chief, technician, and data analyst) and the supervising geologist. The customer would be responsible for utility locating; development of work plans and health and safety plans; all permitting; providing a site manager to identify push locations and site documentation; and drums for containment of IDW. The end product for this option would be the SCAPS LIF and geotechnical profiles for all pushes. Again, under normal conditions, 200 feet of pushes can be advanced daily. Concrete coring, grouting, permit fees, and distant travel costs or mobilization/demobilization costs are not included.

## Section 4

### Reference Laboratory Results and Evaluation

The purpose of this section is to address issues related to the reference laboratory used for these demonstrations. Section 4 is divided into four subsections. The first subsection provides details concerning the selection of ATI as the reference laboratory and the reference methods performed on the soil samples at ATI for the purpose of comparison with results from the LIF technology. The second subsection provides an assessment of data quality for the laboratory and gives a description of the quality control procedures for TRPH (total recoverable petroleum hydrocarbons by IR spectrophotometry) by EPA Method 418.1 and California DHS Method 8015-modified for TPH (total petroleum hydrocarbons by GC-FID). These methods will be referred to as TRPH and TPH throughout the remainder of this report. In the third subsection, the methods used to estimate accuracy, precision, and completeness are discussed and results provided. The final subsection provides a summary of the laboratory data quality evaluation and a brief discussion of how the laboratory results will be used for comparison with the results of the LIF technology.

#### ***Selection of Reference Laboratory and Methods***

To assess the performance of the LIF technology as a field screening tool for petroleum hydrocarbons in the subsurface, the data generated using the LIF technology was compared to data obtained using conventional sample collection and analytical methods. The analytical laboratory selected to provide reference analytical services, ATI, is certified in the state of California. The laboratory is located in San Diego, California.

ATI was selected because of its experience with QA procedures, analytical result reporting requirements, data quality parameters, and previous involvement with the SCAPS LIF program. ATI is not affiliated with NCCOSC RDT&E Division or any of the demonstration team members. ATI provided copies of the analytical results directly to SNL in order to maintain independence of the data. Copies of all QA and analytical procedures were provided to SNL for review prior to the demonstration and were included in the approved demonstration plan.

After discussion between representatives of State of California EPA, SNL, and the U.S. EPA, EPA Method 418.1 for TRPH and California DHS Method 8015-Modified for TPH were selected as the reference methods for the LIF technologies. The TRPH and TPH methods were chosen because of their widespread and generally accepted use in delineating the extent of petroleum hydrocarbon contamination. The TRPH and TPH methods are currently used as indicators of petroleum contamination in leaking underground and aboveground fuel tank investigations; as such they are the most comparable analytical methods corresponding to the objective of demonstrating rapid field screening using LIF.

EPA Method 418.1 for total recoverable petroleum hydrocarbons (TRPH) is used for the measurement of Freon-113-extractable petroleum hydrocarbons from surface and saline waters, soil, and industrial and domestic wastes. The sample is acidified to a low pH (<2) and serially extracted with Freon-113 in a separatory funnel. Interferences from polar animal oils and greases are removed with silica gel adsorbent. Infrared analysis of the extract is performed, and its absorption is directly compared to that measured on a standard mixture of hydrocarbons. This method is not recommended for more volatile hydrocarbons (C<sub>5</sub> to C<sub>7</sub>) due to loss of volatiles.

California Department of Health Services (DHS) Method 8015-modified for total petroleum hydrocarbons (TPH) is based on EPA SW-846 Method 8015 for determination of ketones, modified for determination of petroleum hydrocarbons in soil. It is used for the determination of gasoline and diesel in contaminated groundwater, sludges, and soil. After solvent extraction, a sample is injected into a gas chromatograph where compounds are separated. Compounds in the GC effluent are identified and quantified using a flame ionization detector. The chromatogram produced by this analysis covers the carbon range from C7 to C36 and can help to identify the product type using the n-alkane pattern distribution, pristane: phytane ratios, and the width of the unresolved complex mixture.

## ***Assessment of Laboratory Data Quality***

### **Audits**

As part of the cooperative agreement between the U.S. EPA and the State of California EPA Department of Toxic Substances Control, a representative of the California EPA audited the ATI laboratory in April 1995 and provided audit results to SNL. The audit found no irregularities and verified the procedures used to homogenize and analyze the discrete soil samples. SNL reviewed the ATI Quality Assurance Manual and all related procedures prior to the demonstrations (ATI, 1995).

### **Sample Holding Times**

The holding time specification for EPA Method 418.1 is 28 days from the sampling date. The holding time specification for California DHS Method 8015-modified is extraction within 14 days of sampling date. The required holding times per ATI SOP 105 from the date of sample receipt to the date of extraction and analysis were met for the samples from both sites. However, for the SNL samples, two samples (SNLDB11-5 and SNLDB11-10) were misplaced prior to homogenization and were left unrefrigerated in a sealed container for five days before being located. They were homogenized, extracted and analyzed per both methods within 14 days of the sampling date (CEIMIC, 1996). The results are shown in Table A-2. These samples had large concentrations (>10,000 mg/kg) of hydrocarbons that exceeded the LIF detection limit. For this verification study, the total concentration of the petroleum hydrocarbons in the sample was unimportant for the comparison; the fact that both samples showed contamination well above the LIF detection limit (qualifying the samples as “detect”) was important for the purpose of comparison to the LIF method. For this reason, they were not excluded from the data set.

### **Sample Preparation**

All soils were homogenized for five minutes prior to extraction and analysis per ATI SOP 421. Preparation of soils for TPH analysis was performed per ATI SOP 400 by diluting in methylene chloride. Preparation of soils for TRPH analysis was performed by extraction with Freon-113 for 45 minutes prior to analysis per ATI SOP 803.

### **Sample Analysis**

TRPH was determined by EPA Method 418.1 by calculating the linear regression of absorbance versus concentration. The concentration thus derived tells only the concentration of oils in the Freon-113 extract. This was then related back to the original sample. TPH was quantified by DHS Method 8015-modified by sample peak area using the mean response factor of the curve. The concentration was calculated using the response factor and the mean calibration factor obtained from prepared diesel fuel standards and adjusting for volume and dilution factors. FID was used for compound detection.

## Detection Limits

The ATI method detection limit for TRPH is 1.0 mg/kg for soil. The method detection limit for TPH is 5.0 mg/kg for soil.

## Quality Control Procedures

For TPH, quality control procedures included preparation of a calibration curve for instrument calibration using NIST-traceable standards. A reagent blank is extracted each time a batch of no more than 20 samples is extracted. An additional reagent blank is extracted for each batch of 20 samples in any given day. A blank spike is extracted with each batch of no more than 20 samples. Surrogates are run with each soil sample and quality control sample. Matrix spikes and matrix spike duplicates are also prepared and associated to no more than 20 samples of a similar matrix to check for precision and accuracy. Spiking is done directly into the sample prior to extraction. Spiking levels for fuel hydrocarbons are 100 mg/kg for soils.

For TRPH, a reagent blank, blank spike, matrix spike, and matrix spike duplicate were analyzed for each batch of 10 samples. Spiking level for petroleum hydrocarbons is 130 mg/kg for soils. A laboratory control sample was analyzed to verify the working curve, and a midrange check standard was run every tenth scan. The working calibration curve was prepared once per day.

Calibration standards were run at least every 10 samples to verify the calibration curve. In addition, a laboratory control sample (a midrange reference standard) was run at least once during each instrument run to verify the calibration curves. ATI did not provide written results of calibrations but reported verbally that all calibration and control standards were within acceptance limits or the procedures would have been repeated.

## Accuracy, Precision, and Completeness

This section discusses the accuracy, precision, and completeness of the reference method data. Tables 4-1 and 4-2 display the results of the quality control samples used to estimate accuracy and precision of the methods. The data from the reference laboratory was internally reviewed by ATI QC personnel before the data were delivered to SNL and NCCOSC RDT&E Division. SNL reviewed the raw data and quality control sample results and verified all calculations.

### *Accuracy*

Accuracy and matrix bias of the reference methods were assessed using laboratory spiked samples and, in the case of DHS Method 8015-modified, surrogate additions. Results of past PE audits of ATI were also reviewed to verify laboratory performance for accuracy and precision.

To estimate accuracy, the percent recovery is calculated using the following equation:

$$\% \text{ Recovery} = \frac{\text{Spiked sample result} - \text{Unspiked sample result}}{\text{Spike concentration}} \times 100\%$$

Diesel fuel standard was the spiking compound for the TPH method, and the surrogate is bis-2-ethylhexylphthalate. Surrogate recoveries were all well within laboratory acceptance limits (69-132% recovery). Blanks were prepared using sterilized silica sand as the "soil." The spiking compound for

TRPH was a prepared mixture of fuel hydrocarbons containing hexadecane, isooctane, and benzene. Blanks for both methods were prepared using sterilized silica sand as the “soil.”

The percent recoveries for the laboratory measurements of matrix spikes, blank spikes, and duplicate spikes for both methods are presented in Tables 4-1 and 4-2.

Cal EPA-DTSC also obtained splits of samples to independently verify ATI’s results at the State of California Hazardous Materials Laboratory. There was excellent agreement between both laboratories for TPH and TRPH.

**Table 4-1. Quality Control Results for TPH (total petroleum hydrocarbons by GC/FID, California DHS Method 8015-modified).**

QC Sample	ATI Acceptance Limits	Port Hueneme Demo Average Result	SNL Demo Average Result
Matrix Spike % Recovery	63-119% Recovery	88 (range 80-100)	100 (one sample)
MS Duplicate % Recovery	63-119% Recovery	86 (range 77-100)	110 (one sample)
MS Duplicate RPD	18%	3 (range 0-8)	4 (range 0-10)
Surrogate Spikes	69-132% Recovery	104 (range 97-126)	110 (range 100-126)
Blank Spike	61-125% Recovery	96 (range 90-100)	108 (range 100-110)
Reagent Blanks	<5.0 mg/kg	all < 5.0 mg/kg	all < 5.0 mg/kg

**Table 4-2. Quality Control Results for TRPH (petroleum hydrocarbons by IR spectrophotometry, EPA Method 418.1).**

QC Parameter	ATI Acceptance Limits	Port Hueneme Demo Average Result	SNL Demo Average Result
Matrix Spike % Recovery	74-126% Recovery	104 (range 79-118)	104 (range 98-106)
MS Duplicates RPD	20%	3 (range 0-20)	4 (range 0-13)
Blank Spike	88-118% Recovery	102 (range 90-118)	104 (range 100-110)
Reagent Blank	< 1.0 mg/kg	all < 1.0 mg/kg	all < 1.0 mg/kg

**Precision**

Precision of the reference method results can be estimated using the field duplicates by comparing the relative percent differences (RPD) for sample results and their respective field duplicates, or results of a laboratory spiked sample prepared and analyzed in duplicate, using the following equation:

$$RPD = \frac{|\text{Sample result} - \text{Duplicate result}|}{\text{Average result}} \times 100\%$$

Field duplicate samples were analyzed by both reference methods. After the soil samples were homogenized, nine of the samples from the Port Hueneme site and one of the samples (SNLDB11-40) from the SNL site were analyzed in duplicate (see Table A-1). This subset was selected randomly by the SNL verification entity in the field during the Port Hueneme demonstration, based on a visual assessment of the contamination of the sample; only the samples containing visually detectable hydrocarbon contamination were analyzed in duplicate. The sample for the SNL demonstration was selected after the demonstration based on inspection of the LIF results. The mean precision estimate (RPD) for the 10 total field duplicates was 10.7% for TPH and 16.5% for TRPH. Overall, this data shows good agreement between the samples and their respective field duplicates, indicating a high degree of precision by the reference laboratory.

The precision for the laboratory duplicates (Table 4-1, 4-2) was estimated by comparing the results of 14 pairs of matrix spike/matrix spike duplicates for TPH and 23 pairs of matrix spike/matrix spike duplicates for TRPH. Overall, these data show good agreement between the laboratory matrix spikes and their duplicates for both methods.

### ***Completeness***

Percent completeness is defined as follows for all measurements:

$$\%C = 100\% \times \left( \frac{V}{T} \right)$$

where

$V$  = number of sample measurements judged to be valid

$T$  = total number of discrete sample measurements

Results were obtained for all of the soil samples. A total of 130 analytical soil sample results plus nine field duplicate results using both TPH and TRPH methods were available from Port Hueneme. A total of 92 soil sample results for both TPH and TRPH plus one field duplicate sample result were available from the SNL Tank Farm demonstration data set. As mentioned earlier, two samples from SNL that were left unrefrigerated for 5 days at the laboratory were included in the data set because their suitability for comparison to the LIF measurements did not appear to be compromised. Based on these results, the completeness of the data set was 100 percent.

### ***Use of Qualified Data for Statistical Analysis***

As noted above, 100 percent of the reference laboratory results from Port Hueneme and SNL samples were reported and fell within laboratory acceptance limits. The data review indicated that all data were acceptable for meeting the demonstration objectives. The results of these analyses are presented in tabular form in Appendix A, Tables A-1 and A-2, and graphically in Section 6.

Although the two analytical methods are quite different, the TRPH and TPH measurements for both demonstrations were generally quite close, and using one or the other in determinations of agreement had little bearing on the results. Therefore, the laboratory measurements used for the comparisons required for this evaluation are based on the average result from these two analytical methods performed on a split sample at the laboratory.



## Section 5

### Demonstration Design and Description

#### ***Evaluation of SCAPS LIF Sensor Performance***

The performance of the SCAPS LIF sensor was evaluated to determine the percentage agreement between LIF "detect/nondetect" data and both TPH and TRPH results. Conventional sampling and analysis consisted of boring adjacent to the push holes with a hollow stem auger, collecting split spoon samples as close as possible to the push cavity, and analyzing the discrete samples at the reference laboratory. The data from the laboratory analysis of soil samples which showed TRPH or TPH contamination above the LIF detection limit were considered to show a "detect." Similarly, if *in situ* LIF readings registered above the LIF site detection limit, they would also indicate a "detect." The number of matches (detect/detect plus nondetect/nondetect) were tallied and reported as percentage agreement. The misses were indicated as LIF "false positives" or "false negatives." Because of natural interferences and fluorescent subsurface minerals, a greater number of false positives than false negatives was expected during the operation of the LIF technologies. Because the false positive data could be investigated with additional LIF spectral analysis, the primary goal was to keep the number of false negatives to no more than 5 percent.

Other sensor attributes evaluated included the ability to obtain near continuous measurements (at 0.2 foot intervals); the ability to provide detailed mapping of the distribution of subsurface petroleum contamination; the ability to provide a daily site detection limit in fluorescence and concentration based units; the ability to show good qualitative agreement with the pattern of contamination obtained from analytical measurements of semicontinuous soil samples; the ability to store and retrieve the entire fluorescence spectra for each push; the ability to use spectral data to distinguish hydrocarbon from nonhydrocarbon fluorophores; the ability to obtain sensor data in real time during each push; the ability to decide location of future pushes in real time; and the ability to detect the presence of hydrocarbons in the vadose zone, capillary fringe, and saturated zones. These sensor attributes were evaluated by observing them in the field during the demonstration.

Performance audits were conducted in the field to verify that the SCAPS LIF system was operated according to the procedures outlined in the demonstration plan.

#### ***Evaluation of SCAPS CPT Platform Performance***

The SCAPS CPT platform was evaluated by measuring or observing the following in the field: collection rate, maximum push depth, ability to achieve better depth measurement estimates than conventional drilling and sampling techniques, the ability to collect simultaneous geotechnical information to aid in interpreting contaminant distributions, and the amount of investigation-derived waste generated.

#### ***Description of Demonstration Sites***

Field demonstrations were conducted at two sites: (1) the Hydrocarbon National Test Site located at Naval Construction Battalion Center (NCBC) Port Hueneme, California, in May 1995, and (2) the Steam Plant Tank Farm at Sandia National Laboratories (SNL), Albuquerque, New Mexico, in November 1995.

## **Port Hueneme Site Description**

The NCBC Port Hueneme site encompasses approximately 4,000 acres on the Pacific coast in Ventura County, California. NCBC Port Hueneme is approximately 60 miles northwest of Los Angeles and is located immediately to the west and northwest of the City of Port Hueneme (Figure 5-1). NCBC Port Hueneme is an active naval facility where remedial investigation/feasibility studies (RI/FS) under the Navy's Installation Restoration Program (IRP) are currently in progress. The demonstration area is located at Site 22, the aboveground fuel farm. Site 22 is located in the southwestern portion of NCBC Port Hueneme, approximately 1,000 feet west of Hueneme Harbor and approximately 2,000 feet north of the Pacific Ocean.

## ***Port Hueneme Site History***

Site 22 includes five decommissioned aboveground fuel storage tanks numbered 5021, 5022, 5025, 5113, and 5114. The tanks are surrounded by a series of asphalt-paved earthen berms that restrict surface runoff and which were designed to contain the contents of each tank in the event of failure. Based on investigative findings during remedial investigation/feasibility studies activities, it appears that leakage has occurred from all five tanks or their associated piping.

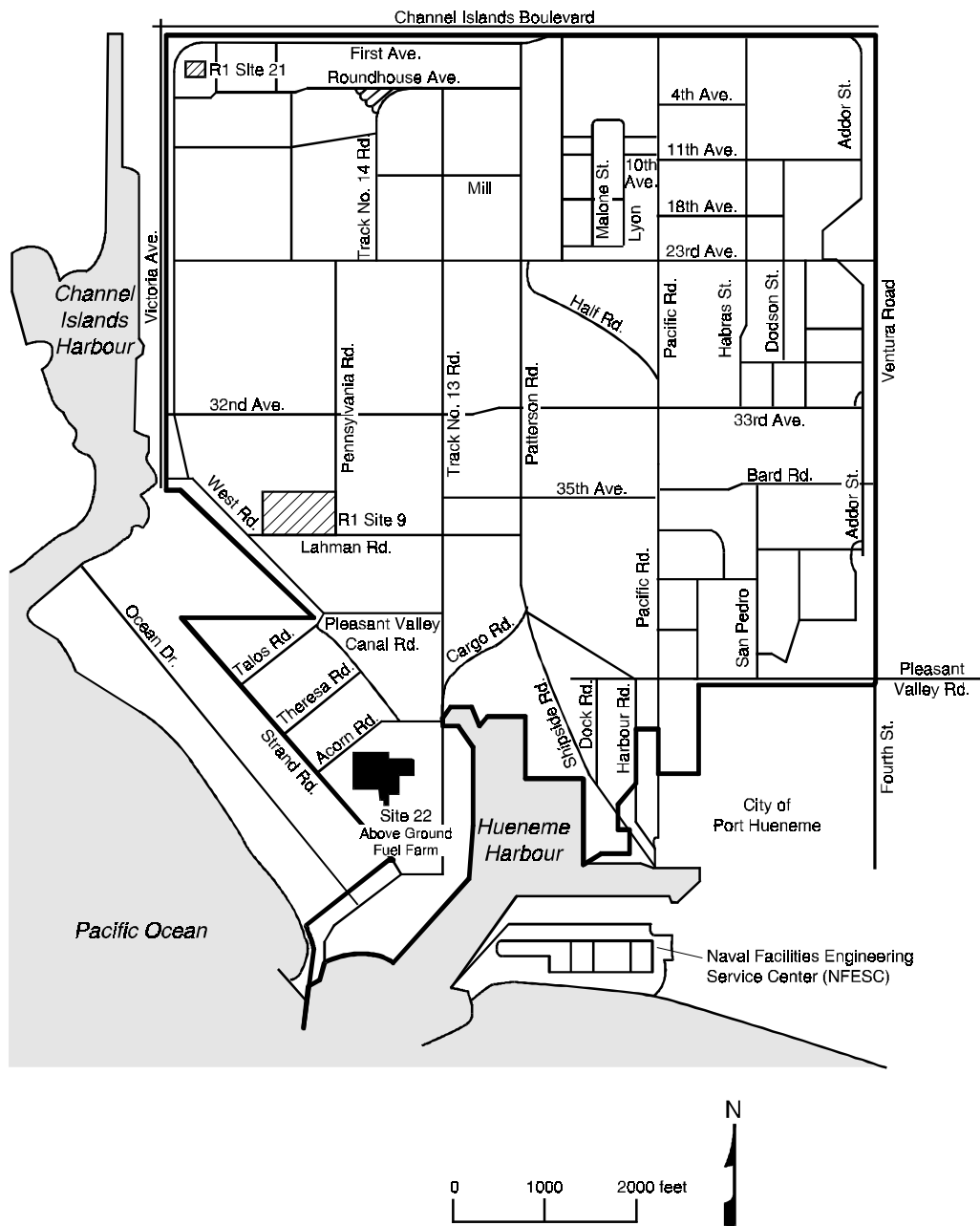
Based on the contaminant type and distribution in the vicinity of Tank 5114, this area was selected for the demonstration. Tank 5114, a 10,500-barrel capacity tank, was constructed in 1969 and used to store diesel fuel marine (DFM).

## ***Port Hueneme Site Geology and Hydrogeology***

The uppermost 1 to 2 feet of soil at Site 22 typically consist of orange-brown silty sand or silt. Below this interval is a layer consisting of predominantly medium-grained sand, tan in color, with some coarse and fine-grained sand. This sand layer is approximately 18 feet thick. Site 22 has been built up several feet higher than the surrounding region; the elevation of the ground inside the berms averages about 17 feet above mean sea level (msl). A dark gray silt layer is present below the sand layer corresponding approximately to 18.5 feet below ground surface (bgs). Recent measurements of groundwater elevations in monitoring wells at Site 22 indicate a groundwater flow direction to the south-southeast. Depth to groundwater is 11 to 13.5 feet bgs.

## ***Port Hueneme Site Contaminants and Distribution***

The soils and groundwater in the area around Tank No. 5114 have been contaminated by petroleum hydrocarbons. The full extent of the contamination has not been assessed; however, previous site investigations have indicated TPH levels exceeding 70,000 mg/kg to a depth of 20 feet bgs. Pre-demonstration sampling as part of this effort indicated TPH contamination at 24,000 mg/kg at a depth of 16 feet bgs. Laboratory analysis confirmed that DFM is present in the soil. Contaminants appear to have migrated vertically and reached their greatest concentration near the water table.



**Figure 5-1. Site vicinity map, Port Hueneme; NCBC Port Hueneme area is delineated by the dashed perimeter.**

### ***Predemonstration Sampling and Analysis***

A predemonstration sampling and analysis event was performed in accordance with the demonstration plan to evaluate the demonstration site and the standard analytical methods for verifying the LIF technologies. NCCOSC RDT&E Division conducted predemonstration sampling between April 4 and 12, 1995. Representatives of SNL and State of California EPA Department of Toxic Substances Control (Cal EPA-DTSC) were present during the predemonstration event. During the sampling activities, a number of individual SCAPS LIF pushes were advanced at the site. Following select pushes, a borehole was advanced adjacent to the penetrometer hole using a hollow stem auger with split spoon sampler, and discrete soil samples were collected. The soil samples were shipped to Analytical Technologies, Inc., (ATI) for confirmatory analyses. Representatives of Cal EPA-DTSC collected duplicates for analysis at the State of California Hazardous Materials Laboratory for verification of contaminants.

In addition to the soil samples submitted to ATI and the State of California Hazardous Materials Laboratory for chemical analysis, one to two soil samples per boring were submitted to the Law/Crandall geotechnical laboratory in San Diego, California. These samples were subjected to mechanical soil analysis for grain size estimation using ASTM Method 422 and for moisture and density analysis using ASTM Method 2937.

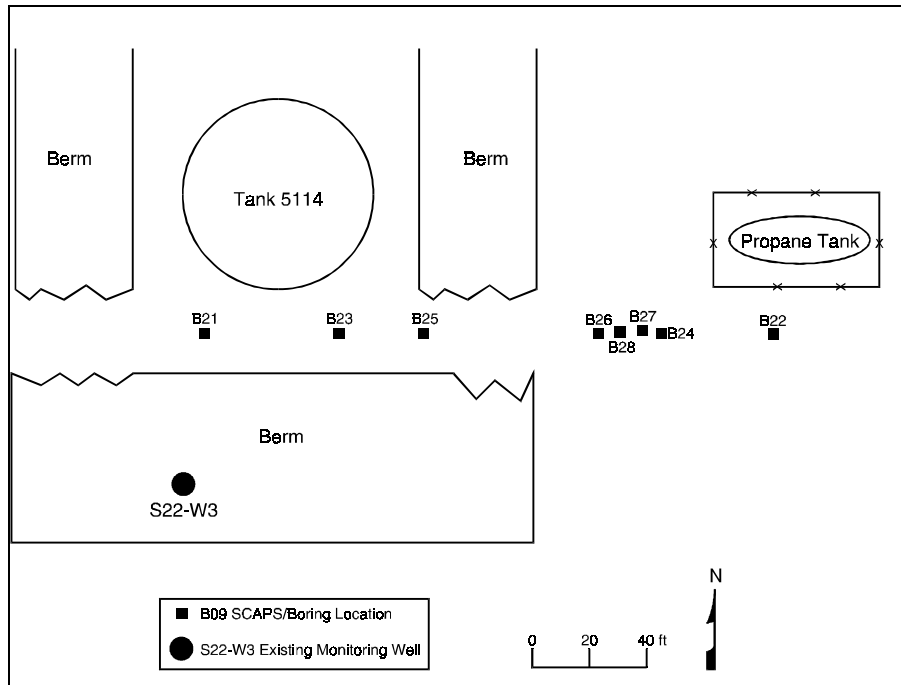
The results of the predemonstration sampling and analysis were used by the NCCOSC RDT&E Division to assess matrix effects or interferences, revise operating procedures where necessary, and finalize their performance claims. The developers and representatives of Cal EPA-DTSC, SNL, and U.S. EPA determined that the site and the contaminant type and distribution were acceptable for the purposes of this demonstration.

### ***Demonstration Sampling Operations, Port Hueneme***

The objective of the sampling design at Port Hueneme was to collect *in situ* LIF and conventional laboratory analytical data concurrently to demonstrate the LIF technology's capability to delineate the boundary (field screening) of a petroleum hydrocarbon plume. To accomplish this, a series of eight iterative pushes and comparison borings were advanced between Tank 5114 and the expected plume boundary. After each push, a boring was drilled adjacent to the push hole and sampled. The push and boring locations are depicted in Figure 5-2.

According to the demonstration plan, the SCAPS CPT platform alternatively pushed the SCAPS LIF probe and ROST LIF probe, producing a pair of pushes located approximately 8 inches apart, prior to the advancement of the comparison boring between the two push holes.

For the SCAPS LIF pushes, the SCAPS CPT platform was used to push the SCAPS LIF probe and acquire fluorescence data to a total depth of 16 to 20 feet bgs. Following the pair of pushes, the rig was moved completely away from the location and a hollow stem auger (HSA) drill rig was positioned with its stem center approximately 4 inches from the push hole. The HSA rig drilled a hole using an 8-in diameter hollow stem auger such that the internal diameter of the auger was parallel to, and approximately 2 inch offset from, the LIF probe cavity. Operating within this drilling geometry, the advancing auger flights destroyed the LIF probe's push hole while allowing for the collection of split spoon soil samples within approximately 3 inches (horizontally) of the push cavity. Soil samples were collected with a split spoon sampler lined with 6-inches long, 2.5-inches in diameter stainless steel tubes. The sampler was driven in advance of the lead auger using a 140-pound slide hammer falling over a 30-inch distance, in accordance with the ASTM 1586 Standard Penetration Test.



**Figure 5-2. Demonstration site and sampling locations, Port Hueneme.** B21-B28 are the locations of the HSA borings associated with the CPT pushes. For example, B21 is the boring associated with PHDP21, the initial SCAPS push.

Soil samples were collected from every 1 to 1.5 feet of boring starting at a depth of approximately 2 feet below ground surface. The sampler was overdrilled approximately 6 inches prior to retrieval to reduce the amount of slough soils typically in the bottom of the borehole. Only tubes containing sample soils that appeared relatively undisturbed were used.

The depth from which samples were collected was measured by lowering a weighted tape before and after sample retrieval. This permitted identification of the depth from which the samples were collected in the vadose zone to within approximately 3 inches. In the water saturated zone, however, sloughing and hydraulic soil movement (flowing or heaving sand conditions) were encountered which resulted in much greater uncertainty in identifying sample depth.

After each split spoon sampler was retrieved and the individual soil sample collection tubes were visually inspected, each soil sample was handled as follows:

- The soil sample tube was sealed with Teflon swatches and plastic end caps. The tube was labeled with the sample identification information.
- The end caps of the sealed, labeled soil sample tube were duct-taped in place, and placed into an insulated cooler with ice, recorded onto the chain-of-custody form, and held for shipment to ATI for analysis. The PRC sample custodian and SNL representative verified the accuracy and completeness of the soil sample chain-of-custody form and placed a custody seal on the cooler. Original field sheets and chain-of-custody forms accompanied all samples shipped to the reference laboratory.
- In addition to those soil samples submitted to ATI for chemical analysis, one to two soil samples per boring were submitted to Law/Crandall's geotechnical laboratory in San Diego, California. These

samples were subjected to mechanical soil analysis to determine grain size distribution using ASTM Method 422 and for moisture and density analysis using ASTM Method 2937. Those samples determined by grain size analysis to contain a substantial portion (>25 percent) of fine-grained material (defined as that passing through a #200 sieve) were subjected to hydrometer testing by ASTM Method 422. Although not part of the verification process, Law/Crandall Inc. performed the geotechnical laboratory analyses on selected soil samples to confirm the visual logging of the borings in the field.

- Rinsate samples of the split spoon sampler were collected to check for cross-contamination after decontamination of the sampler. The rinsate samples were submitted to ATI for analysis.

Ultimately, the data collected from the demonstration were used to compare *in situ* LIF results with conventional TPH and TRPH results.

### **Port Hueneme Sampling Locations**

The sampling locations were in a line running west to east located south of Tank 5114 (Figure 5-2). The first SCAPS LIF push was located in what was estimated to be an area within the plume and identified as PHDP21, at 6 feet east of the 0 foot location (Table 5-1). The first boring was advanced and sampled immediately after the probe was retrieved and the SCAPS CPT was moved away. A second push, designated as PHDP22, was then advanced in an area estimated to be outside of the plume boundary. The second boring was advanced and sampled immediately after the probe was retrieved and the SCAPS CPT was moved away. The strategy was to advance the first two pushes in locations that would bound the edge of the plume and then locate subsequent pushes, PHDP23-PHDP28, in an effort to close in on the horizontal extent of the plume. The distance between each successive push decreased until the edge of the subsurface hydrocarbon plume had been defined within 9 feet, for a total of 8 borings. The number of sampling locations was based on past use of the SCAPS LIF to define hydrocarbon plume boundaries at other sites and on demonstration budget constraints.

Each boring using the HSA and split spoon sampler was identified with a unique number assigned in the field. For example, PHDB21 identified the boring (B21) that was collocated with the initial SCAPS (PHDP21) push. Individual samples collected from each boring were sequentially numbered as they were logged; for example, PHDB21-5 identified the fifth soil sample collected from boring B21. Each sample was submitted for analysis accompanied by the chain-of-custody documentation.

Note that PHDP26A represents the second SCAPS push attempted at the location indicated in Figure 5-2. The first push was refused due to an impenetrable gravel/cobble layer within 6 feet of the surface. PHDP26A was offset 8" to the west of PHDP26 and was advanced without difficulty. PHDP27B was the third attempt to advance a SCAPS push at the location indicated in Figure 5-2. The third attempt was successful only after a pilot hole was advanced using an uninstrumented (dummy) probe. After removal of the dummy probe, the CPT and LIF probe was advanced through the pilot hole and LIF measurements were collected throughout the push.

**Table 5-1. Port Hueneme Boring and Push Summary Table.** The PHDP prefix denotes a SCAPS push at the Port Hueneme Demonstration. The PHDB prefix denotes the hollow stem auger boring.

Push or Boring Identification	Date	Comments
PHDP21 PHDB21	5-17-95	P21 located 6 feet east of zero point; B21 located 8 inches east of P21. Total of 15 samples collected; max depth 19 feet.
PHDP22 PHDB22	5-17-95	P22 located 200 feet 8 inches east of zero point; B22 located 4 inches west of P22. Total of 17 samples collected; max depth 19.5 feet.
PHDP23 PHDB23	5-18-95	P23 located 53 feet east of zero point; B23 located 4 inches east of P23. Total of 16 samples collected; max depth 19 feet.
PHDP24 PHDB24	5-18-95	P24 located 162 feet 8 inches east of zero point; B24 located 4 inches west of P24. Total of 21 samples collected; max depth 19.5 feet.
PHDP25 PHDB25	5-19-95	P25 located 81 feet east of zero point; B25 located 4 inches east of P25. Total of 16 samples collected; max depth 20 feet.
PHDP26A PHDB26	5-19-95	P26A located 141 feet 4 inches east of zero point; B26 located 4 inches east of P26. Total of 17 samples collected; max depth 20 feet.
PHDP27B PHDB27	5-22-95	P27B advanced through pilot hole of approximately 6 feet bgs. P27B located 157 feet east of zero point. B27 located 4 inches west of P27B. Note that pushes P27 and P27A were refused or excessively inclined in upper 5 feet due to gravel and cobble. Total of 19 samples collected; max depth 19.5 feet.
PHDP28 PHDB28	5-22-95	P28 advanced through 6-foot pilot hole 148 feet 8 inches east of zero point. B28 located 4 inches west of P28. Total of 17 samples collected; max depth 18.5 feet.

### SNL Tank Farm Site Description

The location for the second LIF demonstration was an active fuel tank farm for the Steam Plant at Sandia National Laboratories, Albuquerque, New Mexico (Figure 5-3). This site was selected because it represented a different climate, geology, and contaminant distribution than the Port Hueneme demonstration site. The Tank Farm site is an SNL Environmental Restoration Site that is currently being characterized and will begin a remediation feasibility investigation beginning in 1998. It is located in the southwest portion of Technical Area I on the northeast corner of the intersection of Hardin and Wyoming Boulevards (Figure 5-4). The 3-acre site is L-shaped and contains five tanks. The area west and north of Tank 5 was the area for this demonstration.

### Site History, SNL Tank Farm

The Steam Plant Tank Farm was constructed in the 1940s. All tanks contained #2 diesel fuel to be used as a backup supply system for the Steam Plant when the primary fuel supply (natural gas) was unavailable. The backup supply system has never been used and the fuel currently in the tanks is the original product delivered. One documented release of fuel occurred in June 1991, when the main valve of Tank 5 was left open and more than 5,000 gal of fuel was discharged into a holding tank at the Steam Plant (approximately one-half mile north of the tank farm). During transfer operations from the holding tank to another storage tank south of Hardin Boulevard, a leaking pipe was discovered. The pipe was then cut and capped, and the impacted soils in the area were scheduled for excavation. A few weeks later during excavation operations, it became evident that the fuel release was much greater than previously thought. Although the full horizontal and vertical extent of the plume was not determined, the 50 feet by 35 feet by 15 feet deep excavation pit was backfilled with the original fuel-contaminated soil. Recent site investigations using a Geoprobe® identified petroleum contamination down to at least 30 feet bgs in the area of the excavation.

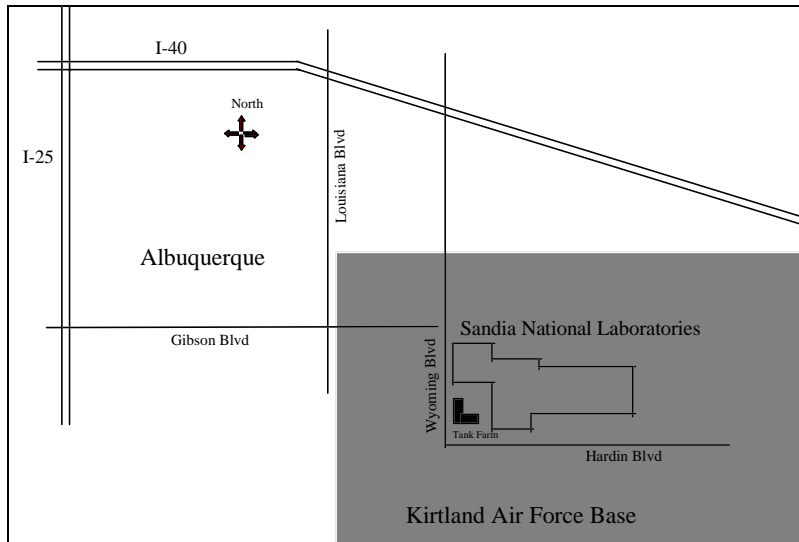


Figure 5-3. Site vicinity map, SNL Tank Farm.

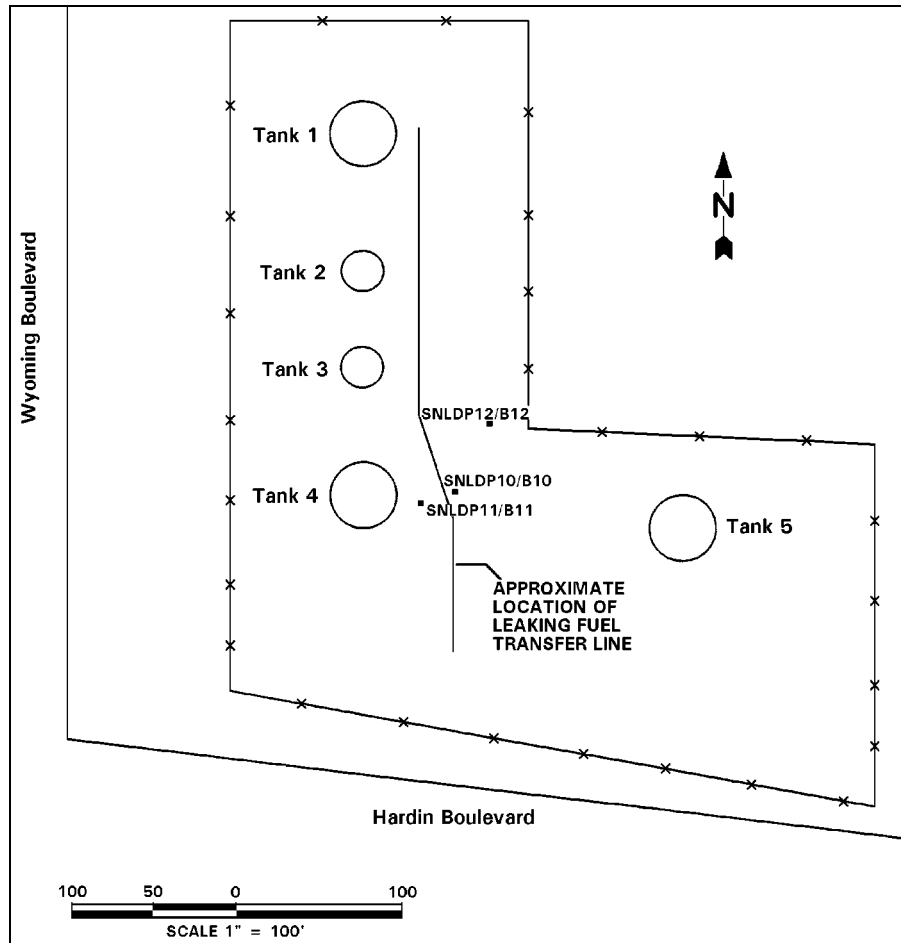


Figure 5-4. Demonstration site and sampling locations, SNL Tank Farm.



### ***SNL Tank Farm Site Geology/Hydrogeology***

SNL is located near the east-central ridge of the Albuquerque Basin. The basin is a rifted graben within the Rio Grande Rift that is bounded on the east and west by north-south trending faults. SNL lies on a partially dissected bajada formed by coalescing alluvial complexes. The deposits on the surface are composed of alluvial fan deposits shed from the eastern uplifts that interfinger with valley alluvium and consist of clayey to silty sands, with lesser amounts of silt, clay, and sand. Surficial deposits are underlain by a thick sequence (greater than 5,000 feet) of basin-fill deposits of interbedded gravels, sands, silts, and clays. Depth to groundwater is approximately 500 feet, with the potential for perched water at shallower depths. During the exploratory and informal predemonstration investigations, the SCAPS CPT consistently met with refusal near 52-57 feet, due to a consolidated gravel/caliche layer at this depth.

### ***SNL Tank Farm Site Contaminants and Distribution***

The SNL Geoprobe® investigations and the preliminary SCAPS investigations indicated diesel contamination greater than 1000 mg/kg in the vadose zone down to 56 feet. The area that was excavated down to approximately 15 feet and subsequently backfilled with the contaminated soil contains a somewhat homogenized mixture of diesel contaminated soil and uncontaminated soil. A high concentration of subsurface fluorescing minerals, most likely calcium carbonate, was identified prior to the demonstration. Calcium carbonate is present to some degree throughout the vadose zone in this area; it is more concentrated near the surface.

### ***SNL Tank Farm Predemonstration Sampling***

A formal predemonstration event was not conducted at the SNL Tank Farm site. The site was evaluated for its suitability as a demonstration site during a site exploratory tour by the NCCOSC RDT&E Division in August 1995. Two other arid locations were evaluated at this time and determined to be unsuitable for this demonstration. Immediately prior to the field demonstration in November, the NCCOSC RDT&E Division performed an informal sampling event to determine sampling locations for the demonstration. Earthen berms had been removed to allow access to contaminated areas. Following select pushes, stab samples (discrete soil samples collected using the cone penetrometer soil sampling apparatus) were collected and shipped to ATI for overnight confirmatory TPH and TRPH analysis. Laboratory analysis of the stab samples indicated TRPH of 3380 mg/kg and TPH of 3300 mg/kg (as diesel) at a depth of 25 feet. Nine SCAPS LIF pushes indicated fluorescence from the surface to 15 feet bgs, from 16 to 22 feet bgs, and from 39 to 56 feet bgs on several of the pushes. Carbonate was observed in all the discrete soil samples in varying concentrations by the professional geologist and confirmed by applying hydrochloric acid, causing release of carbon dioxide, to a few representative samples.

### ***Demonstration Sampling Operations, SNL Tank Farm***

The sampling operations at the SNL Tank Farm were similar to the operations at Port Hueneme Site 22, with the following changes.

Because the horizontal extent of the plume at Port Hueneme Site 22 had been delineated to within 9 feet with 8 pushes during the field demonstration, this capability of the SCAPS LIF technology was not the primary focus of the second demonstration. For the SNL Tank Farm demonstration, the developers and representatives of SNL and U.S. EPA determined that it would be preferable to collect more samples from areas expected to be contaminated to compare the LIF technology with the results from the reference laboratory analysis of discrete soil samples. The addendum to the demonstration plan reflected this change to the sampling strategy. For the demonstration, three SCAPS LIF pushes were advanced,

followed by three overborings. Based on the results of the informal predemonstration, the first push and boring were located in an area that had contamination throughout the push, the second push and boring were advanced in an area that had contamination from approximately the 40 to 50 feet depth, and the third push and boring were advanced in an area expected to be uncontaminated.

During the Port Hueneme demonstration, samples were collected throughout the contaminated and uncontaminated areas at intervals of every 1 to 1.5 feet. The experimental design called for several pushes to be located in clean areas in order to delineate the horizontal extent of the plume. This resulted in a large quantity of clean samples in the data set (114 nondetects of 130 total samples as determined by the reference laboratory). For the demonstration at the SNL Tank Farm, the experimental design was modified to focus discrete sampling in the impacted areas and limit the number of samples in areas expected to be unimpacted. This conserved resources and allowed for more comparisons of hydrocarbon-impacted samples (68 detects of 92 total samples as determined by the reference laboratory).

During drilling operations, discrete soil samples for reference laboratory analysis were collected using a California modified split-spoon sampler lined with 2.5-in diameter by 3-in stainless steel tubes. The smaller size of the sample tube was selected to allow for a greater number of discrete samples to be collected during a single 24-inch sample drive and would also permit finer scale resolution of the comparison of the LIF response to the reference laboratory analytical results. In addition, fewer samples were collected in the unimpacted boring. A total of 92 soil samples were collected during this demonstration, compared to 130 for the Port Hueneme demonstration.

All demonstration samples were collected and documented as previously described. Each SCAPS CPT push was identified with a unique number assigned in the field. For example, the tenth SCAPS LIF push was identified as SNLDP10 (SNL Demonstration, Push 10). Each boring was uniquely identified, such as SNLB10 for the boring (B) that was collocated with the initial SCAPS (SNLDP10) push. Individual samples collected from each boring were sequentially numbered as they were logged; for example, SNLDB10-5 identified the fifth soil sample collected from the tenth boring.

**Table 5-2. SNL Tank Farm Boring and Push Summary Table.** SNLDP represents the SCAPS push at the SNL Tank Farm Demonstration. SNLDB represents the hollow stem auger boring.

Push or Boring Identification	Date	Comments
SNLDP10 SNLDB10	11-6-95	P10 located 2 feet east of fuel transfer line. B10 located 4 in offset from P10. Total of 53 samples collected; max depth 56.25 feet.
SNLDP11 SNLDB11	11-7-95	P11 located 9 feet west of fuel transfer line. B11 located 4 inches offset from P11. Total of 28 samples collected; max depth 55.25 feet.
SNLDP12 SNLDB12	11-8-95	P12 located 50 feet north and east of P10. B12 located 4 inches offset from P12. Total of 20 samples collected; max depth 49.5 feet.

### ***Calibration Procedures, Quality Control Checks, and Corrective Action***

Calibration procedures, method-specific QC requirements, and corrective action associated with nonconformance QC for the LIF technology are described in the following paragraphs.

## **SCAPS LIF Initial Calibration Procedures**

Initial system setup requires calibration of a number of components in the SCAPS LIF system. A time-delay calibration was performed because the detector setup was gated for the duration of fluorescence emission return at the detector. An automated software procedure was run to determine the optimal time delay between laser firing and enabling the detector. A plot of intensity versus time delay was acquired and determined the optimal delay. The time delay varied solely as a function of the optical path length between the laser and the detector, which changed only with the length of fiber in the probe umbilical.

A wavelength calibration was also performed for the SCAPS LIF system to determine the parameters A0 and A1, which are the intercept and slope of the line converting detector pixel number into wavelength. A micrometer on the spectrograph was adjusted to center 500 nm on the center of the detector. The center 700 pixels of the 1024 in the detector were intensified; therefore, the starting pixel was set to 162, and the pixels-to-read parameter was set to 700. A mercury lamp was used to provide known wavelengths for calibration. A helium-neon (HeNe) laser was used to verify the calibration. This procedure was required after the spectrograph, the fiber input to the spectrograph, or the detector was changed. Recalibration was also required when the wavelength of the fluorescent standard was greater than 5 nm from the standard value.

Strain gauge calibration was performed in accordance with ASTM standard D3441. A load cell device and an automated software procedure was used to determine the scale and offset converting strain gauge output in millivolts to tons per square foot, for both the sleeve and cone tip strain gauges. This procedure was required each time a different probe assembly is used or when strain gauge zero checks (performed after each push) differ from zero by more than 1 ton per square foot (TSF) for the sleeve and 10 TSF for the cone tip.

The concentration calibration procedure was performed using a set of calibration standards (DFM-spiked site-specific soil samples) prepared by the serial addition method. The calibration standards were run in triplicate at the beginning of each day and again when equipment was changed. These samples were sequentially presented to the sapphire window for measurement. After measurement, the average and standard deviation was computed for each sample. If the standard deviation exceeded 20 percent for replicate analyses of any single sample, that sample was rerun. If deviation remained excessive, the system check standard was measured. If the check standard was out of compliance, system checkout and debugging was required. A calibration curve was generated by plotting the average of maximum fluorescence peak intensity versus the concentration of fuel product added to the calibration soil sample. A linear fit is performed yielding slope, intercept, and correlation coefficient,  $R^2$ . If the  $R^2$  did not exceed 0.90, the calibration curve was regenerated.

## **SCAPS LIF Continuing Calibration Procedures**

A fluorescent standard (10 mg/L quinine sulfate solution) was analyzed before and after each push. This measurement is a check of system performance and provides a means for normalizing measurements. If the fluorescent intensity changed by more than 20 percent of the initial value determined during pre-push calibration, system trouble shooting procedures were initiated.

## **Method Blanks**

A clean sand blank was measured pre- and post-push as part of the standard data collection procedure. If the clean sand blank LIF measurement varied beyond 50 percent of its pre-push calibration value, troubleshooting procedures were initiated.

## **Spike Samples**

Spiked samples were not used for monitoring the performance of the SCAPS LIF system. *In situ* measurement precludes the presentation of spiked samples to the LIF measurement system.

## **Instrument Check Standards**

A system check using a fluorescent standard (quinine sulfate, wavelength =  $458 \pm 2$  nm) was performed before and after SCAPS LIF data collection operations (concentration calibration and pushes). Both wavelength and intensity of the standard were monitored. If the wavelength differed by greater than 5 nm from the known value, a wavelength calibration was performed. If the intensity changed by more than 20 percent, system trouble shooting was required.

## **Performance Evaluation Materials**

Performance evaluation (PE) samples were not used for this demonstration. Because the LIF technologies are *in situ* measurement techniques, PE samples cannot be inserted into these dynamic measurement processes.

## **Duplicate Samples**

Due to the nature of the *in situ* measurement, duplicate samples cannot be measured by LIF. Soil heterogeneity and variation in contaminant distribution can be significant over short distances both horizontally and vertically. For purposes of this study, samples were taken from adjacent holes, drilled no more than six inches apart.

## **Equipment Rinsate Samples**

To assess whether cross contamination was being introduced during equipment decontamination, an equipment rinsate sample was collected daily. The source of the water for the equipment rinsate sample was the deionized water used for the final rinse step of the equipment decontamination process. Deionized water was poured over the sampler and into vials equipped with Teflon seals in a manner so that headspace was minimized. The equipment rinsate samples were sealed, labeled, and placed into an insulated cooler, logged on the chain-of-custody form, and submitted to ATI for analysis of TRPH and TPH using the reference analysis methods previously described.

## **Data Reporting, Reduction, and Verification Steps**

To maintain good data quality, specific procedures were followed by the developer and the SNL verification entity during data reduction and validation, and reporting. These procedures are detailed below.

## Data Reporting

The following data were reported to SNL:

1. Field data plots from all pushes, including SCAPS fluorescence intensity, cone pressure, sleeve friction, and soil classification, each with respect to depth. Also provided were the field plots of peak fluorescence wavelength versus depth, and all push data displaying the raw fluorescence spectrum collected during the pushes.
2. System check and calibration sample concentrations; tabulated raw system check and calibration sample fluorescence data; average system check intensity and system check ratio for each push; background, noise, and sensitivity calculated from calibration data.
3. Borehole logs indicating soil sample collection information, including sample numbers, depth of samples, location of water table, and other relevant information concerning the collection of the soil samples; chain-of-custody documentation associated with soil samples.
4. Laboratory results for TPH and TRPH measurements of soil samples, including the standard analytical results and quality control data.

## Data Reduction and Verification Steps for the SCAPS LIF Data

The LIF sensor records fluorescence intensity as a function of depth as the probe is pushed into the ground. In addition to this raw data, a system check standard was measured before and after each push, and a series of calibration samples were measured on a daily basis during the site operations. The raw data and daily calibration procedures were used to make decisions in the field. Following the conclusion of site operations, the raw fluorescence measurements were adjusted by a normalization factor, and the daily thresholds were averaged (after normalization) to provide site fluorescence and detection thresholds. This procedure is detailed below.

1. A site-average quinine sulfate value was calculated by averaging all the pre-push measurements of the quinine sulfate standard. For each push, and for the daily calibration measurement, a normalization factor  $QS$ , equal to the pre-push quinine sulfate measurement divided by the site average quinine sulfate value, was calculated. The LIF data from each push were normalized by dividing the fluorescence intensity by  $QS$ . The fluorescence intensity values for the calibration samples were also normalized by dividing by  $QS$ .
2. The fluorescence threshold and detection threshold values for each day were normalized by dividing them by  $QS$ , which is equivalent to regressing the normalized calibration data. The normalized threshold values were averaged to provide an overall site fluorescence threshold and detection threshold. These average threshold values were used to determine detects and nondetects for the verification phase of the demonstration.
3. To compare the *in situ* data with the soil sample analysis results, the normalized fluorescence intensity measurements taken at the depths from which the soil samples were gathered were tabulated. Because the sampling spacing for LIF data points is approximately 2.4 inches, the fluorescence data from all points corresponding to the 6-inch interval of soil sample from Port Hueneme were averaged to produce a single fluorescence intensity for a given sample. For the SNL demo, the sample interval was modified to 3 inches. Therefore, the fluorescence data from all points corresponding to the 3-inch interval of soil sample were averaged to produce a single fluorescence intensity for a given sample.
4. Fluorescence data were reduced to a detect or nondetect reading using the fluorescence threshold and associated detection limit as determined from the calibration samples. The average fluorescence reading corresponding to each soil sample was compared to the fluorescence threshold. Those

exceeding the threshold were recorded as detects; those falling below the threshold were recorded as nondetects.

5. Results from the reference laboratory were also reduced to a detect or nondetect reading. The laboratory result (TPH and TRPH) for each soil sample was compared to the site detection threshold. Those exceeding the threshold were recorded as detects; those falling below the threshold were recorded as nondetects.
6. Field notes and photographs were reviewed to verify that procedures outlined in the demonstration plan were followed.
7. On-site system audits for field operations and procedural quality assurance audits were conducted by SNL while the demonstration was being conducted. Audit results are reported in Section 6. Specifically, the SCAPS LIF system and operators were audited for compliance with the draft LIF method provided in Appendix C.

### ***Changes to the Demonstration Plan***

Because of the depth discrepancy between discrete samples collected using the hollow stem auger and the *in situ* LIF measurements that was noted after predemonstration sampling, the developers performed *ex situ* measurements of the discrete samples (called single-point tests or SPTs) after the demonstration. SPTs are measurements taken by placing a homogenized portion of a discrete sample (after laboratory analysis is complete) on the LIF probe window and recording the fluorescence intensity. This intensity can be compared to the reported laboratory result for the original sample and to the *in situ* fluorescence intensity. After the Port Hueneme demonstration, SPTs were performed by the NCCOSC RDT&E Division as an optional procedure to determine if there was a depth discrepancy between the LIF *in situ* readings and the discrete sample locations. Although SPTs were performed for both demonstrations, results of SPT measurements affected only the data evaluation for the Port Hueneme demonstration. Because the saturated zone was not encountered at the SNL Tank Farm, there was no depth discrepancy noted at this site. Results of SPTs for the Port Hueneme demonstration are reported in Section 6.

For both demonstrations, calibration standards were prepared using site-specific soil. The standards were measured daily at the start of operations. During the SNL Tank Farm demonstration it was determined that the soil collected at the surface for preparation of the standards was not representative of the nonimpacted soil at the site. The soil down to a depth of 10-15 feet had been excavated near the leaking fuel transfer line in order to repair the line, and then had been returned without remediation. In addition, the soil near the surface had a large concentration of calcium carbonate, which fluoresces quite strongly under UV light. It was determined that the calibration standards prepared prior to the demonstration were unusable. It was agreed by all parties that a revised set of calibration standards would be prepared using soil more representative of the subsurface environment. This soil was collected at a depth of 36 feet bgs using the split spoon sampler during advancement of boring SNLDB12, the nonimpacted location. New calibration standards were prepared after the demonstration at the NCCOSC RDT&E Division laboratory, and a new calibration curve was prepared. The revised calibration data were used to prepare the site fluorescence and contamination thresholds.

## Section 6

### Technology Results and Evaluation

The purpose of this section is to present and evaluate the SCAPS LIF results from the two demonstrations performed as part of this program. First, the developer claims are presented. Second, the accuracy, precision, and completeness of the SCAPS LIF data set are provided. Third, the SCAPS LIF results are compared to the laboratory results, and the performance of the technology is evaluated against the developer claims. Finally, a summary of the performance evaluation is given at the end of this section.

The *in situ* LIF results from both demonstrations are presented in Appendix B. The raw LIF data have been analyzed by SNL and presented in this section in a variety of formats to compare them with the reference laboratory results and to determine if the developer claims were met. The graphical depictions of the SCAPS LIF data were developed from the original data set.

#### ***Developer Claims Presented***

As stated in Section 5, the purpose of the demonstration was to generate appropriate field data to verify the performance of the technology as a field screening tool for identifying petroleum hydrocarbons in the subsurface. To accomplish this, two different sites were selected for demonstration locations: a shallow, coastal site and a deep, arid site. The LIF data were evaluated to determine the technology's performance relative to developer claims made in the demonstration plan. The LIF sensor data were compared to the data from laboratory soil analyses and the SCAPS CPT platform was compared to conventional sampling methods.

Specific claims for the SCAPS LIF sensor presented in the demonstration plan were:

1. Near continuous measurements generated by the sensor provide detailed mapping of the distribution of subsurface petroleum contamination. At standard push rates of 1 m/min, fluorescence data are typically collected at intervals of 0.2 feet.
2. The distribution of contamination provided by the LIF push data shows good qualitative agreement with the pattern of contamination derived from analytical measurements (EPA Method 418.1 and DHS Method 8015-Modified) of semicontinuous soil samples.
3. Calibration procedures have been developed to provide a site detection threshold based on a specified fuel product in a site specific soil matrix. This procedure is used to report the detection capability of the LIF sensor (specified in both fluorescence counts and in concentration units common to traditional analytical methods) on a daily basis. This procedure allows the detection capability of the LIF sensor to be specified in concentration units common to traditional analytical methods.
4. Direct comparisons of sensor data with samples collected using a split spoon sampler by overboring the push hole with a conventional auger, using the "detect/non-detect" criteria, show good agreement with conventional laboratory methods (EPA Method 418.1 and DHS Method 8015-Modified). Historically, agreement between the LIF sensor and the analytic soil measurements has exceeded 80 percent, and the "correlation" (percentage agreement with the reference lab results) for this demonstration will exceed 80 percent. False positives reported as a percentage of total analyses will be no more than 5 percent.

5. The SCAPS LIF sensor uses a detector system comprised of a spectrograph coupled to a linear photodiode array detector to collect the spectral signature of the induced fluorescence emission response. The entire fluorescence spectrum is collected and stored throughout the push.
6. Qualitative use of spectral data provides a means of distinguishing different classes of hydrocarbon products, and can also be used to minimize potential false positives from non-POL fluorophores. Different contaminants often have a different PAH distribution, resulting in a distinctive fluorescence spectrum for each class of contaminants. When dissimilar spectra are encountered during a site characterization, this can be indicative of more than one contaminant. Differences in spectral signatures can also be used to discriminate non-hydrocarbon fluorophores present in the soil.
7. Data from the LIF sensor are available in real time as the sensor is advanced into the ground. This allows real time decisions on how deep to sample the site.
8. The location of future pushes can also be decided in real time at the site using the information available from all previous pushes. This can greatly speed location of the edge of the contamination plume.
9. The LIF method can detect the presence of hydrocarbons in the bulk soil matrix throughout the vadose, capillary fringe and saturated zones.
10. Measurements can be made to depths up to 150 feet, when the LIF sensor is used in conjunction with an industry-standard 20 ton penetrometer push vehicle.
11. Geotechnical sensors (cone pressure, sleeve friction) are integrated with the LIF sensor to provide simultaneous continuous geotechnical and stratigraphic information to aide in interpreting contaminant distributions.
12. The *in situ* nature of the LIF sensor minimizes possibilities for contaminating or altering soil samples that are inherent with traditional collection, transport and analysis procedures.
13. The LIF sensor provides more accurate measurement of the depth of the contaminant, especially for sites where the contaminant is found in the saturated zone, because the LIF sensor does not suffer from the sampling difficulties encountered by other common methods such as soil boring/split spoon sampling. During typical operations, the uncertainty in depth with the SCAPS LIF sensor is approximately 3 inches.
14. The LIF sensor produces minimal IDW. A typical 20-foot push with the SCAPS LIF sensor produces approximately 10 gal of water IDW (used to clean the push rods). A typical 20-foot boring produces 55-75 gal of soil IDW as well as 20 gal of water used to clean the augers. Furthermore, the penetrometer rods are steam cleaned directly upon removal from the ground, reducing potential contamination hazards to site personnel.

These claims were evaluated individually and collectively throughout the demonstration and in post-demonstration data analysis. Results are summarized at the end of Section 6.

### **Technology Data Quality Assessment**

Data generated by the SCAPS LIF technology were compared to the data generated from analysis of soil samples using the two analytical methods. The quality of the reference laboratory data has been previously discussed, and all laboratory data were determined to be acceptable for comparison to the LIF technology data. The following LIF data quality indicators were closely examined to determine if the technology data were of sufficient quality to be compared to the reference laboratory data. The indicators evaluated for the SCAPS LIF technology were accuracy, and precision, and completeness.

#### **Accuracy**

Accuracy refers to the degree of agreement of a measurement to the true value. For an *in situ* field screening measurement technique such as LIF, determining the accuracy of the technique presents a



particular challenge. This is because it is not a simple matter to confidently assign a “true” value to a subsurface contaminant distribution. When compared to conventional laboratory-based measurements, the accuracy of the method is a function of both the sampling errors and errors associated with the measurement method.

Because there is no independent measure of the subsurface value of contaminant concentration, the accuracy of the *in situ* measurement was assessed by comparing it to results from conventional laboratory measurements. The percent agreement between TRPH (or TPH) and fluorescence data and percent false negatives was calculated using the equations that follow.

$$\% \text{ Agreement} = \frac{x_{..} + x_{++}}{x_T} \times 100\%$$

Where:

- $x_{..}$  = Number of samples where fluorescence is less than the detection threshold and the corresponding lab result is also less than the corresponding detection limit;
- $x_{++}$  = Number of samples where fluorescence is greater than the detection threshold and the corresponding lab result is also greater than the corresponding detection limit; and
- $x_T$  = Total number of samples collected for comparison.

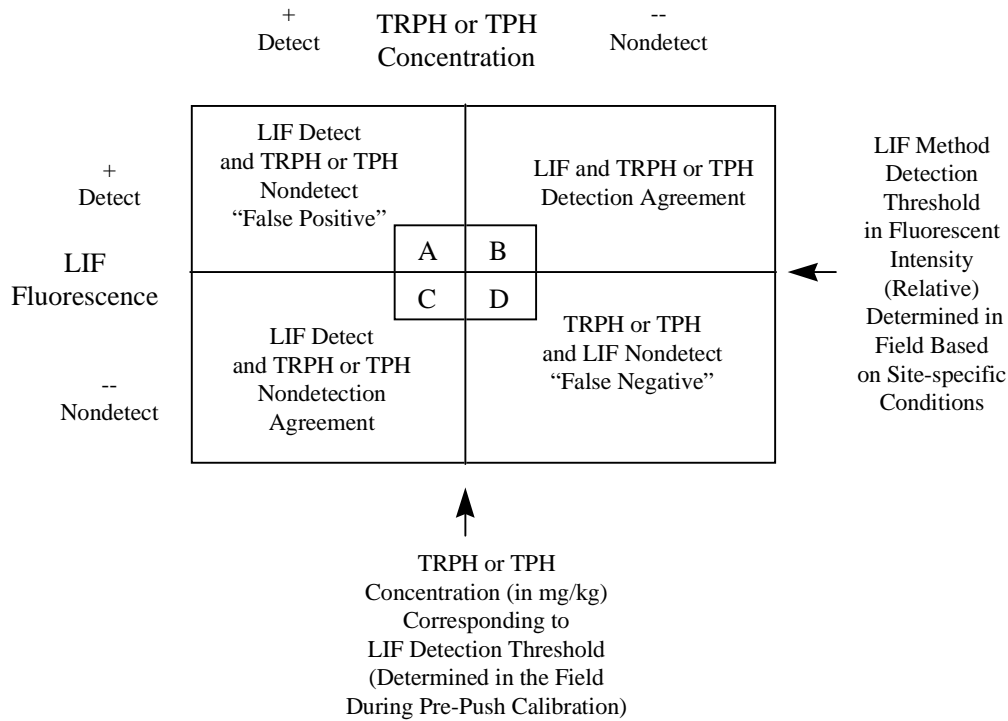
$$\% \text{ False Negatives} = \frac{x_{.+}}{x_T} \times 100\%$$

Where:

- $x_{.+}$  = Number of samples where fluorescence is less than the detection threshold and the corresponding lab result is greater than the corresponding detection limit.

The average of the SCAPS LIF measurements corresponding to a 6-inch interval (Port Hueneme) or a 3-inch interval (SNL Tank Farm) were compared to TRPH and TPH results for a discrete sample collected at the same depth. Possible results for each comparison are shown schematically in Figure 6-1.

Although results from two separate analytical methods were compared to the LIF data, the difference between the results in terms of detect/nondetect agreement was minimal, so an average result of the two methods was used for the graphical presentations in this section. Separate results for TRPH and TPH are included in Table 6-1. The average laboratory result from each homogenized soil sample was compared to the corresponding concentration detection threshold. If the laboratory result was above the concentration detection threshold and the average LIF data from the push at the corresponding depth exceeded the LIF fluorescence threshold, the result was a “detect/detect” (field B on Figure 6-1). If the average LIF data were below the threshold and the corresponding analytical data were above the corresponding detection threshold, the result was a “false negative” (field D). If the average LIF data were above the threshold and the laboratory results were below the corresponding concentration detection threshold, the result was a “false positive” (field A). If the average LIF data and laboratory results were below the threshold and corresponding detection limit, the result was “nondetect/nondetect” agreement (field C). This process was performed on each sample for both demonstrations. The results were used to determine the claims of 1) field screening capability, 2) at least 80 percent agreement, and 3) no more than 5 percent false negatives.



**Figure 6-1. Schematic of the four possible LIF and TRPH/TPH data categories.** This schematic indicates the four possible outcomes of the data comparison for each sample analyzed by the laboratory. The two lines crossing in the center indicate the LIF thresholds in fluorescent intensity and in concentration units. In order for either the laboratory or the LIF system to show a “detect,” the sample result had to be above the LIF threshold. Quadrant A indicates false positives (the SCAPS LIF had a “detect” but the laboratory did not), Quadrant D indicates false negatives (the SCAPS LIF had a “nondetect” and the laboratory had a “detect”), and Quadrants B and C indicate agreement between the SCAPS LIF data and the laboratory data.

**Table 6-1. Summary of comparison of results for Port Hueneme Demonstration.**

Category LIF/Lab	Compared to TRPH result	Compared to TPH result	Compared to TRPH/TPH mean
Nondetect/Nondetect Match	111	112	111
Detect/Detect Match	11	12	12
Nondetect/Detect Miss (“FN”)	5	4	5
Detect/Nondetect Miss (“FP”)	3	2	2
Total Samples	130	130	130
Percent ND/ND of Total	85.4%	86.1%	85.4%
Percent D/D of Total	8.5%	9.2%	9.2%
Percent Matches of Total	93.9%	95.3%	94.6%
Percent ND/D Misses (“FN”) of Total	3.8%	3.1%	3.8%
Percent D/ND Misses (“FP”) of Total	2.3%	1.5%	1.5%

## **Precision**

Precision refers to the reproducibility of measurements of the same characteristic, usually under a given set of conditions. Unfortunately, the conditions can vary in environmental data to an extent that leaves the term ambiguous. Differences from site to site, sample to sample within a site, and differences in results from repeated measurements from a single sample provide examples. Because the SCAPS LIF sensor's primary utility is for *in situ* sensing as the probe is pushed into the ground, it was not possible to obtain precision data for the sensor under conditions that exactly duplicated the manner in which *in situ* measurements are made in the subsurface.

During the Port Hueneme demonstration, an estimate of the instrumental precision was obtained by placing a standard cuvette containing a 10 ppm concentration of quinine sulfate dissolved in 0.1 N H<sub>2</sub>SO<sub>4</sub>) in front of the sapphire window and measuring the sample 20 times (20 laser shots for each analysis). This is the same as the system check procedure used before and after each push. Because the system check standard is in solution, it was considered to be homogenous. This procedure provided an estimate of the precision of the instrument. The standard deviation of the 20 measurements was less than 1 percent of the mean count.

## **Completeness**

Completeness refers to the amount of data collected from a measurement process compared to the amount that could be obtained under ideal conditions. For this demonstration, completeness refers to the proportion of valid, acceptable data generated using each method. It was anticipated that less than 100 percent completeness of both the LIF data and discrete sample analysis results would occur. For LIF data collection, a push that was refused due to contact with cobbles or other obstructions was disqualified. A substitute push was advanced in these cases, within 8 inches horizontally of the disqualified push. This occurred on pushes 26 and 27 at Port Hueneme. At this site, the refusals occurred near the surface, so the subsequent push allowed for LIF data to be collected near the same location. As long as the substitute push was located within 8 inches, the disqualified push was not counted against the completeness goal. Therefore, the completeness was 100 percent for Port Hueneme. At SNL, preliminary pushes had indicated an impenetrable gravel/caliche layer at approximately 50-58 feet bgs. While this was able to be penetrated by the HSA rig, the cone penetrometer was not advanced past this depth. The pushes were considered to be complete at the point of refusal. Therefore, the LIF data set was considered 100 percent complete for the SNL site.

Based on the evaluation of these data quality parameters, the SCAPS LIF data set was considered to be of sufficient quality to complete the verification process.

## ***Port Hueneme Site Data Presentation and Results***

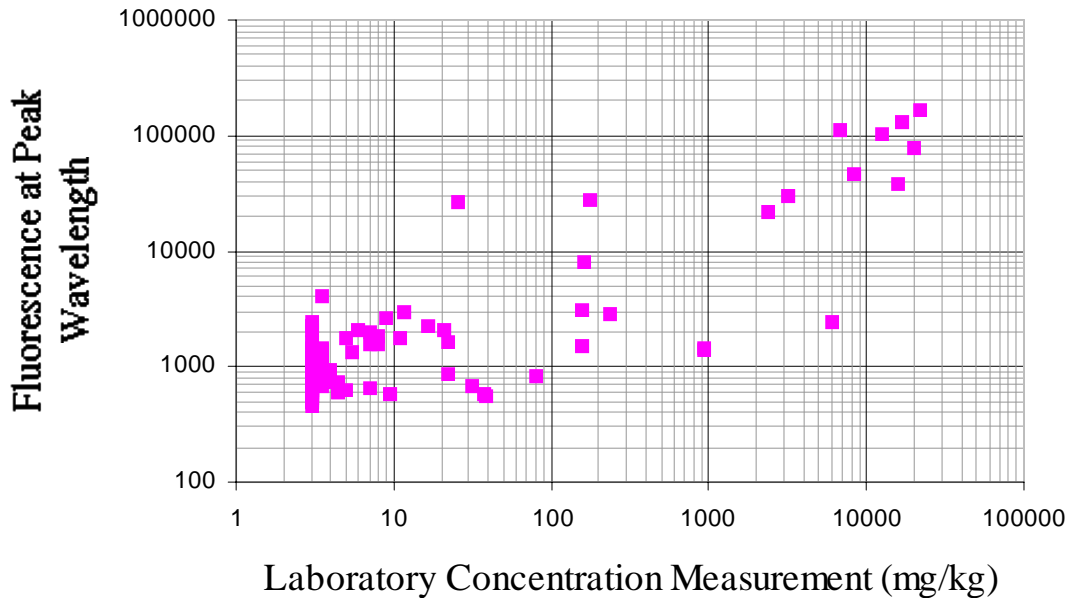
The data presented in this section are used to assess of the ability of the SCAPS LIF to provide field screening and mapping of subsurface contaminants in a shallow, coastal site with contamination in the vadose zone, capillary fringe, and saturated zone. The percentage agreement with the laboratory results of soil samples from the Port Hueneme demonstration site is reported in this section.

## Port Hueneme Detection Limit

As described in Section 5, the detection limit was determined on a daily basis in the field during the demonstration, and a composite site detection limit was used for determination of agreement. For the Port Hueneme site, the average detection thresholds were 3370 LIF counts (the daily threshold ranged from 2306 to 5433 counts) and 105 mg/kg (daily threshold ranged from 56.4 to 198.7 mg/kg) using DFM as the calibrant fuel. The reference method data were considered to show a detect when the value exceeded the Port Hueneme LIF site detection limit of 105 mg/kg. Because the soil samples were 6 inches long, the fluorescence for the 6-inch interval associated with each sample was averaged, and this average was compared to the detection limit. When the average *in situ* fluorescence result exceeded the average site detection threshold, this was designated a “detect.”

A chart showing possible "detect" versus "nondetect" results from comparing the LIF results to the laboratory data is shown in Figure 6-1. A corresponding plot of the data for the Port Hueneme demonstration is provided in Figure 6-2. A summary of results for the Port Hueneme demonstration are presented in Table 6-1.

## Results from the Port Hueneme Demonstration



**Figure 6-2. Plot of results of comparison of Port Hueneme LIF data with laboratory data.**

The average site thresholds described above are indicated by the heavy vertical and horizontal lines. The Port Hueneme site LIF detection threshold is 3370 counts. The concentration detection threshold is 105 mg/kg. The concentration measurements plotted are the average of TPH and TRPH results.

## **Downhole Results for Port Hueneme**

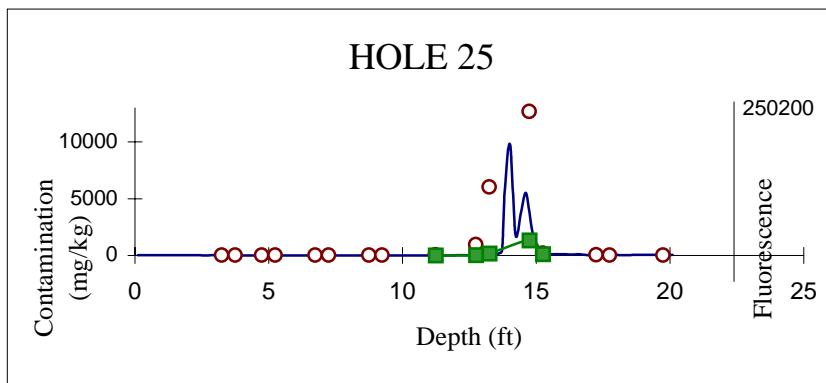
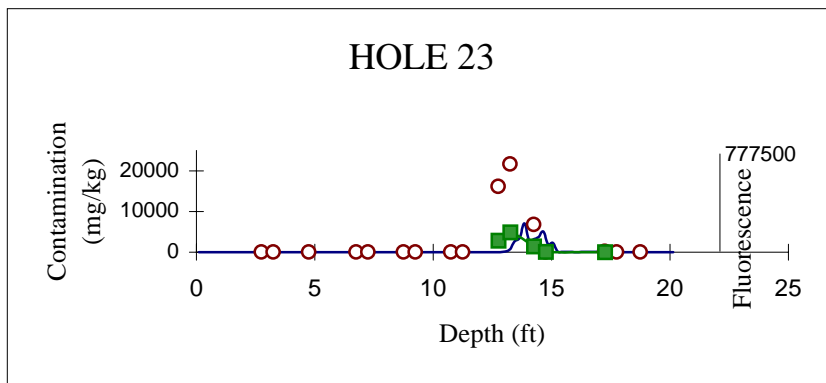
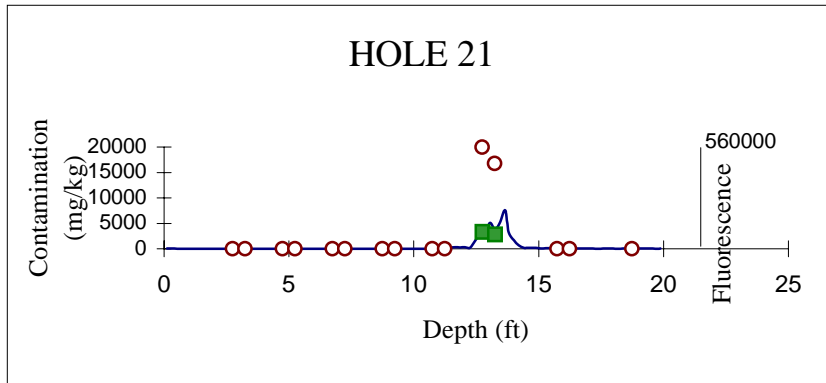
The LIF results obtained during five contaminated pushes at Port Hueneme have been plotted in Figure 6-3. These five plots indicate the pushes and associated borings along the transect near Tank 5114. The corresponding soil sample collection locations and results are also indicated. The square symbols indicate the locations and results of the single point tests. As discussed in Section 5, during the predemonstration event there was a depth discrepancy observed with the hollow stem auger and split spoon sampling operation, believed to be due to sloughing of sands in the saturated zone. This was also observed during the demonstration. The reference laboratory provided splits of the homogenized samples from the demonstration to the developer to perform single point tests (SPTs) at the developer's facility after the demonstration. The developer placed portions of the homogenates on the LIF probe window, and the fluorescent intensity was measured. SPT results were compared to the *in situ* measurements obtained during the demonstration.

On review of the SPT measurements and *in situ* measurements for both LIF technologies, SNL determined that on two holes, a slight offset was apparent that affected the results of the laboratory measurements that were compared to the data from both technologies. Field notes were reviewed to determine where sloughing of soils was most prominent. SNL determined that for holes 23 and 28, a depth adjustment of 4-6 inches for the laboratory samples collected in the saturated zone was appropriate. This adjustment supported (*i.e.*, improved) the percentage agreement results from both LIF technologies. All downhole results, including the adjusted data for holes 23 and 28, are presented in Figure 6-4.

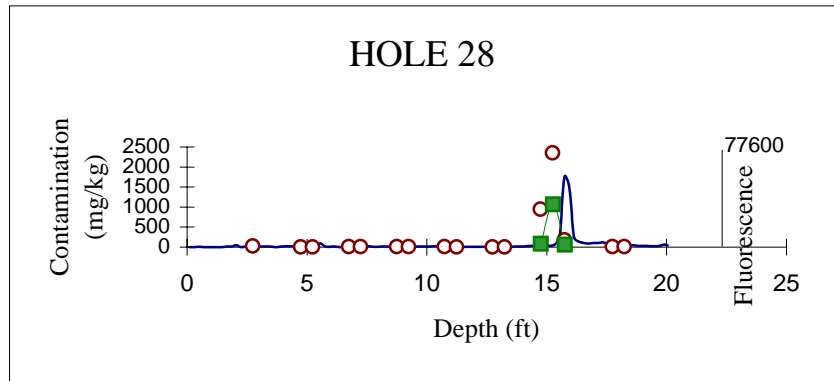
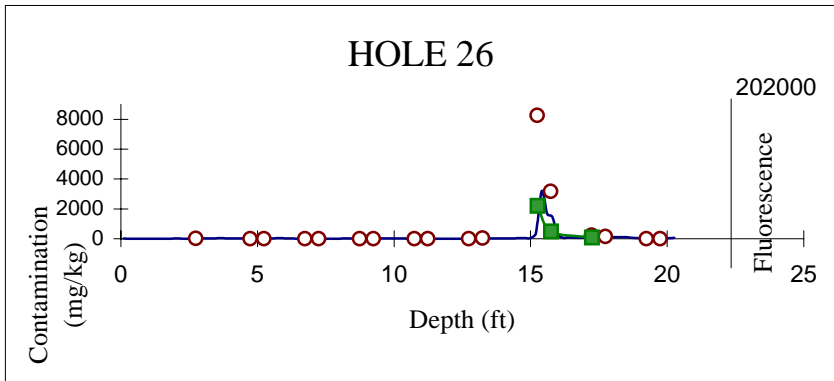
## **Port Hueneme Subsurface Contaminant Mapping**

The test areas at Port Hueneme and the transect along which LIF pushes and hollow stem auger borings were advanced to collect data for the performance evaluation are illustrated in Figure 6-5. Each symbol along a hole indicates where a soil sample was collected. The result of each data point was compared to the LIF measurement at the corresponding depth interval. The area of the plume was estimated based on the laboratory measurements. This figure illustrates several points:

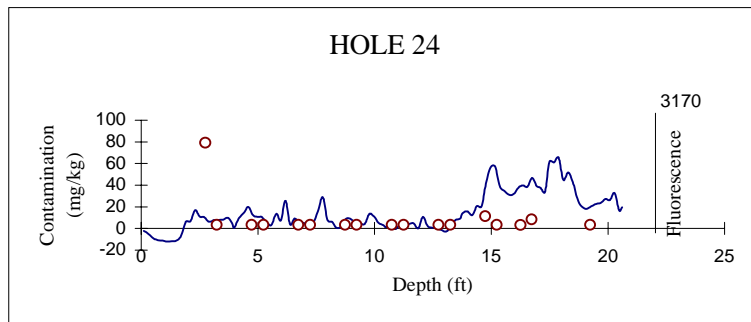
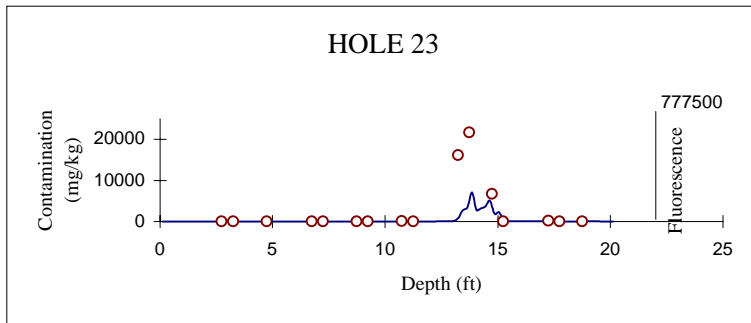
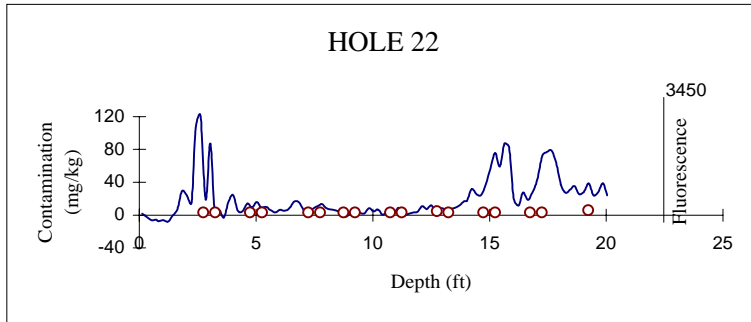
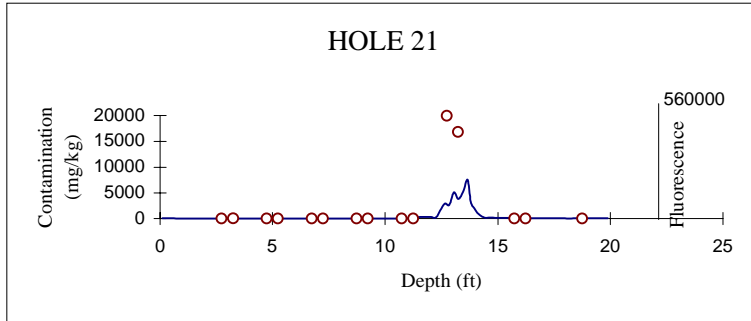
- the contaminant plume was narrow, and the false positives and false negatives, in general, were located at the plume boundaries,
- the LIF field screening technology was able to determine the horizontal extent of the plume within 9 feet, based on the results of 8 pushes, and
- soil samples were collected at 1-1.5 foot intervals and often missed the boundaries of the plume.



**Figure 6-3. Downhole results for Port Hueneme.** Results from the five drilling locations where single point tests were evaluated at NCCOSC RDT&E Division are illustrated above. The laboratory measurements are indicated by the circles, the single-point test measurements are indicated with the square symbols, and the LIF results are indicated by the continuous solid line. The horizontal axis is indexed by both concentration in mg/kg as measured by the average of the analytical methods and in counts measured by the SCAPS LIF technology. Note: It is inappropriate to compare the relative magnitudes of the laboratory concentration to the LIF peak as the LIF results are not linear at higher concentrations.

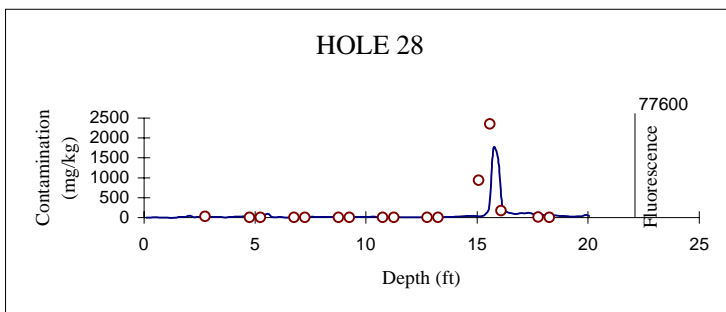
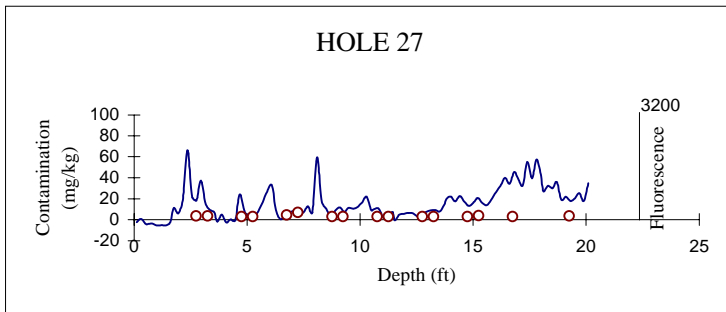
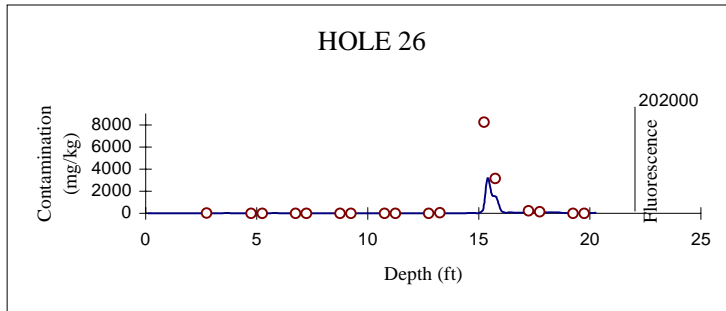
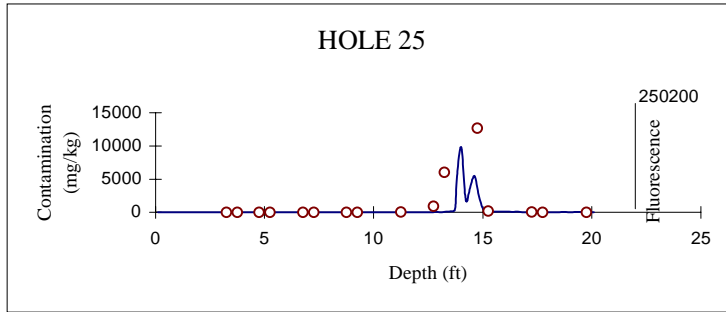


**Figure 6-3. Downhole results for Port Hueneme. (Continued)**

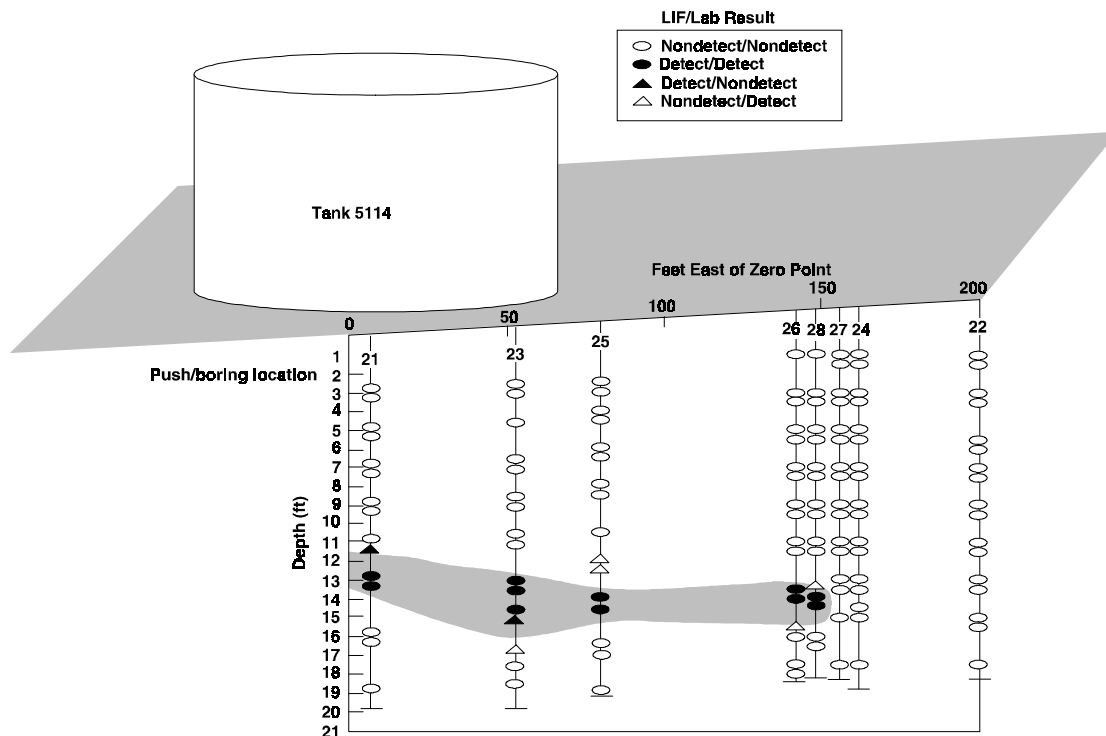


**Figure 6-4. Adjusted downhole results for Port Hueneme.** This figure provides a summary of all downhole results after adjustment for depth measurement inaccuracies due to sloughing that appears to have affected the measurements in the saturated zone at boring locations 23 and 28. Note that the vertical axes for the holes beyond the plume boundary, holes 22, 24, and 27, have a smaller scale than holes 21, 23, 25, 26, and 28, where contamination was detected.





**Figure 6-4. Adjusted downhole results for Port Hueneme. (Continued)**



**Figure 6-5. Cross-sectional map of transect near Tank 5114 at Port Hueneme.** A contour view of the results shown in Table 6-1, comparing the average ATI results to those of the SCAPS LIF system. The results are based on the adjusted downhole data shown in Figure 6-4.

### **SNL Tank Farm Site Data Presentation and Results**

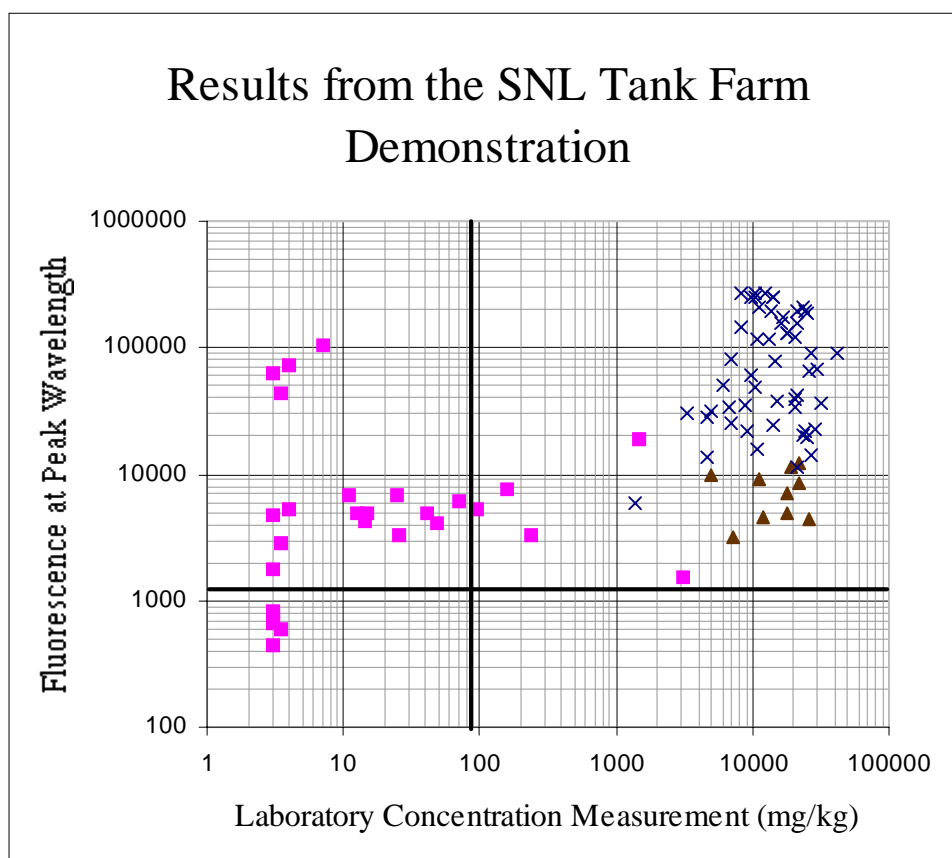
As described in the addendum to the demonstration plan, the purpose of the SNL Tank Farm demonstration was to demonstrate the capabilities of the LIF technology in an arid site with a deeper hydrocarbon plume. Again, the percentage agreement of the LIF technology data set with the laboratory analytical results of soil samples from the SNL Tank farm site provides the basis for evaluation.

### **SNL Tank Farm Detection Limit**

As described in Section 5, the detection limit was determined on a daily basis in the field during the demonstration, and a composite site detection limit was used for determination of agreement. For the SNL Tank Farm site, the detection limit determined in the field was 13317 LIF counts or 929 mg/kg DFM. During the demonstration, it was realized that the site-specific background soil to be used for preparation of calibration soils had been collected from the area that had been previously excavated. This soil had a high concentration of fluorescent minerals. A second set of calibration soils was collected at 36 feet bgs from boring 12 (the uncontaminated push/boring). This second set showed a more typical background fluorescent response (based on previous field deployments). It was agreed by SNL, Cal EPA-DTSC, and the developers that this soil would be used to prepare a second set of calibration standards after the demonstration. The site detection limit using this second set of calibration standards was 1094 counts or 89 mg/kg. During data analysis, when the average *in situ* fluorescence result exceeded the fluorescence threshold of 1094 counts, this was designated a detect. Because the soil samples were 3 inches long, the fluorescence responses for the 3-inch interval associated with each sample were averaged, and this average was compared to the detection limit. The TRPH and TPH

measurements were considered to show a detect when the value exceeded the SNL Tank Farm site detection limit of 89 mg/kg.

A chart showing possible "detect" versus "nondetect" results comparing the reference methods and the LIF fluorescence data is shown in Figure 6-1. A corresponding plot of the data for the SNL Tank Farm demonstration is provided in Figure 6-6. This plot provides an illustration of how well and where SCAPS LIF qualitative results (detect/nondetect) matched those of the laboratory methods. The figure indicates similar results to those of the Port Hueneme demonstration, in terms of match and miss percentages. The discrepancies are in regions that are impacted at levels close to the SCAPS LIF detection limit and in the areas where high carbonate fluorescence was observed. In the case of boring/push 10, the regions are separated from the plume because of the excavation, which redistributed hydrocarbon contamination near the surface. The actual percentage agreement is given in Table 6-2 (unadjusted results).



**Figure 6-6. Plot of results of comparison of SNL LIF data with laboratory data.** This scatter diagram illustrates the fluorescence counts and average laboratory measurements recorded for the SNL Tank Farm Demonstration. The different symbols represent different groupings of spectral shapes provided by the SCAPS LIF system in the field. "x" indicates samples with an obvious petroleum hydrocarbon spectral shape. "▲" indicates samples with spectra intermediate between the background spectral shape and the hydrocarbon spectral shape. The primary source of fluorescence in results, "■" was determined to be from carbonate materials occurring naturally in the soil at this site. For this reason, the matching percentages presented in Table 6-3 were computed as if all square symbols (17 false positives and 5 detect/detects) were nondetects for the LIF SCAPS technology. Table 6-2 shows that without this adjustment for carbonates, developer's claims were still met with 82 percent agreement and 18 percent detect/nondetect ("false positives").

**Table 6-2. Summary of comparison of unadjusted results for SNL Demonstration.** The results indicate that carbonates in the soil led to a large percentage (18%) of SCAPS LIF false positives but no false negatives.

Category LIF/Lab	Compared to TRPH result	Compared to TPH result	Compared to TRPH/TPH mean
Nondetect/Nondetect Match	7	7	7
Detect/Detect Match	68	68	68
Nondetect/Detect Miss ("FN")	0	0	0
Detect/Nondetect Miss ("FP")	17	17	17
Total Samples	92	92	92
Percent ND/ND of Total	8%	8%	8%
Percent D/D of Total	74%	74%	74%
Percent Matches of Total	82%	82%	82%
Percent ND/D Misses ("FN") of Total	0	0	0
Percent D/ND Misses ("FP") of Total	18%	18%	18%

**Table 6-3. Summary of comparison of adjusted results for the SNL Demonstration.** Several samples with high fluorescence were reclassified as nondetects based on their spectral shape and field observation of soil samples.

Category LIF/Lab	Compared to TRPH result	Compared to TPH result	Compared to TRPH/TPH mean
Nondetect/Nondetect Match	24	24	24
Detect/Detect Match	63	63	63
Nondetect/Detect Miss ("FN")	5	5	5
Detect/Nondetect Miss ("FP")	0	0	0
Total Samples	92	92	92
Percent ND/ND of Total	26.1%	26.1%	26.1%
Percent D/D of Total	68.5%	68.5%	68.5%
Percent Matches of Total	94.6%	94.6%	94.6%
Percent ND/D Misses ("FN") of Total	5.4%	5.4%	5.4%
Percent D/ND Misses ("FP") of Total	0	0	0

Unlike results established at the Port Hueneme site, detects in the Sandia Tank Farm demonstration could not be identified simply by comparing fluorescence counts to a threshold. Naturally occurring fluorescent minerals in the soil (*i.e.*, carbonates) caused a high level of nonhydrocarbon fluorescent detects and false positive results. Although carbonates occur naturally throughout the vadose zone in desert environments and were observed in soil samples at all depths, they were especially concentrated within 14 feet of the ground surface.

As a standard practice, in order to distinguish between hydrocarbon and nonhydrocarbon fluorescing materials, the SCAPS LIF operators evaluate the shape of the spectral signature from the fluorescent response and, if possible, examine discrete samples collected from the same location and depth. The discrete samples may be collected with the SCAPS stab sampler or, in the case of this demonstration, with the hollow stem auger and split spoon sampler. The carbonates can be distinguished from nonfluorescent soil by examining the soil sample (carbonate-based minerals appear as white crystalline material) and confirmed by pouring hydrochloric acid on the soil and observing release of a gas believed to be carbon dioxide.

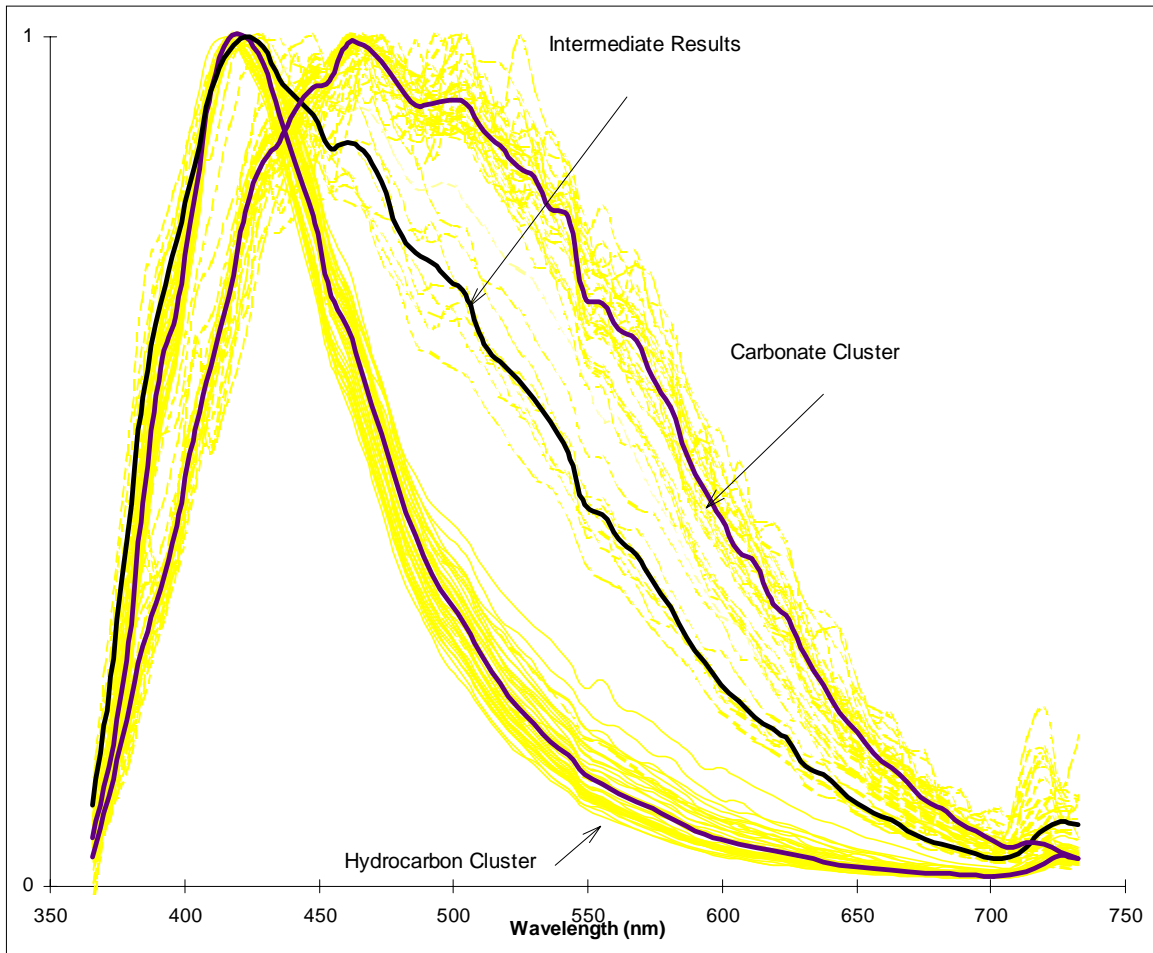
Typical spectral shapes for fluorescence responses (recorded at depths corresponding to the depths where discrete samples were collected) are depicted in Figure 6-7. Clearly there are at least two spectral groupings, one group peaking at 420 nm (typical for diesel) and one group peaking at 460-550 nm, and some spectra that appear to indicate intermediate results. The spectra have been normalized to give the same magnitude fluorescence at their peak wavelength so that differences in shape can be more easily identified. Further, statistical analysis indicated three fairly distinct groupings.

The SCAPS LIF operators, relying on the evaluation of spectral shapes and examination of the collocated soil samples, were able to reevaluate and reclassify areas of high fluorescent response. All percentages for agreement, false positives, and false negatives have been adjusted in Table 6-3 to reflect the additional information obtained from spectral interpretation. The SCAPS LIF is deployed with trained operators and geologists familiar with interpreting spectral information and identifying soil composition. In order to evaluate their procedures, the verification entity evaluated the spectral shapes independently to see if there was any difference in results. Using principal component analysis, and corroborated with field notes, SNL produced similar matching results.

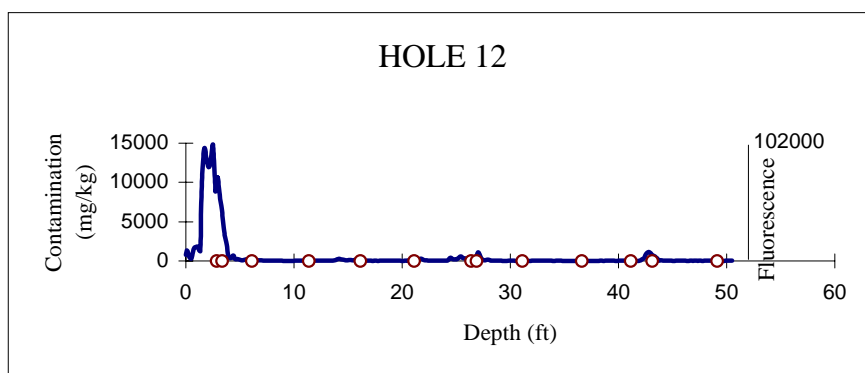
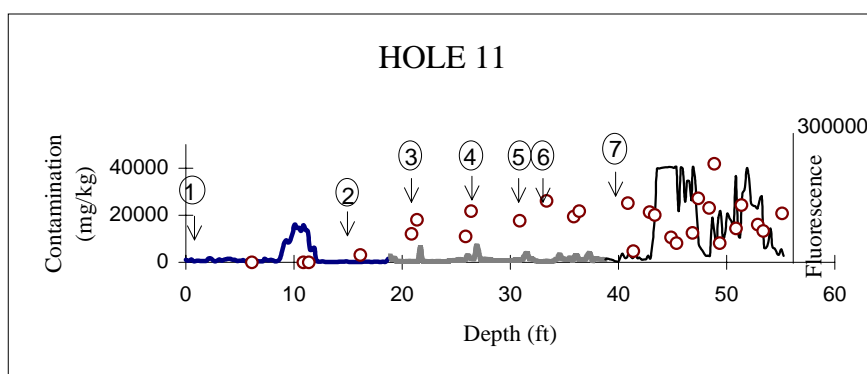
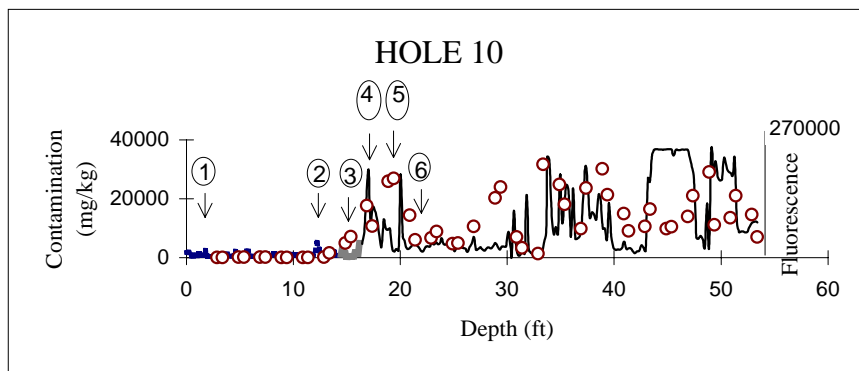
### **Downhole Results for SNL Tank Farm**

Figure 6-8 shows the downhole fluorescence measurements for pushes 10, 11, and 12 with different line patterns corresponding to the different spectral groupings and some of the relevant soil description comments from the field notes. The soil descriptions indicate that both the spectral group on the left in Figure 6-7 and the “intermediate results” group were contaminated with hydrocarbons. Both these groups fluoresce at a similar peak wavelength in the 420 nm range, as did the hydrocarbon-impacted areas in the Port Hueneme demonstration. This is a typical peak wavelength for polycyclic aromatic hydrocarbon spectra. Peak wavelength is monitored continuously in the standard operating procedure of the SCAPS LIF system and can also be used to suggest nonhydrocarbon fluorophores in the subsurface.

The area with the heavy solid lines indicate the areas where carbonate was identified in the field notes and evaluation of spectral shape indicated the high fluorescence was due to the subsurface minerals and not due to hydrocarbon impact, particularly in areas that had been excavated. These mineral fluorescence “detects” were reclassified as nondetects in the final evaluation of results by the developer. Because some of these carbonate-rich samples also had some hydrocarbon impact, the reclassified samples did not always match the laboratory results, resulting in a higher number of false negatives but no false positives in the final tally.



**Figure 6-7. Normalized spectra showing two distinct clusters.** The spectra plotted here are the normalized spectra obtained by the SCAPS LIF sensor at depths where soil samples were collected and analyzed by ATI. Most of the spectra appear to fall into one of two clusters, one peaking at 420 nm (hydrocarbons) and the other in the 460 to 550 nm range (background with carbonate fluorescence). The third intermediate group indicates there is hydrocarbon contamination and some influence from carbonate fluorescence. The heavy solid lines indicate the median values of the three groups.

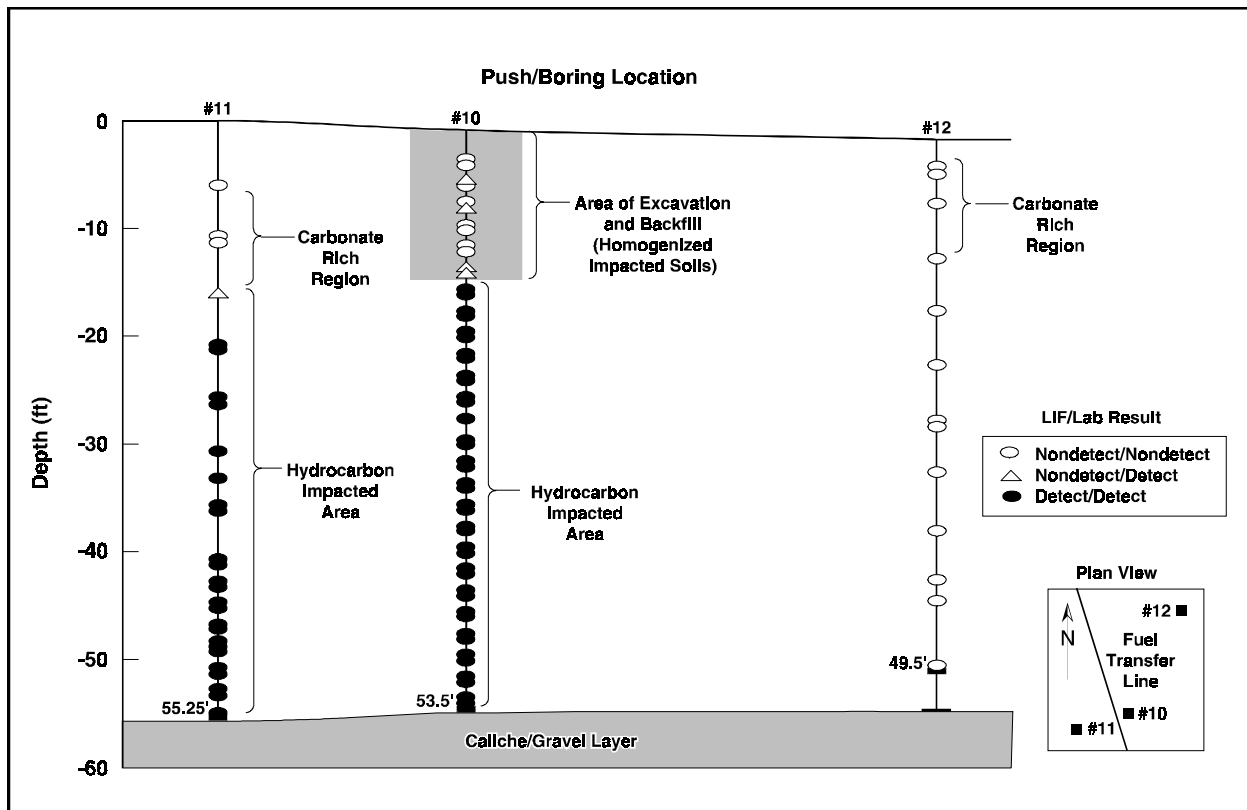


**Figure 6-8. Downhole results for SNL Tank Farm.** This figure illustrates the fluorescence readings, spectral type, laboratory measurements, and relevant field notes pertaining to examination of discrete soil samples. The different spectral classifications are indicated by the different line types in the fluorescence count plots. The heavy solid line is for the spectral group shown to the right in Figure 6-7. The dashed curves, shown in the middle regions of holes 10 and 11, indicate spectra intermediate between the two clusters in Figure 6-7. The thin solid curve at greatest depth in these two holes indicates fluorescence readings from the spectra in the left grouping of Figure 6-7. The arrows point to zones in holes 10 and 11 where hydrocarbons or carbonates were observed and noted in the field notes. No hydrocarbons were observed for hole 12. The circles indicate ATI analytical results. Field notes are indicated by numbers above the plots. The notes for samples from boring 10 are 1) carbonate rich, 2) slight hydrocarbon odor, 3) increasing odor, 4) strong odor, 5) hydrocarbon sheen, 6) decreasing hydrocarbon odor. Notes for samples retrieved from boring 11 are 1) carbonate rich, 2) faint hydrocarbon odor, 3) hydrocarbon odor, 4) hydrocarbon sheen, 5) sheen, 6) faint odor, 7) strong odor, hydrocarbon sheen.

## SNL Tank Farm Subsurface Contaminant Mapping

The test area at the SNL Tank Farm and the three collocated SCAPS LIF pushes and hollow stem auger borings are shown in Figure 6-9. Each symbol along a hole indicates where a soil sample was collected. The result of each sample was compared to the LIF measurement at the corresponding depth interval. The horizontal boundary of the plume cannot be estimated from the information obtained from the three pushes and borings; however, the areas of strong carbonate fluorescence and hydrocarbon contamination are evident based on the LIF and laboratory results. This figure shows several points:

- the contaminant plume was thick and migrated downward rather than laterally;
- the false negatives were confined to areas where the strong carbonate fluorescence signal masked the hydrocarbon fluorescence signal; and
- the point of refusal for the CPT pushes was the gravel/caliche layer at 50-57 feet bgs.



**Figure 6-9. Subsurface contaminant map for SNL Tank Farm.** Cross-section view of the results shown in Table 6-3, comparing the ATI results to those of the SCAPS LIF. The results are based on the adjusted downhole data shown in Figure 6-8.



## ***Geotechnical Data Assessment***

The SCAPS CPT provides CPT sleeve friction and tip resistance data as the probe is pushed into the ground at a rate of 1 m/min. The spatial resolution for geotechnical data is 1 sample/cm. The host computer stores sleeve friction, tip resistance, and soil characteristics as interpreted from the strain gauge data.

All discrete samples were visually logged and classified by the on-site geologist of the SCAPS CPT crew. Soil classifications were determined to be sand, silt and admixtures of both. In addition, 14 samples from five boreholes at Port Hueneme and seven samples from three boreholes at SNL Tank Farm were submitted to a geotechnical laboratory for grain size analysis to verify the field observations. The visual observations and the geotechnical laboratory grain size analysis were in general agreement and also agreed with the strain gauge data which provided soil classification information. Soil classification was determined from the tip pressure and sleeve friction data according to the procedure described in Robertson (1986).

Depth measurements were determined to be accurate by comparing the depth data recorded on the host computer to manual measurements made by the verification entity during rod additions for actual pushes in the field. Depths of sampling intervals for the HSA were measured in the field by lowering a weighted tape in the open borehole. Depth measurements were off by as much as 6 inches from sampling interval to sampling interval, especially in the saturated zone and capillary fringe.

## ***Overall Performance Evaluation***

In summary, the results of the demonstrations satisfy the requirements set forth in the demonstration plan and addendum for the SCAPS LIF system. The system located the plume accurately with higher matching percentage than the developer claimed. The false negative rate for the combined demonstrations was 4.9 percent, nearly identical to the five percent claimed by the developer. Disagreements with the laboratory results were primarily confined to regions where contaminant concentration levels were close to the detection threshold. A portion of these discrepancies could be partially the result of variability in laboratory results where random errors are estimated to be in the range of 10 to 15 percent.

As stated earlier, the performance of the SCAPS LIF was evaluated against the developer claims made in the demonstration plan. Evaluation of the developer claims for the LIF sensor is presented in Table 6-3, and evaluation of claims for the SCAPS CPT platform is presented in Tables 6-4 and 6-5.

## ***Cost Evaluation***

The SCAPS technology is designed to be operated by trained technicians from the AEC, U.S. Navy, or other licensees. It is not available for use by private citizens or corporations, but is available to state and federal agencies. The estimated cost of sampling using the SCAPS LIF system varies between \$12.00 and \$20.00 per foot depending upon whether the operators provide a turnkey operation or the customer provides field deployment assistance such as permitting, site management, and development of work and health and safety plans. Under normal conditions, 200 feet of pushes can be advanced per day. Concrete coring, grouting, permit fees, and distant travel costs or mobilization/demobilization costs vary with each deployment and thus are not included.

**Table 6-4. LIF sensor claims evaluation.**

LIF Sensor Claim	Result	Evaluation
Near continuous measurements provide detailed mapping of the distribution of subsurface contamination. Push rate 1 m/min, data collected at 0.2 foot intervals.	Push rate was 1m/min. Data were collected every 0.2 feet or less if cone slowed or stopped.	Met
Better than 80 percent agreement with conventional laboratory analysis of samples, with no more than 5 percent false negatives.	Average for both sites: 94 percent correct 1 percent false positives, 5 percent false negatives.	Met
Distribution of contamination shows good qualitative agreement with pattern of contamination derived from analytical measurements of semicontinuous soil samples.	Good agreement with pattern of contamination derived from results of semicontinuous soil samples.	Met
Site-specific and contaminant specific thresholds reported daily.	Thresholds were reported daily and used for determination of next push at Port Hueneme. Thresholds were averaged for site-specific thresholds for data verification.	Met
Entire fluorescence spectrum for each push is collected and stored.	All spectral data were stored and easily retrieved.	Met
Qualitative use of spectral data can be used to 1) distinguish different classes of hydrocarbon compounds and 2) minimize false positives from nonhydrocarbon fluorophores.	1) Only one class of hydrocarbon was available at each site; therefore, first claim not evaluated. 2) Spectral information was used to reclassify carbonate detects (false positives) to nondetects at SNL site.	1) Not evaluated 2) Met
Sensor data are available in real time as sensor is advanced into the ground.	Real time sensor data acquisition was observed during both demonstrations.	Met
Location of future pushes can be decided in real time.	Location of next push was determined in the field at the Port Hueneme site based on fluorescence results from the previous push.	Met
Can detect the presence of hydrocarbons in the vadose zone, capillary fringe, and saturated zones.	Hydrocarbons detected in the vadose zone at SNL; in saturated and capillary fringe zones at Port Hueneme.	Met

The main savings attributable to the SCAPS LIF system is that it can substantially reduce the number of wells drilled at a site. In a general site characterization effort, it can provide site characterization data in less time and far less expensively than conventional drilling and sampling. Investigation-derived wastes are minimal. Three times as much decontamination water per push was produced by the HSA, which required hazardous waste characterization prior to disposal. In addition, the SCAPS CPT does not generate soil cuttings.

Table 6-6 provides a comparison of deployment costs for the SCAPS LIF system and conventional drilling and sampling with a hollow stem auger drilling rig outfitted with a split spoon sampler, and off-site analysis for petroleum hydrocarbons.

**Table 6-5. SCAPS CPT claims evaluation.**

SCAPS System Claim	Result	Evaluation
Measurements can be made to 150 foot depths.	150 foot depth claim not evaluated at either site; max push depth was 57.6 feet at SNL. Review of previous deployments indicate maximum push of 101 feet at Guadalupe Oil Field. SCAPS CPT rods and fiberoptic umbilical allow a maximum push of 150 feet.	Not evaluated
More accurate depth measurements than HSA.	Depth uncertainty with HSA was observed to be 3-6 inches on comparison of <i>ex situ</i> and <i>in situ</i> LIF measurements. Depth uncertainty with SCAPS was measured to be less than 1 inch (Port Hueneme).	Met
Production of minimal Investigation-derived waste.	SCAPS system produced 8 gal/22 foot push. Decon water for HSA was 20 gal/22 foot borehole plus 12 gal/hole for decon of samplers (Port Hueneme).	Met
Integrated geotechnical sensors provide simultaneous geotechnical and stratigraphic information to aid in interpreting contaminant distributions.	Geotechnical and stratigraphic information was used to determine soil classification in real time. Strain gauge information was used at both sites to determine point of refusal of cone.	Met

**Table 6-6. Relative costs for the SCAPS LIF system.** Costs do not include per diem, permitting, interpretive report preparation, utility location, location surveying, or work plan preparation. These costs would be necessary in some circumstances but would be approximately the same for each.

SCAPS LIF <i>In Situ</i> Measurement		Conventional drilling with HSA, sampling with split spoon sampler, and off-site analysis	
10 pushes Depth of each push 30 feet Semi-continuous LIF samples plus geotechnical data	Cost	10 borings Depth of each boring 30 feet 60 soil samples 300 linear feet of borehole Analysis per DHS Method 8015	Cost
2 days field time @ 4000/day	8000	Drilling cost @ \$50/ft x 300 linear feet	15000
Sample semi-continuously at 1 sample/2 inches for LIF response, total of 1800 samples for 300 linear feet	Data included in above cost	Lab cost @ \$80/sample x 60 samples, TPH	4800
Sample continuously at 1 sample/cm for geotechnical data	Data included in above cost	Lab cost @ \$100/sample x 5 samples, geotechnical (grain size, moisture, density)	500
Cost of Drums for waste, 4 drums @ \$40/drum	160	Cost of Drums for waste, 28 drums @ \$40/drum	1120
Decon water characterization	1000	Decon water characterization	1000
No waste soil characterization	0	Waste soil characterization	3000
No waste soil produced	0	Waste soil disposal 20 drums x \$100/drum	2000
Decon water disposal 4 drums @ \$100/drum	400	Decon water disposal 8 drums x \$100/drum	800
4 man crew included	0	Geologist/Engineer 40 hrs x \$60/hr	2400
4 man crew included	0	Technician 40 hrs x \$40/hr	1600
TOTAL	9560	TOTAL	32,220
Per hole sample costs	\$956/hole	Per hole sample costs	\$3222/hole

## Section 7

### Applications Assessment

The SCAPS LIF technology is emerging as a supplement to and possible replacement for conventional drilling and sampling methods. As demonstrated, the SCAPS system and the LIF technology have advantages and limitations. These advantages and limitations are described in the following sections.

#### ***Advantages of the Technology***

##### **Real-Time Analysis**

Through the use of a cone penetrometer system, the SCAPS LIF provides real-time analysis of site conditions. This approach is faster than any competitive technology, and therefore quite useful for real-time decision making in the field. This is especially important in guiding soil sampling activities. For conventional field characterization, soil samples are collected using a standard drill rig and sent to a commercial laboratory for analysis. It can take weeks, and sometimes months, to get results. When the results are reviewed, a return trip to the field for further drilling and sampling may be indicated. Real-time sampling and data analysis often eliminates the expense and time delays of laboratory analysis and return trips to the field.

##### **Continuous LIF Data Output**

The SCAPS LIF has an advantage over conventional drilling and sampling methods in its ability to provide nearly continuous spatial data. It is common practice in environmental investigations to select a sampling interval (*e.g.*, 5 feet) to collect samples and ship to a laboratory for analysis. Characterization of the contaminant zone may be severely impaired when the data density is sparse as it commonly is with conventional drilling and sampling approaches due to budget constraints. Areas of contamination may go wholly unnoticed in extreme cases. The LIF system allows a continuous record of possible contaminant locations and a more complete delineation of the area of contamination. In addition, some drilling and sampling operations can be hindered by an inability to produce core samples, due to flowing sands or limited cohesiveness of the soils to be sampled, whereas the SCAPS LIF could potentially retrieve readings from these horizons.

##### **Continuous Lithological Logging**

The SCAPS system affords continuous logging of the subsurface lithology, with on-board sensors used in conjunction with the LIF sensor. This allows a user to target stratigraphy of interest, which may influence contaminant flow and transport or have potential interfering influences on the LIF readings. A conventional drilling and sampling program would require continuous core collection and a dedicated geologist to get the same level of detail. The geologist may be able to define finer scale attributes of the media, but only through a much more labor intensive effort. Compared to the conventional approach of sampling at regular intervals (*e.g.*, every 5 feet), the SCAPS CPT offers much greater resolution.

## **Cost Advantages**

When considered on a price per volume of characterization data, the SCAPS LIF provides a significant advantage over conventional drilling and sampling. Most importantly, the SCAPS provides nearly continuous data at a fraction of the cost of discrete sampling and analysis of the same area. The cost effectiveness of the SCAPS (without LIF) compared to conventional drilling and sampling techniques has been evaluated independently (LANL, 1991). They concluded that the SCAPS technology has a 30 to 50 percent cost savings for various scenarios analyzed. Cost information provided by the NCCOSC RDT&E Division indicates that per sample costs can differ by an order of magnitude.

## **Enhanced Operator Safety**

The SCAPS LIF system is safer than a conventional drilling and sampling program. There is little chance of contacting contaminated soils, because soil samples are only occasionally brought to the surface and the sensor is driven into the subsurface to take measurements. SCAPS workers are located in the SCAPS truck, and not in contact with the soil at the site. The cone penetrometer push rods are steam cleaned to minimize any residual contamination along the sidewalls of the device when retrieving the string. Grouting of the push hole can be done to minimize any potential cross-contamination of geologic units in the subsurface. With drilling and sampling methods, the soil cuttings are brought to the surface and potentially come in contact with workers and also must be disposed of as investigation-derived waste. The samples are handled by multiple individuals for packaging and transport, and for subsequent laboratory analysis, again providing an opportunity for exposure. Decontamination of the sampling and drilling equipment is most often done manually by drilling personnel rather than automated. The SCAPS system offers a clear advantage over conventional drilling and sampling in the area of health and safety of the crew.

## **Performance Advantages**

The SCAPS LIF technology works well in both the unsaturated and saturated zone. This may be important at sites with a relatively shallow water table or perched zone to delineate the continuity of the contamination across the interface.

The developer's performance claims were generally met in these demonstrations. Table 7-1 summarizes the performance statistics for the technology relative to the ability of the LIF to locate the presence of hydrocarbons. The developer claimed an overall detect/nondetect success rate of 80 percent. In other words, the laboratory and LIF data should be in agreement on detect or nondetect designations for the presence of hydrocarbons for 80 percent of the samples. The developer met this claim in all instances. The developer also claimed a false negative rate of no more than 5 percent. In other words, the developer expects that when the laboratory data indicate that hydrocarbons are present, but the LIF data signify a nondetect, the percentage of samples that fall into this category should be no more than 5 percent. In reality they met this claim with one exception, when the data were adjusted for carbonate influences at the SNL Tank Farm demonstration and the percent of false negatives was 5.4 percent. A probable reason for these false negative findings is that the appreciable carbonate fluorescence appears to mask the presence of hydrocarbons on spectral analysis. These statistics are quite positive given that the SCAPS LIF system is a field screening tool.

**Table 7-1. Performance statistics.**

Demonstration Site	Overall Detect & Nondetect Agreement Percentage Claim ( $\geq 80\%$ )	False Positive Percentage (implicit claim $< 20\%$ )	False Negative Percentage (claim $< 5\%$ )
Port Hueneme	94.6	1.5	3.8
SNL adjusted*	94.6	0	5.4
SNL nonadjusted	82.0	18.0	0

\* detects reclassified as nondetects due to carbonate fluorescence, as determined from spectral analysis

The SCAPS LIF system should meet the expectations of regulators or site owners interested in compliance with EPA sampling guidance (USEPA, 1989b). In designing sampling strategies the EPA has acknowledged the concepts of uncertainty and potential errors in analysis. They have incorporated these expectations in their guidance on allowable false positive and negative rates when comparing confirmatory sampling data to screening data. The EPA guidance on statistical sampling typically accepts a 5 to 10 percent false negative rate, which is within the range of the SCAPS LIF based on the results of these demonstrations. In addition, they allow a higher percentage of false positives, typically up to 20 percent. The SCAPS LIF system appears to be capable of meeting EPA's guidance of performance criteria for comparison of laboratory versus screening data.

### **Limitations of the Technology**

#### **Applicability**

The applicability of the SCAPS LIF system is limited to detection of petroleum products containing polycyclic aromatic hydrocarbons (*e.g.*, diesel fuel) that fluoresce when exposed to 337 nm wavelength UV light. The strongest response occurs if the compound contains three or more aromatic rings. Detection of other common contaminants such as light petroleum products (*e.g.*, BTEX), chlorinated hydrocarbons, and inorganics would require additional sensors. Therefore, the class of problems which this technology can detect is restricted, and mixtures of contaminants (*e.g.*, gasoline mixed with diesel fuel) may not be readily identified.

#### **Quantitation and Speciation**

The SCAPS LIF does not allow direct quantitation of particular constituents of the petroleum contaminants. The regulatory requirements for deciding cleanup requirements for RCRA or CERCLA sites are established on the basis of individual constituent concentrations (*e.g.*, naphthalene concentrations) through comparisons with background, or established through the use of risk assessment techniques.

The LIF system is has been calibrated to TPH, which is appropriate for underground storage tank regulatory cutoff criteria, but may not be appropriate for RCRA or CERCLA investigations as a screening measure. Again, the RCRA and CERCLA requirements are formulated around contaminant-specific concentration thresholds, and not aggregate measures of a total class of products, such as TPH. TPH is affected by many things and is not readily correlated to individual constituents. Also, the LIF system is calibrated to TPH for the purpose of defining detects versus nondetects of petroleum hydrocarbons (with a cutoff threshold) and not intended to provide relative concentration measurements of TPH. For underground fuel tank applications, typically an action level of 100 ppm TPH is used for delineation of areas of potential concern. The LIF detection limits determined using the developer's calibration procedure for detect/nondetect site evaluations are often higher than 100 ppm TPH and may result in an area of concern not being defined to a regulator's satisfaction.

On the other hand, an analysis of the data from the first demonstration at Port Hueneme showed that a certain amount of conservatism was built into the procedure for establishing detection thresholds. The data from Port Hueneme would have essentially the same detect/nondetect statistics if the cutoff were 40 mg/kg or greater, 2 to 3 times less than the detection limit of 105 mg/kg. A relaxation of the error allowance in the calibration procedure would likely allow a 100 mg/kg or lower detection threshold to be achieved in most circumstances. Additional testing would be required to adequately test this hypothesis.

### **Push Limitations**

A cone penetrometer system is limited in its ability to hydraulically push through certain stratigraphies (*e.g.*, boulders, cobbles, caliche). The maximum depth is governed by site-specific stratigraphy and the method is limited to sites where the cone penetrometer can be pushed to the depth of concern through primarily unconsolidated sedimentary deposits or formations. This can limit the applicability of the SCAPS LIF deployment to sites which have less severe geotechnical characteristics. It should also be noted that the sensor location for the LIF is some distance above the cone tip (*i.e.*, 60 cm), and when refusal occurs due to a stratigraphy change the sensor does not actually get to that depth horizon. This can be problematic if the stratigraphic layer is also an impedance to flow and transport of the contaminants, thereby offering an opportunity for the contaminant to become concentrated at the interface boundary. In this case the LIF sensor would not be able to address the issue unless the constituent concentrations were elevated 60 cm above the interface or refusal depth.

### **Interferences**

The LIF system is subject to interferences which can make data reduction complicated, and limit the real-time nature of data analysis and decision making. Moisture in the soil and fluorescing compounds or minerals (*e.g.*, carbonates) are examples of naturally occurring constituents which affect the LIF readings and influence performance statistics.

### **Conclusions**

The SCAPS LIF system is an emerging technology worthy of pursuit in site investigations where polycyclic aromatic hydrocarbons (*e.g.*, petroleum, oils, and lubricants) are suspected. The technology offers a number of advantages over conventional drilling and sampling technologies for the purpose of screening a site for the nature and extent of contamination. It does not entirely take the place of a conventional sampling program, but adds significant benefits in terms of resolution of the nature and extent of contamination. This information, when used properly, could provide a more complete picture of the contamination, and also could be used to predict future sampling locations. As noted above, there are some disadvantages of which a prospective user should be aware when designing an environmental investigation. Stratigraphy and fluorescent interferences appear to be the major issues that may prevent the sole use of a SCAPS LIF system. In addition, the technology is not presently applicable for other classes of contaminants. Further, the technology does not provide species-specific quantitation, and therefore cannot be used in lieu of conventional sampling and analysis if risk assessment needs or cleanup criteria must be met. As a screening technology to identify the extent of POL contamination, this technology has many advantages over conventional techniques. Site-specific considerations will determine whether the technology adds significant value to an investigation.



## Section 8

### Developer Forum

NCCOSC RDT&E Division agrees that the CSCT's findings are objectively correct; however, inordinate attention to limitations in Section 7 and elsewhere in this report detracts from the many advantages *in situ* field screening with this technology offers. The in-depth evaluation performed concurrently by the California EPA DTSC for their certification program establishes guidelines for usage that emphasize the many advantages this technology offers without excessive reference to limitations (Cal EPA DTSC, 1996).

NCCOSC RDT&E Division has developed or is in the process of developing additional sensors for use with the SCAPS CPT platform. These sensors are in various stages of development as of the date of this report. Some of these new sensors are LIF-based, utilizing wavelengths other than the nitrogen LIF system's 337-nm excitation source. As with the nitrogen LIF system, the detectors are designed to detect petroleum hydrocarbon contamination. Other sensors have been designed to measure soil moisture by time domain reflectometry; visually observe soil properties, including grain size, with the CPT-deployed video microscope; detect chlorinated hydrocarbons (solvents) using Raman spectroscopy; and detect metals using laser-induced breakdown spectroscopy. These sensors are further described below.

#### ***Xenon Chloride Laser***

The xenon chloride laser uses a laser source that emits 308-nm ultraviolet light rather than the 337 nm light used by the nitrogen laser system. The detector system and all other components of the LIF system using the xenon chloride laser are identical to the nitrogen system. The laser is contained in the SCAPS push vehicle, and the excitation and emission signals are transmitted by optical fibers. The use of a wavelength slightly deeper into the ultraviolet region of light is designed to cause stronger fluorescent response of the two-ringed PAHS. This should permit enhanced detection capabilities for lighter (more refined) petroleum distillates without compromising the detection capabilities of the heavier petroleum products. The xenon chloride laser has been field tested at three sites through May 1996.

#### ***Microchip Laser***

The microchip laser delivers ultraviolet light at 266-nm in order to induce fluorescence. Light at this wavelength is very poorly transmitted by available optical fibers, so the laser has been incorporated directly into the probe itself. The excitation light is emitted directly out of the optical window without the use of optical fibers. The induced fluorescence is coupled into an optical fiber and transmitted up into the SCAPS instrument room for detection and signal processing. Ultraviolet light at 266 nm has been shown in research studies to induce fluorescence in single-ring aromatic compounds.

#### ***Video Microscope***

NCCOSC RDT&E Division has developed and tested an *in situ* video microscope using the SCAPS CPT platform. A small video camera has been placed in the probe and optical fibers are used to transmit visible light for illumination from a source in the truck. The video microscope has the capability to resolve soil grains less than 10  $\mu\text{m}$  in diameter, and various magnifications are presently being evaluated for field use. The video signal is recorded with a standard VCR and is viewed in real time. Applications for the technology include grain size analysis, visual confirmation of strain gauge data, and visual identification of geologic contacts. Additionally, identification of pore size and the presence of cavities,

vertical structures, and other contaminant transport conduits are possible applications. The video microscope has been field deployed at three sites.

### ***Time Domain Reflectometry***

The time domain reflectometry (TDR) probe measures the bulk dielectric constant of the media (soil and/or water) with which it is in contact during a push. This data permits the estimation of the moisture content of the soil in the vadose as well as the saturated zone. Applications of this technology include identification of vadose zone and capillary zone thicknesses, identification of perched water zones, and as a secondary feature, changes in salinity of the pore water for identification of separate water bodies and salt water intrusion in coastal aquifers. NCCOSC RDT&E Division has field tested the TDR at two sites and is currently upgrading the probe design based on the initial results.

### ***Raman Spectroscopy***

NCCOSC PDT&E Division has developed a prototype Raman spectroscopy probe for detection of chlorinated solvents. Initial, bench-scale studies have indicated that the technology is feasible for DNAPL levels of contamination. Initial field tests have been conducted, and the data are currently under review.

### ***Laser-Induced Breakdown Spectroscopy***

NCCOSC RDT&E Division has developed a metals sensor for deployment with the SCAPS CPT platform based on a spectroscopic technique known as laser-induced breakdown spectroscopy (LIBS). Laser energy is transmitted from the platform via optical fibers and focused on soil particles immediately adjacent to the optical window of the probe. The focused energy vaporizes the soil and creates a micro plasma. The spectral emissions from the plasma are transmitted via optical fibers to a detector, which quantitatively measures the intensity of specific wavelengths from the plasma associated with different metals that may be present in the soil. The sensor has been field tested at three sites through May 1996. Applications include detection and delineation in real time, with fine-scale resolution, of metal impacted soil and groundwater.

### ***Other Applied Research***

The nitrogen LIF system and the sensors described above are being consolidated into a field screening and monitoring system to provide a broad spectrum of rapid site characterization capabilities. NCCOSC RDT&E Division is also working with Lawrence Livermore National Laboratory (LLNL) and California State Water Resources Control Board (SWRCB) officials to incorporate SCAPS in a series of demonstrations at military bases throughout California. The purpose of these demonstrations is to apply the ASTM Risk Based Corrective Action (RBCA) approach at petroleum contaminated sites. The SCAPS LIF and other sensors will be used at these sites to complete delineation, establish an existing baseline condition at the sites, and subsequently, monitor plume conditions to establish hydrocarbon plume stability and natural attenuation.

## Section 9

### Previous Field Trials

The following information was compiled from data provided by the NCCOSC RDT&E Division. All data sets from these field trials received a limited review by the verification entity, SNL, for the purpose of determining confidence bounds for the developer's claims. These field trials took place from 1993 to 1995 using one of three NCCOSC RDT&E Division-operated CPT platforms.

**Naval Station San Diego Fire Fighting Training Facility**, January and February 1994. A total of 22 pushes and 3 boreholes were advanced at the site, located in San Diego, California. Maximum push depth was 16.4 feet bgs. The target contaminant was *diesel fuel marine*. A total of 12 discrete soil samples were collected from the 3 borings and submitted to ATI for TPH and TRPH analysis. Site detection threshold was 106 mg/kg.

**Naval Amphibious Base Coronado, Abandoned Fuel Farm Site**, February and March, 1994. A total of 22 pushes and 3 hand auger borings were advanced at the site, located in Coronado, California. Maximum push depth was 15 feet bgs. The target contaminants were *diesel fuel and gasoline*. A total of 9 discrete soil samples were collected from the 3 hand auger borings and submitted to ATI for TPH and TRPH analysis. Site detection threshold was 285 mg/kg.

**Naval Air Station Alameda Site 13, Old Refinery Site**, March and April 1994. A total of 45 pushes and 8 boreholes were advanced at the site, located in Alameda, California. Maximum push depth was 22 feet bgs. The target contaminants were *gasoline, JP-5, and refinery waste*. A total of 49 samples were collected from the 8 borings and submitted to ATI for TPH and TPRH analysis and secondary classification. Site detection threshold was 137 mg/kg.

**Marine Corps Air Station Yuma, CERCLA AOC7 Site**, June 1994. A total of 29 pushes and 4 boreholes were advanced at the site, located in Yuma, Arizona. Maximum push depth was 72 feet bgs. The target contaminants were *JP-5, diesel fuel, and gasoline*. Site detection threshold was 898 mg/kg. The detection threshold was high, reportedly due to errors in the calibration procedure. The site also contained significant calcium carbonate layers, The calcium carbonate strongly fluoresced at 337 nm, the SCAPS LIF excitation wavelength, but during post-processing of the data it was possible to screen out the calcium carbonate fluorescence response from PAH fluorescent response by examining fluorescence spectra.

**Marine Corps Air Station Camp Pendleton, Ground Control Approach Facility**, June and July 1994. A total of 25 pushes and 4 boreholes were advanced at the site located in Camp Pendleton, California. Maximum push depth was 17.7 feet bgs. The target contaminant was *diesel fuel* from a surface spill. The Marine Corps had excavated visually impacted soil and wanted confirmation that all contaminant had been removed. The SCAPS LIF found no contamination. A total of 14 discrete soil samples were collected and submitted to ATI for confirmatory analysis. ATI found no contamination above 10 mg/kg. Site detection threshold was 745 mg/kg.

**Naval Air Station North Island, Underground Storage Tank 489 Site**, July and August 1994. A total of 25 pushes and 4 boreholes were advanced at the site, located in San Diego County. Maximum push depth was 30.8 feet bgs. The target contaminant was *diesel fuel*. A total of 26 discrete samples were collected from the 4 HSA borings and submitted to ATI for TPH and TRPH analysis. Site detection

threshold was 286 mg/kg. At this site, the wrong calibrant fuel was used and fluorescing minerals were present in the background.

**Guadalupe Oil Field**, August 1994. A total of 36 pushes and 4 boreholes were advanced at the UNOCAL Guadalupe Oil Field located in San Luis Obispo County, California. Maximum push depth was 101 feet bgs. The target contaminant was *oil field diluent*, a light nonaqueous phase liquid, that had been released throughout the oil field. Soils encountered during pushes were dune sands and silty sands. A total of 23 discrete soil samples were collected from the 4 borings and submitted to ATI for TPH and TRPH analysis. Site detection threshold was 90 mg/kg.

**Naval Training Center San Diego, Former Auto Hobby Shop**, November 1994. A total of 16 pushes and 3 boreholes were advanced at the site located in San Diego, California. Maximum push depth was 18.8 feet bgs. The target contaminant was *used motor oil* from a leaking underground storage tank. A total of 19 discrete soil samples were collected and submitted to ATI for TPH and TRPH analysis. Site detection threshold was 1141 mg/kg. From the notes it appears the wrong calibrant was used to determine the site detection threshold.

## Section 10

### References

- Analytical Technologies, Inc. (ATI). 1995. ATI-SD SOP 605. Hydrocarbon Characterization /Fuel Fingerprint Analysis by GC-FID Standard Operating Procedure. Revision 6.0. Revised March 1995.
- ATI. 1994. ATI Quality Assurance Manual. Revision 5.0. Revised November 1994.
- ATI. 1993a. ATI-SD SOP 421. Sub-Sampling and Compositing Soil Samples for VOA and Non-VOA Analyses Standard Operating Procedure. Revision 3. Revised June 1993.
- ATI. 1993b. ATI-SD SOP 803. Determination of Total Recoverable Petroleum Hydrocarbons by Infrared Spectrophotometry Standard Operating Procedure. Revision 1. Revised September 1993.
- California Environmental Protection Agency Department of Toxic Substances Control. 1996. Draft Hazardous Waste Technology Certification Program Evaluation Report, Site Characterization and Analysis Penetrometer System with Laser-Induced Fluoremetry as an In-situ Field Screening Technology for the Detection of PNA-containing Petroleum Hydrocarbons. May 1996.
- CEIMIC. 1996. Letter to Stang, PRC Environmental Management, Inc., re: two samples lost at ATI-SD. From Leslie Getman, CEIMIC (formerly ATI-SD). February 28, 1996.
- Los Alamos National Laboratory (LANL), 1991. Schroeder, J.D., Booth, S.R., and Trocki, L.K., "Cost Effectiveness of the Site Characterization and Analysis Penetrometer System." Los Alamos National Laboratory Report LA-UR-91-4016, submitted to Department of Energy. December 1991.
- PRC Environmental Management, Inc. (PRC). 1994. "Draft Site Inspection Report for Installation Restoration Program Site 22 - Aboveground Fuel Farm," NCBC Port Hueneme. July 1, 1994.
- PRC. 1995a. Laser Induced Fluorometry/Cone Penetrometer Technology Demonstration Plan at the Hydrocarbon National Test Site, Naval Construction Battalion Center Port Hueneme, California. Prepared for U.S. Environmental Protection Agency, Office of Research and Development, Environmental Systems Monitoring Laboratory-Las Vegas, Consortium for Site Characterization Technology. May 1995.
- PRC. 1995b. LIF/CPT Technology Predemonstration and Demonstration Summary Report, NCBC Port Hueneme Fuel Farm-County of Ventura Boring Permit E-575, Contract N66001-94-D0141, Delivery Order 0003. July 10, 1995.
- PRC. 1995c. Addendum to the Laser Induced Fluorometry/Cone Penetrometer Technology Demonstration Plan at the Arid Demonstration Site, Sandia National Laboratories Steam Plant Tank Farm, Albuquerque, New Mexico. Prepared for U.S. Environmental Protection Agency, Office of Research and Development, National Exposure Research Laboratory, Characterization Research Division-Las Vegas, Consortium for Site Characterization Technology. October 1995.

- PRC. 1995d. LIF/CPT Technology Predemonstration and Demonstration Summary Report, Arid Demonstration Site, Sandia National Laboratories Above Ground Fuel Farm, Contract N66001-94-D0141, Delivery Order 0006. December 20, 1995.
- Robertson, P.K, 1986. *In situ* Testing and Its Application to Foundation Engineering, 1985 Canadian Geotechnical Colloquium. Canadian Technical Journal, Vol. 23, No. 23, pp 573-594.
- U.S. Environmental Protection Agency (EPA). 1995. Test Methods for Evaluating Solid Waste, Physical/Chemical Methods (SW-846). Revision 3. January 1995.
- EPA. 1994. "Guidance Manual for the Preparation of Site Characterization Technology Demonstration Plans - Protocol I." Version 3.0. December 25, 1994.
- EPA. 1989a. "Preparing Perfect Project Plans." Risk Reduction Engineering Laboratory, Office of Research and Development. Cincinnati, Ohio. EPA/600/9-89/087. October 1989.
- USEPA. 1989b. "Methods for the Attainment of Cleanup Standards, Volume 1: Soils and Solid Media." Office of Policy, Planning, and Evaluation, EPA 220/02-89-042. October 1989.

**Appendix A**  
**Reference Laboratory Data**

**Table A-1  
Reference Laboratory Results of Soil Samples  
NCBC Port Hueneme**

Sample Number	Depth	Date	TRPH Concentration (mg/kg)	TPH Concentration (mg/kg)	LIF/Lab Result
PHDB21-1	2.5-3.0'	5-17-95	<1	<5.0	ND/ND
PHDB21-2	3.0-3.5'	5-17-95	4	<5.0	ND/ND
PHDB21-3	4.5-5.0'	5-17-95	<1	<5.0	ND/ND
PHDB21-4	5.0-5.5'	5-17-95	<1	<5.0	ND/ND
PHDB21-5	6.5-7.0'	5-17-95	4	<5.0	ND/ND
PHDB21-6	7.0-7.5'	5-17-95	<1	<5.0	ND/ND
PHDB21-7	8.5-9.0'	5-17-95	<1	<5.0	ND/ND
PHDB21-8	9.0-9.5'	5-17-95	2	<5.0	ND/ND
PHDB21-9	10.5-11.0'	5-17-95	2	<5.0	ND/ND
PHDB21-10	11.0-11.5'	5-17-95	2	<5.0	D/ND
PHDB21-11	12.5-13.0'	5-17-95	21900 (Dup 22500)	18000 (Dup 18000)	D/D
PHDB21-12	13.0-13.5'	5-17-95	18500 (Dup 17400)	15000 (Dup 4000)	D/D
PHDB21-13	15.5-16.0'	5-17-95	28	<5.0	ND/ND
PHDB21-14	16.0-16.5'	5-17-95	18	<5.0	ND/ND
PHDB21-15	18.5-19'	5-17-95	11	<5.0	ND/ND
PHDB22-1	2.5-3.0'	5-17-95	<1	<5.0	ND/ND
PHDB22-2	3.0-3.5'	5-17-95	<1	<5.0	ND/ND
PHDB22-3	4.5-5.0'	5-17-95	<1	<5.0	ND/ND
PHDB22-4	5.0-5.5'	5-17-95	<1	<5.0	ND/ND
PHDB22-5	7.0-7.5'	5-17-95	<1	<5.0	ND/ND
PHDB22-6	7.5-8.0'	5-17-95	<1	<5.0	ND/ND
PHDB22-7	8.5-9.0'	5-17-95	<1	<5.0	ND/ND
PHDB22-8	9.0-9.5'	5-17-95	<1	<5.0	ND/ND
PHDB22-9	10.5-11.0'	5-17-95	<1	<5.0	ND/ND
PHDB22-10	11.0-11.5'	5-17-95	<1	<5.0	ND/ND
PHDB22-11	12.5-13.0'	5-17-95	4	<5.0	ND/ND
PHDB22-12	13.0-13.5'	5-17-95	<1	<5.0	ND/ND
PHDB22-13	14.5-15.0'	5-17-95	<1	<5.0	ND/ND
PHDB22-14	15.0-15.5'	5-17-95	<1	<5.0	ND/ND
PHDB22-15	16.5-17.0'	5-17-95	<1	<5.0	ND/ND
PHDB22-16	17.0-17.5'	5-17-95	<1	<5.0	ND/ND
PHDB22-17	19.0-19.5'	5-17-95	6	<5.0	ND/ND
PHDB23-1	2.5-3.0'	5-18-95	<1	<5.0	ND/ND
PHDB23-2	3.0-3.5'	5-18-95	<1	<5.0	ND/ND
PHDB23-3	4.5-5.0'	5-18-95	14	<5.0	ND/ND
PHDB23-4	6.5-7.0'	5-18-95	<1	<5.0	ND/ND
PHDB23-5	7.0-7.5'	5-18-95	<1	<5.0	ND/ND
PHDB23-6	8.5-9.0'	5-18-95	<1	<5.0	ND/ND
PHDB23-7	9.0-9.5'	5-18-95	<1	<5.0	ND/ND
PHDB23-8	10.5-11.0'	5-18-95	53	9.6	ND/ND
PHDB23-9	11.0-11.5'	5-18-95	<1	<5.0	ND/ND
PHDB23-10	12.5-13.0'	5-18-95	16200 (Dup 18300)	16000 (Dup 16000)	D/D <sup>d</sup>
PHDB23-11	13.0-13.5'	5-18-95	24200 (Dup 26500)	19000 (Dup 23000)	D/D <sup>d</sup>
PHDB23-12	14.0-14.5'	5-18-95	6460 (Dup 6160)	7000 (Dup 5800)	D/D <sup>d</sup>
PHDB23-13	14.5-15.0'	5-18-95	22	29	D/ND <sup>d</sup>

<sup>d</sup> indicates samples for which single point test measurements were used to determine the depth discrepancy between discrete soil samples and *in situ* LIF measurements. Depth of discrete samples was adjusted 6 in to correlate with *in situ* LIF measurements.



**Table A-1 (continued)**  
**Reference Laboratory Results of Soil Samples**  
**NCBC Port Hueneme**

Sample Number	Depth	Date	TRPH Concentration (mg/kg)	TPH Concentration (mg/kg)	LIF/Lab Result
PHDB23-14	17.0-17.5'	5-18-95	224	89	ND/D
PHDB23-15	17.5-18.0'	5-18-95	2	<5.0	ND/ND
PHDB23-16	18.5-19.0'	5-18-95	5	<5.0	ND/ND
PHDB24-1	2.5-3.0'	5-18-95	81	77	ND/ND
PHDB24-2	3.0-3.5'	5-18-95	<1	<5.0	ND/ND
PHDB24-4	4.5-5.0'	5-18-95	<1	<5.0	ND/ND
PHDB24-5	5.0-5.5'	5-18-95	<1	<5.0	ND/ND
PHDB24-7	6.5-7.0'	5-18-95	<1	<5.0	ND/ND
PHDB24-8	7.0-7.5'	5-18-95	<1	<5.0	ND/ND
PHDB24-9	8.5-9.0'	5-18-95	<1	<5.0	ND/ND
PHDB24-10	9.0-9.5'	5-18-95	<1	<5.0	ND/ND
PHDB24-12	10.5-11.0'	5-18-95	<1	<5.0	ND/ND
PHDB24-13	11.0-11.5'	5-18-95	<1	<5.0	ND/ND
PHDB24-14	12.5-13.0'	5-18-95	<1	<5.0	ND/ND
PHDB24-15	13.0-13.5'	5-18-95	<1	<5.0	ND/ND
PHDB24-17	14.5-15.0'	5-18-95	17	<5.0	ND/ND
PHDB24-18	15.0-15.5'	5-18-95	<1	<5.0	ND/ND
PHDB24-19	16.0-16.5'	5-18-95	<1	<5.0	ND/ND
PHDB24-20	16.5-17.0'	5-18-95	11	<5.0	ND/ND
PHDB24-21	19.0-19.5'	5-18-95	<1	<5.0	ND/ND
PHDB25-1	3.0-3.5'	5-19-95	<1	<5.0	ND/ND
PHDB25-2	3.5-4.0'	5-19-95	<1	<5.0	ND/ND
PHDB25-3	4.5-5.0'	5-19-95	<1	<5.0	ND/ND
PHDB25-4	5.0-5.5'	5-19-95	<1	<5.0	ND/ND
PHDB25-5	6.5-7.01	5-19-95	<1	<5.0	ND/ND
PHDB25-6	7.0-7.5'	5-19-95	<1	<5.0	ND/ND
PHDB25-7	8.5-9.0'	5-19-95	<1	<5.0	ND/ND
PHDB25-8	9.0-9.5'	5-19-95	<1	<5.0	ND/ND
PHDB25-9	11.0-11.5'	5-19-95	25	51	ND/ND
PHDB25-10	12.5-13.0'	5-19-95	748	1100	ND/D
PHDB25-11	13.0-13.5'	5-19-95	5620	6400	ND/D
PHDB25-12	14.5-15.0'	5-19-95	9340 (Dup 13600)	16000 (Dup 15000)	D/D
PHDB25-13	15.0-15.5'	5-19-95	172 (Dup 264)	150 (Dup 190)	D/D
PHDB25-14	17.0-17.5'	5-19-95	28	16	ND/ND
PHDB25-15	17.5-18.0'	5-19-95	1	11	ND/ND
PHDB25-16	19.5-20.0'	5-19-95	9	<5.0	ND/ND
PHDB26-1	2.5-3.0'	5-19-95	31	11	ND/ND
PHDB26-2	4.5-5.0'	5-19-95	<1	<5.0	ND/ND
PHDB26-3	5.0-5.5'	5-19-95	<1	<5.0	ND/ND
PHDB26-4	6.5-7.0'	5-19-95	<1	<5.0	ND/ND
PHDB26-5	7.0-7.5'	5-19-95	<1	<5.0	ND/ND
PHDB26-6	8.5-9.0'	5-19-95	<1	<5.0	ND/ND
PHDB26-7	9.0-9.5'	5-19-95	<1	<5.0	ND/ND
PHDB26-8	10.5-11.0'	5-19-95	<1	<5.0	ND/ND
PHDB26-9	11.0-11.5'	5-19-95	<1	<5.0	ND/ND
PHDB26-10	12.5-13.0'	5-19-95	<1	<5.0	ND/ND
PHDB26-11	13.0-13.5'	5-19-95	36	41	ND/ND
PHDB26-12	15.0-15.5'	5-19-95	8600	7900	D/D

**Table A-1 (continued)**  
**Reference Laboratory Results of Soil Samples**  
**NCBC Port Hueneme**

Sample Number	Depth	Date	TRPH Concentration (mg/kg)	TPH Concentration (mg/kg)	LIF/Lab Result
PHDB26-13	15.5-16.0'	5-19-95	3540	2800	D/D
PHDB26-14	17.0-17.5'	5-19-95	229	250	ND/D
PHDB26-15	17.5-18.0'	5-19-95	145	170	ND/D
PHDB26-16	19.0-19.5'	5-19-95	<1	<5.0	ND/ND
PHDB26-17	19.5-20.0'	5-19-95	<1	<5.0	ND/ND
PHDB27-1	2.5-3.0'	5-22-95	2	<5.0	ND/ND
PHDB27-2	3.0-3.5'	5-22-95	2	<5.0	ND/ND
PHDB27-3	4.5-5.0'	5-22-95	<1	<5.0	ND/ND
PHDB27-4	5.0-5.5'	5-22-95	<1	<5.0	ND/ND
PHDB27-5	6.5-7.0'	5-22-95	4	<5.0	ND/ND
PHDB27-6	7.0-7.5'	5-22-95	9	<5.0	ND/ND
PHDB27-7	8.5-9.0'	5-22-95	<1	<5.0	ND/ND
PHDB27-8	9.0-9.5'	5-22-95	1	<5.0	ND/ND
PHDB27-10	10.5-11.0'	5-22-95	<1	<5.0	ND/ND
PHDB27-11	11.0-11.5'	5-22-95	<1	<5.0	ND/ND
PHDB27-12	12.5-13.0'	5-22-95	<1	<5.0	ND/ND
PHDB27-13	13.0-13.5'	5-22-95	<1	<5.0	ND/ND
PHDB27-15	14.5-15.0'	5-22-95	<1	<5.0	ND/ND
PHDB27-16	15.0-15.5'	5-22-95	3	<5.0	ND/ND
PHDB27-17	16.5-17.0'	5-22-95	1	<5.0	ND/ND
PHDB27-19	19.0-19.5'	5-22-95	2	<5.0	ND/ND
PHDB28-1	2.5-3.0'	5-22-95	34	9.8	ND/ND
PHDB28-2	4.5-5.0'	5-22-95	2	<5.0	ND/ND
PHDB28-3	5.0-5.5'	5-22-95	2	<5.0	ND/ND
PHDB28-4	6.5-7.0'	5-22-95	3	<5.0	ND/ND
PHDB28-5	7.0-7.5'	5-22-95	4	<5.0	ND/ND
PHDB28-6	8.5-9.0'	5-22-95	3	<5.0	ND/ND
PHDB28-7	9.0-9.5'	5-22-95	3	<5.0	ND/ND
PHDB28-8	10.5-11.0'	5-22-95	5	<5.0	ND/ND
PHDB28-9	11.0-11.5'	5-22-95	<1	<5.0	ND/ND
PHDB28-11	12.5-13.0'	5-22-95	2	<5.0	ND/ND
PHDB28-12	13.0-13.5'	5-22-95	<1	<5.0	ND/D
PHDB28-13	14.5-15.0'	5-22-95	1100 (Dup 800)	780 (Dup 920)	ND/D <sup>d</sup>
PHDB28-14	15.0-15.5'	5-22-95	1800 (Dup 2100)	2900 (Dup 3400)	D/D <sup>d</sup>
PHDB28-15	15.5-16.0'	5-22-95	100	250	D/D <sup>d</sup>
PHDB28-16	17.5-18.0'	5-22-95	13	<5.0	ND/ND
PHDB28-17	18.0-18.5'	5-22-95	9	<5.0	ND/ND

Notes:

1. TRPH indicates total recoverable petroleum hydrocarbons, analyzed by EPA method 418.1.
2. TPH indicates total petroleum hydrocarbons, analyzed by the California Department of Health Services method 8015-modified.
3. mg/kg = milligrams per kilogram.
4. Dup indicates duplicate analysis performed by separate analysis of split sample following homogenization.
5. Accuracy in depth is estimated to be within 3 inches in the vadose zone, and 6 inches in the saturated zone.
6. <sup>d</sup> indicates samples for which single point test measurement results were used to determine depth discrepancy between discrete soil samples and *in situ* measurements. Depth of discrete samples was adjusted 4 in to correlate with *in situ* LIF measurements.

**Table A-2**  
**Reference Laboratory Results of Soil Samples**  
**SNL Tank Farm**

Sample Number	Depth (bgs)	Date	TRPH Concentration (mg/kg)	TPH Concentration (mg/kg)	LIF/Lab Result
SNLDB10-1	2.75-3.0'	11-6-95	60	23	ND/ND <sup>s</sup>
SNLDB10-2	3.25-3.5'	11-6-95	25	<5	ND/ND <sup>s</sup>
SNLDB10-3	4.75-5.0'	11-6-95	89	99	ND/D <sup>s</sup>
SNLDB10-4	5.25-5.5'	11-6-95	42	54	ND/ND <sup>s</sup>
SNLDB10-5	6.75-7.0'	11-6-95	71	70	ND/ND <sup>s</sup>
SNLDB10-6	7.25-7.5'	11-6-95	162	150	ND/D <sup>s</sup>
SNLDB10-7	8.75-9.0'	11-6-95	17	<5	ND/ND <sup>s</sup>
SNLDB10-8	9.25-9.5'	11-6-95	11	14	ND/ND <sup>s</sup>
SNLDB10-9	10.75-11.0'	11-6-95	27	24	ND/ND <sup>s</sup>
SNLDB10-10	11.25-11.5'	11-6-95	22	27	ND/ND <sup>s</sup>
SNLDB10-11	12.75-13.0'	11-6-95	206	270	ND/D <sup>s</sup>
SNLDB10-12	13.25-13.5'	11-6-95	1,470	1,500	ND/D <sup>s</sup>
SNLDB10-13	14.75-15.0'	11-6-95	4,870	5,000	D/D
SNLDB10-14	15.25-15.5'	11-6-95	7,600	6,600	D/D
SNLDB10-15	16.75-17.0'	11-6-95	14,300	21,000	D/D
SNLDB10-16	17.25-17.5'	11-6-95	8,500	13,000	D/D
SNLDB10-17	18.75-19.0'	11-6-95	25,600	26,000	D/D
SNLDB10-18	19.25-19.5'	11-6-95	25,800	28,000	D/D
SNLDB10-19	20.75-21.0'	11-6-95	14,700	14,000	D/D
SNLDB10-20	21.25-21.5'	11-6-95	5,790	6,300	D/D
SNLDB10-21	22.75-23.0'	11-6-95	6,530	6,900	D/D
SNLDB10-22	23.25-23.5'	11-6-95	8,560	9,100	D/D
SNLDB10-23	24.75-25.0'	11-6-95	5,100	4,200	D/D
SNLDB10-24	25.25-25.5'	11-6-95	5,400	4,500	D/D
SNLDB10-25	26.75-27.0'	11-6-95	11,200	9,800	D/D
SNLDB10-26	28.75-29.0'	11-6-95	20,400	20,000	D/D
SNLDB10-27	29.25-29.5'	11-6-95	24,900	23,000	D/D
SNLDB10-28	30.75-31.0'	11-6-95	7,330	6,600	D/D
SNLDB10-29	31.25-31.5'	11-6-95	3,520	3,100	D/D
SNLDB10-30	32.75-33.0'	11-6-95	1,340	1,400	D/D
SNLDB10-31	33.25-33.5'	11-6-95	28,400	35,000	D/D
SNLDB10-32	34.75-35.0'	11-6-95	25,600	24,000	D/D
SNLDB10-33	35.25-35.5'	11-6-95	18,200	18,000	D/D
SNLDB10-34	36.75-37.0'	11-6-95	9,620	10,000	D/D
SNLDB10-35	37.25-37.5'	11-6-95	26,200	21,000	D/D
SNLDB10-36	38.75-39.0'	11-6-95	32,200	28,000	D/D
SNLDB10-37	39.25-39.5'	11-6-95	21,700	21,000	D/D

<sup>s</sup> indicates LIF result was changed from detect (D) to nondetect (ND) based on review of spectrum which indicated strong carbonate fluorescence. In some cases, the strong carbonate fluorescence signal masked any hydrocarbon presence, resulting in a false negative (ND/D).

**Table A-2 (continued)**  
**Reference Laboratory Results of Soil Samples**  
**SNL Tank Farm**

Sample Number	Depth (bgs)	Date	TRPH Concentration (mg/kg)	TPH Concentration (mg/kg)	LIF/Lab Result
SNLDB10-38	40.75-41.0'	11-6-95	15,800	14,000	D/D
SNLDB10-39	41.25-41.5'	11-6-95	8,440	9,700	D/D
SNLDB10-40	42.75-43.0'	11-6-95	9,500 (Dup 9,160)	12,000 (Dup 12,000)	D/D
SNLDB10-41	43.25-43.5'	11-6-95	15,000	18,000	D/D
SNLDB10-42	44.75-45.0'	11-6-95	7,500	12,000	D/D
SNLDB10-43	45.25-45.5'	11-6-95	11,000	9,900	D/D
SNLDB10-44	46.75-47.0'	11-6-95	13,000	15,000	D/D
SNLDB10-45	47.25-47.5'	11-6-95	19,000	23,000	D/D
SNLDB10-46	48.75-49.0'	11-6-95	26,000	32,000	D/D
SNLDB10-47	49.25-49.5'	11-6-95	8,200	14,000	D/D
SNLDB10-48	50.75-51.0'	11-6-95	13,000	14,000	D/D
SNLDB10-49	51.25-51.5'	11-6-95	15,000	27,000	D/D
SNLDB10-50	52.75-53.0'	11-6-95	17,000	12,000	D/D
SNLDB10-51	53.25-53.5'	11-6-95	5,500	8,500	D/D
SNLDB11-1	6.0-6.25'	11-7-95	9.7	19	ND/ND <sup>s</sup>
SNLDB11-2	10.75-11.0'	11-7-95	9.0	<5	ND/ND <sup>s</sup>
SNLDB11-3	11.25-11.5'	11-7-95	< 1	<5	ND/ND <sup>s</sup>
SNLDB11-4	16.0-16.25'	11-7-95	3,470	2,700	ND/D
SNLDB11-5	20.75-21.0'	11-7-95	13,000	11,000	D/D
SNLDB11-6	21.25-21.5'	11-7-95	15,200	21,000	D/D
SNLDB11-7	25.75-26.0'	11-7-95	12,000	10,000	D/D
SNLDB11-8	26.25-26.5'	11-7-95	22,300	21,000	D/D
SNLDB11-9	30.75-31.0'	11-7-95	18,200	17,000	D/D
SNLDB11-10	33.25-33.5'	11-7-95	31,000	21,000	D/D
SNLDB11-11	35.75-36.0'	11-7-95	19,800	19,000	D/D
SNLDB11-12	36.25-36.5'	11-7-95	22,200	21,000	D/D
SNLDB11-13	40.75-41.0'	11-7-95	26,200	24,000	D/D
SNLDB11-14	41.25-41.5'	11-7-95	5,160	4,200	D/D
SNLDB11-15	42.75-43.0'	11-7-95	20,600	22,000	D/D
SNLDB11-16	43.25-43.5'	11-7-95	18,300	22,000	D/D
SNLDB11-17	44.75-45.0'	11-7-95	7,030	14,000	D/D
SNLDB11-18	45.25-45.5'	11-7-95	6,240	10,000	D/D
SNLDB11-19	46.75-47.0'	11-7-95	11,900	13,000	D/D
SNLDB11-20	47.25-47.5'	11-7-95	25,400	29,000	D/D
SNLDB11-21	48.25-48.5'	11-7-95	17,200	29,000	D/D
SNLDB11-22	48.75-49.0'	11-7-95	44,600	39,000	D/D
SNLDB11-23	49.25-49.5'	11-7-95	7,340	8,900	D/D
SNLDB11-24	50.75-51.0'	11-7-95	14,700	14,000	D/D
SNLDB11-25	51.25-51.5'	11-7-95	23,600	25,000	D/D
SNLDB11-26	52.75-53.0'	11-7-95	16,100	16,000	D/D
SNLDB11-27	53.25-53.5'	11-7-95	13,600	13,000	D/D
SNLDB11-28	55.0-55.25'	11-7-95	21,400	20,000	D/D

<sup>s</sup> indicates LIF result was changed from detect (D) to nondetect (ND) based on review of spectrum which indicated strong carbonate fluorescence.

**Table A-2 (continued)**  
**Reference Laboratory Results of Soil Samples**  
**SNL Tank Farm**

Sample Number	Depth (bgs)	Date	TRPH Concentration (mg/kg)	TPH Concentration (mg/kg)	LIF/Lab Result
SNLDB12-1	2.75-3.0'	11-8-95	3	<5	ND/ND
SNLDB12-2	3.25-3.5'	11-8-95	2	<5	ND/ND
SNLDB12-3	6.0-6.25'	11-8-95	<1	<5	ND/ND
SNLDB12-5	11.25-11.5'	11-8-95	<1	<5	ND/ND
SNLDB12-7	16.0-16.25'	11-8-95	<1	<5	ND/ND
SNLDB12-9	21.0-21.25'	11-8-95	2	<5	ND/ND
SNLDB12-11	26.25-26.5'	11-8-95	2	<5	ND/ND
SNLDB12-12	26.75-27.0'	11-8-95	<1	<5	ND/ND
SNLDB12-13	31.0-31.25'	11-8-95	<1	<5	ND/ND
SNLDB12-15	36.5-36.75'	11-8-95	<1	<5	ND/ND
SNLDB12-17	41.0-41.25'	11-8-95	<1	<5	ND/ND
SNLDB12-19	43.0-43.25'	11-8-95	<1	<5	ND/ND
SNLDB12-20	49.0-49.5'	11-8-95	<1	<5	ND/ND

1. TRPH indicates total recoverable petroleum hydrocarbons, analyzed by EPA method 418.1.
2. TPH indicates total petroleum hydrocarbons, analyzed by the California Department of Health Services method 8015-modified.
3. mg/kg = milligrams per kilogram.
4. Dup indicates duplicate analysis performed by separate analysis of split sample following homogenization.

**Appendix B**  
**SCAPS LIF Field Data Logs**

**Appendix C**  
**SCAPS LIF Draft EMMC Method**

## DRAFT METHOD

### IN SITU FIELD SCREENING OF PETROLEUM HYDROCARBONS IN SOIL AND GROUNDWATER USING A PENETROMETER-DEPLOYED FLUOROMETRIC SENSOR

#### 1.0 SCOPE AND APPLICATION

1.1 This field screening method is used to rapidly determine the location and relative extent of subsurface petroleum hydrocarbon contamination in soil and groundwater. The method can be used to detect contaminants throughout the vadose, capillary fringe, and saturated zones to depths of up to 50 meters. No physical sampling is required by this method. Analytical measurements are collected *in situ*. A partial list of the analytes for which this method is appropriate includes:

mineral oil	gasoline	tar	jet fuel
kerosene	diesel fuel	asphaltum	aviation fuel
fuel oil	lubricating oil	hydraulic oil	petroleum distillates

1.2 Method sensitivity can vary from the low parts-per-million (ppm) range to parts-per-thousand depending on a number of critical factors including soil matrix, choice of excitation source, optical collection efficiency, and the specific analyte targeted.

1.3 The method yields qualitative and semiquantitative results, making it appropriate for preliminary assessments of contaminant distribution as in environmental field screening applications.

#### 2.0 SUMMARY OF METHOD

2.1 This method provides an overview and guidelines for the use of an integrated Laser Induced Fluorescence sensor/cone penetrometer testing (LIF/CPT) to obtain *in situ* measurements of hydrocarbon contamination in soil. Optional procedures for calibration and data analysis are also provided.

2.2 A LIF sensor is used to detect petroleum products by measuring the fluorescence energy emitted when aromatic or polycyclic aromatic constituents are excited by intense ultraviolet radiation. The truck-mounted penetrometer system provides a mobile platform from which the LIF sensor is deployed as a means of performing remote spectroscopy in soil. The sensor is coupled to the penetrometer through a set of optical fibers that transmit the excitation energy to a sapphire window located near the penetrometer tip, and collect and transmit the return signal back to the surface for analysis.

2.3 Fluorescence measurements can be obtained at subsurface depths of up to 50 meters when the sensor is used in conjunction with a standard 20-ton penetrometer vehicle. Typically, data are collected at a rate of one fluorescence spectrum every 2 seconds. This rate



provides a vertical spatial resolution of less than 4 cm when the penetrometer is driven at a standard rate of 1 m/min.

2.4 Geotechnical sensors are normally integrated with the LIF sensor probe to facilitate hydrogeological and stratigraphic analyses of the soil matrix.

### **3.0 DEFINITIONS**

3.1 LIF: laser-induced fluorescence

3.2 Penetrometer: an instrument in the form of a cylindrical rod that is hydraulically pressed into soil to acquire subsurface measurements of penetration resistance. Used for cone penetrometer testing (CPT). Also called cone penetrometer, friction-cone penetrometer.

3.3 POL: petroleum, oil, lubricant. Used in reference to any petroleum product or derivative.

3.4 Push rods: cylindrical rods with threaded tips that are joined to advance the penetrometer probe into the ground.

3.5 UV: ultraviolet

### **4.0 SPECTRAL INTERFERENCES**

4.1 The LIF sensor is sensitive to any materials that fluoresce when excited by the laser light source. Although the method is intended to specifically target petroleum hydrocarbons, the excitation energy produced by the laser excitation source may cause other substances to fluoresce as well. It is possible that the sensor could respond to fluorescence originating from non-POL sources. For example, many common fluorescent minerals can produce a measurable LIF signal. In rare instances, non-POL fluorescence may also originate in naturally occurring organic material. Other non-POL fluorescers may be found in the subsurface environment as a result of human activity. De-icing agents, antifreeze additives, and many detergent products are all known to fluoresce strongly.

4.2 The potential presence of fluorescence emission from nontarget (non-POL) analytes within the soil matrix must be considered when assessing data generated by this method. In some instances, the inability to discriminate between POL fluorescence and non-POL fluorescence could lead to a false positive determination of the presence of POL contaminants.

4.3 By analysis of the fluorescence emission spectral information, it is often possible to discriminate between POL and non-POL fluorescence. The LIF sensor system uses a multichannel detection scheme to capture a complete fluorescence emission spectrum at selected (or all) points along the push. The spectral features associated with a particular data set can be used to uniquely distinguish POL fluorescence from potential interferents. The advantage of this approach over methods that rely on single-channel measurements of fluorescence intensity is that spectral features are obtained that can be used to associate the signal with a specific petroleum class, mineral substance, or other material.

## 5.0 SAFETY

This section describes the safety concerns for staff operating the Site Characterization and Penetrometer System (SCAPS) cone penetrometer testing (CPT) technology that go beyond the scope of routine laboratory practices. It is divided into subsections corresponding with the four separate time periods that typically occur during a routine day of SCAPS CPT operations. The last subsection deals with less frequent operations.

5.1 Each morning, the crew chief must enter the cab and power up the CPT vehicle. The steps and handles leading to the cab are usually wet with dew and present a slip and fall hazard. The crew is generally busy loading supplies for the day onto the CPT itself as well as the support vehicle. The supplies consist of bags of cement and bentonite, 55-gallon drums, 5-gallon buckets of water, and nitrogen cylinders. All of these present the potential to injure the crew's backs and joints. Possible injuries from dropping or tripping while carrying any of these heavy items is also a concern.

5.2 While stationing the vehicle for a push, it is necessary for a crew member to direct the crew chief as he maneuvers the rig into position. Both the crew chief and the person directing him must be acutely aware of their relative positions to avoid mishaps. Obstacles, including an uneven ground surface, can present a trip hazard. After the CPT truck is positioned over the push location, the push room access ladder is typically deployed. Some crew members use the ladder at least twice during each push to enter and exit the CPT. General ladder safety practices to avoid slips, twists, and falls must be followed. The support vehicle is then brought alongside with the grout supplies and equipment. The crew member parking the vehicle must approach slowly and position the truck carefully in relation to the ladder.

The crew member handling the CPT rods in the push room faces a foot injury hazard that would result from dropping one of the rods. Steel-toed safety shoes are a requirement for all crew members. Hard hats and safety glasses must be worn at all times except for when working in the data collection room. The technician (and any other crew members working in the data collection room) must follow standard laser operation safety procedures which typically involve wearing ultraviolet (UV) protective safety glasses. The quinine sulfate standard and other cuvettes used during the method are cleaned by the technician and the crew chief using paper wipes and ethanol. Since the flooring of the SCAPS CPT is steel, the ethanol is kept in a plastic, squeeze-dispensing container to avoid breakage if dropped.

A pinch or crushing hazard is presented by the platform located on the outside rear of the SCAPS CPT which holds the steam cleaner, wastewater drum, and nitrogen cylinders. This platform must be operated twice during each push. The space between the platform and the SCAPS CPT is at a height conducive to pinching fingers or arms. Special care must be taken by crew members operating the platform to keep feet clear of the heavy steel ramp that comes to rest on the ground.

A similar finger pinching hazard exists in association with the operation of the hydraulic grout pump tray. The grout for the abandonment of the push hole is mixed in a plastic container using a compressed air-powered tool. The grout pumping line in the CPT umbilical is purged using compressed air. Standard safety practices regarding the use of compressed air must be followed, chief among these being the protection of eyes during connection to and disconnection from the compressor. Protection is accomplished by the SCAPS CPT crew by holding the two quick connectors at waist level. While the grout is pumped, special care must

be taken to keep fingers and hands well away from the pump's impellers located below the base of the funnel. A constant awareness of the status and condition of the various hydraulic pressure lines during each push is important. Checking to make sure that lines are not pressurized before disconnection is required to avoid the hazard of being sprayed (especially in the face) with hydraulic fluid. The hoses are checked regularly for signs of wear that could lead to rupture.

5.3 After a push is complete, the SCAPS CPT truck and support vehicle must be repositioned to the next location. Repositioning can involve backing up, which presents hazards associated with limited visibility. The drivers of the SCAPS CPT and its support vehicle must not feel rushed during the operations. As the vehicles move to the next push, the technician in the data collection room uses metal picks, paper wipes, and ethanol to clean the probe, which has been placed in a bracket on the work bench. Since the vehicle is in motion at this time, the technician should take care not to puncture a finger with the pick or spill the ethanol as the probe is cleaned for the next push.

5.4 It is periodically necessary to change out the steam cleaning wastewater drum located on the rear platform either when it becomes full at a point in between pushes or at the end of a day in the field. In addition to the hazards associated with operation of the electric platform discussed in Subsection 5.2 above, a 55-gallon drum of wastewater weighs well in excess of 400 pounds and thereby presents several safety concerns. The changeout operation is best performed by two crew members working carefully together to avoid crushing a foot or hand by the drum during handling. The support vehicle is equipped with a hydraulic lift gate that presents a pinching hazard, but the lift gate can be used to minimize the distance over which the waste drum must be handled, both to be removed from the CPT and to be placed in the IDW storage area. The same safety parameters also apply to change out of the nitrogen gas cylinder.

## **6.0 EQUIPMENT AND SUPPLIES**

### **6.1 LASER INDUCED FLUORESCENCE (LIF) SENSOR**

The LIF sensor system consists of the following basic elements:

1. A laser excitation source operating in the UV range at one or more discrete wavelengths between 250 and 360 nm.
2. Optical fibers for carrying the excitation light to the optical window built into the penetrometer probe and for transmitting the resulting fluorescence emission back to the surface for detection and analysis.
3. A spectrograph or other dispersive element for performing spectral analysis on the emission signal.
4. An optical detector for quantifying the emission signal.
5. A data system for analyzing and storing spectral data.

## 6.2 TRUCK MOUNTED CONE PENETROMETER

6.2.1 An industry standard system employs a hydraulic ram mounted to a truck chassis so that a series of attached threaded rods can be pressed into the ground through an opening in the floor of the vehicle.

## 6.3 PENETROMETER WITH SPECTROSCOPIC VIEW PORT AND FIBER OPTIC INTERFACE

6.3.1 This is a standard penetrometer modified with a sapphire view port mounted on the side of the shaft. A set of optical fibers is fixed near the inside surface of the view port.

## 7.0 REAGENTS AND STANDARDS

7.1 Reagent-grade chemicals shall be used in all tests. Unless otherwise indicated, it is intended that all reagents shall conform to the specifications of the Committee on Analytical Reagents of the American Chemical Society, where such specifications are available. Other grades may be used, provided it is first ascertained that the reagent is of sufficient high purity to permit its use without lessening the accuracy of the determination.

### 7.2 QA STANDARDS

7.2.1 Choice of the check standard will depend on the specific excitation wavelength and target analyte. The check standard should fluoresce in the same wavelength range as the target analytes. A dilute solution of quinine sulfate is often a good choice because it has a high quantum efficiency, is chemically stable, preparation is reproducible, and it exhibits minimal photodegradation. The appropriate concentration of the check standard will depend on system sensitivity.

7.2.2 A 100 milliliter (ml) solution containing 1,000 ppm quinine sulfate is prepared as a primary standard as follows. Using an analytical balance that is accurate to +/- 0.0001 grams, weigh out 0.10 grams of quinine sulfate dehydrate (Chemical Abstract Service [CAS] no. 6119-70-6). Transfer to a 100 ml volumetric flask. Add 0.1 normal sulfuric acid to make 100 ml. This solution may be diluted to create solutions of lower concentration. The solution must be stored in amber-colored bottles and checked frequently for signs of degradation or evaporation.

7.2.3 A method blank may be prepared from a sample of clean dry soil. Fine to medium-grain sea sand is appropriate.

### 7.4 CALIBRATION STANDARDS

7.4.1 When calibration standards are used, they are prepared as a series of standard additions to soil samples representative of the analyte matrix. The added material should match the target POL analyte as closely as possible. One of the difficulties in establishing the target POL analyte is that often many different petroleum products are present at a particular site. The actual contaminant may represent a combination of POL products. In addition, the contaminant will have weathered from long-term exposure at the site. Many other quantifying analytical methods also encounter this problem.

7.4.2 To prepare the standards, a soil sample is collected from the specific site to be characterized. The soil is gathered from below the surface at a depth of 1-2 feet, to reduce hydrocarbon contamination from aerosols and other airborne particulates. A set of standards is prepared by inoculating the soil samples with a series of increasing amounts of the target analyte. Added concentrations may range from 0 ppm to 50,000 ppm. The spiked samples are tumbled for 24-48 hours to ensure uniform distribution of the fuel.

## **8.0 SAMPLE COLLECTION**

This is an *in situ* method. Spectroscopic measurements are obtained directly without physical sampling. Sample collection is not a part of the normal method procedure.

## **9.0 QUALITY CONTROL**

9.1 Three replicate measurements of a check standard (quinine sulfate) and method blank (clean sand) are taken before and after each set of calibration runs and before and after each penetrometer push. Normal variation of the check standard intensity is 5 percent for one set of replicates. The check standard data may vary up to 20 percent over sets of replicates obtained during multiple pushes. The method blank may vary up to 25 percent for multiple pushes. If variations fall outside of these specified ranges, the probe window and sample cuvette should be cleaned and the measurements of the QA standards repeated. If compliance cannot be achieved, the system operator should begin troubleshooting procedures as per the system's maintenance manual.

## **10.0 CALIBRATION AND STANDARDIZATION**

10.1 At present, there is no standard procedure for calibrating the LIF sensor. Depending on data objectives, fluorescence intensity alone may be reported as a relative indicator of POL presence.

10.2 When called for, a calibration curve is generated to establish the LIF sensor response, dynamic range, and limit of detection. Three replicate measurements of each of the prepared calibration standards are run at the beginning of each day and again the equipment is changed. The calibration standards (most typically diesel fuel marine) may vary up to 20 percent for one data point with a given probe and set of test conditions. If a point falls outside of these specified ranges, the probe window and sample cuvette should be cleaned and the test of the standards repeated. If compliance cannot be achieved, the operator should begin troubleshooting procedures as per the system's maintenance manual and the standards reevaluated until compliance is met.

10.3 If simultaneous geotechnical measurements are to be obtained, the penetrometer strain gauges are calibrated in accordance with ASTM D3441.

## **11.0 PROCEDURE**

11.1 Before the LIF/CPT system is deployed, the site is visited to determine location of obstructions that would limit access by the CPT truck. These obstructions may include buildings, cement platforms, and fence lines. The site is also surveyed for possible underground obstructions such as utilities, pipelines, and existing storage tanks. At this time,

information on possible contaminants and prior efforts at characterization or remediation is also obtained. Soil samples can be collected to prepare of calibration standards.

11.2 The truck is deployed with a four-person field crew, including a professional geologist. Two people are needed handle the push rods and operate the hydraulic press. A third person operates the LIF sensor, taking measurements of the calibration and control standards, and monitoring the actual real-time push data. The truck is positioned over the location to be pushed and then elevated and leveled on hydraulic jacks. Following a short series of measurements to establish quality control, the sensor is pushed into the ground at a rate of 1 meter/minute. The push rods are 1 meter in length, and rods are added approximately once a minute as the sensor is advanced. A 30-meter push will typically require about 40 minutes to reach full depth. Generally, the hole will be grouted with a cement mixture as the probe is removed, through a tube connected through the probe to an expendable probe tip. Five to six pushes a day, or approximately 200 feet, can be accomplished in a routine day's operation.

11.3 The fluorescence spectra from the spiked samples are measured at the start of each day of field operations. As with the check standard, 20 shots are averaged to provide a single measurement. At present, a single aliquot from each standard concentration is measured three times, with the aliquot being stirred between measurements. The standard deviation of the calibration standards will reflect both the internal noise as well as the variations due to inhomogeneities in the soil, and can be compared to that of the check standard (quinine sulfate) to assess the inhomogeneity of the soil at the site.

## 12.0 DATA ANALYSIS AND CALCULATIONS

12.1 When using a calibration curve for analysis, the fluorescence intensity for each calibration sample is regressed to establish a slope and intercept. For each regression, a record of the goodness of the fit ( $r^2$ ) and the uncertainty in the slope and intercept values are calculated:

$$I = \alpha C + I_0$$

where I is the measured fluorescence intensity in counts, C is the concentration of the target analyte in mg/kg,  $I_0$  is the intercept in fluorescent counts,  $\alpha$  is the slope, and

$$\Delta I_0 = \text{uncertainty in intercept}$$

$$\Delta \alpha = \text{uncertainty in slope}$$

determined from the goodness of the fit.

This regression shall be carried out using only the lower concentration calibration standards. Log-log plots shall be used for analysis of the complete set. The fluorescence threshold and the detection limit shall be determined as follows:

$$\text{threshold limit} = I_0 + \Delta I_0$$

$$\text{detection limit} = \Delta I_0 / \alpha$$

The fluorescence threshold limit is that number of fluorescent counts above which will be considered a detect, below which will be considered nondetect for the test.

### **13.0 METHOD PERFORMANCE**

13.1 The detection limit, accuracy, and precision obtained through use of this method are highly dependent on the soil matrix, target analyte, and choice of laser wavelength.

### **14.0 POLLUTION PREVENTION**

The reference analytical methods require that discrete soil samples be obtained from the subsurface using a hand or power auger, drill rig, or soil trenching equipment. These methods generate waste contaminated soils that must be treated or landfilled. The SCAPS CPT does not generate any waste soils. The reference methods require that soil samples be submitted to the laboratory for extraction and analysis. In order to achieve this, the samples must be kept chilled, usually with ice, in an insulated cooler. Each sample is kept in the cooler in an individual container. The sample containers come in cardboard boxes that must be transported to the site and then either be discarded or recycled. Once the necessary aliquot of soil has been removed from the containers by the laboratory in order to perform the reference methods, the containers and remaining soil must be either stored under refrigeration, disposed of, or decontaminated for reuse. The SCAPS CPT does not require the acquisition of soil samples in jars or tubes, or any refrigerated storage.

The SCAPS CPT generates wastewater in steam cleaning the rods and probe after each push. The amount of wastewater generated is small in comparison to the amount necessary to decontaminate a similar footage of augers and samplers necessary in order to obtain soil samples for the reference method.

Since the crew are isolated from all but the surface chemical hazards at the site, the amount of personal protective equipment (PPE) typically used is minimal. Drilling or trenching, on the other hand, could expose personnel to the subsurface contaminants they are trying to assess. As a consequence, the drilling or trenching necessary to obtain soil samples for the reference method will result in the use of a greater amount of PPE, which must then be either decontaminated (creating more wastewater) for reuse or discarded at an appropriate landfill depending on the degree to which it is contaminated.

### **15.0 WASTE MANAGEMENT**

The wastewater generated by the steam cleaning system is vacuumed into and stored in 55-gallon drums in a designated area of the site being characterized. Each drum is labeled with the site name, date, contents, and corresponding pushes during which the wastewater was generated. After operations at the site are complete, an appropriate subgroup of the drums (usually representing the anticipated worst case) is randomly selected for sampling. Based on the results of the analysis of the wastewater samples, an appropriate disposal method is selected. This method is often discharge to the sewer following review of the analyses results by the publicly owned treatment works (POTW).

### **16.0 REFERENCES**

References are to be provided by NCCOSC RDT&E Division.

## 17.0 SYSTEM SCHEMATIC

A schematic of the SCAPS LIF system is provided.

