

# FINAL REPORT

Field Demonstration of Propane  
Biosparging for *In Situ* Remediation  
of N-Nitrosodimethylamine (NDMA) in Groundwater

ESTCP Project ER-200828

DECEMBER 2015

Paul B. Hatzinger, Ph.D.  
David Lippincott, P.G.  
CB&I Federal Services, LLC.



*Page Intentionally Left Blank*

This report was prepared under contract to the Department of Defense Environmental Security Technology Certification Program (ESTCP). The publication of this report does not indicate endorsement by the Department of Defense, nor should the contents be construed as reflecting the official policy or position of the Department of Defense. Reference herein to any specific commercial product, process, or service by trade name, trademark, manufacturer, or otherwise, does not necessarily constitute or imply its endorsement, recommendation, or favoring by the Department of Defense.

*Page Intentionally Left Blank*

| REPORT DOCUMENTATION PAGE  |                  |                         | Form Approved<br>OMB No. 0704-0188             |  |   |
|--|------------------|-------------------------|--|--|---|
| <p>The public reporting burden for this collection of information is estimated to average 1 hour per response, including the time for reviewing instructions, searching existing data sources, gathering and maintaining the data needed, and completing and reviewing the collection of information. Send comments regarding this burden estimate or any other aspect of this collection of information, including suggestions for reducing the burden, to the Department of Defense, Executive Services and Communications Directorate (0704-0188). Respondents should be aware that notwithstanding any other provision of law, no person shall be subject to any penalty for failing to comply with a collection of information if it does not display a currently valid OMB control number.</p> <p><b>PLEASE DO NOT RETURN YOUR FORM TO THE ABOVE ORGANIZATION.</b></p>   |                  |                         |  |  |   |
| 1. REPORT DATE (DD-MM-YYYY)<br>12-30-2015  |                  | 2. REPORT TYPE<br>Final |  | 3. DATES COVERED (From - To)<br>May 2008 - December 2015 |   |
| 4. TITLE AND SUBTITLE<br>Field Demonstration of Propane Biosparging for In Situ Treatment of N-nitrosodimethylamine (NDMA) in Groundwater  |                  |                         | 5a. CONTRACT NUMBER<br>W912-HQ-08-C-0015       |  |   |
|  |                  |                         | 5b. GRANT NUMBER<br>NA                         |  |   |
|  |                  |                         | 5c. PROGRAM ELEMENT NUMBER<br>NA               |  |   |
| 6. AUTHOR(S)<br>Hatzinger, Paul B., Ph.D.<br>Lippincott, David, P.G.   |                  |                         | 5d. PROJECT NUMBER<br>ER-200828                |  |   |
|  |                  |                         | 5e. TASK NUMBER<br>NA                          |  |   |
|  |                  |                         | 5f. WORK UNIT NUMBER<br>NA                     |  |   |
| 7. PERFORMING ORGANIZATION NAME(S) AND ADDRESS(ES)<br>CB&I Federal Services, LLC.<br>17 Princess Road<br>Lawrenceville, NJ 08648   |                  |                         | 8. PERFORMING ORGANIZATION REPORT NUMBER<br>NA |  |   |
| 9. SPONSORING/MONITORING AGENCY NAME(S) AND ADDRESS(ES)<br>Environmental Security Technology Certification Program<br>4800 Mark Center Drive, Suite 17D08<br>Alexandria, VA 22350-3605   |                  |                         | 10. SPONSOR/MONITOR'S ACRONYM(S)<br>ESTCP      |  |   |
|  |                  |                         | 11. SPONSOR/MONITOR'S REPORT NUMBER(S)<br>NA   |  |   |
| 12. DISTRIBUTION/AVAILABILITY STATEMENT<br>Distribution Statement A: Approved for Public Release, Distribution is Unlimited  |                  |                         |  |  |   |
| 13. SUPPLEMENTARY NOTES<br>None  |                  |                         |  |  |   |
| 14. ABSTRACT<br>This ESTCP demonstration evaluated the technical effectiveness and cost of in situ propane biosparging for treating N-nitrosodimethylamine (NDMA) in groundwater. The demonstration site was the Aerojet Superfund Site in Rancho Cordova, CA. The propane sparging system, which consisted of three biosparging wells connected to an air compressor and propane gas feed, supplied approximately 1.8 lbs of propane to the in situ test plot per day to stimulate native bacteria to biodegrade NDMA. Over the 374 day operational period of the system, NDMA concentrations were reduced by > 99.7% in the treatment area, declining from as high as 25,000 ng/L to < 3 ng/L in one system monitoring well. Over the same time period, NDMA concentrations in a sidegradient control well declined by only 14%. There were no negative impacts to groundwater geochemistry. A full-scale biosparging system was determined to be approximately 40% less expensive to build, install, and operate than a comparable ultraviolet system over a 30 year remedial time frame. |                  |                         |  |  |   |
| 15. SUBJECT TERMS<br>bioremediation, biodegradation, biosparging, N-nitrosodimethylamine, NDMA, propane, propanotroph, cometabolic, groundwater  |                  |                         |  |  |   |
| 16. SECURITY CLASSIFICATION OF:  |                  |                         | 17. LIMITATION OF ABSTRACT<br>UU               | 18. NUMBER OF PAGES                                      | 19a. NAME OF RESPONSIBLE PERSON<br>Dr. Paul B. Hatzinger  |
| a. REPORT<br>U   | b. ABSTRACT<br>U | c. THIS PAGE<br>U       |  |  | 19b. TELEPHONE NUMBER (Include area code)<br>609-895-5356 |

Reset

Standard Form 298 (Rev. 8/98)  
Prescribed by ANSI Std. Z39.18

*Page Intentionally Left Blank*

## Table of Contents

|  |             |
|--|-------------|
| <b>List of Figures</b> .....   | <b>vi</b>   |
| <b>List of Tables</b> .....  | <b>viii</b> |
| <b>List of Appendices</b> .....  | <b>viii</b> |
| <b>List of Acronyms and Abbreviations</b> .....                                    | <b>ix</b>   |
| <b>Acknowledgements</b> .....  | <b>xii</b>  |
| <b>Executive Summary</b> .....   | <b>xiii</b> |
| <b>1.0 INTRODUCTION</b> .....  | <b>1</b>    |
| 1.1 BACKGROUND .....   | 1           |
| 1.2 OBJECTIVE OF THE DEMONSTRATION .....   | 1           |
| 1.3 REGULATORY DRIVERS .....   | 1           |
| <b>2.0 TECHNOLOGY</b> .....  | <b>3</b>    |
| 2.1 TECHNOLOGY DESCRIPTION .....   | 3           |
| 2.2 TECHNOLOGY DEVELOPMENT .....   | 4           |
| 2.3 ADVANTAGES AND LIMITATIONS OF THE TECHNOLOGY .....                             | 9           |
| <b>3.0 PERFORMANCE OBJECTIVES</b> .....  | <b>11</b>   |
| 3.1 DETERMINE EFFECTIVENESS OF NDMA TREATMENT .....                                | 12          |
| 3.1.1 Data Requirements for NDMA Treatment Effectiveness .....                     | 12          |
| 3.1.2 Success Criteria for NDMA Treatment Effectiveness .....                      | 12          |
| 3.2 ADEQUATE DISTRIBUTION OF GASES IN GROUNDWATER.....                             | 14          |
| 3.2.1 Data Requirements for Gas Distribution.....                                  | 15          |
| 3.2.2 Success Criteria for Gas Distribution.....                                   | 15          |
| 3.3 MINIMAL NEGATIVE IMPACTS TO GROUNDWATER GEOCHEMISTRY .....                     | 16          |
| 3.3.1 Data Requirements for Geochemical Changes .....                              | 16          |
| 3.3.2 Success Criteria for Geochemical Changes .....                               | 16          |
| 3.4 INCREASE IN PROPANOTROPH POPULATION .....                                      | 17          |
| 3.4.1 Data Requirements for Propanotroph Population .....                          | 17          |
| 3.4.2 Success Criteria for Propanotroph Population .....                           | 17          |
| 3.5 SYSTEM RELIABILITY .....   | 17          |
| 3.5.1 Data Requirements for System Reliability.....                                | 18          |
| 3.5.2 Success Criteria for System Reliability.....                                 | 18          |
| <b>4.0 SITE DESCRIPTION</b> .....  | <b>19</b>   |
| 4.1 SITE LOCATION AND HISTORY .....  | 19          |
| 4.2 SITE GEOLOGY/HYDROGEOLOGY .....  | 24          |
| 4.3 CONTAMINANT DISTRIBUTION .....   | 33          |
| <b>5.0 TEST DESIGN</b> .....   | <b>35</b>   |
| 5.1 CONCEPTUAL EXPERIMENTAL DESIGN .....   | 35          |
| 5.2 BASELINE CHARACTERIZATION .....  | 35          |
| 5.2.1 Groundwater Elevation Data Collection .....                                  | 36          |
| 5.2.2 Groundwater Sampling of Existing Monitoring Wells .....                      | 37          |
| 5.2.3 Slug Testing at Existing Monitoring Wells near GET A Pond.....               | 38          |
| 5.2.4 Continuous Soil Core Collection .....  | 38          |
| 5.2.5 Discrete Groundwater Sample Collection and Selection of Treatment Depth..... | 39          |
| 5.2.6 Monitoring and Biosparging Well Installations .....                          | 41          |
| 5.2.7 Groundwater Sampling of Monitoring and Biosparging Wells .....               | 42          |
| 5.2.8 Sparge Testing.....  | 44          |
| 5.2.9 Bromide Tracer Testing.....  | 47          |
| 5.2.10 Passive Flux Meter Testing .....  | 48          |
| 5.3 LABORATORY STUDY RESULTS .....   | 49          |
| 5.3.1 Groundwater Sample Collection .....  | 49          |

|            |   |            |
|------------|---|------------|
| 5.3.2      | Collection of Aquifer Solids .....                            | 49         |
| 5.3.3      | Batch and Microcosm Studies.....                              | 50         |
| 5.3.4      | Mesocosm Studies.....   | 51         |
| 5.3.5      | Column Studies.....   | 52         |
| 5.3.6      | Conclusions from Laboratory Studies.....                      | 60         |
| 5.4        | DESIGN AND LAYOUT OF TECHNOLOGY COMPONENTS.....               | 61         |
| 5.4.1      | Demonstration Plot Layout .....                               | 61         |
| 5.4.2      | Monitoring and Biosparging Well Installation .....            | 62         |
| 5.4.3      | Biosparging System Design.....                                | 66         |
| 5.4.3.1    | Biosparge Trailer #1.....                                     | 68         |
| 5.4.3.2    | Biosparge Trailer #2.....                                     | 68         |
| 5.4.4      | Biosparging System Installation and Testing.....              | 70         |
| 5.5        | FIELD TESTING.....  | 71         |
| 5.5.1      | System Start-Up and Monitoring .....                          | 71         |
| 5.5.2      | System Operation & Performance Monitoring .....               | 72         |
| 5.5.3      | System Shutdown and Demobilization .....                      | 73         |
| 5.6        | SAMPLING METHODS.....   | 76         |
| 5.6.1      | Groundwater Sampling and Analysis.....                        | 76         |
| 5.6.2      | Numbers and Types of Samples Collected .....                  | 77         |
| 5.6.3      | Quality Assurance for Groundwater Sampling and Analysis ..... | 79         |
| 5.7        | SAMPLING RESULTS.....   | 85         |
| 5.7.1      | NDMA .....  | 85         |
| 5.7.2      | Volatile Organic Compounds (VOCs) .....                       | 87         |
| 5.7.3      | Dissolved Gases .....   | 87         |
| 5.7.3.1    | Propane.....  | 87         |
| 5.7.3.2    | Dissolved oxygen.....   | 89         |
| 5.7.3.3    | Dissolved methane.....  | 89         |
| 5.7.4      | Oxidation-Reduction Potential (ORP).....                      | 89         |
| 5.7.5      | Anions .....  | 89         |
| 5.7.6      | pH.....   | 90         |
| 5.7.7      | Temperature.....  | 90         |
| 5.7.8      | Total propanotrophs .....                                     | 94         |
| <b>6.0</b> | <b>PERFORMANCE ASSESSMENT.....</b>                            | <b>95</b>  |
| 6.1        | EFFECTIVENESS OF NDMA TREATMENT .....                         | 95         |
| 6.2        | ADEQUATE DISTRIBUTION OF GASES IN GROUNDWATER.....            | 96         |
| 6.3        | MINIMAL NEGATIVE IMPACTS TO GROUNDWATER GEOCHEMISTRY .....    | 97         |
| 6.4        | INCREASE IN PROPANOTROPH POPULATION .....                     | 98         |
| 6.5        | SYSTEM RELIABILITY .....                                      | 98         |
| <b>7.0</b> | <b>COST ASSESSMENT .....</b>                                  | <b>100</b> |
| 7.1        | COST MODEL .....  | 100        |
| 7.1.1      | Capital Costs.....  | 102        |
| 7.1.2      | O&M Costs.....  | 102        |
| 7.1.3      | Demonstration-Specific Costs .....                            | 102        |
| 7.2        | COST DRIVERS .....  | 102        |
| 7.2.1      | General Considerations.....                                   | 102        |
| 7.2.2      | Competing Treatment Technologies .....                        | 103        |
| 7.3        | COST ANALYSIS.....  | 103        |
| 7.3.1      | Base Case.....  | 103        |
| 7.3.2      | Propane Biosparge Barrier .....                               | 106        |
| 7.3.3      | Pump and Treat with UV Treatment.....                         | 107        |
| 7.3.4      | Pump and Treat with FBR Treatment .....                       | 108        |



|            |  |            |
|------------|--|------------|
| <b>8.0</b> | <b>IMPLEMENTATION ISSUES.....</b>  | <b>110</b> |
| 8.1        | END-USER ISSUES .....  | 110        |
| 8.1.1      | Technology Applicability and Performance under Local Site Conditions ..... | 110        |
| 8.1.2      | Safety .....   | 111        |
| 8.1.3      | Secondary Impacts to the Local Aquifer .....                               | 111        |
| 8.1.4      | Technology Cost Compared to Other Remedial Options .....                   | 112        |
| <b>9.0</b> | <b>REFERENCES.....</b>   | <b>113</b> |

## List of Figures

- Figure 2-1. Basic layout of the air and propane biosparging system.
- Figure 2-2. Metabolites produced during the oxidation of NDMA by *R. ruber* ENV425 after growth on propane.
- Figure 2-3. Biodegradation of NDMA by the propanotroph *Rhodococcus ruber* ENV425 in batch culture.
- Figure 2-4. Percent mineralization of  $^{14}\text{C}$ -NDMA to  $^{14}\text{CO}_2$  in microcosms prepared with aquifer solids and groundwater from three different states (NJ, CO, CA).
- Figure 2-5. Effect of propane on the mineralization of  $^{14}\text{C}$ -NDMA to  $^{14}\text{CO}_2$  by the propanotroph *Rhodococcus ruber* ENV425.
- Figure 2-6. Laboratory propane-fed membrane bioreactor treating NDMA. Influent and effluent data from the MBR.
- Figure 2-7. Biodegradation of NDMA and TCE by indigenous bacteria in aquifer samples from New Jersey.
- Figure 3-1. Layout of final biosparging test plot.
- Figure 3-2. Initial wells installed for gas distribution testing.
- Figure 4-1. Location map.
- Figure 4-2. Proposed demonstration location.
- Figure 4-3. Locations of site investigation work conducted to determine the best demonstration location for the Test Plot Area.
- Figure 4-4. Geomorphic provinces of California and location of Aerojet Site.
- Figure 4-5. Aerojet facility geologic cross section.
- Figure 4-6. Eastern Operable Unit conceptual hydrogeologic model.
- Figure 4-7. Zone 4 hydrostratigraphic cross section H-H'.
- Figure 4-8. Groundwater elevations in the Mehrten formation, third water bearing layer (M4), Fall 2004, Eastern Operable Unit.
- Figure 4-9. Zone 4 Total VOCs and NDMA in the Mehrten formation fourth water bearing layer (M4).
- Figure 5-1. Groundwater mounding measurements in PMW-1 to PMW-4 during air sparge testing at BSW-1.
- Figure 5-2. Dissolved oxygen in PMW-1, PMW-2, and PMW-3 during air sparge testing at BSW-1.
- Figure 5-3. Bromide concentrations in PMW-2, PMW-3 (used as injection well), and PMW-4 during 14-day tracer study.
- Figure 5-4. Darcy velocity in PMW-2, PMW-3, and PMW-4 based on passive flux meter testing.
- Figure 5-5. Mineralization of  $^{14}\text{C}$ -NDMA to  $^{14}\text{CO}_2$  in Aerojet microcosms pre-incubated with propane, propane + nutrients (+/- ENV425), methane, or oxygen.
- Figure 5-6. Flow-through model aquifer columns used to evaluate NDMA biodegradation in site materials.

- Figure 5-7. NDMA concentrations in influent and effluent water from Column 3 (C3: oxygen only).
- Figure 5-8. NDMA concentrations in influent and effluent water from Column 4 (C4: propane, oxygen, formaldehyde).
- Figure 5-9. NDMA concentrations in influent and effluent water from Column 2 (C2: propane, oxygen).
- Figure 5-10. NDMA concentrations in influent and effluent water from Column 1 (C1: propane, oxygen, YE, nutrients).
- Figure 5-11. TCE and Freon-113 concentrations in influent and effluent water from Column 2 (C2: propane, oxygen).
- Figure 5-12. Propane concentrations in influent and effluent water from Column 2 (C2: propane, oxygen).
- Figure 5-13. DGGE gels from C2 and C3 and microbial identifications of each band via 16S rDNA analysis.
- Figure 5-14. NDMA concentrations in samples from Picatinny Arsenal, NJ in the presence of absence of TCE (2 mg/L).
- Figure 5-15. Original layout of demonstration plot biosparge and monitoring wells.
- Figure 5-16. Final layout of demonstration plot biosparge and monitoring wells.
- Figure 5-17. P&ID of propane injection trailers.
- Figure 5-18. Photograph of biosparge trailer units.
- Figure 5-19. Inside of Trailer #1 which houses the controls and air supply system.
- Figure 5-20. Inside of Trailer # 2, which houses the propane feed and distribution as well as SVE equipment.
- Figure 5-21. System check form used to document system settings and pressures.
- Figure 5-22. Example groundwater parameter stabilization form.
- Figure 5-23. Chain of Custody (COC) form used by CB&I's laboratory.
- Figure 5-24. Concentrations of NDMA in the demonstration plot.
- Figure 5-25. Concentrations of propane in the demonstration plot.
- Figure 5-26. Concentrations of propane in PMW-3 and PMW-4 during a propane biosparge test.
- Figure 5-27. Concentrations of dissolved oxygen in the demonstration plot wells.
- Figure 5-28. Oxidation-reduction potential (ORP) in the demonstration plot wells.
- Figure 5-29. Concentration of nitrate-N in the demonstration plot wells.
- Figure 5-30. Concentration of sulfate in the demonstration plot wells.
- Figure 5-31. pH of groundwater in the demonstration plot wells.
- Figure 5-32. Temperature of groundwater in the demonstration plot wells.
- Figure 5-33. Total propanotrophs in groundwater in the demonstration plot wells.
- Figure 7-1. Base case plume characteristics.

## **List of Tables**

Table 3-1. Performance Objectives.

Table 4-1. General Site Stratigraphy.

Table 5-1. Geochemical and Contaminant Data from Wells 312, 331, and 3262.

Table 5-2. Geochemical and Contaminant Data from Soil Borings in the Get A Pond Area (DB-1) and the Alder Creek Area near EW 4125 (DB-3).

Table 5-3. Geochemical and Contaminant Data from Wells Installed in the Get A Pond Area (DBMW-1) and the Alder Creek Area near EW 4125 (BSW-1, PMW1-4).

Table 5-4. Operational Conditions for the Flow-Through Aquifer Columns.

Table 5-5. Summary of As-Built Well Construction Details.

Table 5-6. Timeline of Sampling and System Operation.

Table 5-7. Analytical Methods for the Demonstration.

Table 5-8. Total Number and Types of Samples Collected During the Demonstration.

Table 7-1. Demonstration Cost Components.

Table 7-2. Summary of Base Case Site Characteristics and Design Parameters.

Table 7-3. Cost Components for Biosparging.

Table 7-4. Cost Components for Pump and Treat with UV Treatment.

Table 7.5. Cost Components for Pump and Treat with FBR Treatment.

Table 7-6. Summary of Capital Costs and NPV of Costs for O&M and Monitoring.

## **List of Appendices**

Appendix A. Points of Contact

Appendix B. Analytical Results

Appendix C. Well Logs and Destruction Reports

## List of Acronyms and Abbreviations

Aerojet—Aerojet Superfund Site, Rancho Cordova, CA  
Amp—amperes  
AS—air sparging  
bgs—below ground surface  
BMW—background monitoring well  
BW—biosparge well  
C—carbon  
C1—column 1  
C2—column 2  
C3—column 3  
C4—column 4  
°C—degrees Celsius  
<sup>14</sup>C—radiolabeled carbon  
CB&I—CB&I Federal Services, LLC  
C<sub>3</sub>H<sub>8</sub>—propane gas  
cm—centimeter(s)  
CO<sub>2</sub>—carbon dioxide  
COC—chain of custody  
DCE—*cis*-1,2-dichloroethylene  
DGGE—denaturing gradient gel electrophoresis  
DMP—2,4-dimethyl-3-pentanol  
DO—dissolved oxygen  
DoD—Department of Defense  
EDB—1,2-dibromoethane  
ELAP—Environmental Laboratory Accreditation Program  
ENV425—propanotroph *Rhodococcus ruber* ENV425  
EPA—Environmental Protection Agency  
ESTCP—Environmental Security Technology Certification Program  
EW —extraction (downgradient pumping) well  
FBR—fluidized bed reactor  
Fe—iron  
FRTR—Federal Remediation Technologies Roundtable  
Freon-113—1,1,2-trichloro-1,2,2-trifluoroethane  
ft—feet/foot  
gal—gallons  
GC—gas chromatography  
GET — Groundwater Extraction and Treatment  
GET A— Groundwater Extraction and Treatment System A at Aerojet  
GPM—gallons per minute  
GWP—global warming potential  
HCl—hydrochloric acid

HDPE—high density polyethylene  
HMX - octahydro-1,3,5,7-tetranitro-1,3,5,7 tetrazocine  
HP—horsepower  
hr—hour(s)  
HRT—hydraulic residence time  
ID—inner diameter  
IPA—*isopropyl alcohol*  
IPR—interim progress report  
K—hydraulic conductivity  
L—liter  
lbs—pounds  
LEL—lower explosive limit  
LP—liquefied petroleum  
LRTA—liquid rocket test area  
MBR—membrane bioreactor  
MCL—maximum contaminant level  
MDL—minimum detection limit  
µg—micrograms  
mg—milligrams  
min—minute(s)  
mL—milliliters  
Mn—manganese  
mol—mole  
mV—millivolts  
MW—monitoring well  
N—nitrogen  
NASA—National Aeronautics and Space Administration  
NDMA—N-nitrosodimethylamine  
ng—nanograms  
NO<sub>3</sub>—nitrate  
NPV—Net Present Value  
O<sub>2</sub>—oxygen gas  
O&M—operations and maintenance  
OEHHA—Office of Environmental Health Hazard Assessment  
OMB—Office of Management and Budget  
ORP—oxidation-reduction potential  
OU—Operable Unit  
P—phosphate  
P&ID—Process and Instrumentation Diagram  
P&T—Pump and Treat  
PCB—polychlorinated biphenyl  
PCD—Partial Consent Decree  
PFM—Passive Flux Meter

PHG—public health goal  
PID—photo-ionization detector  
PLC—Programmable Logic Controller  
PMO—propane monooxygenase  
PMW—performance monitoring well  
PO<sub>4</sub>—phosphate  
POC—point of contact  
PQL—practical quantitation limit  
psi—pounds per square inch  
PTA—pilot test area  
PVC—polyvinyl chloride  
QA—quality assurance  
QC—quality control  
qPCR—quantitative polymerase chain reaction  
RDX—hexahydro-1,3,5-trinitro-1,3,5-triazine  
RI/FS—Remedial Investigation/Feasibility Study  
RPD—Relative Percent Difference  
RWQCB—Regional Water Quality Control Board  
μS—microsiemens  
SCADA—supervisory control and data acquisition  
SCFM—standard cubic feet per minute  
SERDP—Strategic Environmental Research and Development Program  
SF<sub>6</sub>—sulfur hexafluoride  
SO<sub>4</sub>—sulfate  
SU—standard units  
SVE—soil vapor extraction  
SWRCB—State Water Resources Control Board  
TCE—1,1,2-trichloroethene  
TPA—Test Plot Area  
UDMH—unsymmetrical dimethylhydrazine or 1,1- dimethylhydrazine  
USEPA—United States Environmental Protection Agency  
UV—ultraviolet  
VAC—volts alternating current  
VOA—volatile organic analysis  
VOC—volatile organic carbon  
WSTF—NASA White Sands Test Facility  
YE—yeast extract

## **Acknowledgements**

This Environmental Security Technology Certification Program (ESTCP) project was a collaborative effort among scientists and engineers at CB&I Federal Services, LLC (CB&I; Formerly Shaw Environmental, Inc., Lawrenceville, NJ) and the Aerojet Corporation (Aerojet, Rancho Cordova, CA). We wish to thank the Aerojet facility staff and subcontractors supporting the project demonstration. In particular, special thanks to Mr. Scott Neville from Aerojet for his consistent dedication to the project study and its success. We also wish to thank ESTCP for their financial support, and Dr. Andrea Leeson, the Environmental Restoration Program Manager at ESTCP for her guidance. Finally, in large degree, the overall success of the project is a direct function of the personnel that designed and operated the system, and conducted system O&M and groundwater sampling. In particular, Neil Harvey, Paul Weinhardt, and Sheryl Streger of CB&I were vital to project success. Their efforts ultimately lead to the quality experimental results and findings demonstrated during this project.



## Executive Summary

N-Nitrosodimethylamine (NDMA) is present in groundwater and drinking water from industrial, agricultural, water treatment, and military/aerospace sources. NDMA is a suspected human carcinogen and an emerging groundwater contaminant that has been detected at a number of Department of Defense (DoD) and National Aeronautics and Space Administration (NASA) sites involved in the production, testing, and/or disposal of liquid propellants containing unsymmetrical dimethylhydrazine (UDMH). NDMA was a common contaminant in UDMH-containing fuels (e.g., Aerozine-50) and is also produced when these fuels enter the environment through natural oxidation processes. Currently, the most effective treatment technology for NDMA in groundwater is pump-and-treat with ultraviolet irradiation (UV). However, this approach is expensive because it requires high energy input to effectively reduce the levels of NDMA to meet regulatory requirements. The objective of this ESTCP project was to demonstrate and validate the application of *in situ* propane biosparging for treatment of NDMA in groundwater.

This ESTCP project builds upon the successful results from Strategic Environmental Research and Development Program (SERDP) Project ER-1456, the objective of which was to examine the potential for *in situ* and *ex situ* biodegradation of N-nitrosodimethylamine (NDMA) in groundwater. The key findings of that project were as follows: (1) a variety of propane-oxidizing bacteria are capable of degrading NDMA to innocuous products; (2) biodegradation of NDMA from typical groundwater concentrations (e.g., 1-100 µg/L) to low ng/L levels by these organisms is achievable; (3) propanotrophs capable of degrading NDMA are indigenous to many different environments, and these organisms can be stimulated to degrade NDMA through the addition of propane and oxygen; and (4) propane does not appear to be a significant inhibitor of NDMA biodegradation by many propanotrophs even though the reaction is co-metabolic. The results of the SERDP project suggest that an *in situ* approach for NDMA treatment based on propane injection can be successful and widely applicable.

During this *in situ* demonstration, propane gas and oxygen were added to groundwater via sparging to stimulate native propanotrophs to biodegrade NDMA *in situ*. The demonstration was performed at the Aerojet Superfund Site (Aerojet) in Rancho Cordova, CA in a location downgradient of a site where liquid rocket engines were developed and tested, including those used in the Titan and Apollo programs. The groundwater in this area has NDMA concentrations ranging from ~ 2,000 to > 30,000 ng/L. Currently, the groundwater in this region is captured by a groundwater extraction & treatment (GET) system and NDMA is removed by ultraviolet irradiation.

To evaluate effectiveness of biosparging, NDMA concentrations in groundwater were monitored in a series of performance monitoring wells (PMWs) placed within a Test Plot Area (TPA), three of which (PMW-2, PMW-3, PMW-4) were within or slightly downgradient of the expected zone of influence of three biosparge wells (BW-6, BW-7, PMW-1). It should be noted that PMW-1 was used as both a biosparge well and a performance monitoring well throughout the demonstration. Monitoring wells PMW-5 and PMW-6 were downgradient of the plot and expected to be influenced later in the demonstration, as treated water reached this region. Well

BMW-1, which was side-gradient (~ 75 ft west of the center of the biosparge zone) was used as a control well to monitor NDMA concentrations outside of the treatment zone.

The biosparging system was operated for a period of 374 days from start-up to shut-down. Full rounds of groundwater sampling were conducted on 12 occasions. This included two baseline sampling rounds on Day -84 and -70, nine performance sampling events during active sparging (Days 42, 84, 161, 185, 213, 241, 287, 311, and 353) and two rebound events after biosparging ceased (Day 385 and 430). The variables that were adjusted and optimized throughout the demonstration included (1) the percentage of propane in the air-propane feed; (2) the length of sparging cycles; (3) the number of sparging cycles per day; and (4) the breakdown of the sparge cycle, which was composed of an initial air sparge, and period of combined air-propane sparging, and then a final air sparge to clear the sparge lines of propane gas. When the system was optimized, the percent propane in the sparge gas set at 40% of the LEL, (which equated to ~ 0.84% propane in the feed gas) and the system was operated for 12 cycles per day with propane being added for 40 minutes during each cycle. The amount of propane added to the TPA after optimization was ~ 1.83 lbs/day, and a total of approximately 475 lbs of propane was injected throughout the demonstration.

The biosparging approach was highly effective for the removal of NDMA from the aquifer. From baseline sampling (average concentrations from Day -70 and Day -84) to the final day of sampling during active biosparging (Day 353), concentrations of NDMA declined by 99.7 % to > 99.9 % in the four PMWs within the zone of influence of the biosparge system (PMW-1 to PMW-4). Baseline concentrations of NDMA, which averaged  $25,000 \pm 6000$  ng/L (7 test plot monitoring wells, two baseline events) declined to between 2.7 and 72 ng/L by Day 353 (mean value  $40 \pm 30$  ng/L). The NDMA concentration at well PMW-2 was below 3 ng/L on Day 353. By comparison, the NDMA concentration in the side-gradient control well (BMW-1) averaged 36,000 ng/L during baseline sampling and was 31,000 ng/L on Day 353, a decline of only 14 %. Concentrations of NDMA in the far downgradient wells PMW-5 and PMW-6 began to show measurable declines near the end of the demonstration, presumably as treated water from the biosparge plot began to reach this region of the aquifer. NDMA in PMW-5 declined to 5,400 ng/L on Day 430 (from an initial average of 26,000 ng/L) and NDMA in PMW-6 fell to 13,000 ng/L on Day 430 (from an initial average of 22,500 ng/L).

The rate of NDMA biodegradation in the TPA was calculated in wells PMW-2, PMW-3 and PMW-4. First-order rate constants were determined using data from Day 84 to Day 353. The degradation rates were  $0.019 \text{ day}^{-1}$  for PMW-3 ( $R^2 = 0.95$ ),  $0.031 \text{ day}^{-1}$  for PMW-4 ( $R^2 = 0.82$ ) and  $0.037 \text{ day}^{-1}$  for PMW-2 ( $R^2 = 0.68$ ). These rates equate to NDMA half-lives ranging from 19 to 36 days.

A desired minimum ratio of 4 parts oxygen to 1 part propane (mg/L basis) was achieved in the TPA based on the analytical data generated during the project, with DO typically exceeding 10 mg/L during system operation and dissolved propane never exceeding 1 mg/L. During a sparging field test conducted under optimized conditions, two sparge-cycles were performed at 6 SCFM with propane at 40% of the LEL, and propane was measured in PMW-3 and PMW-4 before, during, and after each of the sparge cycles. Propane concentrations in these wells, which reached ~ 225  $\mu\text{g/L}$ , declined to 25 - 50  $\mu\text{g/L}$  during ~ 1 hr, indicating rapid consumption of

propane in the aquifer. If one assumes that the decline in concentration is due predominantly to biodegradation, the propane first order decay rates in these wells were  $0.032 \text{ min}^{-1}$  ( $R^2 = 0.84$ ) for PMW-3 and  $0.021 \text{ min}^{-1}$  ( $R^2 = 0.94$ ) for PMW-4.

The expected cost drivers for installation and operation of a full-scale propane biosparging delivery system for the remediation of NDMA-contaminated groundwater, and those that will determine the cost/selection of this technology over other options include the following:

- Depth of the plume below ground surface;
- Width, length, and thickness of the plume;
- Aquifer lithology and the presence or absence of impervious layers that would impede sparging;
- Regulatory/acceptance of alternatives to sparging that include groundwater extraction and re-injection;
- Length of time for clean-up (e.g., necessity for accelerated clean-up);
- The presence of indigenous propanotrophic bacteria capable of degrading NDMA;
- Presence of co-contaminants such as chloroform, chlorinated ethenes, and chlorinated ethanes;
- The radius of influence that can be achieved via sparging; and
- O&M costs.

Based on a cost analysis for treatment of a shallow groundwater plume (~ 10 – 40 ft bgs) of ~ 400 ft in width, a propane biosparge barrier was determined to be the most cost effective option compared to current alternatives, which included pump-and-treat with either ultraviolet (UV) or biological (via fluidized bed bioreactor) removal of NDMA. Under this scenario, and assuming a 30 year operational period with equivalent costs for groundwater monitoring, the *in situ* barrier approach was more than 40% less expensive than either of the *ex situ* alternatives. The primary cost difference between the alternatives was the high capital cost of building an *ex situ* water conveyance and treatment facility, which is required for the UV or FBR system, but not for the *in situ* biosparge barrier. The capital costs for the *ex situ* options were ~ 3 times those for the *in situ* biobarrier.

In summary, the data from this ESTCP field test clearly indicate that propane biosparging can be an effective approach to reduce the concentrations of NDMA in a groundwater aquifer by 3 to 4 orders of magnitude, and that concentrations in the low ng/L range can be achieved with continuous treatment. These results are consistent with data achieved in pure culture studies as well as with various bioreactor tests. Moreover, for many applications, a propane biosparging system is expected to be significantly less expensive to install and operate than a conventional pump-and-treat system for NDMA removal from groundwater.

## 1.0 INTRODUCTION

### 1.1 BACKGROUND

The origin of NDMA in groundwater and drinking water includes industrial, water treatment, and military sources. Contamination of military installations, NASA facilities, and aerospace contractors with NDMA has occurred largely from the former use and disposal of liquid rocket propellants containing unsymmetrical dimethylhydrazine (UDMH). This compound, which is a major component of the propellant Aerozine-50, contains NDMA as a chemical impurity and has also been observed to oxidize to NDMA in natural environments (Fleming et al., 1996; Mitch et al., 2003). Military and NASA sites reporting NDMA in groundwater include the Rocky Mountain Arsenal (CO); former Air Force Site PJKS (CO); White Sands Missile Range (NM); Aerojet (multiple locations in CA); Jet Propulsion Labs (CA) and Edwards Air Force Base (CA). Testing conducted during the past decade has also revealed that NDMA is present in reclaimed wastewater and in numerous drinking water supplies as a disinfection byproduct (Mitch and Sedlak, 2002a,b; Mitch et al., 2003; Sedlak et al., 2005). Both Los Angeles and Orange Counties in California have reported NDMA in groundwater supply wells (SWRCB, 2015a).

The most effective treatment technology currently available for removing NDMA from groundwater to required levels is *ex situ* treatment with ultraviolet irradiation (UV) which breaks the N-N bond, yielding nitrite and dimethylamine as primary products (Mitch et al., 2003). Although effective, this *ex situ* approach is expensive because the energy required to reduce aqueous NDMA concentrations by one order of magnitude is approximately ten times that used for standard disinfection of viruses and other water-borne pathogens (Mitch et al., 2003), and large-scale pump and treat systems are generally required to contain NDMA plumes derived from rocket testing activities.

### 1.2 OBJECTIVE OF THE DEMONSTRATION

The objective of this ESTCP project was to demonstrate and validate the application of propane and oxygen biosparging for the *in situ* treatment of NDMA-contaminated groundwater to ng/L concentrations. These amendments were added to stimulate the growth of native propanotrophs, a class of microorganisms that rapidly degrade NDMA to innocuous products. This approach, which was based on the results from SERDP Project ER-1456 “Bioremediation Approaches for Treating Low Concentrations of N-Nitrosodimethylamine in Groundwater,” utilized indigenous propane-oxidizing bacteria to biodegrade NDMA in groundwater (Hatzinger et al., 2008; Fournier et al., 2009). To our knowledge, this represents the first *in situ* technology to accelerate aerobic NDMA bioremediation in groundwater. The feasibility and cost of *in situ* treatment of NDMA to ng/L levels was evaluated.

### 1.3 REGULATORY DRIVERS

Historically, NDMA was not thought to be a significant groundwater contaminant, so no federal MCL currently exists for drinking water in the U.S. However, according to EPA, a safe level of NDMA in drinking water based on lifetime *de minimis* risk calculations ( $< 10^{-6}$  risk of developing cancer) is only 0.7 ng/L (USEPA, 2011a), which is below the current practical

quantitation limit for the compound. Due to the carcinogenicity of NDMA, the California Office of Environmental Health Hazard Assessment (OEHHA) established a public health goal (PHG) for NDMA in drinking water of 3 ng/L (OEHHA, 2006). This is lower than the State of California's current *notification level* for NDMA in groundwater, which is 10 ng/L (SWRCB, 2015b). Only three other compounds (of 30 with regulatory notification levels in California) are regulated at or below 10 ng/L (SWRCB, 2015b). Massachusetts also has an action level of 10 ng/L for NDMA in drinking water (MADEP, 2015). The EPA also recently added NDMA to its current Contaminant Candidate List - 3 (CCL-3; USEPA, 2008), which is a possible step toward regulation under the Safe Drinking Water Act. At many military bases and installations, local government water agencies set the pump-and-treat discharge limits of NDMA. For example, NASA White Sands Test Facility (WSTF) in New Mexico has a discharge permit limit of 4.2 ng/L from their pump-and-treat system. The regulatory level for the Aerojet Superfund Site, the location of this demonstration, is only 0.7 ng/L (USEPA, 2008). As the presence of NDMA in ground water aquifers continues to be discovered and potentially impacts drinking water sources, future State and Federal regulations will likely be enhanced further.

## 2.0 TECHNOLOGY

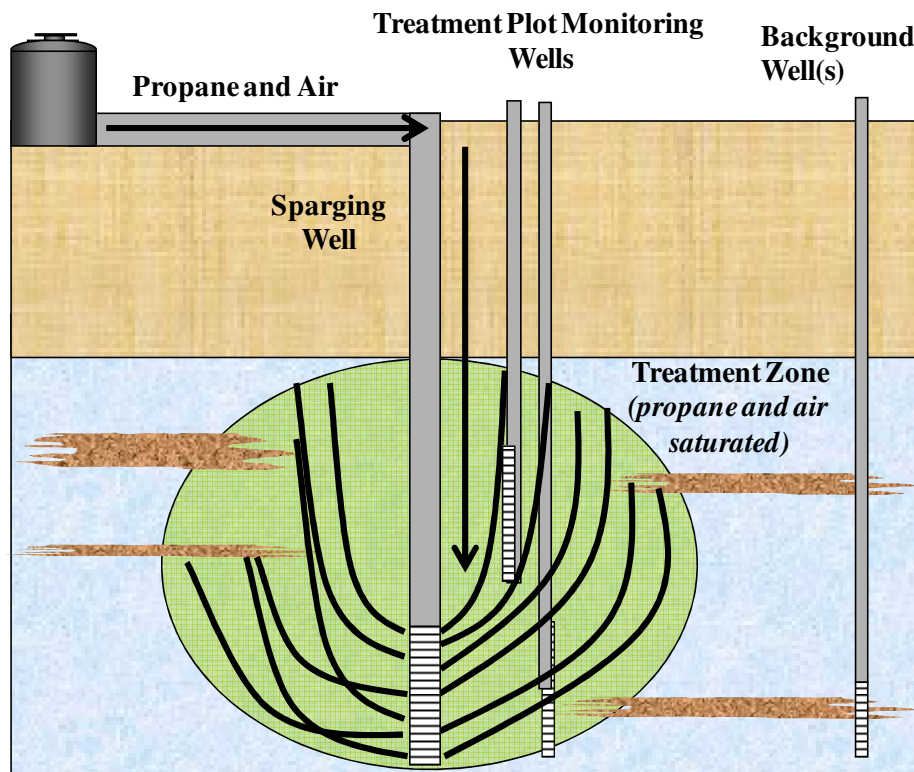
### 2.1 TECHNOLOGY DESCRIPTION

Achieving clean-up levels for NDMA and other water-soluble organic pollutants to low ng/L concentrations is a difficult technological challenge that has not received extensive study. Presently, the most effective technology for removing NDMA from water is ultraviolet irradiation (UV). However, this *ex situ* technology is expensive, requiring the installation of Pump and Treat (P&T) infrastructure, and banks of UV lights that require significant energy to reduce NDMA to required levels. The energy input to reduce NDMA concentrations by one order of magnitude is approximately ten times that necessary for standard disinfection of viruses and other water-borne pathogens (Mitch et al., 2003). In instances where UDMH was released to groundwater, NDMA levels exceeding 300 µg/L have been documented and levels > 5 µg/L are common. The capital cost for installation of P&T infrastructure and a UV system combined with the energy costs for treatment of large volumes of groundwater are anticipated to be prohibitively expensive at some DoD facilities. The objective of this project was to demonstrate an effective, *in situ* biological remediation option for the treatment of NDMA. The technology chosen, cometabolic biosparging, relies on the use of an inexpensive alkane substrate, propane, and oxygen to stimulate the growth and degradative activity of native bacteria. The native NDMA-degrading bacteria are able to use propane as a growth substrate while degrading NDMA (Sharp et al., 2005, 2007; Hatzinger et al., 2008; Fournier et al., 2009), thereby allowing them to grow in an aquifer even as NDMA concentrations are treated to very low levels.

During this ESTCP demonstration, propane and oxygen (from air) were added to an NDMA-contaminated aquifer to stimulate indigenous propanotrophs to biodegrade the nitrosamine from > 200 µg/L to low ng/L concentrations. To our knowledge, this represents the first *in situ* approach for NDMA remediation that is likely to have wide applicability. There are a variety of different ways to supply propane and oxygen to an aquifer, including (1) air- and propane-biosparging, (2) groundwater recirculation with above-ground propane and oxygen addition, (3) bubble-free gas injection systems, and (4) trenches with air and propane injection lines (Steffan et al., 2003). The applicability of these different approaches depends primarily on site geology/hydrogeology and plume characteristics. The key objective was to evenly distribute propane and oxygen gas throughout the desired treatment area in the safest and most cost-effective manner. During this demonstration, we supplied oxygen and propane to a contaminated aquifer using a biosparging approach (see **Figure 2-1**). This approach is mature, cost effective, and can be safely applied in a number of different configurations based on site conditions.

The addition of alkanes, including propane, methane, and butane, has been used in the past to treat contaminants including chlorinated solvents and fuel oxygenates (Battelle, 2001; Semprini and McCarty, 1991; Semprini et al., 1994; Hazen et al., 1994; Steffan et al., 1997, 2003). The main challenges with these earlier applications were the competitive inhibition between the alkane and target substrates, the inability of specialized organisms to compete with native organisms, and the production of toxic metabolites (e.g., TCE epoxide) that can poison the process. However, recent laboratory studies suggest that these factors should not limit NDMA treatment via this approach (Hatzinger et al., 2008; Sharp et al., 2010).

**Figure 2-1. Basic layout of the air and propane biosparging system.** Both propane and oxygen (from air or O<sub>2</sub> gas) were supplied intermittently to groundwater through sparge wells. Concentrations of NDMA, propane, and oxygen were measured in groundwater monitoring wells.

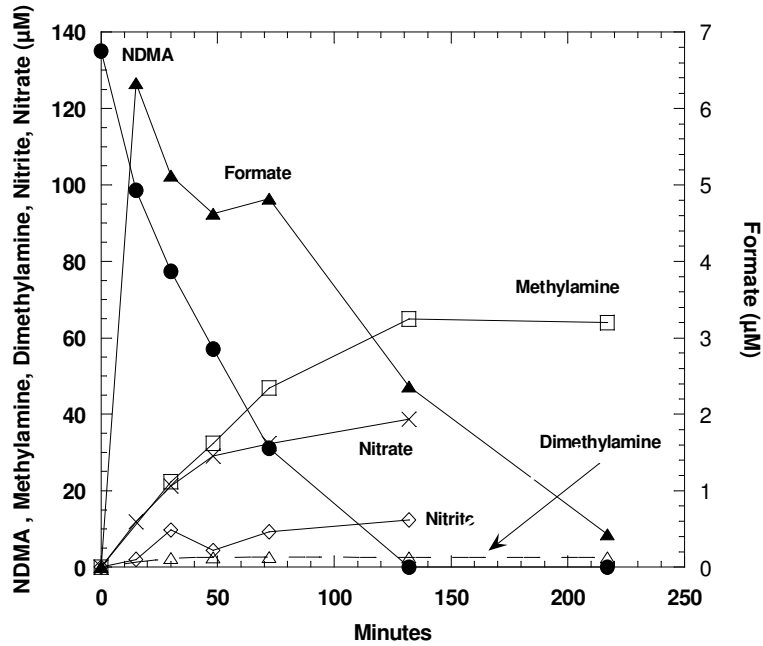


## 2.2 TECHNOLOGY DEVELOPMENT

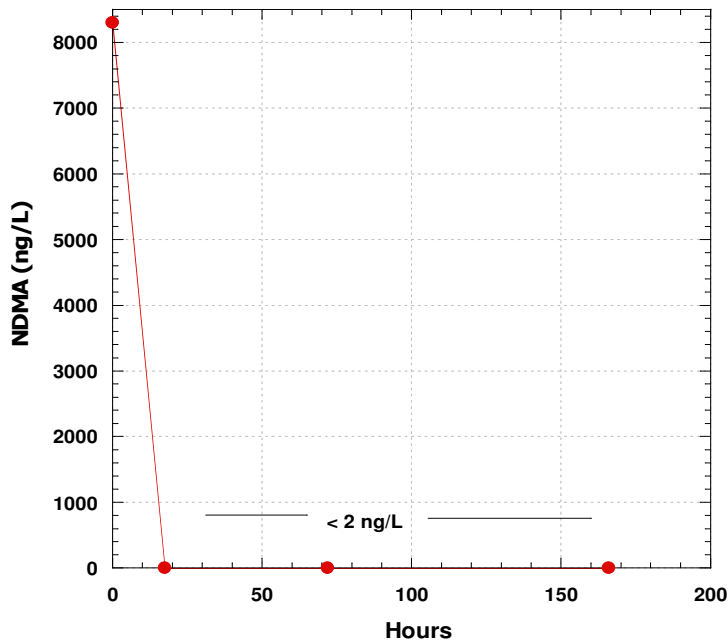
This ESTCP project builds upon the results from SERDP Project ER-1456, the objective of which was to examine the potential for *in situ* and *ex situ* biodegradation of NDMA using co-metabolic approaches (Hatzinger et al., 2008). Similarly, research from SERDP Project ER-1417 (Alvarez-Cohen, 2012) also supports the approach utilized. The key findings of these projects that influence field application are as follows: (1) a variety of propane-oxidizing bacteria including *Rhodococcus ruber* ENV425 and *Rhodococcus* sp. strain RHA1 are capable of degrading NDMA (Fournier et al., 2009; Sharp et al., 2005, 2009); (2) the propanotroph *R. ruber* ENV425 degrades NDMA to innocuous products; including formate, nitrate, nitrite, methylamine, and carbon dioxide (**Figure 2-2**), unlike co-metabolic metabolism of TCE in which a toxic epoxide is formed (Fournier et al., 2009); (3) biodegradation of NDMA from typical groundwater concentrations (e.g., 1-100 µg/L) to low ng/L levels by these organisms is achievable (**Figure 2-3**) (Fournier et al., 2009; Hatzinger et al., 2011); (4) propanotrophs capable of degrading NDMA are indigenous to many different environments, and these organisms can be stimulated to degrade NDMA through the addition of propane and oxygen (**Figure 2-4**); and (5) propane does not appear to be a significant inhibitor of NDMA biodegradation by many

propanotrophs even though the reaction is co-metabolic (Figure 2-5 and Sharp et al., 2010). The key findings of the SERDP project suggest that an *in situ* approach for NDMA treatment based on propane injection can be successful and widely applicable.

**Figure 2-2. Metabolites produced during the oxidation of NDMA by *R. ruber* ENV425 after growth on propane (modified from Fournier et al., 2009).**

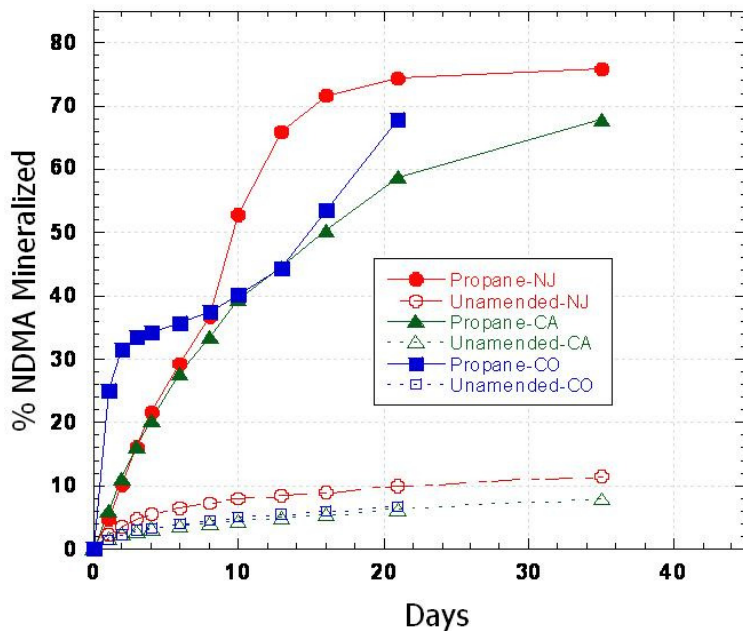


**Figure 2-3. Biodegradation of NDMA by the propanotroph *Rhodococcus ruber* ENV425 in batch culture.** Propane was added to the headspace of the reaction vessel. NDMA levels were below the PQL of 2 ng/L after 18 hr.

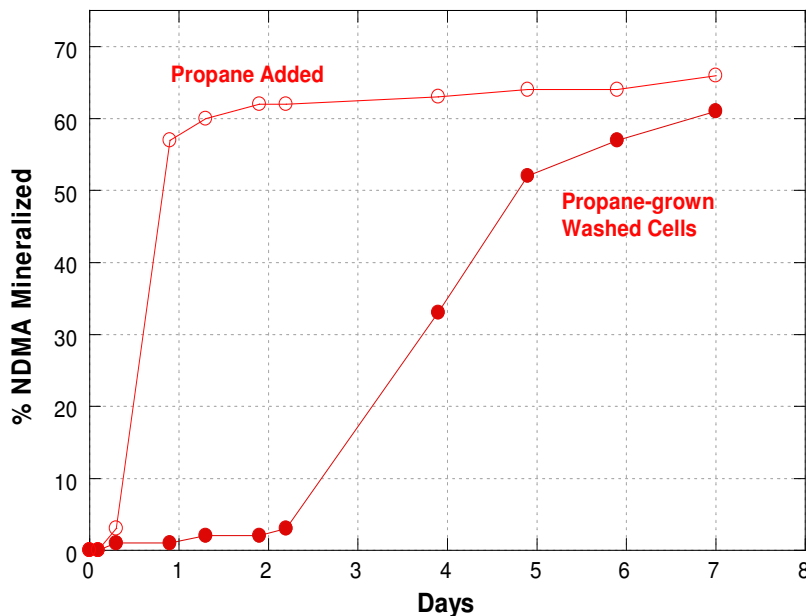




**Figure 2-4. Percent mineralization of  $^{14}\text{C}$ -NDMA to  $^{14}\text{CO}_2$  in microcosms prepared with aquifer solids and groundwater from three different states (NJ, CO, CA). Microcosms were pre-incubated with propane and oxygen (propane) or oxygen only (unamended) for three weeks, then amended with 50  $\mu\text{g/L}$  of NDMA. All propane-treated microcosms showed significant NDMA mineralization.**



**Figure 2-5. Effect of propane on the mineralization of  $^{14}\text{C}$ -NDMA to  $^{14}\text{CO}_2$  by the propanotroph *Rhodococcus ruber* ENV425. Propane added to the headspace of the reaction vessels stimulated NDMA mineralization rather than being inhibitory.**



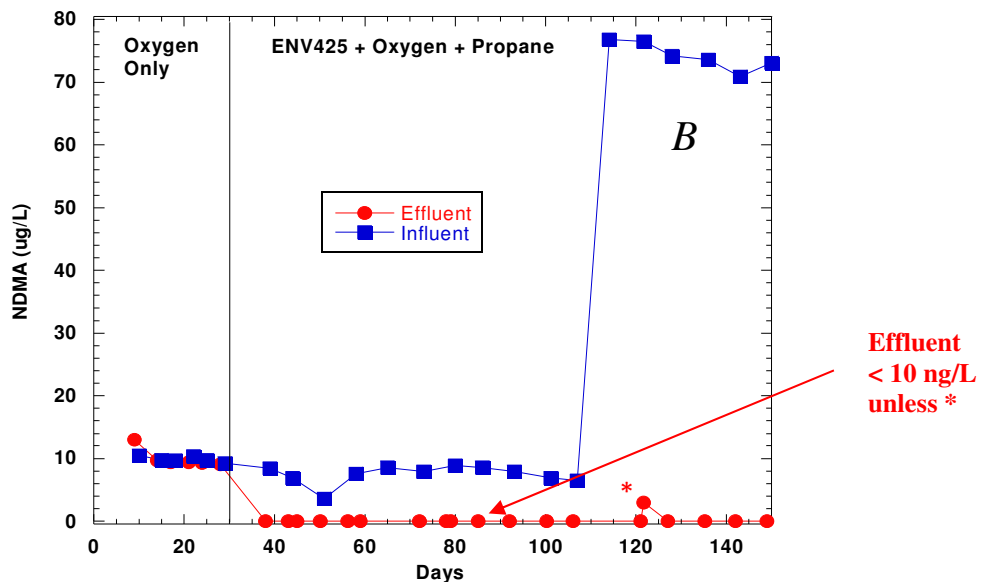
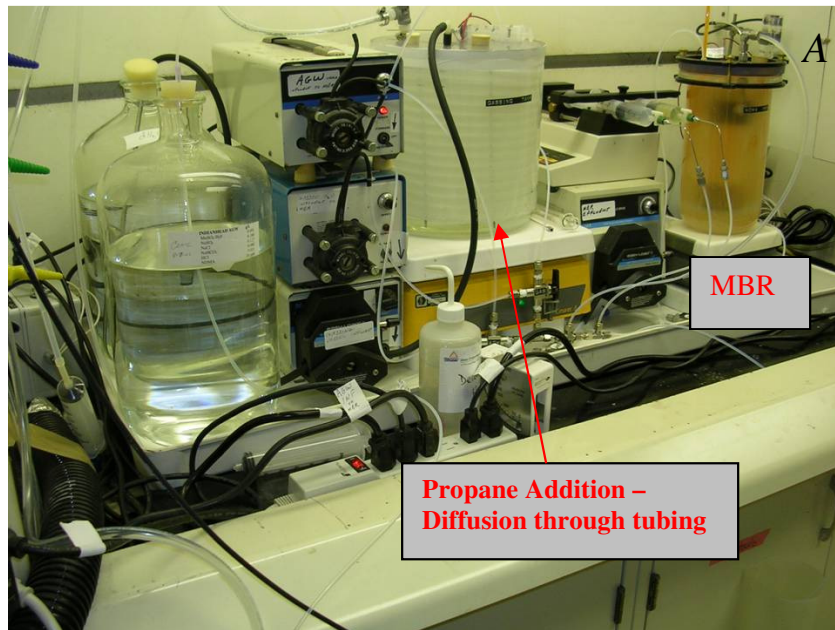
The fundamental concepts supporting this field demonstration were (1) the utilization of aerobic cometabolism for *in situ* degradation of an environmental pollutant, and (2) distribution of gases in the subsurface to stimulate pollutant biodegradation. Each of these concepts was supported by extensive laboratory research and, more recently, field testing. The first publications on co-metabolic reactions and their potential applications for remediation date to the 1960s (Alexander, 1967), and scientific research was conducted on the cometabolism of many different compounds thereafter (Alexander, 1994 and references therein). The observation that methanotrophic bacteria are capable of dehalogenating TCE and other chlorinated ethenes and ethanes (Oldenhuis et al., 1989) and that this process can be stimulated *in situ* (Wilson and Wilson, 1985) resulted in the initial field testing of co-metabolic degradation for chlorinated solvent remediation (Hazen et al., 1991; Semprini and McCarty, 1991). Since this time, co-metabolic degradation of chlorinated solvents by phenol- and toluene-degrading bacteria has been examined in the field (Hopkins and McCarty, 1995; McCarty et al., 1998), and more recently, the application of propane-oxidizing bacteria for *in situ* treatment of chlorinated solvents (Battelle, 2001; Tovanabootr et al., 2001) and gasoline oxygenates (Steffan et al., 2003) has been successfully demonstrated at the field scale.

During our previous research on NDMA biotransformation, we observed that the propanotroph *R. ruber* ENV425 was capable of rapidly biodegrading NDMA to innocuous products, including formate, nitrate, nitrite, methylamine and carbon dioxide (**Figure 2-2**; Fournier et al., 2009; Hatzinger et al., 2008). No toxic intermediates were observed. In addition, results from both batch experiments and a long-term bioreactor study with ENV425 revealed that NDMA treatment levels of < 10 ng/L are readily achievable through biodegradation (**Figures 2-3 & 2-6**; Fournier et al., 2009; Hatzinger et al., 2011, Webster et al., 2013) even in the presence of propane gas in reaction vessels. Thus, inhibition of NDMA biodegradation by propane appears to be much less significant than for other co-metabolic reactions, including oxidation of MTBE and TCE. Results of Sharp et al., (2010) confirmed this hypothesis, as the concentration of propane required to reduce rates of NDMA degradation in half by the propanotroph *Rhodococcus sp.* RR1 was observed to be 7,700 µg/L. In addition to pure culture studies, our research revealed that the addition of propane to aquifer samples from several different locations (sites in CO, NJ, and CA) stimulated the rapid degradation of <sup>14</sup>C-NDMA (50 µg/L starting concentration) to <sup>14</sup>CO<sub>2</sub> (**Figure 2-5**). Pure cultures of Mycobacteria capable of mineralizing NDMA were isolated from each site (data not shown). Thus, our laboratory data suggest that both *in situ* and *ex situ* biological NDMA treatment to ng/L concentrations are feasible via propane addition.

*In situ* remediation of NDMA via co-metabolism requires the addition and distribution of propane gas and oxygen in groundwater. As previously noted, there are several different active and passive approaches to distribute gases in the subsurface, each of which is likely to be applicable at some sites. For this demonstration, we used an air- and propane-biosparging approach. This technology is based on traditional air-sparging (AS) which, coupled with soil vapor extraction (SVE), is presently one of the most widely applied approaches for treating petroleum contamination in the subsurface (Leeson et al., 2002). With AS/SVE, groundwater contaminants are removed by a combination of volatilization (and recovery via SVE) and aerobic biodegradation. Although biosparging is a form of air sparging, the focus is on providing the necessary gases (usually oxygen) for contaminant biodegradation and minimizing volatilization

(USEPA, 1994). Previous field applications of propane biosparging include, most recently, a project at Vandenberg Air Force Base in which the approach was used to successfully remediate 1,4-dioxane along with low concentrations of several chlorinated organic compounds (Lippincott et al., 2015). Other projects include an ESTCP-funded field demonstration conducted at McClellan AFB (CA) to treat chlorinated organic compounds (Battelle, 2001; Tovanabootr et al., 2001), and multiple field demonstrations for treatment of MTBE at gas station sites (Steffan et al., 2003) and at Port Hueneme, CA (Envirogen, 2003). Thus, the general approach of propane biosparging has been field tested. The results from these demonstrations (and the lessons learned) were utilized during the design of this field trial.

**Figure 2-6. Laboratory propane-fed membrane bioreactor treating NDMA (Panel A). Influent and effluent data from the MBR (Panel B).** All effluent points after culture inoculation were < 10 ng/L except that denoted with a \*. Modified from Hatzinger et al., (2011).

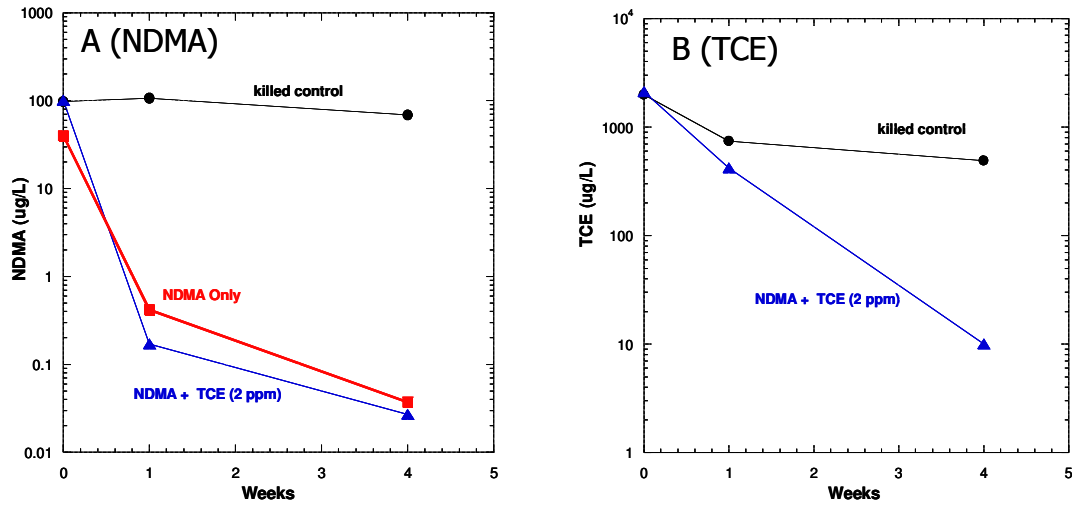


### 2.3 ADVANTAGES AND LIMITATIONS OF THE TECHNOLOGY

As previously discussed, the most effective technology for removing NDMA from water is currently ultraviolet irradiation (UV). However, this *ex situ* technology is expensive, requiring the installation of P&T infrastructure, and banks of UV lights that require significant energy to reduce NDMA to required levels. Propane biosparging for co-metabolic biodegradation of NDMA has several advantages over the current P&T technology. Importantly, the technology is destructive and it can be applied *in situ*, thereby reducing the risk of contaminant exposure, reducing contaminant/media disposal costs, and eliminating groundwater recovery costs. Unlike bioremediation processes that require the degradative bacteria to metabolize and grow on the target contaminant, the co-metabolic approach allows bacteria to grow on the available co-substrate (i.e., propane), allowing it to degrade the contaminant (NDMA) to sub-ng/L concentrations. Such low treatment levels are typically not attainable with metabolic systems because there is insufficient carbon and energy for growth at low contaminant concentrations (Alexander, 1994; Schmidt et al., 1985). Furthermore, the technology is very flexible and can be applied in a wide range of configurations (source area treatment, *in situ* permeable barriers, recirculation systems, etc.), and it relies on the use of a very low cost substrate (i.e., propane). It also may allow the simultaneous treatment of multiple co-contaminants (chlorinated ethenes, chlorinated ethanes, NDMA, etc.; Tovanabootr et al., 2001; Battelle, 2001).

In addition to its many advantages, the technology may have some disadvantages. For example, successful application of the technology requires the presence of propane oxidizing bacteria that can degrade the target contaminant. At some sites, indigenous bacteria able to degrade propane and NDMA may not be abundant. In these cases, bioaugmentation with organisms such as *R. ruber* ENV425 may be required (e.g., Lippincott et al., 2015). Likewise, at some sites, achieving and demonstrating adequate distribution of injected gases (propane and oxygen) may be challenged by site hydrogeology. These same conditions, however, would likely also limit the implementation of other *in situ*, and possibly *ex situ* technologies. Finally, successful application of the technology could be inhibited by the presence of certain co-contaminants. For example, high concentrations of chlorinated ethenes could poison the propanotrophic bacteria via the formation of toxic metabolites, such as TCE-epoxide, as was observed in a bioreactor study (Hatzinger et al., 2011). However, with a longer residence time in the field, it may be possible to treat both NDMA various chlorinated solvents with this approach, despite the formation of metabolites. For example, in samples from a site in New Jersey, both NDMA and TCE were biodegraded simultaneously over a period of 4 weeks in samples amended with propane gas and oxygen (**Figure 2-7**; Hatzinger et al., 2008). The potential for treatment of co-contaminants using this approach can be assessed by performing site-specific treatability testing.

**Figure 2-7. Biodegradation of NDMA (panel A) and TCE (panel B) by indigenous bacteria in aquifer samples from New Jersey.** All microcosms (except the controls) were pre-incubated with propane for 2 weeks prior to addition of NDMA or NDMA/TCE to stimulate propane-oxidizing bacteria.



### 3.0 PERFORMANCE OBJECTIVES

Performance objectives are summarized in **Table 3-1**, and detailed descriptions of objectives are provided in **Sections 3.1** through **3.5**.

**Table 3-1. Performance Objectives.**

| Performance Objective                                | Data Requirements   | Success Criteria   | Results  |
|--|---|--|--|
| <b>Quantitative Performance Objectives</b>           |   |  |  |
| Determine effectiveness of NDMA treatment            | Pre- and post-treatment contaminant concentrations in groundwater monitoring wells using EPA Method 521.  | <ul style="list-style-type: none"> <li>Reduction to &lt; 3 ng/L (OEHHA Public Health Goal) in one or more treatment zone or downgradient (performance) groundwater monitoring wells</li> <li>Overall NDMA reduction in treatment zone and closest downgradient MWs of &gt; 99 %</li> <li>Comparison of treatment zone, downgradient and background groundwater monitoring well data</li> </ul> | <ul style="list-style-type: none"> <li>Degradation of NDMA to &lt; 3 ng/L was achieved in one of the monitoring wells (PMW-2), which had baseline concentrations as high as 25,000 µg/L.</li> <li>Overall reduction in NDMA of &gt; 99.7% was achieved in the closest treatment zone MWs.</li> </ul> |
| Adequate distribution of gases in groundwater        | <p>Pre-demonstration tracer studies using air sparging (measure increases in DO). Initial concentrations of propane in treatment wells at system start-up.</p> <p>Measurements of propane via EPA 3810, RSK-175 and DO via field meter in groundwater monitoring wells.</p> | <ul style="list-style-type: none"> <li>Increased DO in expected treatment zone during preliminary biosparge tests. Increased DO and propane in first row of treatment zone groundwater monitoring wells during demonstration start-up. Declining concentrations of both gases in downgradient wells as predicted based on site model and laboratory treatability tests.</li> </ul>             | <ul style="list-style-type: none"> <li>Adequate gas distribution was documented at a 12.5 ft radius of influence in preliminary testing</li> <li>DO increases in local monitoring wells were documented.</li> <li>Propane consumption in treatment zone monitoring wells was documented</li> </ul>   |
| Minimal negative impacts to groundwater geochemistry | Measurements of DO, pH, ORP, nitrate, sulfate   | DO > 2 mg/L;<br>pH varying by < 1 SU;<br>ORP > + 100 mV  | <ul style="list-style-type: none"> <li>No negative impacts to groundwater geochemistry were observed</li> </ul>  |
| Increase in propanotroph population                  | qPCR  | Increase in total propanotrophs by ≥ 1 log order in treatment plot wells   | <ul style="list-style-type: none"> <li>&gt; 1 log order increase in total propanotrophs was observed by qPCR</li> </ul>  |
| <b>Qualitative Performance Objectives</b>            |   |  |  |
| System reliability                                   | <p>Feedback from field technician</p> <p>PLC data logs, maintenance logs &amp; time</p>   | System operates with minimal shut-down time (<10%) and necessity for unplanned maintenance/repair  | <ul style="list-style-type: none"> <li>After initial optimization, system proved to be reliable.</li> </ul>  |

### **3.1 DETERMINE EFFECTIVENESS OF NDMA TREATMENT**

The effectiveness of the biosparging technology for groundwater remediation is a function of the degree to which NDMA concentrations decrease. Remediation success depends on the residual contamination during and after application of the co-metabolic treatment remedy. To evaluate effectiveness, NDMA concentrations in groundwater were monitored in a series of performance monitoring wells (PMWs), three of which (PMW-2, PMW-3, PMW-4) were within or slightly downgradient of the expected zone of influence of the biosparge wells (BW-6, BW-7, PMW-1) (**Figure 3-1**). It should be noted that PMW-1 was used as both a biosparge well and a performance monitoring well throughout the demonstration. Wells PMW-5 and PMW-6 were downgradient of the plot and expected to be influenced later in the demonstration, as treated water reached this region. Well BMW-1, which was sidegradient (~ 75 ft west of the center of the biosparge zone; not shown in **Figure 3-1**; see **Figure 5-16**.), was used as a control well to monitor NDMA concentrations outside of the treatment zone.

#### **3.1.1 Data Requirements for NDMA Treatment Effectiveness**

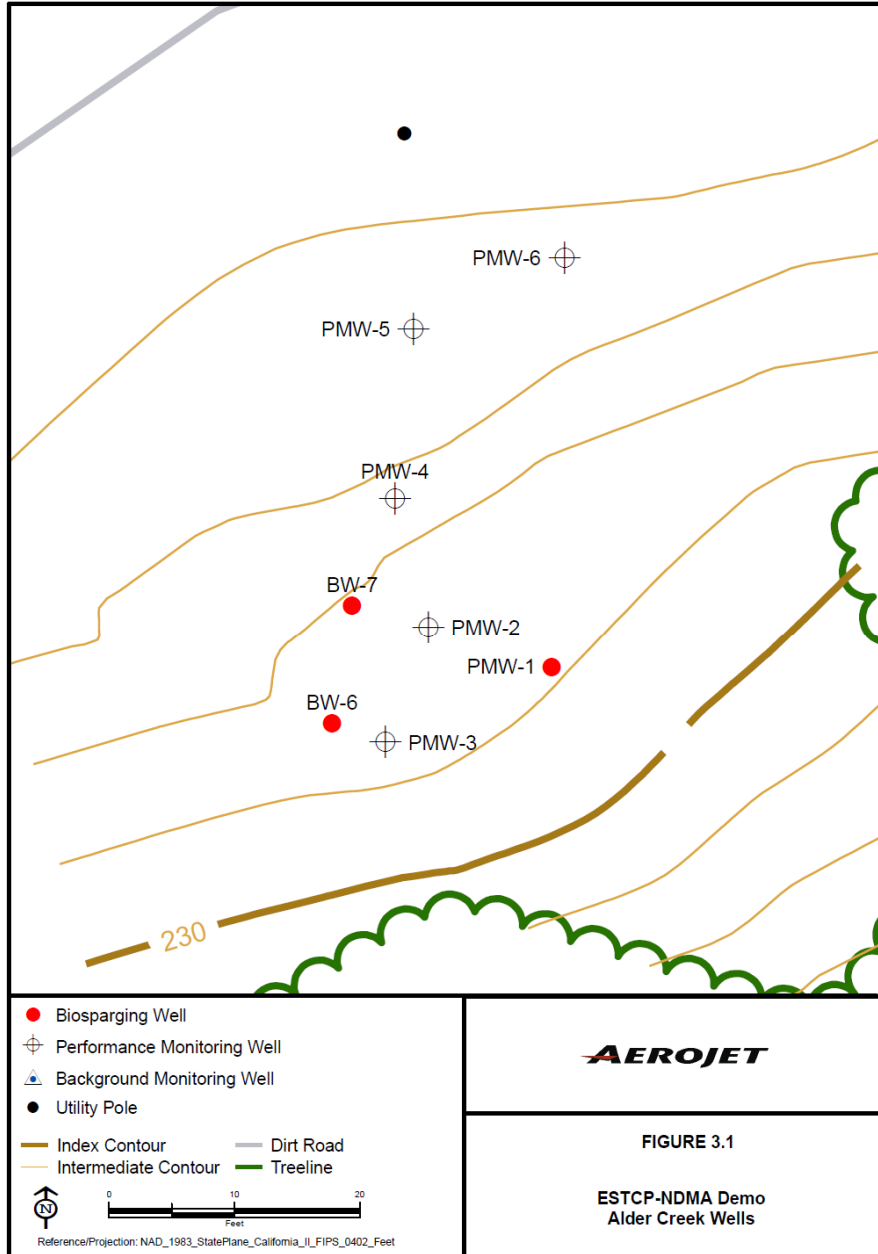
Two rounds of groundwater samples were collected from all performance monitoring wells prior to initiating propane and oxygen gas addition (Day -70 and Day -84), and nine additional rounds were conducted between Day 0 and Day 353 when propane biosparging was occurring. Two additional rounds of sampling occurred to evaluate rebound after the system was shut down (Day 385, Day 430). Typically, the wells that were sampled included four wells within the biosparge zone (PMW-1, PMW-2, PMW-3, PMW-4), two wells downgradient of the biosparge zone (PMW-5, PMW-6), and one sidegradient control well (BMW-1). Biosparge wells BW-5 and BW-6 also were sampled on a few occasions. Treatment effectiveness was measured by comparing NDMA concentrations in each monitoring well before and after propane biosparging, and by comparing data from the background monitoring well with those of the treatment zone and downgradient monitoring wells during gas addition. All NDMA analyses were conducted by EPA Method 521 with a minimum detection limit (MDL) of 2 ng/L (sometimes slightly higher if samples had turbidity). A California-certified laboratory was used for NDMA analysis.

#### **3.1.2 Success Criteria for NDMA Treatment Effectiveness**

The key performance objectives were considered to be met if (1) there was > 99% overall reduction in NDMA concentrations throughout the treatment plot from the pre-treatment to the post-treatment phase, and (2) if NDMA concentrations of < 3 ng/L (the current California Public Health Goal for NDMA in water; OEHHA, 2006) were achieved in at least one of the performance monitoring wells. Both objectives were met. From baseline sampling (average concentrations from Day -70 and Day -84) to the final day of system operation on Day 353, concentrations of NDMA declined by 99.7% to > 99.9% in the four PMWs within the zone of influence of the biosparge system. Baseline concentrations ranging from 18,500 to 27,500 ng/L (average of two baseline events) declined to between 2.7 and 72 ng/L by Day 353. Well PMW-2 was below 3 ng/L on Day 353. By comparison, the NDMA concentration in the sidegradient control well (BMW-1) averaged 36,000 ng/L during baseline sampling and was 31,000 ng/L on Day 353, a decline of only 14%. Concentrations of NDMA in the far downgradient wells PMW-5 and PMW-6 began to show significant declines only near the end of the demonstration, after

the sparging system was shut off, presumably as treated water from the biosparge plot began to reach this region of the aquifer. Full results are provided in **Section 5.7.1**.

**Figure 3-1. Layout of final biosparging test plot.**

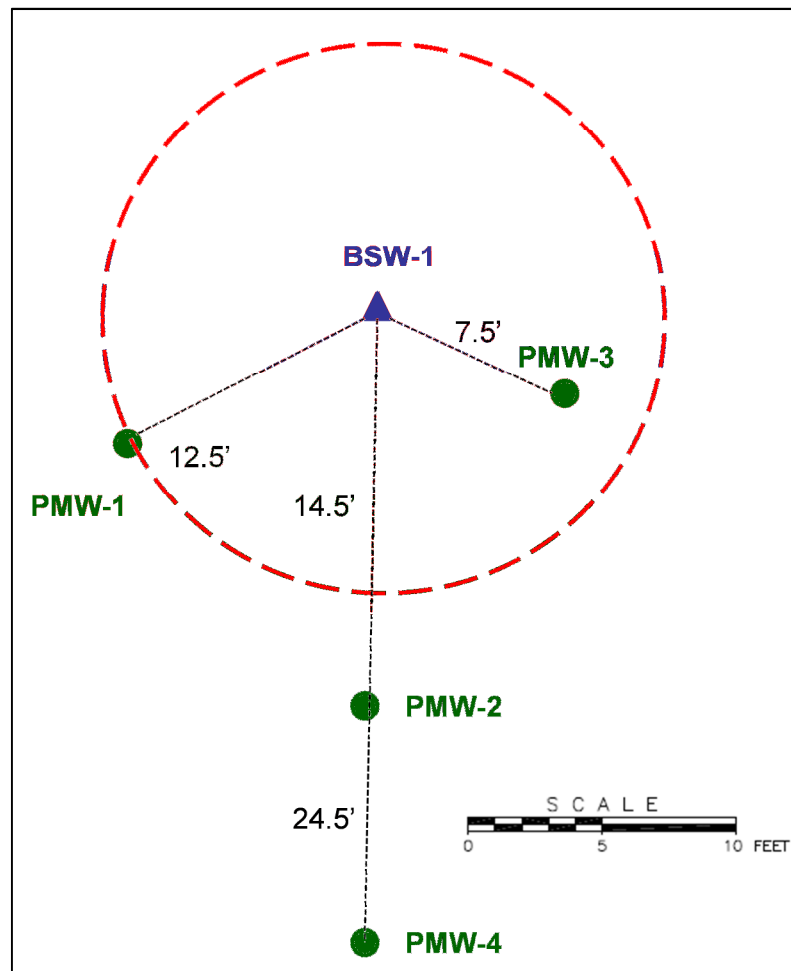




### 3.2 ADEQUATE DISTRIBUTION OF GASES IN GROUNDWATER

Adequate gas distribution is critical to the success of this or any biosparging approach. The distribution of gases was initially tested by installing one gas injection well and four monitoring wells, and then using a gas injection test with air (to supply O<sub>2</sub>) to evaluate the distribution radius (Figure 3-2). During this test, dissolved O<sub>2</sub> was monitored at the wells as a function of sparging time using field meters. Sulfur hexafluoride (SF<sub>6</sub>) has been used as a conservative gas tracer during biosparging studies (Johnson et al., 2001; Bruce et al., 2001; Leeson et al., 2002). However, this gas is now considered an emerging contaminant by the DoD due to its high potency as a greenhouse gas (> 23,000 times the global warming potential (GWP) of CO<sub>2</sub>) (USEPA, 2011b), and its use as a tracer is no longer recommended. The demonstration site had a low concentration of dissolved O<sub>2</sub> (< 1 mg/L) and a relatively low oxidation-reduction potential ORP (~ -100 mV) prior to sparging. However, the presence of nitrate and sulfate in the local groundwater suggested that conditions were not anaerobic, but merely anoxic, thus allowing for use of oxygen from air sparging as a tracer (i.e., abiotic consumption of oxygen was not expected to be high). The presence of bubbles in monitoring wells and groundwater mounding also were used as signs of sparging radius during the initial gas distribution tests (see next section). In addition to sparge radius testing, concentrations of both propane and oxygen were monitored throughout the demonstration to evaluate gas distribution in the treatment plot.

**Figure 3-2. Initial wells installed for gas distribution testing.**



### 3.2.1 Data Requirements for Gas Distribution

The data requirements for the gas distribution testing in monitoring wells located nearby the gas injection well (7.5 ft, 12.5 ft, 14 ft and 24 ft from the injection well; **Figure 3-2**) were as follows: (1) the measurement of dissolved oxygen (DO) using a field meter, (2) qualitative descriptions of any observed bubbling (i.e., none, trace, low, moderate, rapid), and (3) any increase in water table elevation (which may indicate air pocket formation). ORP was also monitored in the field although changes may require a longer period than that allotted for the testing. The air injection pressure was monitored to ensure that the soil overburden pressure was not exceeded, and to provide an accurate measure of the pressure-adjusted gas flow rate. Calibrated YSI field meters were used to measure both DO and ORP during the initial injection test. The data collected from this test was used to locate the remaining sparge wells.

The procedure for the oxygen distribution testing entailed air injection into the test well (BSW-1) at flow rates ranging from 0.5 to 5.0 standard cubic ft per minute (SCFM) over a period of ~ 2.5 to 5 hrs (multiple tests were performed). Oxygen/gas distribution, ORP, bubbling and mounding were measured as described in the previous paragraph during this period of time. During the actual demonstration, concentration of O<sub>2</sub> and propane in groundwater were measured at all monitoring wells to confirm gas distribution. The early time points (prior to significant propane biodegradation) were considered the most important to evaluate and compare propane distribution to that of O<sub>2</sub>. Propane was measured in CB&I's Lawrenceville NJ laboratory via gas chromatography (GC) and O<sub>2</sub> was measured in the field using a meter as detailed previously.

### 3.2.2 Success Criteria for Gas Distribution

The success criteria for gas distribution for the initial gas injection test was the observation of mounding, bubbling, and/or an increase of at least 0.5 mg/L DO above baseline in the closest monitoring locations adjacent to the air injection well within the allotted testing period. Groundwater mounding of ~ 0.4 ft or greater was observed at all four of the MWs during the air sparge tests. An increase in DO of ~ 0.6 mg/L and bubbling was recorded at PMW-1, (which was located ~ 12.5 ft from air sparge well BSW-1), at 5 SCFM. Bubbling was also recorded at PMW-3 at a sparge rate of 5 SCFM, although a consistent increase in DO was not observed (an initial increase from 0.25 to 0.55 mg/L DO was observed, but this value fell back to 0.37 mg/L during the sparge test). No bubbling or DO increase was observed at PMW-2 (14.5 ft) or PMW-4 (24.5 ft). The data suggest that there is site heterogeneity, as expected, but also provide reasonable assurance that sparging would supply necessary gases within a reasonable radius from the sparge well (i.e., 12.5 ft). It should also be noted that sparge well BSW-1 was screened over a 20 ft interval, and potentially multiple conductive layers, so some of the air is likely to have flowed preferentially through layers not intersected by the MW screens.

Within two weeks after system start-up at Day 0, the DO in PMW-1, PMW-2, PMW-3 and PMW-4 increased to > 10 mg/L, suggesting that oxygen was distributed throughout the local treatment area. Propane was also detected between ~ 20 and 300 µg/L in these wells at Day 14 again showing that gas was being distributed. However, as noted later in this report (**Section 5.4.1**) only one sparge well (of 5 installed) was operating during the initial start-up due to issues with the sparge screens, and that well (BW-4) became inoperable shortly thereafter. As a result,

PMW-1 was used as a sparge well beginning on Day 0, and two additional sparge wells (BW-6, BW-7) were installed between sampling events on Day 112 and Day 133. The addition of these wells significantly increased the propane concentrations in PMW-1, PMW-2, and PMW-3 (> 500 µg/L) and the overall amount of propane supplied to the demonstration plot. PMW-4 also had detectable propane albeit at lower concentrations than the other three wells. Thus, good gas distribution in the treatment area was documented. Full results are provided in **Section 5.7**.

### **3.3 MINIMAL NEGATIVE IMPACTS TO GROUNDWATER GEOCHEMISTRY**

During the demonstration, it was desirable for the biosparging approach to have minimal large-scale negative impacts on aquifer geochemistry. The chosen test location in OU 4 has groundwater that has low oxygen (DO ~ 1 mg/L), with a slightly negative ORP (~ -100 mV depending on the well) and a neutral pH. At the Aerojet site, because of the presence of local pumping wells, a significant reduction in ORP (which leads to metals mobilization and/or growth of iron-oxidizing bacteria and other organisms typically involved in well fouling) is not desirable. Thus, geochemical parameters were closely monitored during the demonstration.

#### **3.3.1 Data Requirements for Geochemical Changes**

The parameters that were measured to assess potential groundwater geochemical changes are as follows:

1. DO by field meter;
2. Oxidation-Reduction Potential (ORP) by field meter; and
3. pH by field meter.

#### **3.3.2 Success Criteria for Geochemical Changes**

The success criteria for measured geochemical changes were as follows:

1. DO > 2 mg/L in treatment zone performance monitoring wells;
2. ORP rising to > +100 mV in treatment zone performance monitoring wells during active air addition; and
3. pH changes < 1 standard unit (SU) from baseline in all PMWs.

Overall, the stated success criteria were met, and there were no negative impacts on groundwater geochemistry in the plot area. DO increased throughout the demonstration area PMWs to > 10 mg/L during active sparging. DO increases of similar magnitude were observed in downgradient well PMW-5 after installation of additional sparge wells (BW-6, BW-7), and DO in downgradient well PMW-6 also increased to near 10 mg/L by the end of the demonstration. Slight increases in DO were detected in control well BMW-1, but the maximum DO was 5 mg/L and the concentration decreased after Day 300. The fluctuations in DO concentrations at this well could be due to seasonal variations, or potentially from limited impacts from biosparging. The ORP in the demonstration plot wells was near or greater than +100 mV for a majority of the demonstration. However, the ORP in background well BMW-1 tended to vary in conjunction with the ORP in the PMWs during several events. The reason for this co-variation is unclear.

However, it appears that DO was a better measure of the sparge system impact on site groundwater than ORP. The full results are provided in **Section 5.7**.

The pH in the demonstration plot generally remained between 6.5 and 7 during the demonstration. This pH was slightly elevated in PMW-1 (which was used as both a sparge well and a monitoring well) during some events, but did not exceed 7.5 SU. The full results are provided in **Section 5.7**.

### **3.4 INCREASE IN PROPANOTROPH POPULATION**

The key to successful *in situ* co-metabolic biosparging for remediation of NDMA and other contaminants is the growth and proliferation of indigenous or added propane oxidizing bacteria (propanotrophs). Performance of these organisms can be assessed by measuring propane and oxygen utilization and/or measuring their abundance in the aquifer.

#### **3.4.1 Data Requirements for Propanotroph Population**

Total propanotrophs were measured as a function of time in wells PMW-2 through PMW-5 and in background well BMW-1. Groundwater samples were collected and submitted to Microbial Insights for analysis of the propane monooxygenase gene (PMO) by quantitative polymerase chain reaction (qPCR). Values from background and treatment wells also were compared.

#### **3.4.2 Success Criteria for Propanotroph Population**

A 10x (1 log order) increase in propanotrophs in the treatment wells (PMW-2, PMW-3, PMW-4) relative to pre-treatment concentrations (between  $2 \times 10^3$  and  $3 \times 10^4$  cells/mL) was the criterion for successful stimulation of propanotrophs in the aquifer. Increases in cell numbers were also expected in downgradient monitoring wells, but not to the extent of those expected in the treatment zone performance monitoring wells. The success criterion was met, with the propanotroph density in wells PMW-2, PMW-3, and PMW-4 each increasing by greater than 1 log order over the course of the demonstration. On Day 311, the final day of sampling during active bioaparging, the propanotroph density in these three wells ranged from  $2 \times 10^5$  to  $6 \times 10^5$  cells/mL. The propanotroph population in each of these wells remained reasonably constant thereafter, even in the absence of propane addition, for more than 80 days. By comparison, the cell density in BMW-1 declined from  $2 \times 10^4$  to  $6 \times 10^3$  cells/mL over the entire course of the demonstration. The full results are provided in **Section 5.7**.

### **3.5 SYSTEM RELIABILITY**

As discussed in **Section 2.1**, we used an air- and propane-biosparging approach for this demonstration. This technology is based on traditional air-sparging, one of the most widely applied approaches for treating petroleum contamination in the subsurface (Leeson et al., 2002). Although biosparging is a form of air sparging, the focus is on providing the necessary gases (usually oxygen) for contaminant biodegradation and minimizing volatilization (USEPA, 1994). Therefore, the proposed biosparging system used during this demonstration was expected to operate reliably with minimal requirement for maintenance after start-up.

### **3.5.1 Data Requirements for System Reliability**

The system reliability was evaluated qualitatively through discussions with field personnel, and quantitatively by evaluating operational data (flows and LEL) collected from the Programmable Logic Controller (PLC) on the biosparging system, total time down for unplanned maintenance/repair (documented in field book), and total costs of the unplanned maintenance/repair (tracked via personnel hrs and replacement parts/materials).

### **3.5.2 Success Criteria for System Reliability**

The qualitative success criterion for system operation was “minimal” unplanned maintenance/repair and cost. Quantitatively, the system should operate a minimum of 90 percent of the time, and should require no more than 15% additional field technician time per month than planned for routine checks and assessment. Data collected by the PLC from June 26, 2012 (after additional sparging wells were installed) through February 20, 2013, showed that the system operated within design parameters (e.g., air flow and propane delivery) for 233 out of 240 days, or 97 percent of the time. Additionally, no significant maintenance or repairs to the system were required during this period. Thus, the system met its requirement for reliability. Repairs to the system that were made during operation included the replacement of a needle valve, a solenoid valve, and the LEL meter (at the end of the demonstration). Considering the biosparging system used during the demonstration was >10 years old, these repairs were not unexpected. Maintenance to the system (beyond routine checks and flow adjustments) primarily included replacement of spent propane cylinders, the installation of a heating blanket for the propane cylinder, and the installation of heat trace tape to propane delivery lines on the system.

## 4.0 SITE DESCRIPTION

### 4.1 SITE LOCATION AND HISTORY

The Aerojet facility is located in eastern Sacramento County, California, approximately 15 miles east of Sacramento (**Figure 4-1**). Approximately 5,900 acres of the 8,500 acre site are included in the Aerojet Superfund Site, which has been used to develop rocket propulsion systems in support of national defense, space exploration, and satellite deployment since the 1950s (Tetra Tech, 2008). Industrial activities that supported and continue to support this work include solid rocket motor manufacturing and testing, liquid rocket engine manufacturing and testing, chemical manufacturing, and disposal of materials (Tetra Tech, 2008). During the development of rocket propulsion systems, various chemicals were used, including solvents, propellants, fuels, oxidizers, metals, and explosives. Historic operations at the facility resulted in the discharge of some of these chemicals to the subsurface.

Aerojet has been performing site investigation work since 1979 to determine the nature and extent of historical contamination at the facility. As part of the investigation process, the site has been divided into several Operable Units (OUs). Although numerous chemicals have been used at Aerojet, trichloroethene (TCE), perchlorate, and NDMA are the most prevalent chemicals encountered in the vadose zone and groundwater (Tetra Tech, 2008). In 1989, Aerojet entered into a Partial Consent Decree (PCD) with the United States Environmental Protection Agency (USEPA) which established procedures and obligations toward achieving specified goals, including completing a Remedial Investigation/Feasibility Study (RI/FS) program. This program is currently ongoing.

The former operations at the Aerojet facility in Zone 4 of the Eastern Operable Unit (OU), where the demonstration was conducted, were primarily to support the development and testing of liquid rocket engines, including those used in the Titan and Apollo programs. Liquid rocket testing at Zone 4 has been conducted since 1967, and portions of the area remain active. Current activities conducted in the area are associated with liquid rocket engine and component testing. Support operations and equipment include new rocket propellant characterization, liquid rocket engine cleaning, solvent storage, test stands, and disposal areas. Twenty-three potential source areas have been identified within the liquid rocket test area of Zone 4. The substances handled in these operations included a variety of solvents, fuels and oxidizers (including unsymmetrical dimethyl hydrazine and hydrazine, which are the likely sources of NDMA in groundwater), various metals, nitric and hydroxyacetic acid, hydraulic oils, motor oils, PCBs, and miscellaneous other chemicals.

Groundwater Extraction and Treatment Facility A (GET A) captures and treats NDMA-contaminated groundwater in Zone 4 of the Eastern OU. The GET A extraction well field currently consists of sixteen extraction wells and has been operating since 1986 (the original configuration consisted of 10 extraction wells). Billions of gallons of groundwater have been treated by the GET A facility. The system utilizes UV light to destroy NDMA. Hydrogen peroxide is added to the UV system (UV/oxidation) for removal of some VOCs and potentially 1,4-dioxane. Following UV/oxidation, the remaining VOCs are removed via an air-stripper.

The groundwater treated at GET A is discharged to Rebel Hill ditch and infiltrates into dredge tailings (Central Valley Environmental, 2005).

The selected TPA is in the northeast corner (Zone 4) of Eastern OU, as shown in **Figure 4-2**. The general location for the demonstration was based on discussions with Mr. Scott Neville, an Environmental Project Manager at Aerojet. Several different locations were considered for the TPA, and soil cores and groundwater samples were collected at three locations from two separate areas during site selection work. Based on existing site data, and the ESTCP site characterization activities (**Section 5.2**), the TPA was located in the vicinity of Alder Creek, just south of Extraction Well 4125 (EW 4125). **Figure 4-3** shows the different TPA locations that were evaluated for the demonstration. Site characterization activities that were performed in these locations are detailed in **Section 5.2**.

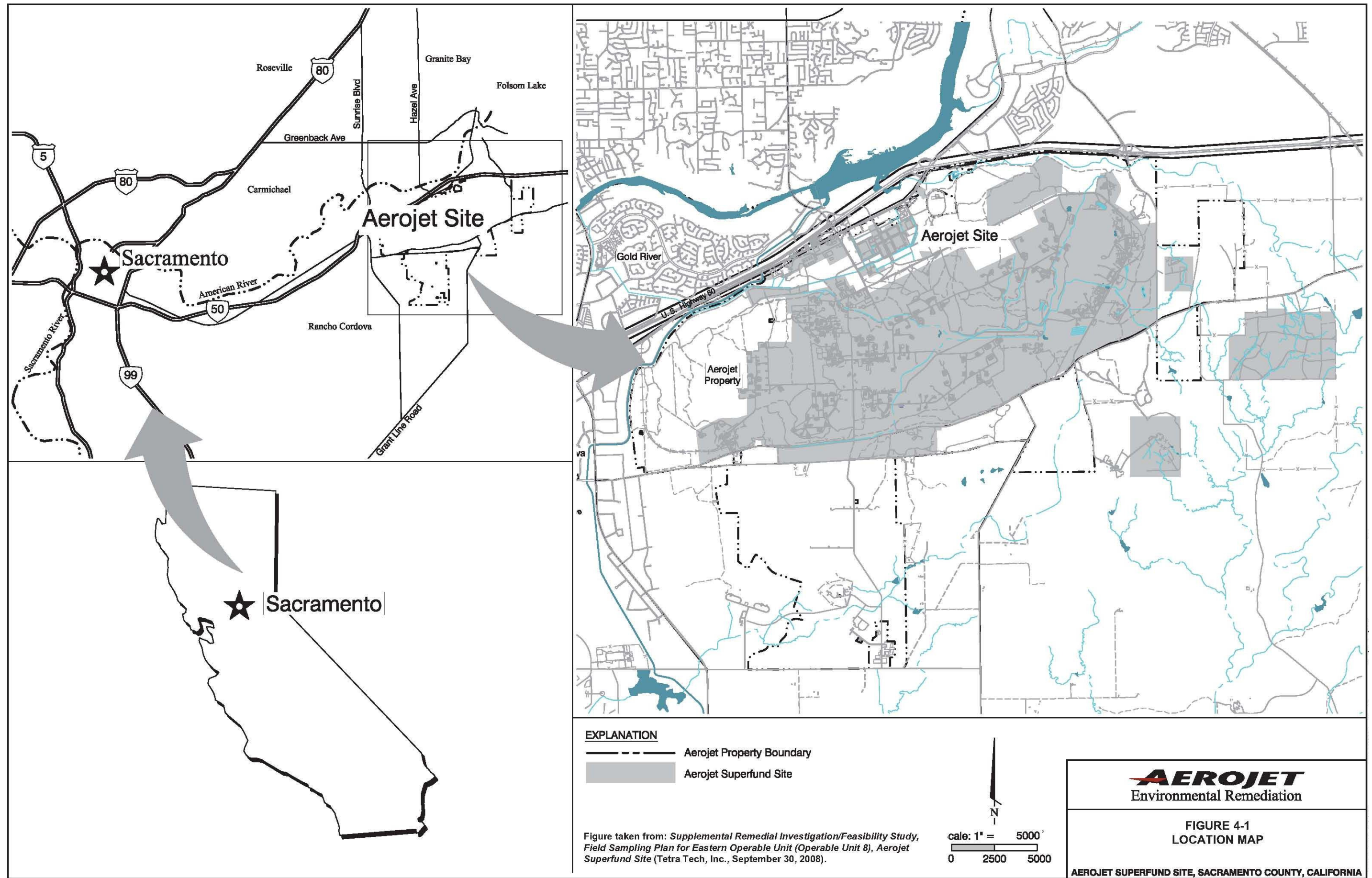
A comprehensive *Site Selection Memorandum* was submitted to ESTCP on June 24, 2009, and it was subsequently approved. The memorandum evaluated several sites and provided evaluation criteria that led to selection of the Aerojet site in Sacramento, CA for this demonstration. The TPA location was selected after a site visit, discussions with Aerojet personnel, core and groundwater sample collection and analysis, and the results of a comprehensive laboratory treatability study, which ultimately resulted in a change of demonstration area from a region with VOCs in groundwater to one with NDMA only (**Section 5.3**).

The following criteria were favorable and led to the selection of this test location near EW 4125:

- 1) This region had historically high concentrations of NDMA (~ 20-30 µg/L) due to previous testing of liquid rocket propellants.
- 2) Contaminated groundwater was relatively shallow (approximately 50-80 ft bgs).
- 3) Electrical service was installed and available.
- 4) Access was year round and not subject to flooding.
- 5) The site was secure.
- 6) TCE and Freon-113 were not present as co-contaminants in this region.
- 7) The downgradient groundwater was being captured by the GET A system.

Some of the difficulties with this area include:

- 1) Downgradient of steep terrain, so space was limited.
- 2) Upgradient of active extraction well (but well only operating at 5 GPM).
- 3) Complex geology.
- 4) Potential for high rate of groundwater flow in regional aquifer.
- 5) Relatively low groundwater DO (< 1 mg/L) and ORP (-100 mV), although nitrate and sulfate were present suggesting the aquifer was merely anoxic (rather than highly anaerobic).





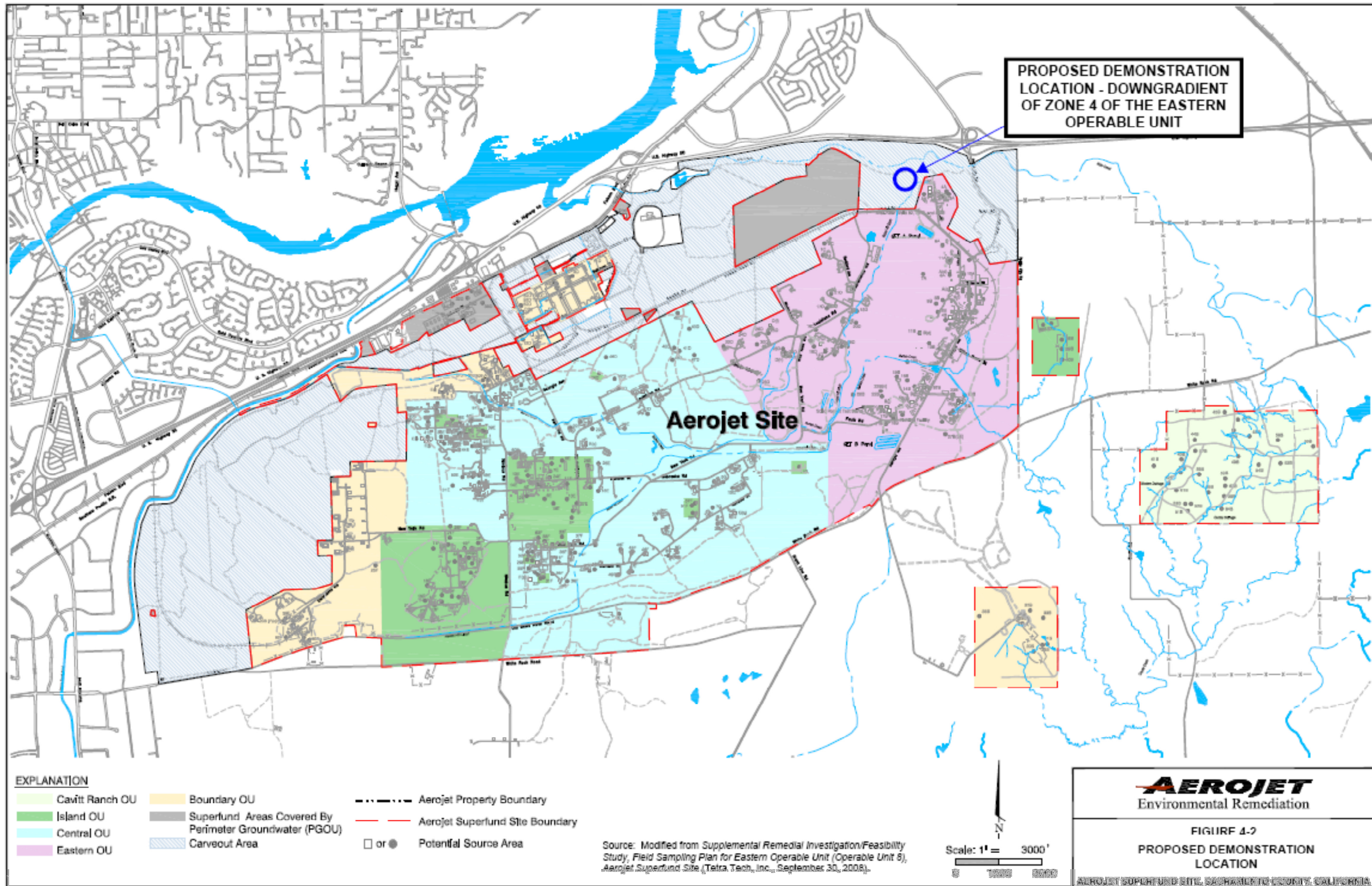
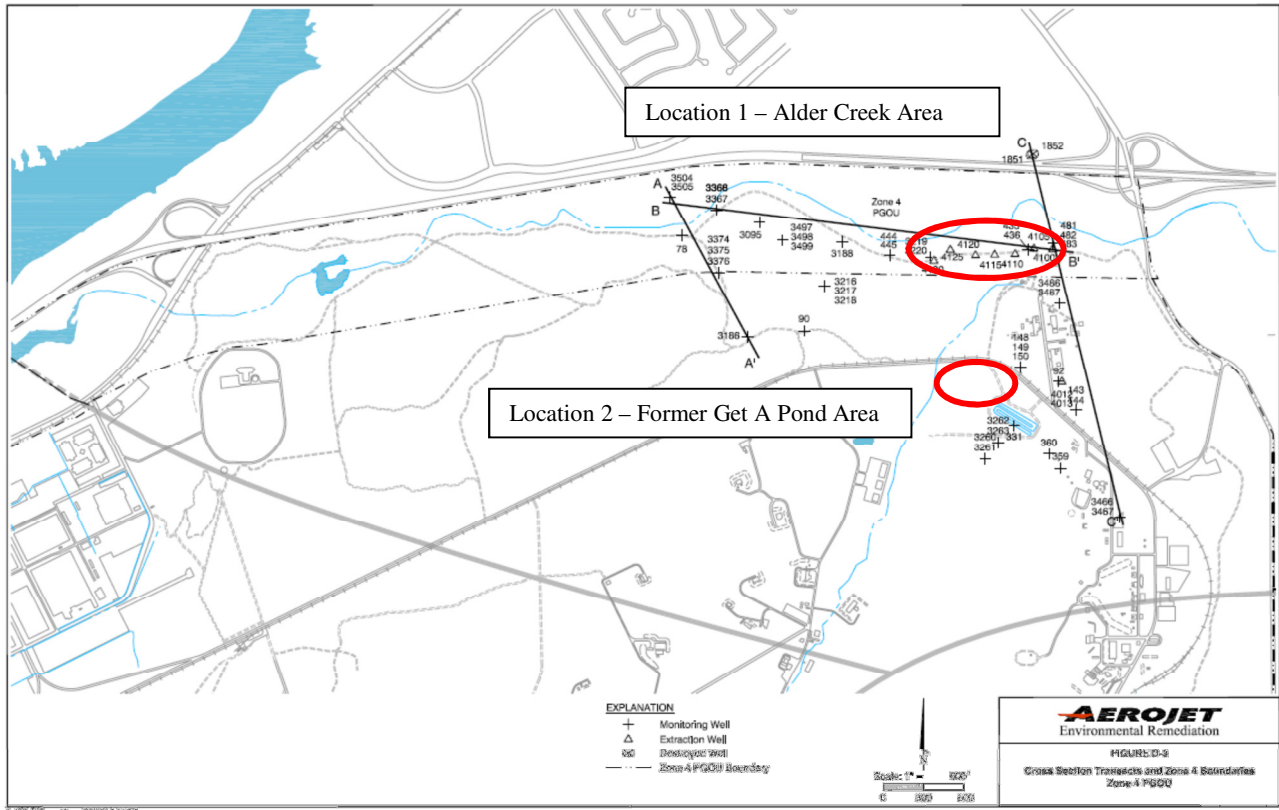


FIGURE 1-2 Herron, AI 9/15/08

10124256

**Figure 4-3. Locations of site investigation work conducted to determine the best location for the Test Plot Area.**



## 4.2 SITE GEOLOGY/HYDROGEOLOGY

The following presents the site geology and hydrogeology, as detailed in the *Supplemental Remedial Investigation/Feasibility Study, Field Sampling Plan for Eastern Operable Unit (Operable Unit 8), Aerojet Superfund Site* (Tetra Tech, 2008).

The Aerojet site is located in eastern Sacramento County near the transition zone between the Great Valley and Sierra Nevada geomorphic provinces (**Figure 4-4**). The geology of the Great Valley, as summarized by Hackel (1966), can be described as a large elongate northwest-trending asymmetric trough. This trough is filled with a very thick sequence (up to 60,000 ft) of sediments of primarily marine origin ranging in age from Jurassic to recent. The sediments that compose the eastern flank of the Great Valley (where Aerojet is situated) thin dramatically as they approach the foothills of the Sierra Nevada and eventually thin out completely, exposing the underlying crystalline basement rocks of pre-Tertiary age igneous and metamorphic rocks that make up the Sierra Nevada Mountain Range.

Aerojet is underlain by fluvial and marine sedimentary deposits ranging in age from Cretaceous to Recent. These sedimentary deposits unconformably overlie Jurassic-aged metamorphic basement rocks that dip to the west. These sediments form a wedge, which thickens from east to west, across the Aerojet site. The easternmost sediments at the Aerojet site are about 60 ft thick while at its western boundary, (a distance of six miles) the sediments are nearly 2,000 ft thick. **Table 4-1** presents the site stratigraphy beginning from youngest to oldest geologic formations. A geologic cross section across the Aerojet facility is provided on **Figure 4-5**.

The single most dominant surface features at the Aerojet facility are the dredge tailings that cover approximately 80 percent of the land surface (see inset photo in **Figure 4-5**). The Aerojet facility and surrounding areas have been subjected to historic gold dredging operations beginning in the early 1900s and continuing into the 1960s. The fluvial gold-bearing sediments of the Laguna Formation were the target for the dredges, and areas within the site have been dredged to depths of up to 100 ft (from ground surface). As a consequence of this dredging, the Aerojet site has become a significant groundwater recharge zone for the underlying groundwater bearing zones.

The Eastern OU conceptual hydrogeologic model is presented in **Figure 4-6**. The model was developed from the bottom up, considering the depositional order of geologic formations, erosion of units at the top of geologic formations, and correlation of permeable and less permeable units within the geologic formation using both geologic logs and electrical conductivity logs. The model focuses on continuity of water-bearing layers necessary for tracking of chemical plumes and potential residual products across large distances and multiple layers.

Hydrostratigraphic layers identified in the Eastern OU model include Layers Q (Quaternary sediments), L (Tertiary Laguna Formation), M (Tertiary Mehrten Formation), VS (Tertiary Valley Springs Formation), and I (Tertiary Ione Formation). For brevity, on Layers Q, L and M are described below, as Layers VS and I are not pertinent to this demonstration.

Layer Q is composed of unconsolidated quaternary fluvial sediments and heterogeneous dredge tailings and is typically dry. Layer Q unconformably overlays Layers L and M, creating multiple local perched water-bearing layers, and a laterally discontinuous path for chemicals migrating down to the more continuous layers of the upper Mehrten Formation.

Layer L is relatively thin and is composed of fine-grained fluvial sands intermixed with clays, silts, and pea gravels of the Laguna Formation. Layer L is typically absent due to historic dredging activities and generally occurs east of the liquid rocket test area (LRTA).

Layer M is composed of multiple sublayers of coarse-grained fluvial black sands, variegated gravels, and interbedded clays, tuffs, and breccia of the Mehrten Formation and typically contains the first waterbearing sublayer encountered across the facility. Sublayer M1 may be absent due to historic dredging activities. The majority of the sublayers are present under Area 46 and the southern portion of the LRTA, and two to three sublayers in the northern portion of the LRTA. The Mehrten Formation contains the most productive aquifers underlying the Aerojet site and serves as the principal source of water for private and public water supply wells in the area. The majority of the chemicals released to groundwater are found in the Mehrten Formation.

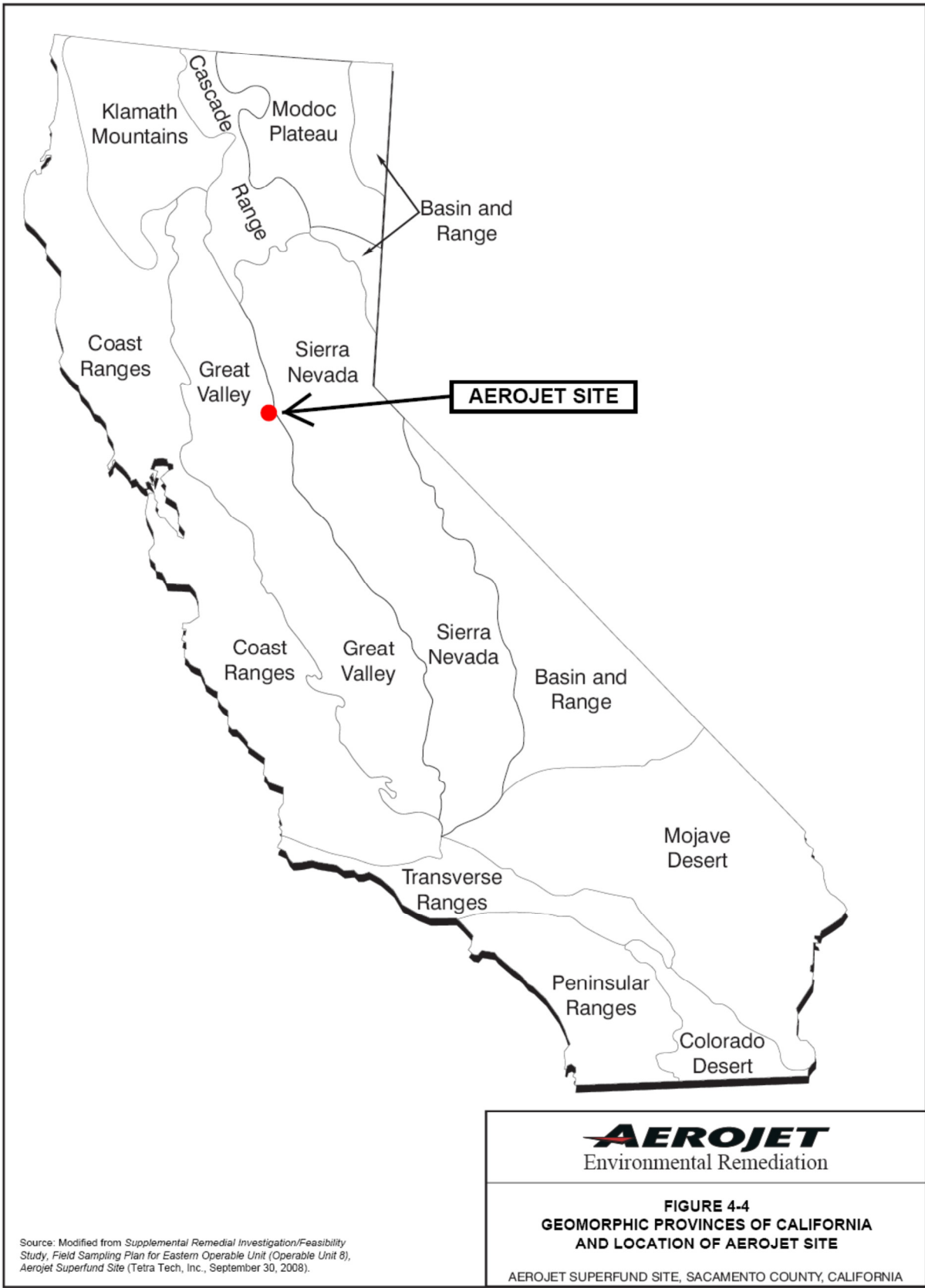
Groundwater flow direction is controlled by a local bedrock high, oriented east to west across the middle of the facility from the LRTA to the Central Disposal Area. Locally, a trough in the bedrock controls groundwater flow in the northern portion of the LRTA, toward Alder Creek. Successive deposition of the Ione, Valley Springs, Mehrten, and Laguna Formations draped thin sediments over the bedrock high and thick layers of sediment in the deep troughs north and south of the facility. Groundwater flow is radial from the center of the bedrock high to the north, west, and south, becoming more westerly with depth and distance from the bedrock high. First groundwater is typically encountered at a depth of 20 ft in the far eastern portion of the facility and 105 ft in the western portion of the facility. However, substantial dewatering and lowering of first water can occur near extraction well fields. Discontinuous lenses of shallow perched groundwater are commonly found across the Aerojet facility. Perched groundwater is most often encountered within dredge tailings (Layer Q) at depths ranging from 10 to 75 ft. Perched groundwater is affected by seasonal recharge and periods of drought, commonly disappearing during long drought periods and rebounding quickly when normal rainfall patterns return.

A hydrostratigraphic cross section through the southern portion of the proposed demonstration area is presented in **Figure 4-7**. A potentiometric surface map for the Mehrten Formation hydrostratigraphic layer M4 (the layer where the demonstration wells were screened) is presented in **Figure 4-8**. Groundwater elevations in Layers Q, M1 through M10, VS, and I demonstrates that there is substantial hydraulic communication between the layers with a vertical downward hydraulic potential. In general, water-bearing layers within the Valley Springs Formation and Ione Formation (west of LRTA) are confined and exhibit a vertical upward hydraulic potential. Reported hydraulic conductivities for the various hydrostratigraphic layers range from 1 to 350 ft/day, with an average of about 70 ft/day (Central Valley, 2005). Hydraulic gradients at the site range from 0.005 to 0.02. As detailed in **Section 5.2**, slug testing performed by CB&I on three monitoring wells in February 2011 indicated hydraulic conductivities ranging from 0.18 to 5.2 ft/day.

The geology of the Eastern OU consists of permeable sand and gravel which is well suited for the biosparging technology proposed for this ESTCP demonstration. Clay and silt interbeds are also present in many locations, but these were not expected to be a significant impediment to the project, and may in fact have aided in keeping injected oxygen and propane confined within the targeted treatment zone. During the site investigation work (**Section 5.2**) each boring was logged to evaluate the local occurrence of these layers within the proposed TPA. Screen intervals and specific locations for gas injection and groundwater monitoring wells were subsequently designed based on site-specific geology.

**Table 4-1. General Site Stratigraphy.**

| <b>Formation Name</b>   | <b>Age</b>                    | <b>Thickness (ft)</b> | <b>Characteristics</b>  |
|---|-------------------------------|-----------------------|---|
| Dredged Tailings and Undifferentiated Alluvial and Fluvial Deposits | Pleistocene to Recent         | 0-100 ft              | Dredge Tailings are unconsolidated heterogeneous mixture of sand, silt, clay and gravels composed primarily of materials derived from the Laguna and Mehrten Formations. Undifferentiated fluvial and alluvial deposits are unconsolidated clay, silt, sand and gravel. May contain discontinuous zones of perched groundwater.   |
| Laguna Formation  | Tertiary Pliocene-Pleistocene | 100-200 ft            | Laguna Formation is encountered at surface to 800 ft from the eastern edge to the western portion of the facility. However, the majority of the formation has been removed by river erosion and dredging activities. Fluvial sediments derived mainly from silica-rich granitic rocks. Composed of silica-rich sands, gravels intermixed with clays and silts. High yield aquifers are found in the Laguna. |
| Mehrten Formation   | Tertiary Miocene-Pliocene     | 100-300 ft            | Mehrten Formation encountered at surface on the eastern edge of the facility and down to 110 ft in the western portion of the facility. Fluvial volcanoclastic sediments composed of black sands, gravels and interbedded clays. This Formation contains the deepest fresh water aquifer.   |
| Valley Springs Formation  | Tertiary Oligocene-Miocene    | 75-300 ft             | Valley Springs Formation encountered near surface on the eastern edge of the facility and down to 435 ft in the western portion of the facility. Composed of volcanoclastic ash, tuff, quartz sand, pebble conglomerates and clay beds. Generally low water yielding brackish to freshwater aquifer.  |
| Ione Formation  | Tertiary Middle Eocene        | 100-400 ft            | Ione Formation encountered at surface on the eastern edge of the facility and down to 495 ft in the western portion of the facility. Composed of marine or transitional quartz sandstone and thick beds of clay.  |
| Chico Formation   | Cretaceous                    | 200-400 ft            | Chico Formation not encountered on the facility. Composed of marine sandstone and shale with small amounts of saline water.   |
| Salt Springs Slate and Gopher Hill Volcanics (Basement Rocks)       | Jurassic                      | unknown               | Encountered at surface on the eastern edge of the facility and down to 600 ft in the central portion and about 1,800 ft in the western portion of the facility. Primarily metamorphic dominated by slates and meta-volcanic rocks.  |



SR10124258 FIGURE 2-1 9/15/08 ah

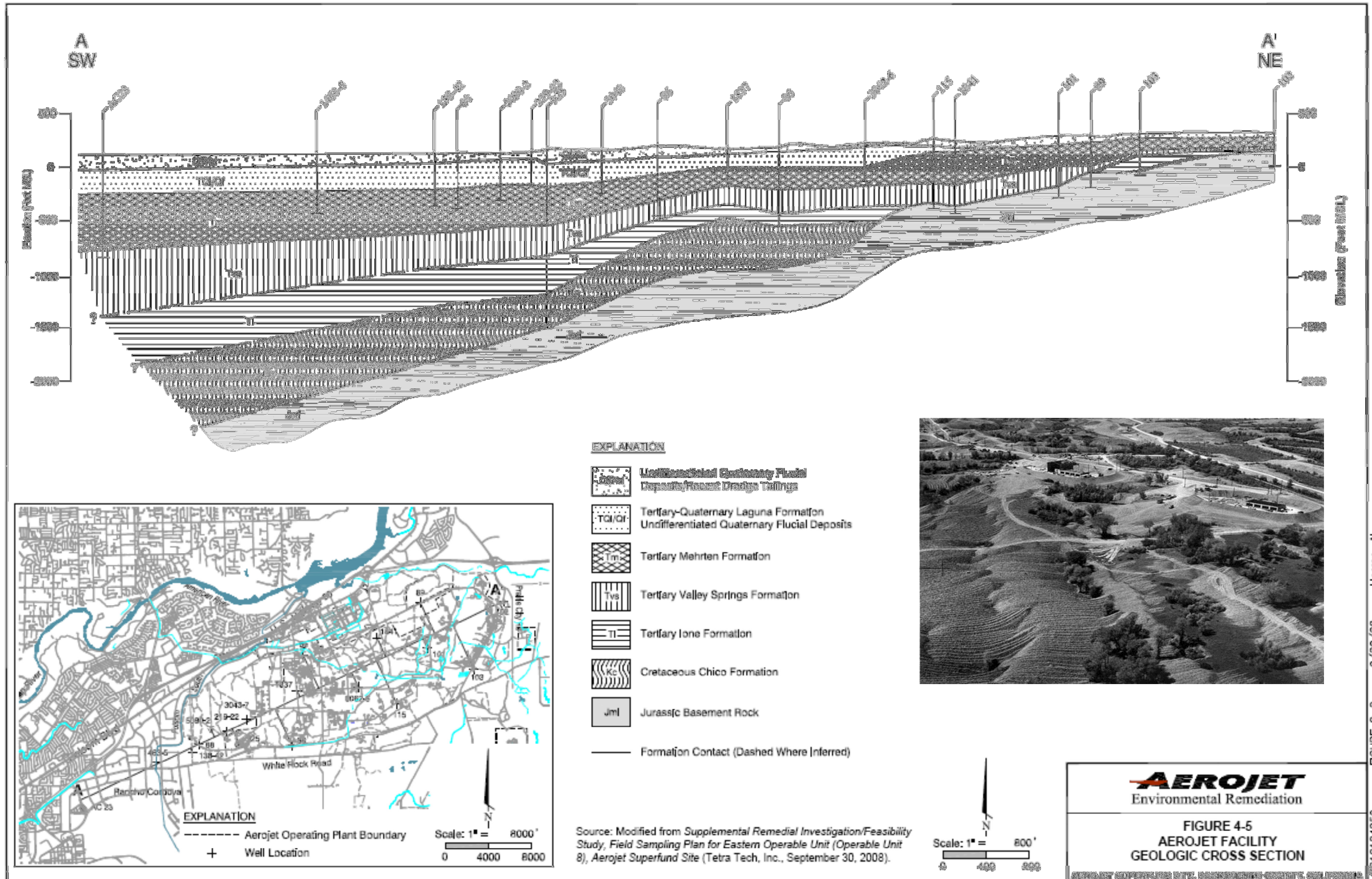
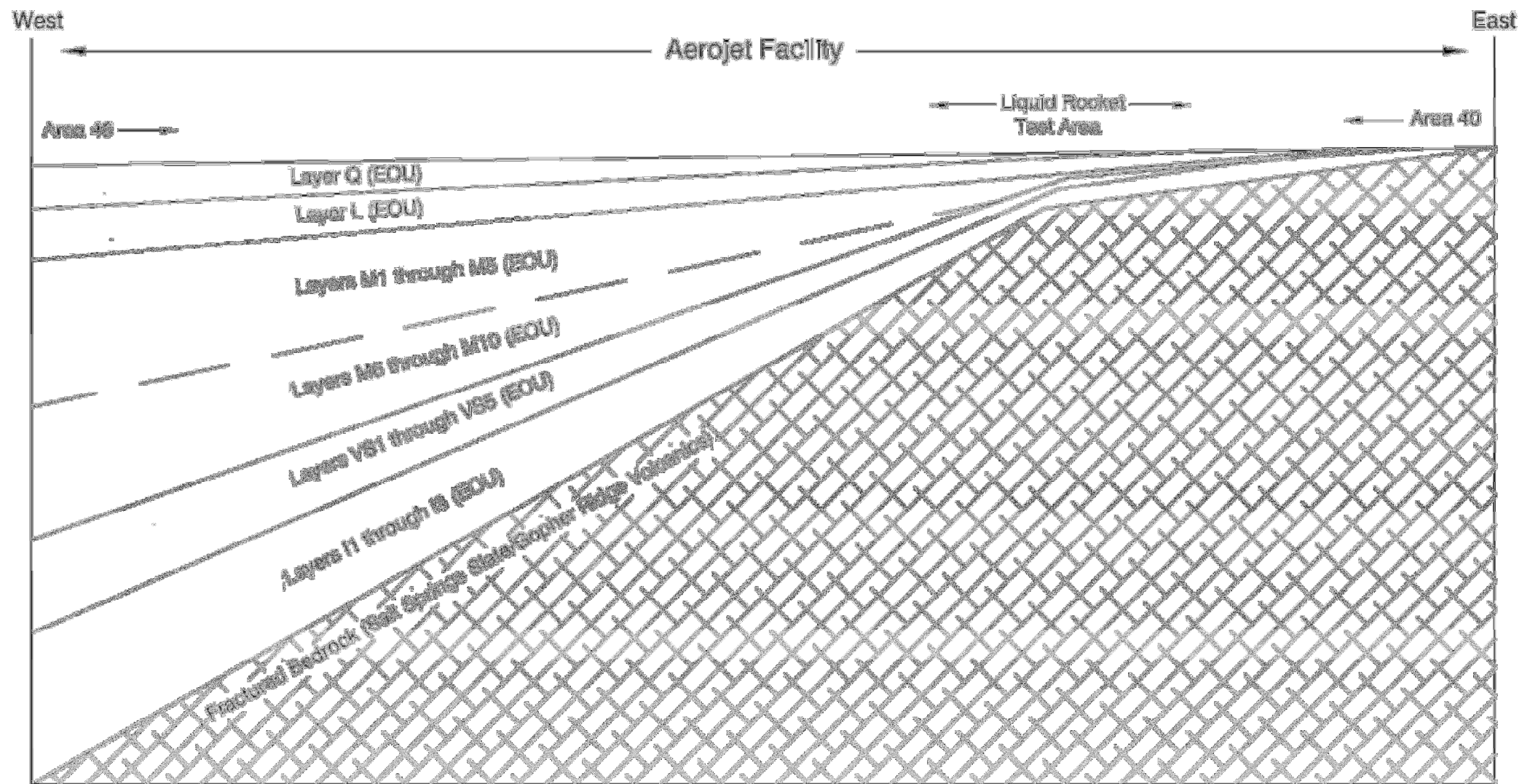


FIGURE 2-2 9/29/08 Herron, AI





Source: Modified from *Supplemental Remedial Investigation/Feasibility Study, Field Sampling Plan for Eastern Operable Unit (Operable Unit 6), Aerojet Superfund Site* (Tetra Tech, Inc., September 30, 2003).

Not to Scale

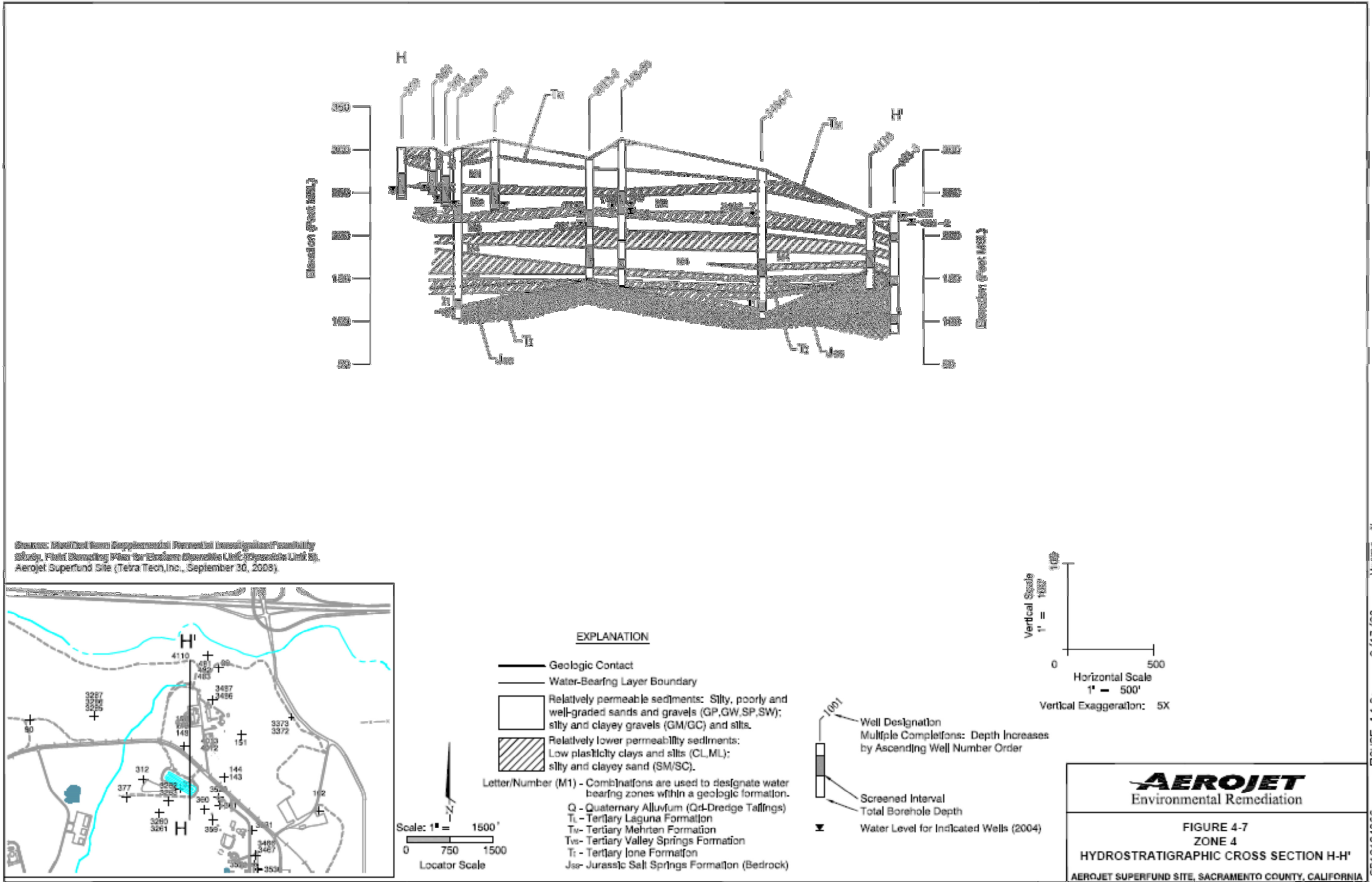
**AEROJET**  
Environmental Remediation

FIGURE 4-6  
EASTERN OPERABLE UNIT CONCEPTUAL  
HYDROGEOLOGIC MODEL

AEROJET SUPERFUND SITE, SACRAMENTO COUNTY, CALIFORNIA

FIGURE 2-4 9/17/08 Herron, AI

SR10124303



Source: Modified from Supplemental Remedial Investigation Feasibility Study, Final Remedial Plan for Eastern Operable Unit, Operable Unit 2, Aerojet Superfund Site (Tetra Tech, Inc., September 30, 2008).

SR10124266 9/17/08 Herwin, A1 FIGURE 4.1.2c

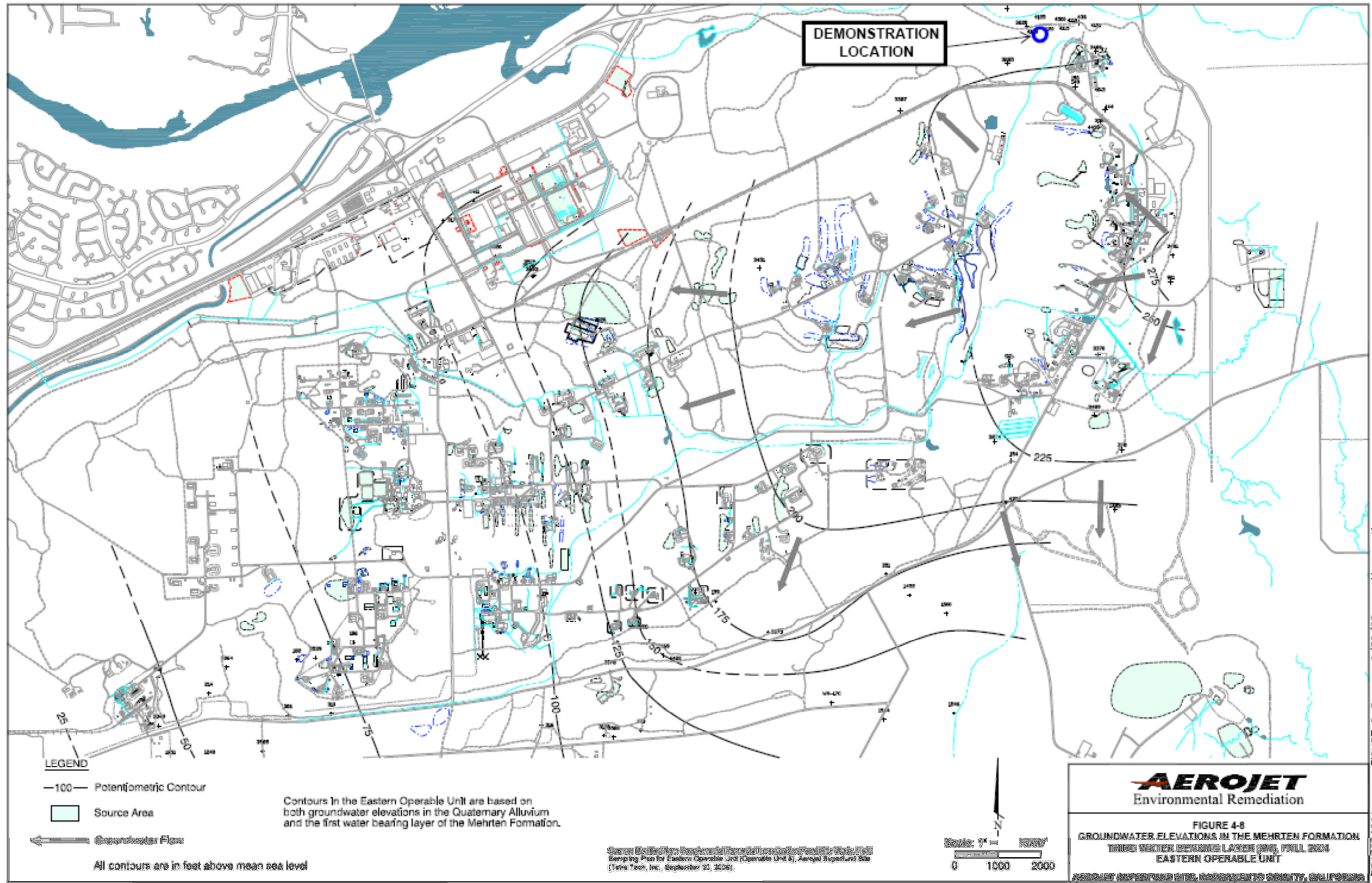
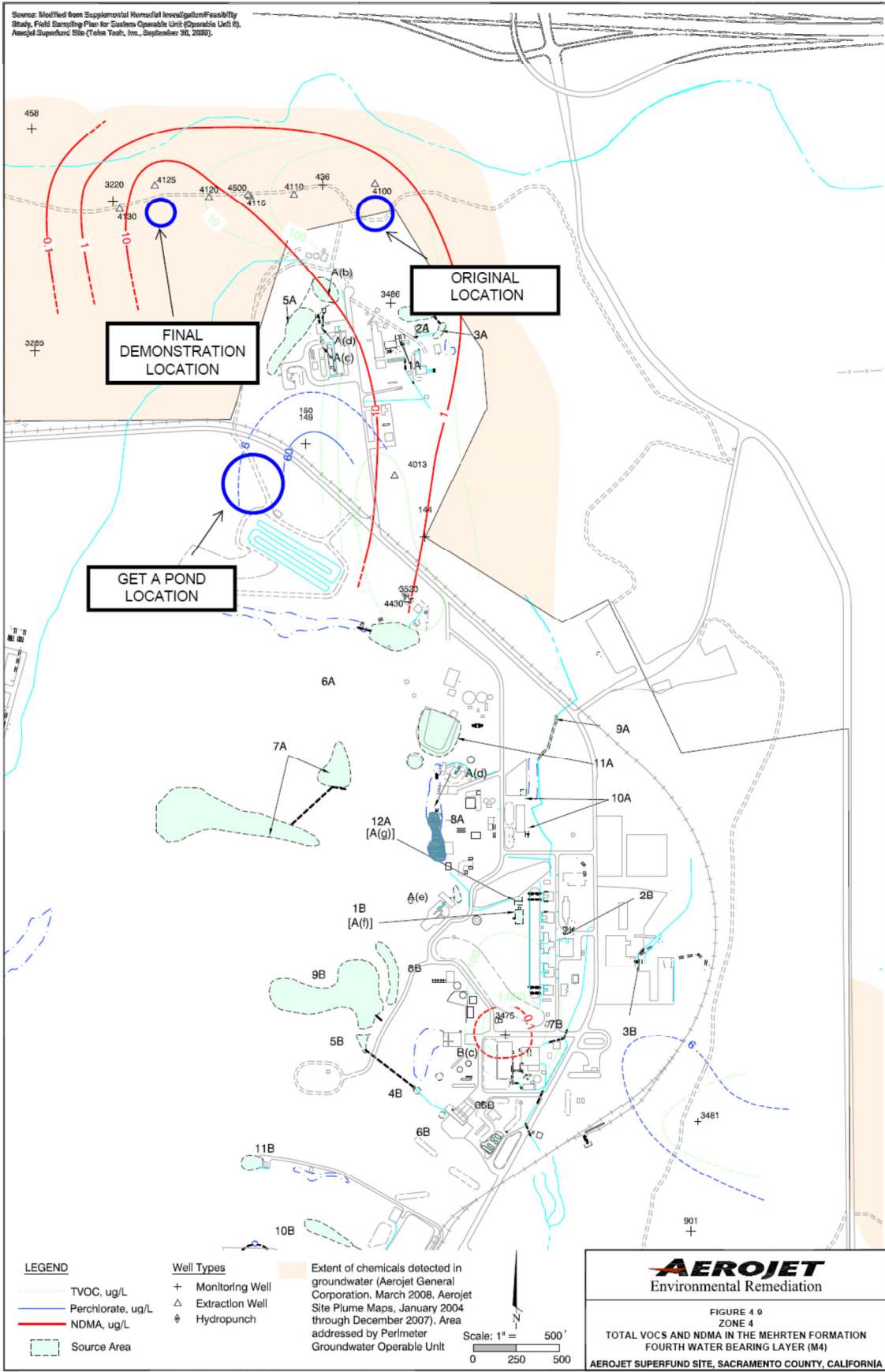


FIGURE 2-5a 9/30/08 Herron, AI ER10714261

### 4.3 CONTAMINANT DISTRIBUTION

A map of total VOCs and NDMA groundwater concentrations within the M4 hydrostratigraphic unit in Zone 4 is provided in **Figure 4-9**. The TPA area selected near EW 4125 and the other areas evaluated (near the former GET A Pond and EW 4100) are shown on the figure. Existing site data indicated that NDMA concentrations in each of these potential areas should be greater than 1 µg/L, while total VOC concentrations could be variable. However, VOC concentrations were expected to be less than 200 µg/L in both the GET A Pond area and near EW 4125. NDMA also exists in the M2 layer in this general area. However, this layer had lower NDMA concentrations based on initial site assessment work, and may not have been sufficiently saturated to serve as an effective water-bearing zone for the demonstration. Site characterization activities detailed in **Section 5.2** provided the necessary contaminant distribution information required to select the location and depth of the TPA well network.



## 5.0 TEST DESIGN

The following subsections provide detailed description of the system design and testing that were conducted to address the performance objectives described in **Section 3.0**.

### 5.1 CONCEPTUAL EXPERIMENTAL DESIGN

During this ESTCP demonstration, propane and oxygen (air) were added to an NDMA-contaminated aquifer to stimulate indigenous propanotrophs to biodegrade the nitrosamine. The key objective was to evenly distribute propane and oxygen gas throughout the desired treatment area. This was accomplished using a biosparging approach (see **Figure 2-1**). This approach is mature, cost effective, and can be safely applied in a number of different configurations based on site conditions. A well network was installed for this purpose, that included a series of air and propane biosparging wells, a series of treatment zone groundwater monitoring wells to evaluate the performance of propane and oxygen addition, one side-gradient monitoring well installed in a zone outside the influence of the sparge wells, and two downgradient monitoring wells. The system performance was evaluated by measuring propane, oxygen, and NDMA concentrations before and after propane and oxygen biosparging in all of the installed monitoring wells. Geochemical parameters and propanotrophic bacteria also were measured.

Design of the *in situ* propane biosparging system required detailed site-specific knowledge of the contaminant distribution, aquifer lithology and hydrology and microbiology. Specific system parameters directly influenced by these factors included amendment selection and addition rates, and the spacing and screen intervals of the biosparge and monitoring wells. All available site characterization data was reviewed prior to selecting the location of the demonstration (see previous summary in **Section 4**). However, additional local characterization of the selected demonstration TPA was required to facilitate system design. The activities described within this section were conducted in order to attain the needed site-specific information required for final system design. Specific activities included laboratory microcosms and column experiments to evaluate biodegradation kinetics, monitoring well and biosparge well installation, air-injection testing to determine biosparging radius of influence, supplemental groundwater investigation to confirm contaminant concentrations and delineate the dissolved contaminant plume, and passive flux meter testing to confirm groundwater flow rate.

### 5.2 BASELINE CHARACTERIZATION

Prior to site selection, CB&I reviewed existing site investigation documents and all available hydrogeologic, contaminant concentration, and geochemical data for the Aerojet Site. While these data were helpful in the selection of three potential TPAs in two different regions (as discussed in **Section 4.1**), additional data were required to effectively design the field demonstration. The following subsections describe baseline characterization activities that were performed.

In February, 2011, after determining that the original TPA near EW 4100 was unsuitable for the demonstration (see **Figure 4-9**), CB&I performed site characterization activities in Zone 4 using existing site monitoring wells that included:

- Groundwater elevation data collection,
- Groundwater sampling, and
- Hydrogeologic testing (i.e. slug tests).

Results of these activities led to the selection of the two potential locations for the demonstration (the Alder Creek Area near extraction well EW 4125, and the former GET A Pond Area; **Figure 4-9**). Additional site characterization activities conducted in each of these two locations in March and April, 2011 included:

- Continuous soil core collection,
- Discrete groundwater sample collection,
- Monitoring and biosparging well installations, and
- Groundwater sampling of the new monitoring and biosparging wells.

Results of these activities were used to select the Alder Creek Area south of EW 4125 as the TPA. Additional site characterization activities conducted in this area included:

- Air sparge testing to determine radius of influence of biosparging wells and connectivity of the newly installed biosparging and monitoring wells in the TPA,
- Passive flux meter (PFM) testing, to verify groundwater velocity in the TPA, and
- Measurement of groundwater elevation in all new wells, and determination of gradient.

The results of these baseline activities are provided in the subsequent sections.

### **5.2.1 Groundwater Elevation Data Collection**

Groundwater elevation measurements were collected at several Zone 4 monitoring wells in February 2011 using an electronic water level indicator. Measurements were obtained from the surveyed top-of-casing and recorded to the nearest 0.01-ft. Groundwater elevation data were used to establish current potentiometric surface elevations for the M2, M3, and M4 hydrostratigraphic layers at various locations, and to determine the extent of saturation within the M2 layer (the shallowest water bearing zone in this portion of the site).

Groundwater elevation data collected in the vicinity of the former GET A Pond indicated that the M2 layer was only partially saturated, with saturated thicknesses ranging between approximately 2 and 8 ft. It should be noted that water table elevations at the site were at recent historic lows. These data, along with data collected during continuous soil core collection (**Section 5.2.4**), indicated that the M2 layer in this area was not a viable option for performing the demonstration. Hydrostratigraphic layers M3 and M4 were determined to be completely saturated in this area.

Groundwater elevation data collected in the Alder Creek Area indicated that hydrostratigraphic layers M2, M3, and M4 were all completely saturated, with depths to water ranging between 3 and 8 ft below ground surface. Historic groundwater elevation data collected from well clusters in this area indicated that confining or semi-confining conditions exist within the M3 or M4 layers.

## 5.2.2 Groundwater Sampling of Existing Monitoring Wells

Groundwater samples were collected from three monitoring wells (312, 331, and 3262) in the former GET A Pond area on February 14, 2011. The data collected from these samples, along with existing site data, were used to assist in determining potential TPA locations. Samples were analyzed for VOCs, reduced gases, anions (including nitrate and sulfate), and NDMA. These data are summarized in **Table 5-1**.

**Table 5-1. Geochemical and Contaminant Data from Wells 312, 331, and 3262.**

| Well ID                                      | 312   | 331   | 3262  |
|--|-------|-------|-------|
| <b>NDMA</b>                                  | ng/L  | ng/L  | ng/L  |
| NDMA   | 86    | 390   | 24    |
| <b>VOCs</b>                                  | µg/L  | µg/L  | µg/L  |
| <b>bromomethane</b>                          | 8.5   | 9.1   | 9.9   |
| <b>trichlorotrifluoromethane (Freon 113)</b> | <5    | 14.1  | <5    |
| <b>dichlorotrifluoromethane</b>              | <5    | 0.6   | <5    |
| <b>trichloroethene (TCE)</b>                 | <5    | 2.1   | <5    |
| <b>REDUCED GASES (GC)</b>                    | µg/L  | µg/L  | µg/L  |
| <b>Methane</b>                               | 980   | 0.92  | 182   |
| <b>Ethane</b>                                | 12.0  | <4    | 1.26  |
| <b>Ethene</b>                                | <5    | <5    | <5    |
| <b>ANIONS</b>                                | mg/L  | mg/L  | mg/L  |
| Chloride                                     | 11.9  | 19.3  | 5.88  |
| Sulfate as SO <sub>4</sub>                   | 17.5  | 23.5  | 91.5  |
| Nitrate as N                                 | <0.2  | 9.41  | <0.2  |
| O-Phosphate as P                             | <0.2  | <0.2  | <0.2  |
| <b>FIELD PARAMETERS</b>                      |       |       |       |
| temp (°C)                                    | 15.5  | 17.8  | 16.0  |
| DO (mg/L)                                    | 1.21  | 0.60  | 0.60  |
| ORP (mV)                                     | -121  | 170   | -31   |
| conductance (µS/cm)                          | 202.1 | 291.4 | 318.7 |
| DTW (ft-btoc)                                | 71.44 | 81.56 | 69.83 |
| <b>GROUNDWATER CHEMISTRY</b>                 | SU    | SU    | SU    |
| pH   | 6.40  | 7.18  | 6.85  |



Sampling was performed by CB&I personnel utilizing low-flow purging methods in accordance with USEPA Low Flow Purging and Sampling guidance (Puls and Barcelona, 1996). Samples were obtained using a submersible variable speed pump (Grundfos RediFlo 2) and dedicated Teflon tubing. A multi-parameter YSI field meter with a flow-through cell was used to collect measurement of field geochemical parameters (pH, ORP, temperature, specific conductivity, and DO). Samples were packed on ice and shipped overnight delivery. With the exception of NDMA, groundwater samples were analyzed by CB&I's analytical laboratory in Lawrenceville, New Jersey. NDMA samples were analyzed by Weck Laboratories, Inc., in City of Industry, California.

As summarized in **Table 5-1**, NDMA concentrations in these three wells (screened within the M2 layer) ranged from 24 ng/L to 390 ng/L. Total VOCs in these wells ranged from approximately 9 µg/L to 26 µg/L. There were no monitoring wells screened within the M3 and M4 layers in the former GET A Pond Area at the time of sample collection. However, based on other contaminant concentration data in Zone 4, it was anticipated that NDMA (and potentially VOC) concentrations would be higher in the M3 and M4 layers in this area. Groundwater concentrations in these layers were determined during site characterization activities near GET A Pond as detailed below in **Section 5.2.5**.

Existing monitoring wells in the Alder Creek Area were not sampled, as recent sampling data (from both monitoring and extraction wells) indicated that NDMA contaminant concentrations range between 1 µg/L and ~ 20 µg/L in the M2 through M4 layers in this area. These data also indicated that total VOCs were below 10 µg/L.

### **5.2.3 Slug Testing at Existing Monitoring Wells near GET A Pond**

Rising and falling head slug tests were performed on February 11, 2011 at monitoring well 3262 in the former GET A Pond Area (**Figures 4-3 and 4-9**). Wells 312 and 331, also located in this area, did not have a sufficient water column to perform slug testing. Slug tests were performed to estimate the hydraulic conductivity in the M2 hydrostratigraphic layer at this location. This information, along with estimated groundwater gradients, was used to estimate linear groundwater velocity.

Slug test data were analyzed using AQTESOLV Pro software. The hydraulic conductivity was estimated at 0.18 ft/day, and the linear groundwater velocity was estimated at 0.009 ft/day. These values are on the low end of the scale, compared to existing site data. It should be noted that this well was constructed with slotted steel screen and installed ~ 25 years ago. Remnants of what appeared to be oxidized steel were observed on the top of the slug during testing at this location. Therefore, the hydraulic conductivity value and estimated linear groundwater velocity may be artificially low due to reduced groundwater flow through the well screens.

### **5.2.4 Continuous Soil Core Collection**

In April 2011, one continuous soil core was collected at each of the two potential demonstration areas (**Figures 4-3 and 4-9**). The primary purpose of this activity was to improve delineation of the stratigraphy in each of these locations. Locating of all underground utilities was arranged with appropriate Aerojet facility personnel and local utility companies prior to initiating drilling

activities. Additionally, each borehole was first advanced to a depth of approximately 5 ft bgs by air-knife to clear for underground utilities. Both boreholes were advanced using roto-sonic drilling equipment. The boreholes in the former GET A Pond Area (DB-1) and in the Alder Creek Area (DB-2) were advanced to 118 and 81 ft bgs, respectively. The drilling tools included a 4-inch diameter sonic core barrel followed by a flush threaded 6-inch temporary casing. During drilling, recovered soil cores were screened for VOCs using a photo-ionization detector (PID) and logged by a CB&I geologist.

Information obtained from this investigation was used to identify the higher permeability hydrostratigraphic layers (i.e., M2, M3 and M4), and the lower permeability layers that separate them (**Figure 4-7**) at each of the potential demonstration locations. Stratigraphic data collected were used to identify zones for discrete groundwater sampling (**Section 5.2.5**). The boring logs indicated that the zones of higher and lower permeability are not as homogeneous as those depicted in cross section H-H' (**Figure 4-7**). Rather than having higher permeability layers that were continuous and between 5 and 25 ft in thickness, they tended to be approximately 1 to 6 ft in thickness and interbedded with lower permeability layers. Therefore, identifying what might be considered the M2, M3, and M4 layers was not straightforward. Thus, the thickest higher permeability layers (>4 ft in thickness) were targeted as groundwater sampling intervals (**Section 5.2.5**) and potential demonstration zones.

It should be noted that the depth to groundwater (approximately 75 ft) and the difficult conditions (cobbles, running sands, and extremely heterogeneous subsurface geology) made drilling in the former GET A Area extremely difficult. Conversely, a shallow depth to groundwater (approximately 5 ft bgs) and a somewhat less heterogeneous subsurface geology made drilling in the Alder Creek area much easier.

### **5.2.5 Discrete Groundwater Sample Collection and Selection of Treatment Depth**

A total of four discrete groundwater samples were collected at two soil boring locations to further evaluate vertical groundwater contaminant distribution within the two potential demonstration areas. One discrete sample was collected during the drilling of continuous soil coring location DB-1 (former GET A Area), and three discrete groundwater samples were collected from soil boring DB-3 (Alder Creek Area). While one discrete groundwater sample was collected during the advancement of borehole DB-1, it was decided that it would be more advantageous to use lithologic information gathered during the drilling of DB-2 (**Section 5.2.4**) to identify intervals for discrete groundwater sampling during the advancement of boring DB-3 (located approximately 10 ft away).

The discrete groundwater sample interval at boring DB-1 was determined by advancing the 4-inch core barrel approximately 10 ft ahead of the 6-inch temporary casing, extracting the 4-inch core barrel, and retrieving a soil core sample. The recovered soil core for each 10 ft interval was logged by a CB&I geologist to determine the lithology and locate high permeability (water bearing) and low permeability zones. If a sample zone was not identified, the 6-inch temporary casing was advanced to the bottom depth of the core sample, and the process repeated. When a sufficiently thick water bearing zone was observed (>4 ft), the 6-inch temporary casing was advanced to the top of that zone, to isolate it from any water bearing zones above. The predetermined discrete groundwater sampling intervals at boring DB-3 were isolated in the same

way, by advancing the 4-inch core barrel to the bottom of the sample interval, and the 6-inch temporary casing to the top of the sample interval. Groundwater samples in both borings were collected by removing the 4-inch core barrel and lowering a 5 ft section of dedicated 2-inch inner diameter (ID) pre-packed well screen and 2-inch ID PVC casing beyond the temporary casing, and into the sample interval. The surrounding formation was either allowed to collapse around the screen, or filter pack sand was installed to approximately 1 ft above the top of the temporary well screen. A submersible sampling pump with dedicated tubing was then lowered to the middle of the screen interval, and groundwater was pumped until the discharge water was relatively free of sediment prior to samples being collected.

Samples for NDMA, VOCs, and anions were then collected for laboratory analysis. Field parameters (pH, specific conductivity, ORP, and DO) were also measured using a multi-parameter YSI field meter. Analytical samples collected were packed on ice, shipped overnight, and analyzed by CB&I's analytical laboratory in Lawrenceville, New Jersey on a 24-hr turnaround. All non-dedicated sampling equipment was decontaminated between samples.

Discrete interval groundwater sampling depths and analytical results are summarized in **Table 5-2**. Sampling results indicated 274 µg/L total VOCs (primarily TCE and Freon 113) in the discrete sample collected from the former GET A Pond Area (DB-1), and no detected VOCs in the samples collected from the Alder Creek Area (DB-3). Results indicated the presence of NDMA in all samples, ranging from 500 ng/L to 20,000 ng/L. At the Alder Creek Area site, which was selected as the demonstration area, NDMA concentrations increased with depth, ranging from 500 ng/L in a shallow conductive zone (20' to 25' bgs; likely M1) to 20,000 ng/L in a conductive zone just above bedrock at the site (52' to 72' bgs; likely M4 interval). Based upon data collected from the initial borings in this area (DB-2, DB-3), it was determined that the additional site characterization activities and the remedial demonstration would focus on the deepest conductive zone encountered during site characterization activities performed in the Alder Creek Area (presumed M4 layer in **Figure 4-7**), which consisted of well graded sand and/or well graded gravel with sand. This confined region of the aquifer was conductive, reasonably continuous (although the depth and thickness were somewhat variable in the plot), and had the highest apparent NDMA concentrations. See **Section 5.2.6** for further details on well installation.

**Table 5-2. Geochemical and Contaminant Data from Soil Borings in the Get A Pond Area (DB-1, DB-2, DB-3) and the Alder Creek Area near EW 4125 (DB-3).**

| Well ID                    | DB-1 103' to 108' | DB-3 20' - 25' | DB-3 37-42' | DB-3 52'-72'  |
|----------------------------|-------------------|----------------|-------------|---------------|
| <b>Nitrosamines</b>        | ng/L              | ng/L           | ng/L        | ng/L          |
| NDMA (GC/MS)*              | <b>1300</b>       | <b>500</b>     | <b>3400</b> | <b>20,000</b> |
| <b>VOCS (GC/MS)</b>        | mg/L              | mg/L           | mg/L        | mg/L          |
| Freon-113                  | 234               | <5             | <5          | <5            |
| cis-DCE                    | 5.1               | <5             | <5          | <5            |
| TCE                        | 35                | <5             | <5          | <5            |
| <b>ANIONS</b>              | mg/L              | mg/L           | mg/L        | mg/L          |
| Chloride                   | ND                | <b>2.7</b>     | <b>3.9</b>  | <b>19.2</b>   |
| Sulfate as SO <sub>4</sub> | ND                | <b>5.9</b>     | <b>8.7</b>  | <b>15.5</b>   |
| Nitrate as N               | ND                | <b>0.1</b>     | <b>0.5</b>  | <b>2.2</b>    |
| Phosphate as P             | ND                | <0.2           | <0.2        | <0.2          |

NDMA Analysis conducted by GC/MS in CB&I Lawrenceville lab.

### 5.2.6 Monitoring and Biosparging Well Installations

A total of five monitoring wells and one biosparging well were installed during site characterization activities. The first monitoring well (DBMW-1) was constructed in continuous soil core boring DB-1, in the former GET A Pond Area, and was not used during the demonstration. Four monitoring wells (PMW-1 through PMW-4) and one biosparging well (BSW-1) were installed in the Alder Creek Area, as shown on **Figure 3-1**. These wells were used initially for groundwater sampling (**Section 5.2.7**) and subsequently for air sparge testing (**Section 5.2.8**). The four monitoring wells installed in the Alder Creek Area also were used for sparging and/or monitoring during the demonstration. Biosparging well BSW-1, which was installed with 20 feet of screen, was later over-drilled for the installation of biosparging well BW-3, which was constructed with 5 feet of screen, after it was determined that BSW-1 spanned more than one conductive layer (**Section 5.2.8**).

Locating underground utilities was arranged with appropriate Aerojet facility personnel and local utility companies prior to initiating drilling activities. Additionally, each borehole was first advanced to a minimum depth of 5 ft bgs by air-knife to clear for underground utilities. The borehole was then advanced to the final depth using rotosonic drilling equipment. The drilling tools included a 4-inch diameter sonic core barrel followed by a flush threaded 6-inch temporary casing. With the exception of the first 20 to 40 ft at some locations, continuous soil cores were collected to confirm stratigraphy and verify well screen intervals. During drilling, recovered soil cores were screened for VOCs using a photo-ionization detector (PID) and logged by a CB&I geologist. Boring logs are provided in **Appendix C**.

All wells were constructed through the six inch temporary casing. Biosparging and monitoring wells were constructed with flush-threaded, 2 inch diameter, Schedule 40, PVC riser and 0.020-inch slotted PVC well screen. Monitoring well screens were all 5 ft in length, while the first biosparging well screen (BSW-1) was 20 ft in length. The depth of each well and the screen interval were based on the geological data collected from each borehole. The well screen intervals were chosen to intercept the deep sand & gravel layer observed in the initial site borings (see **Section 5.2.5**), which was assumed to be the M4 layer described in the Aerojet site investigation (e.g., see **Figure 4-7**). The well logs are provided in **Appendix C**, and the screen intervals for all wells are provided later in the report (**Table 5-5**).

The filter pack for each monitoring well consisted of #3 sand, extending to approximately 3 ft above the top of well screen. A minimum 3-ft bentonite seal was placed above the filter pack. The remaining annular space was filled with cement-bentonite grout (no more than five percent bentonite by weight) emplaced to within 2 ft of the surface via Tremie pipe. Each well was completed with either a flushmount or locking steel well casing protector installed in a 24 inch by 24 inch concrete pad at the ground surface.

All drilling and sampling tools were thoroughly decontaminated between boreholes. Drilling rig and tool decontamination was performed using a pressure washer on a mobile decontamination pad provided by the drillers. Decontamination fluids were pumped to an on-site temporary storage tank, and disposed of at an on-site groundwater treatment facility. Soil cuttings were spread evenly on the ground adjacent to each drilling location.

Well development was accomplished by pumping the groundwater until the water was clear and sediment free to the fullest extent practical. Wells were developed using a surge block, bailer, and submersible pump. Water was not added to the well to aid in development. The pump, hose, bailer and cable were decontaminated between locations. Well development and decontamination fluids were pumped to an on-site temporary storage tank, and disposed of at an on-site groundwater treatment facility.

Each well was surveyed by a licensed surveyor to determine its horizontal location to within  $\pm 1$  ft, and the elevation of the top of the inner PVC well casing to a  $\pm 0.01$ -ft precision.

### **5.2.7 Groundwater Sampling of Monitoring and Biosparging Wells**

At the end of well development, screening level groundwater samples were collected from the five newly installed monitoring wells (DBMW-1 and PMW-1 through PMW-4) and the biosparging well (BSW-1).

Samples were obtained using the same submersible variable speed pump used for well development and dedicated tubing. A multi-parameter YSI field meter with a flow-through cell was used to collect measurement of field geochemical parameters (pH, ORP, temperature,

specific conductivity, and DO). Once the development water being purged was clear, and field parameters stabilized, the flow rate of the submersible pump was reduced, and groundwater samples collected. Samples were collected for NDMA, VOCs, anions (including nitrate and sulfate), and dissolved iron and manganese. Samples were packed on ice and shipped overnight delivery. VOC and anion samples were analyzed by CB&I's analytical laboratory in Lawrenceville, NJ, NDMA samples were analyzed by Weck Laboratories, Inc., in City of Industry, CA, and dissolved iron and manganese samples were analyzed by Chemtech Laboratories, Mountainside, NJ.

Results of the screening level data for the six newly installed wells are summarized in **Table 5-3**. As with the discrete groundwater samples (**Section 5.2.5**), sampling results from the wells indicated the presence of VOCs in the former GET A Pond Area and no detected VOCs in the Alder Creek Area wells. Total VOCs in well DBMW-1 were > 2,000 µg/L in the screened interval, with 55.5 µg/L TCE and 1,987 µg/L Freon 113. Results also indicated significantly higher NDMA concentrations (15,000 to 21,000 ng/L) in the five Alder Creek Area wells, compared to 240 ng/L in the former GET A Pond Area well. As discussed in **Section 5.2**, these data, along with the stratigraphic data collected, indicated that the Alder Creek Area location was more favorable than the former GET A Pond Area for the TPA.

**Table 5-3. Geochemical and Contaminant Data from Wells Installed in the GET A Pond Area (DBMW-1) and the Alder Creek Area Near EW 4125 (BSW-1, PMW1-4).**

| Well ID                                  | BSW-1 | PMW-1 | PMW-2 | PMW-3  | PMW-4  | DBMW-1 |
|--|-------|-------|-------|--------|--------|--------|
| <b>NDMA</b>                              | ng/L  | ng/L  | ng/L  | ng/L   | ng/L   | ng/L   |
| NDMA                                     | 17000 | 21000 | 15000 | 19000  | 18000  | 240    |
| <b>VOCs</b>                              | µg/L  | µg/L  | µg/L  | µg/L   | µg/L   | µg/L   |
| dichlorodifluoromethane                  | <5    | <5    | <5    | <5     | <5     | 38.8   |
| bromomethane                             | <5    | <5    | <5    | <5     | <5     | 8.04   |
| trichlorotrifluoromethane<br>(Freon 113) | <5    | <5    | <5    | <5     | <5     | 1987   |
| 1,1-dichloroethene                       | <5    | <5    | <5    | <5     | <5     | 15.4   |
| cis-1,2-dichloroethene (DCE)             | <5    | <5    | <5    | <5     | <5     | 6.31   |
| 1,2-dichloroethane                       | <5    | <5    | <5    | <5     | <5     | 5.80   |
| trichloroethene (TCE)                    | <5    | <5    | <5    | <5     | <5     | 55.5   |
| <b>ANIONS</b>                            | mg/L  | mg/L  | mg/L  | mg/L   | mg/L   | mg/L   |
| Chloride                                 | 8.94  | 9.15  | 26.9  | 9.87   | 9.80   | 8.08   |
| Sulfate as SO <sub>4</sub>               | 14.3  | 14.9  | 18.5  | 14.7   | 13.5   | 7.65   |
| Nitrate as N                             | 2.02  | 2.09  | 0.82  | 2.15   | 2.01   | 0.38   |
| O-Phosphate as P                         | <0.2  | <0.2  | <0.2  | <0.2   | <0.2   | <0.2   |
| <b>FIELD PARAMETERS</b>                  |       |       |       |        |        |        |
| temp (°C)                                | 17.23 | 17.14 | 17.46 | 17.79  | 18.75  | 18.75  |
| DO (mg/L)                                | 0.21  | 0.23  | 0.49  | 0.32   | 0.45   | 0.45   |
| ORP (mV)                                 | -94.7 | -70.9 | -80.7 | -251.2 | -181.4 | -181.4 |
| conductance (µS/cm)                      | 284   | 268   | 308   | 293    | 276    | 276    |
| DTW (ft-btoc)                            | 8.90  | 14.10 | 11.90 | 7.02   | 35.62  | 35.62  |
| pH                                       | 6.58  | 6.93  | 7.07  | 6.48   | 8.00   | 8.00   |

### 5.2.8 Sparge Testing

Adequate gas distribution is critical to the success of this biosparging approach for NDMA treatment. The distribution of oxygen and groundwater mounding were initially tested by utilizing the single biosparging well (BSW-1) and four monitoring wells (PMW-1 through PMW-4) to perform gas injection test with air (to supply O<sub>2</sub>) to evaluate the distribution radius. During this test, dissolved O<sub>2</sub> was monitored at the wells as a function of sparging time and gas flow (SCFM) using field meters in each well. The demonstration site has a naturally low concentration of dissolved O<sub>2</sub> (< 1 mg/L) and a relatively low oxidation-reduction potential ORP (~ -100 mV) (**Table 5-3**). The presence of nitrate and sulfate in the local groundwater suggest that conditions are not highly reducing, but merely anoxic. As a result, the gas distribution during testing was evaluated by measuring water levels increases in measured dissolved oxygen (DO) in the monitoring wells installed at ~ 7 ft (PMW-3), 12.5 ft (PMW-1), 14 ft (PMW-2) and 24 ft (PMW-4) from the initial biosparge well (BSW-1; See **Figure 5-1**) with field meters.

The methodology for the gas distribution testing performed on May 5, 2011, was to inject air into the biosparging well at incremental flow rates of approximately 0.5, 1.0, 2.0 and 5.0 standard cubic ft per minute (SCFM) for up to 1 hour at each flow rate. The data collected from the four monitoring wells during gas distribution testing included qualitative descriptions of any observed bubbling (i.e., none, trace, low, moderate, rapid), and any changes in water table elevation, both of which are indicators of sparging radius of influence. DO concentrations were continually measured at monitoring wells PMW-1 and PMW-3 during sparge testing by continually purging groundwater (~200-250 mL/min) from the wells using a dedicated sampling pump. The purged water was passed through a flow-through cell containing a multi-parameter YSI meter. Field parameters (including DO) were recorded approximately every 10-15 minutes during testing. DO concentrations were also collected from monitoring well PMW-2 prior to sparge testing, and near the end of sparge testing using the same procedure. In addition, the breakout and operational air injection pressures were monitored to ensure that the soil overburden pressure was not exceeded, and to provide an accurate measure of the pressure-adjusted gas flow rate. Calibrated YSI field meters were used to measure both DO and ORP during sparge testing.

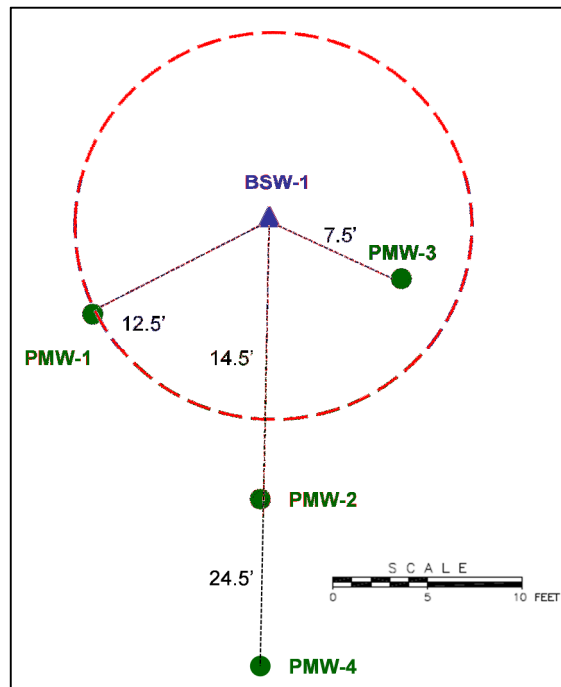
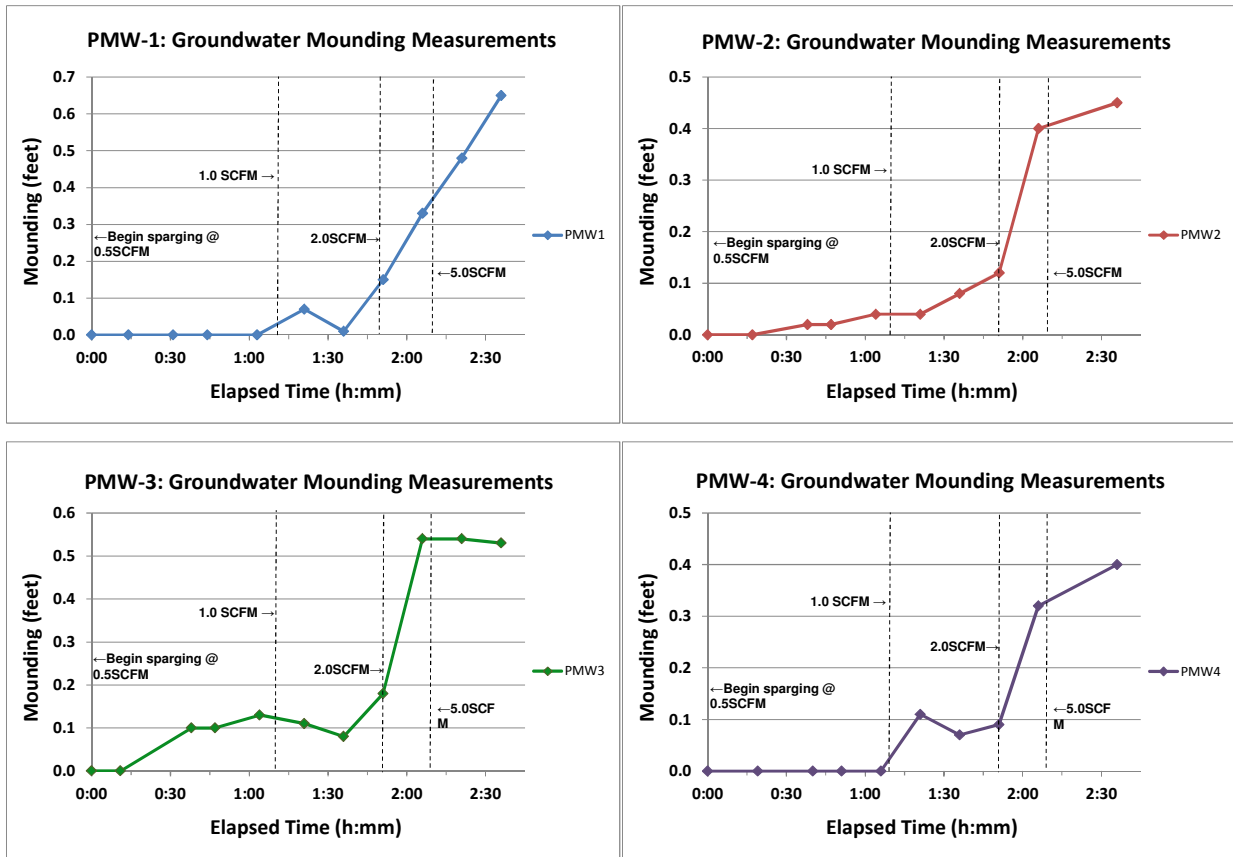
The success criteria for gas distribution for the initial gas injection test was the observation of mounding, bubbling, and/or an increase of at least 0.5 mg/L DO above baseline in the four monitoring locations adjacent to the air injection well within the allotted testing period. Groundwater mounding of ~ 0.4 ft or greater was observed at all four of the MWs during the air sparge tests (**Figure 5-1**). An increase in DO of ~ 0.6 mg/L and bubbling was recorded at PMW-1 (which was located ~ 12.5 ft from the air sparge well (**Figure 5-2**)), at 5 SCFM. Bubbling was also recorded at PMW-3 at a sparge rate of 5 SCFM, although a consistent increase in DO was not observed. No bubbling was observed at PMW-2 (14.5 ft) or PMW-4 (24.5 ft) during testing. No DO increases were observed between measurements taken before sparging began and measurements taken at the end of the sparge test at well PMW-2. No DO measurements were collected at well PMW-4.

Based on these data, a second sparge test was performed on May 16, 2011, using monitoring well PMW-2 as the sparge well. The well was sparged at incremental flow rates of approximately 2.0, 4.0 and 5.0 SCFM for up to 2 hours at each flow rate. As with the first sparge test, the nearby four wells (BSW-1, PMW-1, PMW-3 and PMW-4) were monitored for groundwater mounding and bubbling. Monitoring wells PMW-3 and PMW-4 were monitored during the test for changes in DO concentrations. Groundwater mounding between 0.50 feet and 0.66 feet was observed at the four monitoring wells. Bubbling was observed in well PMW-3 throughout the test, and in PMW-4 when the sparge rate was increased to 5.0 SCFM at PMW-2. An increase in DO of ~1.9 mg/L was observed at PMW-3, with no increase observed at PMW-4.

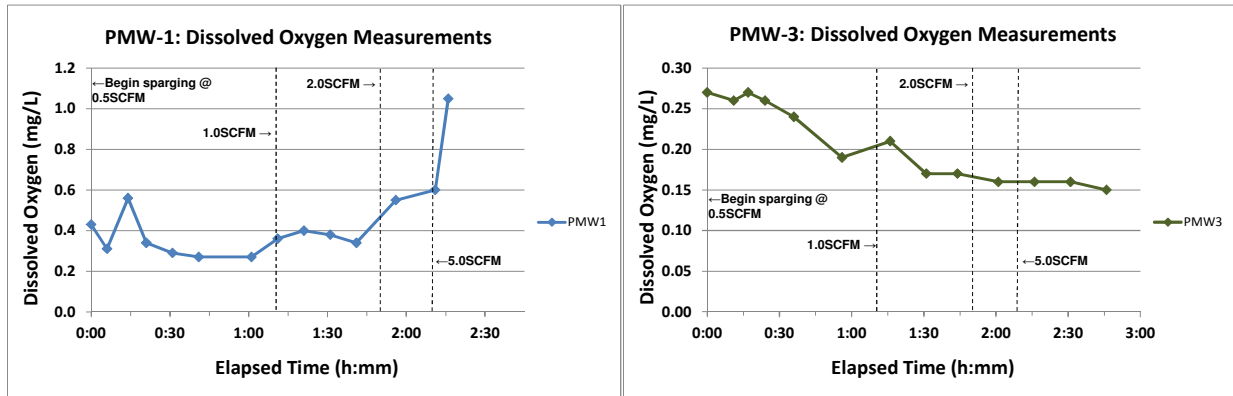
The data suggest that there is site heterogeneity, as expected, but also provide reasonable assurance that sparging would supply necessary gases within a reasonable radius from the sparge well (i.e., 12.5 ft). It should also be noted that sparge well BSW-1 was screened over a 20 ft interval, and potentially multiple conductive layers, so some of the air is likely to have flowed through conductive layers not intersected by the MW screens, thus reducing the radius of influence in these conductive layers. As discussed in **Section 5.2.6**, results of this testing, and generation of detailed cross sections using lithologic data collected during the installation of monitoring wells PMW-1 through PMW-4 during site characterization activities, lead to the decision to over-drill biosparging well BSW-1 for the installation of biosparging well BW-3, which was constructed with 5 feet of screen.



**Figure 5-1. Groundwater mounding measurements in PMW-1 to PMW-4 during air sparge testing at BSW-1.** The air flow rates are provided for each well and a view of the approximate well locations is provided in the bottom panel.



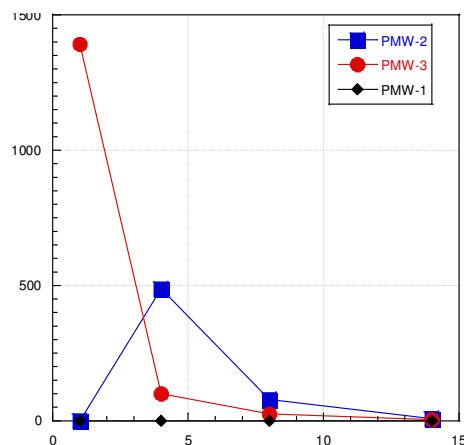
**Figure 5-2. Dissolved oxygen in PMW-1 and PMW-3 during air sparge testing at BSW-1.** The air flow rates are provided for each well.



### 5.2.9 Bromide Tracer Testing

On June 27, 2011, a simple bromide tracer test was performed primarily to estimate/verify the groundwater flow rate and direction at the site. Injection of a slug of the conservative tracer bromide (in the form of sodium bromide) was performed at PMW-3. The tracer solution was prepared from sodium bromide and groundwater extracted from PMW-3 in a poly tank to a final concentration of 2,730 mg/L as bromide. A total volume of 30 gallons of bromide solution was injected into well PMW-3. Based on existing site hydrogeologic data for the demonstration area and the measured groundwater gradient, a linear groundwater velocity between 2 and 20 ft per day was anticipated in the TPA. Sampling for bromide at the injection well (PMW-3) and two downgradient monitoring wells was conducted on Days 1, 4, 8, and 14 after bromide addition. Bromide was detected within 4 days in PMW-2, which was ~ 10 ft downgradient from PMW-3, giving an estimated flow rate of ~ 2.5 ft/day (**Figure 5-3**). Bromide was not detected in well PMW-1, which was significantly offset to the east of PMW-3. Subsequently, a follow-on passive flux meter test was performed in three of the wells to better quantify groundwater flow rate (see next section).

**Figure 5-3. Bromide concentrations in PMW-2, PMW-3 (used as injection well), and PMW-4 during tracer study.**

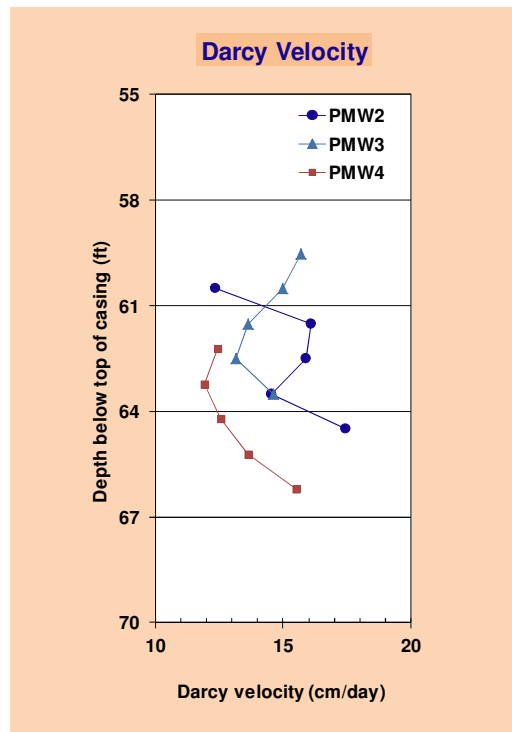


### 5.2.10 Passive Flux Meter Testing

Passive flux meters (PFMs) were installed in three wells (PMW-2, PMW-3, and PMW-4) to provide a second estimate of the groundwater velocity within the demonstration zone (Annable et al., 2005). Additionally, the PFMs were used to better identify conductive zones within the treatment zone interval (approximately 60-65 ft bgs) and in delineating the vertical velocity profile. PFMs consist of activated carbon contained in nylon mesh socks that are lowered into the screen interval of groundwater monitoring wells. The activated carbon is pre-loaded with a suite of alcohol tracers that desorb from the carbon due to groundwater flow. The alcohols that were pre-loaded onto the carbon in the PFMs included methanol, ethanol, isopropyl alcohol (IPA), and 2,4-dimethyl-3-pentanol (DMP). After one week, the PFMs were removed from the monitoring wells, and the carbon was analyzed for alcohols at the University of Florida. Based on the mass of alcohols remaining, the groundwater velocity was estimated in each well (Annable et al., 2005). Analysis of alcohol concentrations along the vertical length of the PFM sock is used to determine the vertical velocity profile.

As shown in **Figure 5-4**, The PFM analysis revealed Darcy velocities in each well ranging from ~ 12 to 17 cm/day, which equates to 0.4 to 0.6 ft per day, with wells generally showing an increased velocity with depth in the interval tested. The average velocity was 0.47 ft/day based on all measured values. This is in reasonable agreement with the bromide tracer test that was conducted, which gave a rough estimate of ~ 2.5 ft/day in the TPA.

**Figure 5-4. Darcy velocity in PMW-2, PMW-3, and PMW-4 based on passive flux meter testing.**



## 5.3 LABORATORY STUDY RESULTS

In preparation for the field demonstration, a series of laboratory batch and column studies were completed. The objectives of the treatability studies were as follows: 1) to determine if indigenous propanotrophs in the expected TPA could be stimulated via propane and oxygen addition to biodegrade NDMA; (2) to determine if these organisms could achieve low ng/L NDMA concentrations during biodegradation; (3) to estimate the kinetics of *in situ* NDMA biodegradation; and (4) to determine if the common co-contaminants TCE and Freon-113 affect NDMA biodegradation and/or if these contaminants are biodegraded by native propanotrophs. Extensive details of laboratory treatability testing results were submitted to ESTCP in the form of a *Treatability Study Report* (Hatzinger, 2010). A Go/No Go decision was made via conference call with ESTCP based on the treatability data in October, 2010. The decision was made to proceed with the field study. The following is a summary of the methods and findings of the treatability testing.

### 5.3.1 Groundwater Sample Collection

During the initial evaluation of site data and conditions, an area near Alder Creek where NDMA is captured by the GET A system was selected as a likely location for the demonstration (see **Figure 4-3**). For treatability studies, groundwater was initially obtained from extraction well 4100 in OU-4. Groundwater samples were collected into 1L glass bottles from a sampling port on extraction well 4100 (which is in operation). The bottles were filled (with minimal headspace) and shipped overnight on ice to the CB&I Laboratory in Lawrenceville, NJ. All samples were stored at 4°C until use in treatability studies. Additional groundwater samples were collected during the course of the treatability work from EW 4100 and EW 4120, since the co-contaminant concentrations in these wells differed somewhat, with EW 4120 having higher concentrations of Freon-113 and TCE.

### 5.3.2 Collection of Aquifer Solids

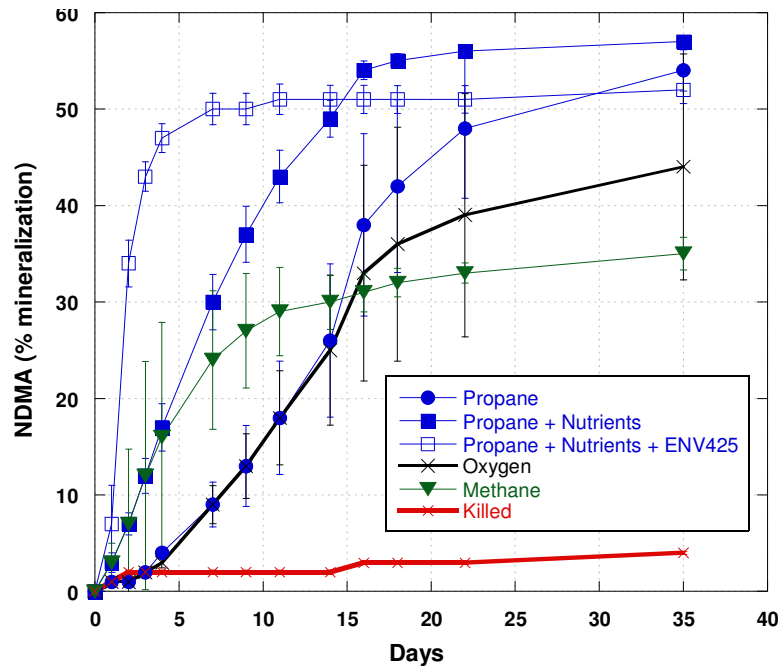
Aquifer solids were collected in the vicinity of EW 4100 using a roto-sonic drilling rig (also called vibratory or sonic drilling). During roto-sonic drilling, a continuous sample core is collected as the core barrel is advanced. Temporary casing is then advanced over the core barrel, and the core barrel is withdrawn from the borehole, where the continuous sample is extruded from the core barrel. Multiple samples were collected with depth to provide a representative sample of the saturated region of the test area. Subsamples of the core material (6 samples; 1 ft length) were collected at intervals below the water table (encountered at 26 ft bgs) corresponding to the screened interval of local groundwater wells (~ 50 – 75' bgs). The samples were taken at 59 – 60', 60 – 61', 64 – 65', 65 – 66', 69 – 70', and 74 – 75' bgs, respectively. These samples were collected Zip-Loc style bags, sealed tightly, and then shipped on ice to the CB&I laboratory in Lawrenceville, NJ. Upon arrival at the Lawrenceville laboratory, aquifer solids were placed at 4°C. Prior to use in microcosm and column studies, all the aquifer solids were homogenized and passed through a coarse sieve (0.75" diameter mesh) to remove large gravel. The sample preparation was conducted aerobically, and care was taken to avoid microbial contamination.

The homogenized aquifer solids were placed in large glass jars with Teflon seals at 4°C prior to use in studies.

### 5.3.3 Batch and Microcosm Studies

Initial batch tests were conducted by pre-incubating groundwater and aquifer solids collected from Zone 4 at Aerojet with propane gas (and methane in some initial experiments) and oxygen for 4-6 weeks, and then adding either  $^{14}\text{C}$ -NDMA (for mineralization tests) or “cold” (i.e., non-radiolabeled) NDMA (to evaluate the extent of biodegradation). The batch experiments clearly showed that bacteria capable of biodegrading NDMA are present in the groundwater aquifer at the Aerojet site. Initial microcosm studies with  $^{14}\text{C}$ -NDMA showed that these organisms could be stimulated to biodegrade NDMA via addition of methane, propane, or a combination of both gases under aerobic conditions, and that the addition of inorganic nutrients and/or the propanotroph ENV425 enhanced biodegradation rates (**Figure 5-5**).

**Figure 5-5. Mineralization of  $^{14}\text{C}$ -NDMA to  $^{14}\text{CO}_2$  in Aerojet microcosms pre-incubated with propane, propane + nutrients (+/- ENV425), methane, or oxygen.**



### 5.3.4 Mesocosm Studies

In large scale mesocosms designed to evaluate whether indigenous bacteria could biodegrade NDMA to low ng/L concentrations, propane and methane were again observed to stimulate NDMA biodegradation. However, over a longer incubation time with the alkane gases, biodegradative activity appeared to cease (with the exception of one bottle with both methane and propane gas added), and could not be re-initiated by addition of trace nutrients, different gas mixtures, or incubation at higher temperature (see Hatzinger, 2010 for details). The addition of yeast extract (YE; primarily as a vitamin source) enhanced activity, but this effect was independent of the stimulation of indigenous cultures by propane or methane gas. Bioaugmentation with the propanotroph ENV425 also enhanced NDMA biodegradation in mesocosms, and NDMA concentrations of < 5 ng/L were achieved in samples receiving the culture.

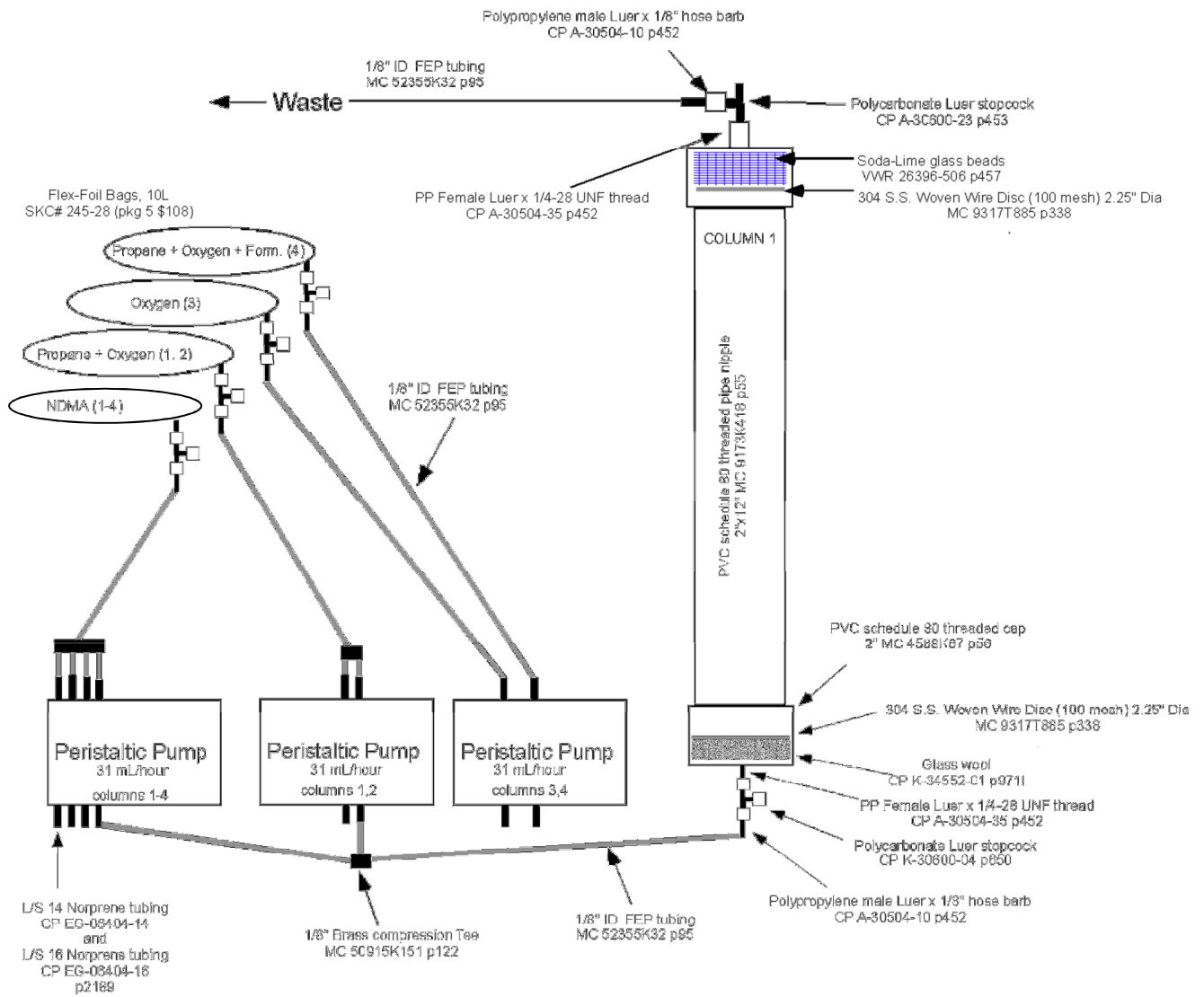
The overall loss of degradative activity in the mesocosm bottles could be hypothesized to have several potential causes, including (1) toxicity of a degradation intermediate or other compound; (2) a nutrient or vitamin limitation in the closed batch system; or (3) a shift in microbial community. The fact that the addition of either YE or strain ENV425 to samples from the mesocosm bottles stimulated NDMA biodegradation suggests that the issue was not cell toxicity. Also, the likely degradation route of NDMA (and propane) by propanotrophs does not produce any intermediates with significant microbial toxicity (Fournier et al., 2009). Moreover, limitation of key inorganic nutrients (e.g., N & P) is unlikely as diammonium phosphate was periodically added to the various treatments, and the addition of trace nutrients had little effect on NDMA biodegradation. One possibility is that the microbial community in the bottles shifted over time, resulting in either the loss of indigenous propanotrophs or a shift to species that did not cometabolize NDMA or degraded NDMA more slowly in the presence of propane as a growth substrate. This type of shift may be an artifact of long-term incubation in a mesocosm with no addition of fresh groundwater. Another possibility is that incubation at 15°C reduced rates of propane mineralization compared to room temperature, and that the aqueous propane (as a growth substrate) inhibited NDMA biodegradation, although this was not indicated when samples were collected from the bottles and incubated at different temperatures. TCE and Freon-113 were only present at trace concentrations during the microcosm/mesocosms studies, so inhibitory effects of these co-contaminants are unlikely in these studies.

In previous experiments, we have sometimes observed significant differences in contaminant biodegradation between batch and flow-through column studies. For example, when evaluating biodegradation of the nitramine explosives RDX and HMX, the latter compound did not biodegrade in batch studies, but degraded readily in columns prepared with materials from the same site (Schaefer et al., 2007). In some instances, because of the constant influx of fresh groundwater (and associated electron acceptors, nutrients, etc.), flow-through columns may better simulate field conditions, at least when evaluating processes that occur with rapid kinetics. The potential complication with column studies is that residence times are often much shorter than in aquifers, so slower processes are much more difficult to evaluate. Column studies were subsequently conducted as part of this site specific treatability study to evaluate NDMA biodegradation under flow-through conditions (**Section 5.3.5**).

### 5.3.5 Column Studies

Four columns were prepared with aquifer solids from the Aerojet site, and artificial groundwater (simulating Aerojet water without co-contaminants) was initially passed through these columns (**Figure 5-6**). One column received propane, oxygen, yeast extract (YE), and inorganic nutrients (C1); a second received propane and oxygen only (C2); a third column received oxygen only (C3); and a fourth received oxygen, propane, and formaldehyde as a killing agent (C4). The hydraulic residence time (HRT) of groundwater in the columns through much of the 217-day study was 15 hr, simulating a field flow rate of ~ 1.6 ft/day. Propane was fed to the columns at 2-4 mg/L and oxygen at 6-8 mg/L. Between Days 101 and 144, Aerojet site water was fed to the columns, and additional TCE and Freon-113 were added from Day 126-144 to simulate the maximum concentrations that may occur at the Aerojet site. The Aerojet water was replaced with artificial groundwater without co-contaminants from Day 145-217 (see **Table 5-4** for flow and water sources). Samples were collected throughout the study for analysis of NDMA, propane, oxygen, and other parameters. At the conclusion of the study, microbial community analysis was conducted with aquifer solids from C2 (propane and oxygen) and C3 (oxygen only) to evaluate dominant organisms and to quantify propane monooxygenase (PMO; enzyme responsible for propane and NDMA oxidation in propanotrophs) levels.

**Figure 5-6. Flow-through model aquifer columns used to evaluate NDMA biodegradation in site materials.**





**Table 5-4. Operational Conditions for the Flow-Through Aquifer Columns.**

| <b>Days</b> | <b>Conditions</b>                                | <b>Flow rate</b> |
|-------------|--|------------------|
| 0-52        | Artificial groundwater                           | 52 mL/hr         |
| 53-100      | Artificial groundwater                           | 14 mL/hr         |
| 101-125     | Aerojet groundwater                              | 14 mL/hr         |
| 126-144     | Aerojet groundwater with Freon-113 and TCE added | 14 mL/hr         |
| 145-217     | Artificial groundwater                           | 14 mL/hr         |

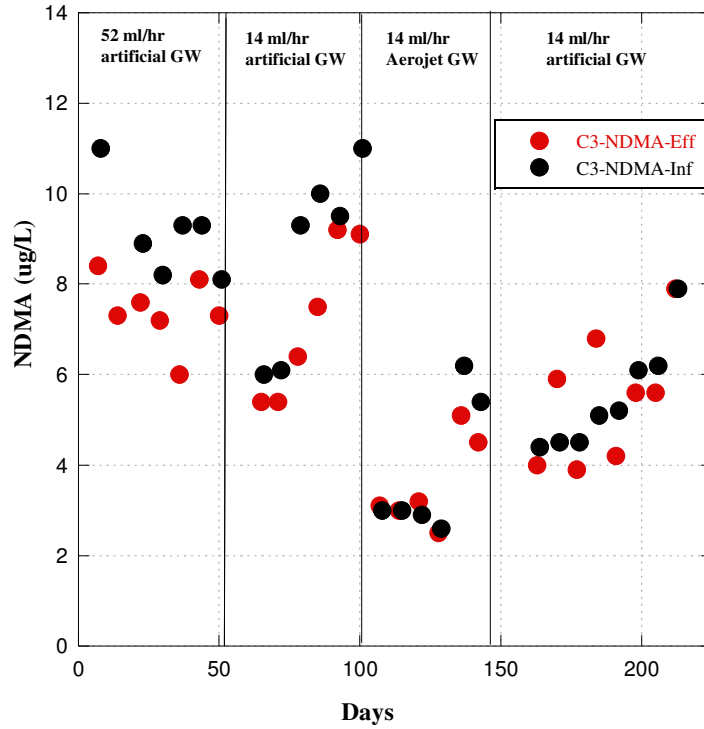
There was no appreciable loss of NDMA in C3 (oxygen only) or C4 (killed) during the study, suggesting that aerobic biodegradation in the absence of co-substrate is not a significant removal mechanism for NDMA (**Figures 5-7 and 5-8**). The effluent NDMA concentration in C2 (oxygen and propane only) declined significantly during the initial several weeks of column operation. Between Days 78 and 101, the average influent NDMA concentration to C2 was  $8.6 \pm 0.1 \mu\text{g/L}$  and the effluent concentration was  $0.02 \pm 0.03 \mu\text{g/L}$  (**Figure 5-9**). In C1 (propane, oxygen, YE, and nutrients), NDMA concentrations in the column effluent also declined appreciably, reaching  $0.035 \mu\text{g/L}$  on Day 65. However, unlike C2 which received propane and oxygen only, the NDMA concentrations in the effluent water increased thereafter in C1, ranging between 1 and  $4.6 \mu\text{g/L}$  for the next 4 weeks (**Figure 5-10**). The reason for this sudden increase is unclear, but probably reflects a shift in the microbial community composition away from organisms capable of degrading NDMA due to the presence of YE. Nearly complete propane degradation was observed during this period in both C1 and C2, showing that propanotrophs were active (see Hatzinger, 2010).

For C2, rates of propane, oxygen, and NDMA degradation generally increased with time, likely due to growth of biomass within the columns. Maximum oxygen and propane consumption rates, attained after approximately 50 days, were  $0.3 \text{ mg/L/hr}$  and  $0.2 \text{ mg/L/hr}$ , respectively. The rate of NDMA biodegradation was greatest between 75 and 110 days, with concentrations decreasing from approximately  $8.6 \mu\text{g/L}$  to  $0.02 \mu\text{g/L}$  within the 15 hr residence time of the column (14 mL/hr flow rate). Based on the data from 75 to 100 days, a first order biodegradation rate constant of 0.45/hr was calculated for NDMA. Results from C1 are generally consistent with that of C2, although the addition of yeast extract to C1 eventually reduced the rate of NDMA biodegradation as detailed previously.

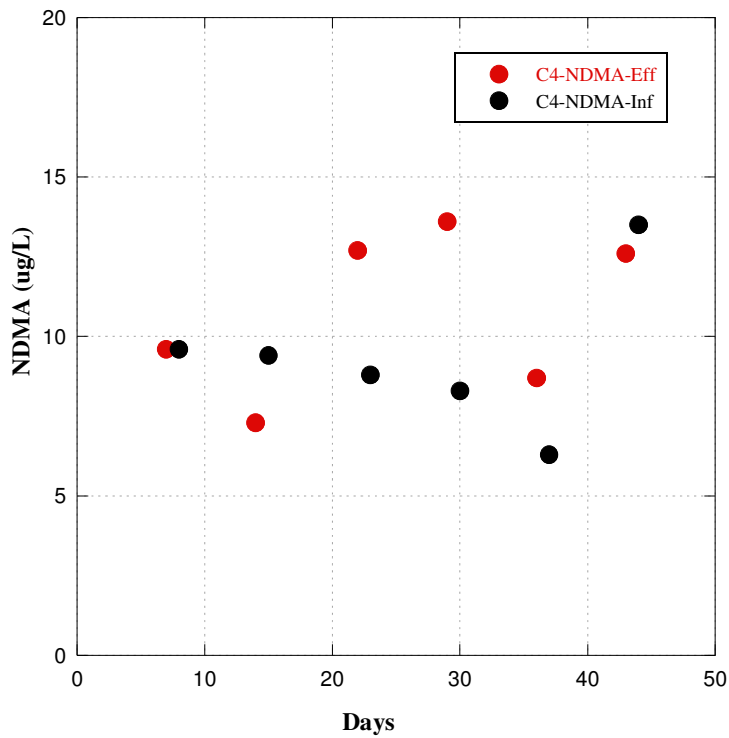
When concentrations of TCE and Freon-113 were increased in C1 and C2 (Days 126-144) to a maximum of  $\sim 150 \mu\text{g/L}$  and  $1 \text{ mg/L}$ , respectively, biodegradation of NDMA decreased sharply (**Figure 5-9** [NDMA] and **Figure 5-11** [TCE and Freon-113]). Influent and effluent concentrations of NDMA were similar during this period in both C1 and C2. Propane degradation rates were also reduced during this time, suggesting some cell toxicity. When the high concentrations of TCE and Freon-113 were removed on Day 144, propane degradation quickly returned to previous rates (**Figure 5-12**). This suggests that the microbial communities

recovered. This observation is supported by the detection of propanotrophic bacteria and high levels of PMO in C2 at the conclusion of the study. The results of the analysis showed approximately 10-fold higher numbers of organisms with PMO in the propane-fed column ( $4.0 \times 10^5$  cells/g) compared to the oxygen-fed column ( $4.7 \times 10^4$  cells/g) based on qPCR, and a greater diversity of these bacteria (**Figure 5-13**). However, the extent of NDMA biodegradation never returned to levels observed before amendment of groundwater with Freon-113 and TCE. From Day 145 to Day 217, after TCE and Freon-113 were removed, influent concentrations of NDMA in C1 and C2 averaged  $\sim 4.3$   $\mu\text{g/L}$  and effluent concentrations averaged  $\sim 2$   $\mu\text{g/L}$ . Freon-113 was detected in the column effluent at concentrations ranging from  $\sim 5$  to  $20$   $\mu\text{g/L}$  during this time, presumably due to leaching from tubing, Flex-foil bags, etc., and it is likely that the continued presence of this compound slowed rates of NDMA biodegradation. It was not possible to increase column HRT due to pump limitations (i.e., pumps were set at the slowest speed possible), however, increasing the HRT (e.g., from 15 hr to 3 days) may have resulted in much lower effluent NDMA levels. For example, in mesocosms prepared from a site in NJ, NDMA biodegradation was unaffected by the presence of TCE at 2 mg/L in the aqueous phase (see **Figure 5-14**). In fact, both TCE and NDMA were biodegraded simultaneously. In the field at Aerojet, longer residence times would be expected, so the effects of the co-contaminants on NDMA biodegradation would be potentially less significant than observed in the column study. However, to avoid potential inhibition of NDMA degradation by the VOCs in the EW 4100 area, a nearby location was selected for the TPA where VOCs were absent.

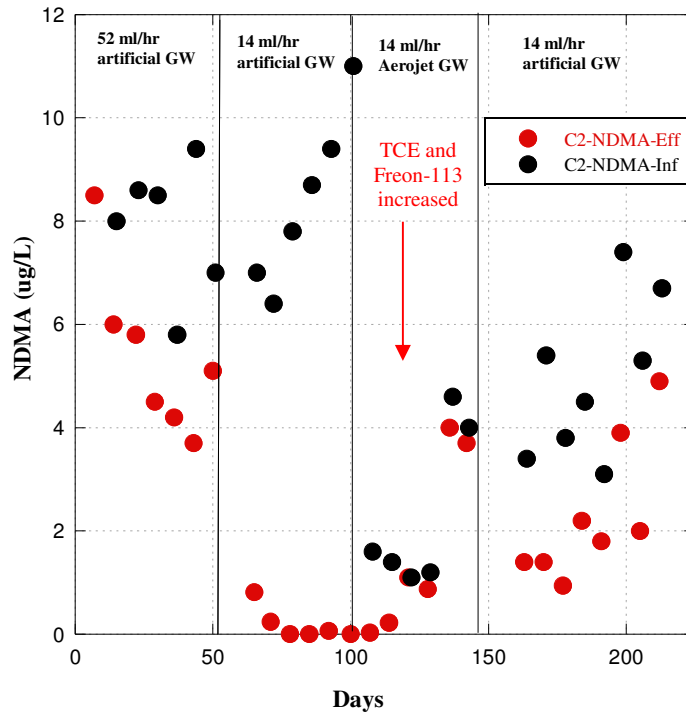
**Figure 5-7. NDMA concentrations in influent and effluent water from Column 3 (C3: oxygen only).**



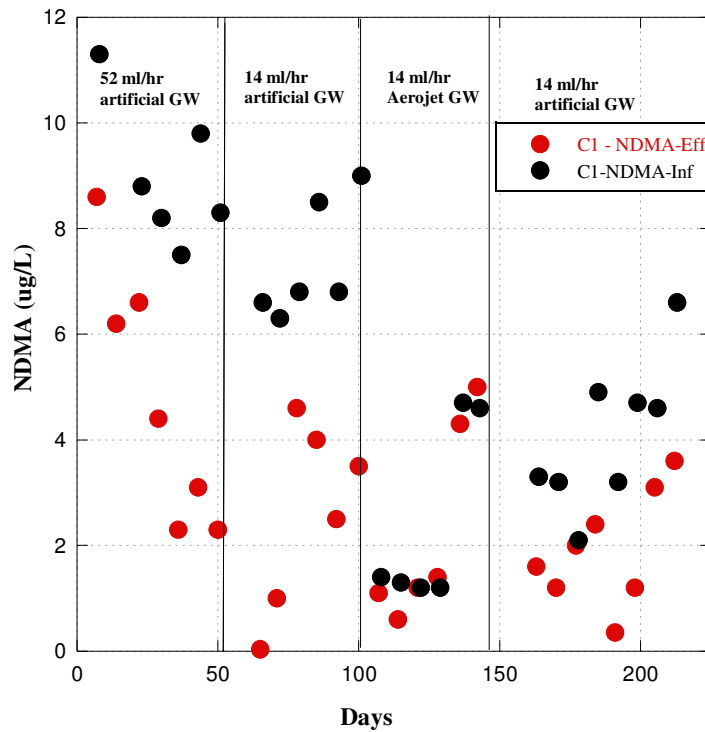
**Figure 5-8. NDMA concentrations in influent and effluent water from Column 4 (C4: propane, oxygen, formaldehyde).**



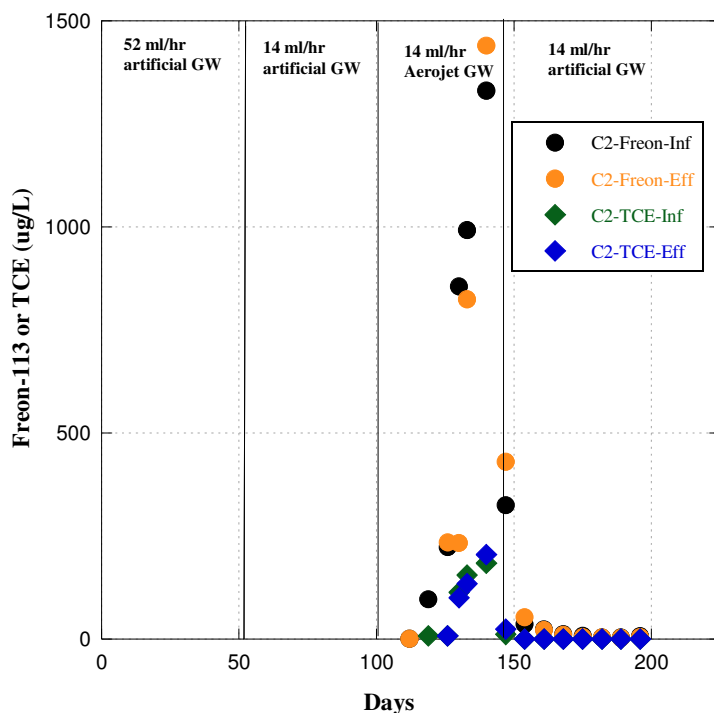
**Figure 5-9. NDMA concentrations in influent and effluent water from Column 2 (C2: propane, oxygen).**



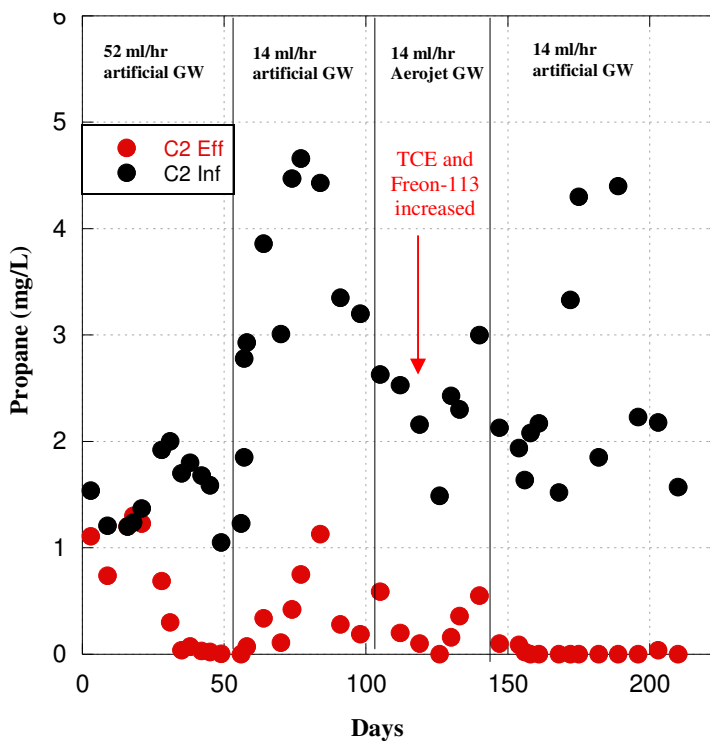
**Figure 5-10. NDMA concentrations in influent and effluent water from Column 1 (C1: propane, oxygen, YE, nutrients).**



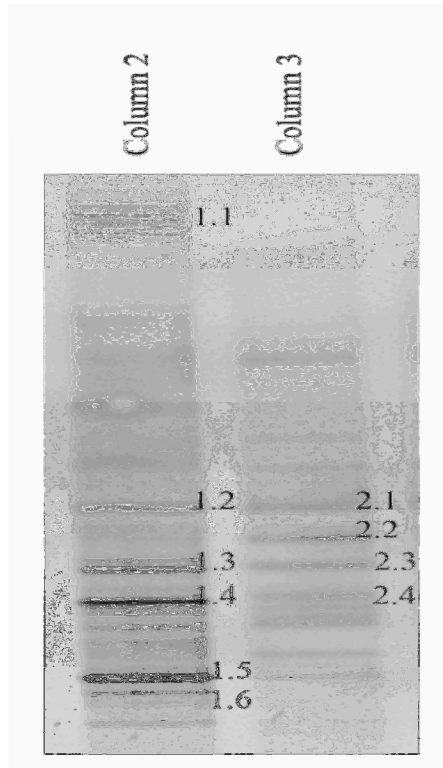
**Figure 5-11. TCE and Freon-113 concentrations in influent and effluent water from Column 2 (C2: propane, oxygen).**



**Figure 5-12. Propane concentrations in influent and effluent water from Column 2 (C2: propane, oxygen).**



**Figure 5-13. DGGE gels from C2 and C3 (top panel) and microbial identifications of each band via 16S rDNA analysis (bottom panel).**

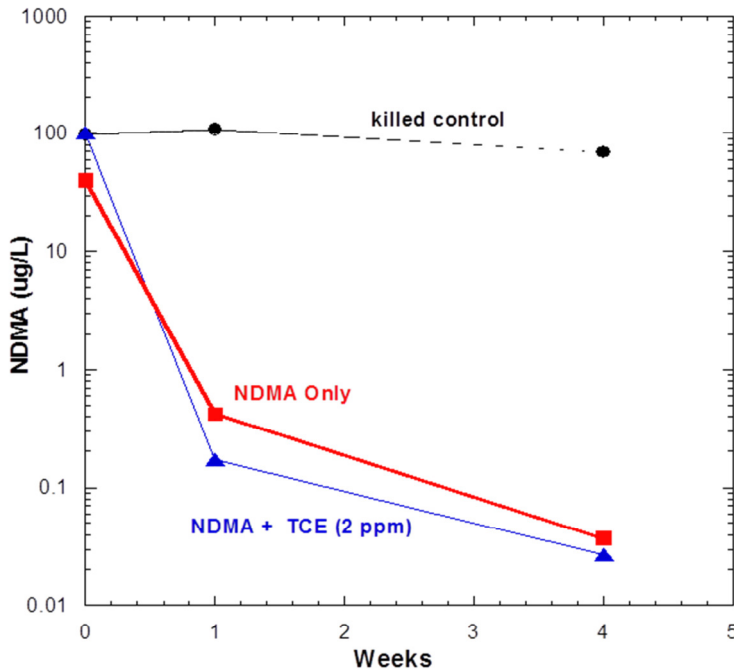


| <b>Band</b> | <b>Similar genus</b>           | <b>Similarity Index</b> |
|-------------|--------------------------------|-------------------------|
| 1.1         | <i>Sphingobacterium</i>        | 0.932                   |
| 1.2         | <i>Devosia spp.</i>            | 0.981                   |
| 1.3         | <i>Sterolibacterium spp.</i>   | 0.879                   |
| 1.4         | <i>Methylibium spp.</i>        | 0.956                   |
| 1.5         | <i>Actinomycetales</i>         | 0.658                   |
| 2.1         | <i>Devosia spp.</i>            | 0.951                   |
| 2.3         | <i>Rhodocyclaceae (family)</i> | 0.879                   |
| 2.4         | <i>Methylibium spp.</i>        | 0.956                   |

### 5.3.6 Conclusions from Laboratory Studies

The conclusion of the treatability work for this project marked a Go/No-Go decision point for the field study at Aerojet. Overall, the treatability results revealed that propane (and methane) degrading bacteria are present at the Aerojet site, and that these bacteria can be stimulated to biodegrade NDMA from  $\mu\text{g/L}$  to  $\text{ng/L}$  concentrations. Batch and column studies confirmed these observations. However, the batch data suggested that NDMA biodegradation can decline with time (which may be an artifact of the closed system), and the column results clearly showed that high concentrations of co-contaminants in the Aerojet water (TCE and Freon-113) can significantly reduce rates of NDMA degradation. Based on the treatability studies, we proposed to move forward with the field study, but to either (1) use a modified field design which enabled us to remove TCE and Freon-113 *in situ* with traditional air-sparging prior to stimulating NDMA biodegradation via propane addition or (2) evaluate alternate locations at Aerojet (but within the same general region where the treatability studies were conducted) that have NDMA, but lower levels of TCE and Freon-113 ( $< 50$  and  $100 \mu\text{g/L}$  respectively). After significant additional site assessment work was conducted, the latter alternative was selected. A suitable location in the general region where samples were collected for the treatability studies was found with high NDMA concentrations ( $> 10 \mu\text{g/L}$ ) but with non-detectable levels of VOCs. This Alder Creek site north of MW 4125 is shown in **Figure 4-9**.

**Figure 5-14. NDMA concentrations in samples from Picatinny Arsenal, NJ in the presence of absence of TCE (2 mg/L).** TCE caused no difference in either the rate or extent of NDMA biodegradation, and TCE biodegraded simultaneously (from Hatzinger et al., 2008)



## 5.4 DESIGN AND LAYOUT OF TECHNOLOGY COMPONENTS

As previously discussed, *in situ* remediation of NDMA via co-metabolism requires the addition and distribution of propane gas and oxygen in groundwater. For this demonstration, we used using an air- and propane-biosparging approach to deliver these gases to the subsurface (**Figure 2-1**). Although biosparging is a form of air sparging, the focus is on providing the necessary gases for contaminant biodegradation, while minimizing volatilization. The key objective is to evenly distribute propane and oxygen gas throughout the desired treatment area in the safest and most cost-effective manner. The following subsections detail the design and layout of the various demonstration components.

### 5.4.1 Demonstration Plot Layout

The original demonstration plot for this project included 5 biosparging wells and 7 groundwater monitoring wells as shown on **Figure 5-15**. The details of well installation are provided in **Section 5.2.6**. Upon system start-up, the pressure at all 5 of the installed system biosparging wells significantly exceeded initial expectations of 25-30 psi based on initial sparge testing in BSW-1 (**Section 5.2.8**). In fact, gas break-out of air flow (as indicated by a significant drop in well pressure indicative of gas movement into the formation) did not occur at four of the five wells even at pressures of > 60 psi. Well BW-4 did break-out and sustain low gas flow at a pressure of ~ 40 - 45 psi. However, this well stopped being operational after a short period of time. These results were unexpected, as previous sparge tests at the demonstration site showed much lower break-out pressures (~ 25 to 30 psi) in the previously installed monitoring wells. This issue was traced to the use of specialized sparge screens (SHUMASOIL porous polyethylene well screens; <http://www.ectmfg.com/Product/WellConstructionSupplies/Schumasoil.html>) in each of the sparge wells. Although these screens are designed specifically for even gas flow in air sparge applications and have greater surface area than similar slotted screens, air flow through these screens could not be attained at reasonable injection pressures. Furthermore, it is also likely that one or more of the screens collapsed after sparge testing based on well depth measurements. The reason for the well screen failures is unknown. However, discussions with the manufacturer suggested that improper storage of the screens by the distributor could have led to deterioration of the screens, as degradation of the screen material can result from extended exposure to sunlight.

Because of the initial issues with the biosparge wells, the decision was made to utilize one of the central monitoring wells (PMW-1), which was built with a traditional screen, for biosparging. The breakthrough pressure for this well was consistently been between 25 and 35 psi. In the event that the radius of influence of this well was not sufficient to provide gases throughout the demonstration plot, a plan was made to install two new sparge wells with traditional screens. As detailed further in **Section 5.4**, these two wells were installed ~ 4 months after the initial system start-up. The final demonstration plot design is provided in **Figure 5-16** (and a smaller version in **Figure 3-1**). This was the demonstration plot layout for the majority of the demonstration, with PMW-1 used as the third system biosparge well as well as a system monitoring well. It is this finalized design that is primarily discussed throughout this this document.



The final demonstration plot included 3 biosparging wells and 7 monitoring wells (**Figure 5-16**). Monitoring wells were divided into three groups:

- One sidegradient (or “background”) monitoring well (BMW-1) located ~75 ft sidegradient of the central part of the test plot,
- Four treatment zone performance monitoring wells (PMW-1, PMW-2, PMW-3, PMW-4), located within (PMW-1, PMW-2), slightly upgradient (PMW-3, ~ 4 ft), and slightly downgradient (PMW-4, ~ 7 ft) of the triangulated propane sparge wells, and
- Two downgradient monitoring wells (PMW-5 and PMW-6) located ~ 30 to 40’ downgradient of the central region the triangulated propane sparge wells.

Background well BMW-1 was located outside the influence of the biosparging system and was used to verify NDMA and other groundwater contaminant concentrations flowing side-gradient of the treatment area. Performance monitoring wells PMW-1 through PMW-4 were used to verify propane and oxygen distribution, propanotroph numbers, and treatment effectiveness within the treatment zone. It should be noted that PMW-1 was also used as a biosparge well throughout the demonstration as previously described in this section. Performance wells PMW-5 and PMW-6 were used to evaluate treatment effectiveness downgradient of the treatment zone.

The three biosparging wells were located in a triangle with distances ranging from ~ 12 ft to 18 ft apart as shown in **Figure 5-16**.

#### **5.4.2 Monitoring and Biosparging Well Installation**

The monitoring wells and biosparging wells were installed in three separate events. The initial set of wells (BSW-1, PMW-1, PMW-2, PMW-3, PMW-4) were installed in order to complete necessary sparge testing activities as described previously in **Sections 3.2** and **5.2.8**. An initial well was also installed in the GET A pond area during this event to evaluate the potential use of this area for testing activities. Installation of the initial set of wells in the TPA is described in detail in **Section 5.2.6**.

During the second event, the remaining wells for the test plot were installed, including 5 biosparge wells (BW-1 to BW-5), two downgradient monitoring wells (PMW-5, PMW-6), and the side-gradient control well (BMW-1). Biosparging well BSW-1, which was installed with 20 feet of screen, was over-drilled for the installation of biosparging well BW-3, which was constructed with 5 feet of screen, after it was determined that BSW-1 spanned more than one conductive layer (**Section 5.2.8**). During the third drilling event, two additional biosparge wells were added to the test plot (BW-6, BW-7) due to the failure of sparge screens on BW-1 to BW-5 as previously described (**Section 5.4.1**).

Prior to drilling during the second and third events, all underground utilities were located and marked. Each borehole was initially advanced to a depth of at least 5 ft bgs by air-knife to clear for any unmarked utilities. The boreholes were then advanced to the pre-determined depth (approximately 65 ft bgs) using sonic drilling equipment. The drilling tools included a 4-inch diameter sonic core barrel followed by a flush threaded 6-inch temporary casing. During

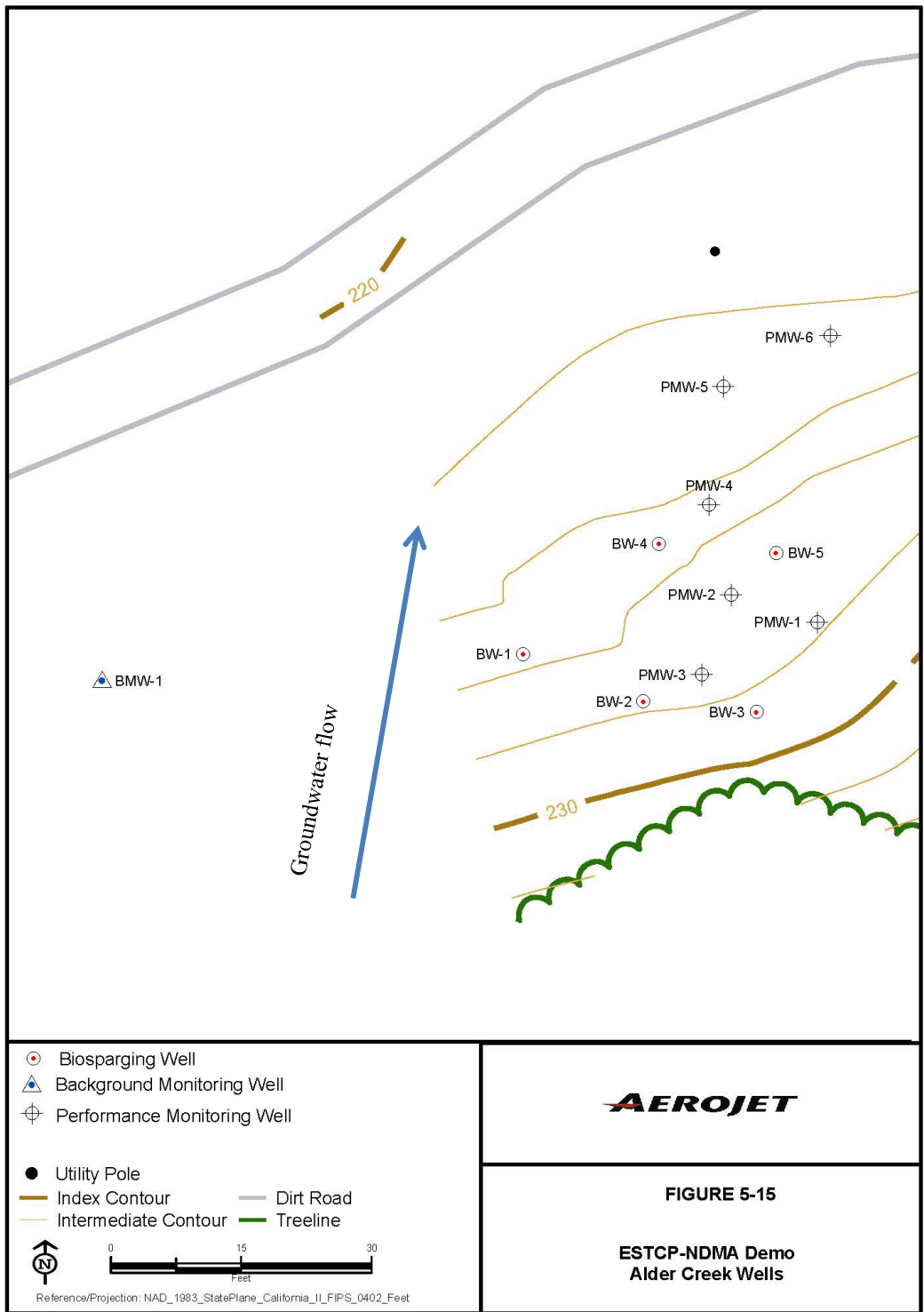
drilling, recovered soil cores were screened for VOCs using a photo-ionization detector (PID) and logged by a CB&I geologist. The well logs are provided in **Appendix C**.

Monitoring and biosparging wells were installed through the six inch temporary casing, and were constructed with flush-threaded, 2 inch diameter, Schedule 40, PVC riser. The monitoring wells and biosparging wells BW-6 and BW-7 were constructed with 5 feet of 0.010-inch slotted PVC well screen. Biosparging wells BW-1 through BW-5 were each constructed with 5 feet of specialized porous polyethylene well screens, as detailed in **Section 5.4.1**. Final screen lengths and intervals at each location were determined based on the lithology observed during drilling and are provided in **Table 5-5**, and **Appendix C**. In general, screen intervals were selected to ensure that the well screen was placed within the treatment zone.

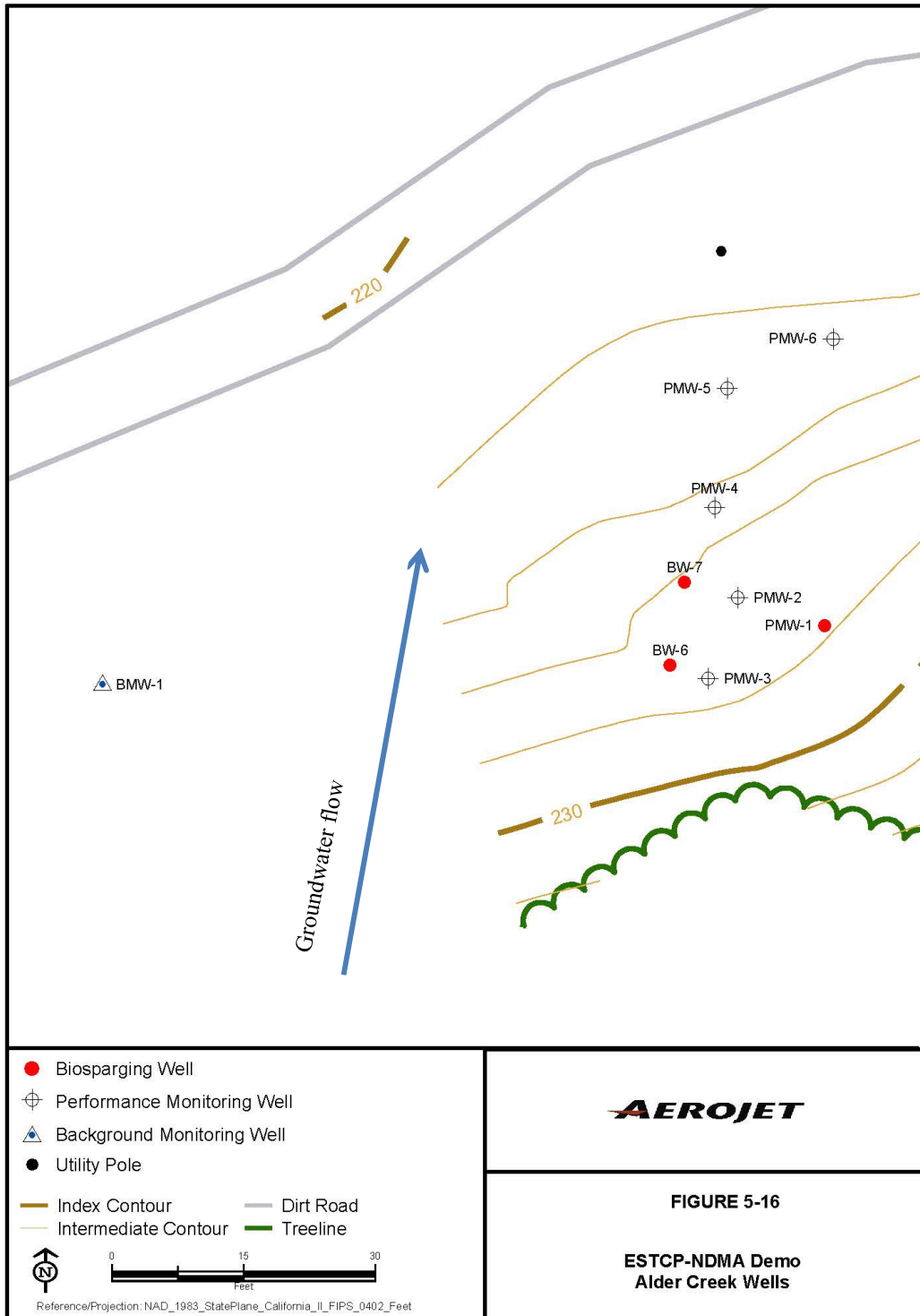
The filter pack for each well consisted of #2/12 sand (or equivalent) extending to 3.0 ft above the top of screen. A minimum 3-ft bentonite seal was placed above the filter pack. The remaining annular space was filled with cement-bentonite grout (no more than five percent bentonite by weight) emplaced to within 2 ft of the surface via Tremie pipe. After the wells were completed, each well was surveyed (except BW-6 and BW-7 which were installed after surveying of all other wells was complete) to determine its horizontal location to within  $\pm 1$  ft, and the elevation of the top of the inner PVC well casing to a  $\pm 0.01$ -ft precision.

Well development was accomplished by pumping the groundwater until the water was clear and the well was sediment free to the fullest extent practical. Wells were developed using a surge block (if necessary) and submersible pump. Water was not added to the well to aid in development, nor was any type of air-lift technique used. The pump, tubing, and surge block were decontaminated between locations. Well development and decontamination fluids were pumped to an on-site temporary storage tank, and disposed of at an on-site groundwater treatment facility.

**Figure 5-15. Original layout of demonstration plot biosparge and monitoring wells.**



**Figure 5-16. Final layout of demonstration plot biosparge and monitoring wells.** The two new biosparge wells were installed approximately 4 months into the demonstration to enhance propane and oxygen concentrations throughout the demonstration plot area.



**Table 5-5. Summary of As-Built Well Construction Details**

| Well ID                 | Date Installed | Well Diameter (inches) | Well Material | Screen Type | Elevations (ft. MSL) |                                   |                | Screen Intervals        |                            |                         |                            | Stick Up or Flushmount | Type of Stickup | Concrete Pad (Y/N) |
|-------------------------|----------------|------------------------|---------------|-------------|----------------------|-----------------------------------|----------------|-------------------------|----------------------------|-------------------------|----------------------------|------------------------|-----------------|--------------------|
|                         |                |                        |               |             | Top of PVC Casing    | Top of Steel Casing or Flushmount | Ground Surface | Top of Screen (ft. bgs) | Bottom of Screen (ft. bgs) | Top of Screen (ft. MSL) | Bottom of Screen (ft. MSL) |                        |                 |                    |
| <b>Sparge Wells</b>     |                |                        |               |             |                      |                                   |                |                         |                            |                         |                            |                        |                 |                    |
| BW-1                    | 11/5/2011      | 2.0                    | PVC           | SHUMASOIL   | 226.76               | NA                                | 225.41         | 57                      | 62                         | 168.41                  | 163.41                     | Stick Up               | PVC only        | N                  |
| BW-2                    | 11/4/2011      | 2.0                    | PVC           | SHUMASOIL   | 229.44               | NA                                | 227.71         | 62                      | 67                         | 165.71                  | 160.71                     | Stick Up               | PVC only        | N                  |
| BW-3                    | 11/3/2011      | 2.0                    | PVC           | SHUMASOIL   | 230.16               | NA                                | 228.57         | 63                      | 68                         | 165.57                  | 160.57                     | Stick Up               | PVC only        | N                  |
| BW-4                    | 11/1/2011      | 2.0                    | PVC           | SHUMASOIL   | 226.66               | NA                                | 225.12         | 70                      | 75                         | 155.12                  | 150.12                     | Stick Up               | PVC only        | N                  |
| BW-5                    | 11/2/2011      | 2.0                    | PVC           | SHUMASOIL   | 227.65               | NA                                | 226.55         | 63                      | 68                         | 163.55                  | 158.55                     | Stick Up               | PVC only        | N                  |
| BW-6                    | 6/20/2012      | 2.0                    | PVC           | Slotted PVC | Not Surveyed         |                                   |                | 71                      | 76                         | Not Surveyed            |                            | Stick Up               | PVC only        | N                  |
| BW-7                    | 6/21/2012      | 2.0                    | PVC           | Slotted PVC | Not Surveyed         |                                   |                | 67                      | 77                         | Not Surveyed            |                            | Stick Up               | PVC only        | N                  |
| <b>Monitoring Wells</b> |                |                        |               |             |                      |                                   |                |                         |                            |                         |                            |                        |                 |                    |
| BMW-1                   | 10/25/2011     | 2.0                    | PVC           | Slotted PVC | 224.13               | 224.59                            | 222.20         | 45                      | 50                         | 177.20                  | 172.20                     | Stick Up               | 6" Steel        | Y                  |
| PMW-1                   | 4/23/2011      | 2.0                    | PVC           | Slotted PVC | 230.22               | 230.72                            | 227.80         | 60                      | 65                         | 167.80                  | 162.80                     | Stick Up               | 6" Steel        | Y                  |
| PMW-2                   | 4/27/2011      | 2.0                    | PVC           | Slotted PVC | 226.50               | 226.85                            | 226.47         | 60                      | 65                         | 166.47                  | 161.47                     | Flushmount             | NA              | Y                  |
| PMW-3                   | 4/26/2011      | 2.0                    | PVC           | Slotted PVC | 227.13               | 227.66                            | 227.29         | 59                      | 64                         | 168.29                  | 163.29                     | Flushmount             | NA              | Y                  |
| PMW-4                   | 4/28/2011      | 2.0                    | PVC           | Slotted PVC | 226.25               | 226.88                            | 224.54         | 60                      | 65                         | 164.54                  | 159.54                     | Stick Up               | 6" Steel        | Y                  |
| PMW-5                   | 10/28/2011     | 2.0                    | PVC           | Slotted PVC | 221.40               | 221.97                            | 221.86         | 57                      | 62                         | 164.86                  | 159.86                     | Flushmount             | NA              | Y                  |
| PMW-6                   | 10/27/2011     | 2.0                    | PVC           | Slotted PVC | 221.12               | 221.89                            | 221.75         | 60                      | 65                         | 161.75                  | 156.75                     | Flushmount             | NA              | Y                  |

### 5.4.3 Biosparging System Design

CB&I refurbished an existing propane biosparging system for use during this demonstration. The trailers were shipped to CB&I's engineering and equipment facility in Findlay, OH where all components were inspected, adjusted and/or replaced as necessary to ensure good operation in the field. The system consists of two mobile trailers (Trailer #1 and Trailer #2) housing equipment and controls. A Process and Instrumentation Diagram (PID) of the system is provided in **Figure 5-17** and a photo of the outside of the trailers is provided in **Figure 5-18**. The use of the existing biosparge trailers allowed for quick and temporary set up on the site, and resulted in significant cost savings for the project.

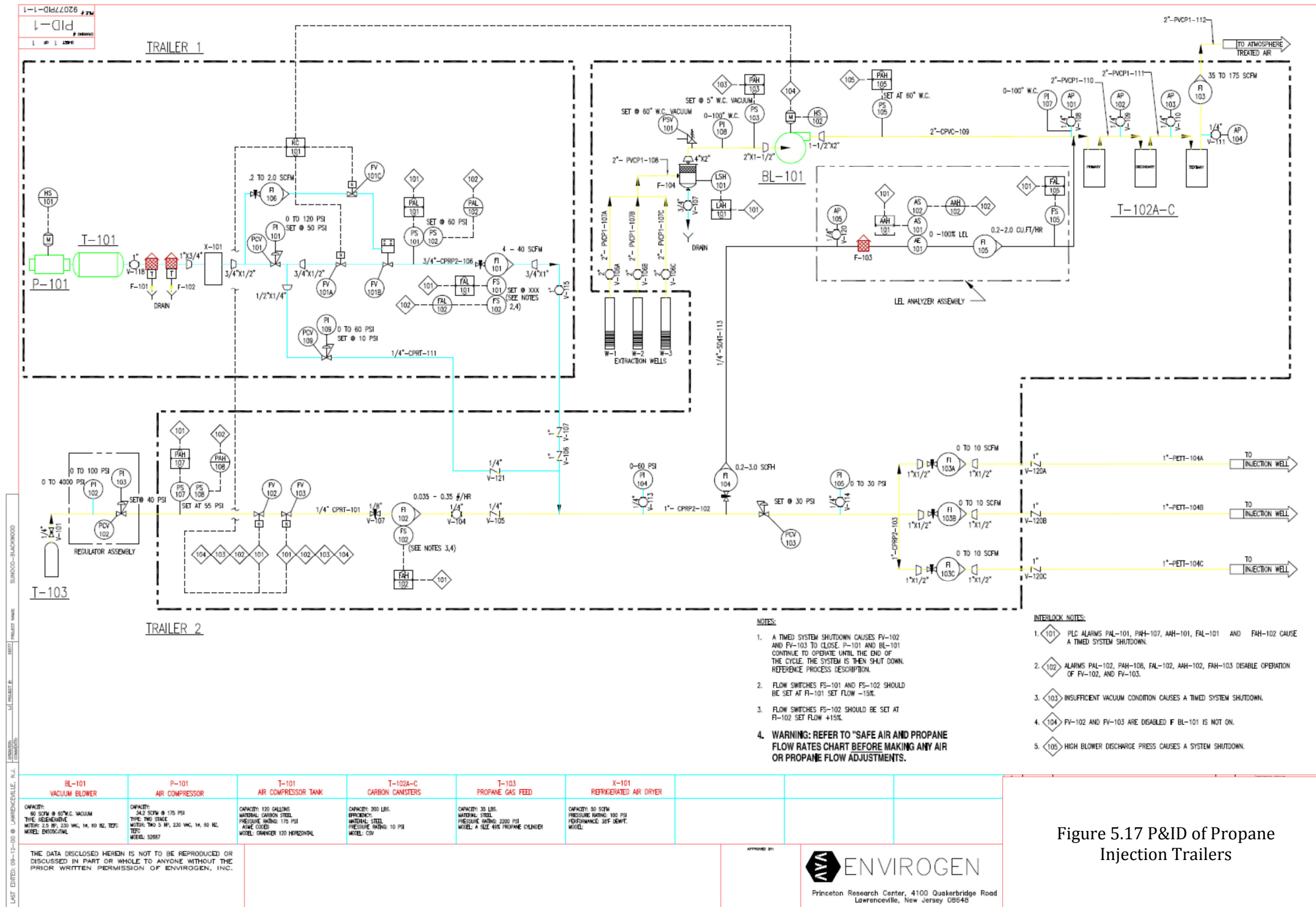


Figure 5.17 P&ID of Propane Injection Trailers

#### 5.4.3.1 Biosparge Trailer #1

Trailer #1 (pictured in **Figure 5-19**) is electrically wired for a non-explosion proof atmosphere. It contains the main control panel and main electrical junction box as well as the air feed system. A 220 VAC, single phase power drop to the system is required to be hard-wired to the main electrical junction box located on the outside of Trailer #1. A PLC and user interface are located within the trailer in the main control panel. Electrical power and control is transferred via flexible cable to Trailer #2. A wireless system was installed to provide for call out when an operating fault was detected.

The air feed system included a two-stage, duplex air compressor w/5 HP motors and a 120 gal tank, capable of providing 34.2 SCFM @ 175 psi. It also included two particulate filters, a 35 SCFM refrigerated air dryer, regulator, control solenoids, pressure switch, control valve, and a mass flow meter that was linked to the PLC. Air is transferred to Trailer #2 via flexible hose. A secondary airline with a regulator is also included to provide venting of the LEL sampling line in Trailer #2 during non-injection periods.

#### 5.4.3.2 Biosparge Trailer #2

Trailer #2 (pictured in **Figure 5-20**) is electrically wired for an explosion proof atmosphere. The trailer consists of a propane feed system, air/propane distribution system, and a soil vapor extraction (SVE) system (the SVE system was not utilized during this demonstration).

The propane feed system consists of an external propane cylinder with regulator that transfers propane to the air/propane distribution system through a pressure switch to redundant solenoid control valves, through a flow indicator with a switch and ball valve. The propane joins the air feed downstream of its pair of check valves. The Propane Injection Panel Assembly is intrinsically safe and in full compliance with the LP-Gas Code, with barriers inside the main control panel.

Propane gas was supplied by a 95 pound external propane cylinder that was secured within a vertical, metal gas storage cabinet immediately adjacent to Trailer #2. The cylinder was properly grounded and concrete barriers installed around the trailer for protection from vehicles. A gas pressure regulator and excess flow valve was installed on the cylinder. The excess flow valve automatically shuts off delivery of propane if it exceeds a preset limit (i.e. in the event of a leak or system malfunction). Appropriate tubing was used between the excess flow valve and the propane gas connection on the trailer.

The air/propane distribution system in Trailer #2 includes dual check valves to prevent back flow of the air propane mixture, a Lower Explosive Level (LEL) sampling system, pressure gauges, and a backpressure regulator. The system is designed to feed propane below the LEL (2.1%) and will automatically shut down in the event the LEL is exceeded. Propane feed concentrations for this demonstration were generally between 30 and 40 percent of the LEL (between 0.63 and 0.84 percent propane). The air/propane mixture is manifolded between five (5) discharge points that include flow indicators with needle valves. The LEL sampling system diverts a minor flow from the air/propane mixture to an LEL analyzer with flow cell. The sample is filtered and monitored for adequate flow via two indicators and a flow switch. The sample will discharge to the

atmosphere through tubing that passes through the wall of the trailer. An air discharge permit is not required, as the mass of propane discharged daily has been calculated at approximately 0.07 lbs/day, well below the 2 lb/day limit.

**Figure 5-18. Photograph of biosparge trailer units.**



**Figure 5-19. Inside of Trailer #1 which houses the controls and air supply system.**





**Figure 5-20. Inside of Trailer # 2, which houses the propane feed and distribution as well as SVE equipment.**



#### **5.4.4 Biosparging System Installation and Testing**

The two mobile trailers containing the biosparging system were transported from CB&I's Findlay, OH shop to the Aerojet site via a flat-bed tractor trailer. Upon arrival, the trailers were situated on a level surface so that the inter-trailer electrical connections were within 10 ft of each other. Wheel chocks were placed securely around all trailer tires to prevent rolling, and the trailers were leveled using their landing legs. Jack stands were placed under the rear of the trailers for additional stability.

Once the trailers were secure, fittings that were loosened for transport were reconnected. The inter-trailer airlines were then connected, and three 1" polypropylene hoses (rated for 100 psi) were connected from the three air/propane discharge points on Trailer #2 to the wellheads on the biosparging wells.

Propane cylinders, each containing 95 lbs of 99% chemically pure propane were delivered to the site by a local gas vendor and secured within the vertical, metal gas cylinder storage cabinet immediately adjacent to Trailer #2. The cylinders were properly grounded and concrete barriers were installed around the trailer for protection from vehicles. A gas pressure regulator was installed on a single cylinder, with spare cylinders kept in reserve. An excess flow shut-off valve, designed to automatically shut off the delivery of gas if it exceeds a preset limit, was also installed downstream of the regulator to prevent release of propane gas to the atmosphere or within the trailer in the event of a leak. Appropriate tubing was installed between the excess flow valve and the propane gas connection on the trailer.

A 100 Amp, 220 VAC, single phase power connection was made between the electrical junction box on external front side of Trailer #1 and junction box run from a power pole near the demonstration site. The power drop at the utility pole was performed by an Aerojet electrician. A wireless communication system was installed and connected to the Main Control panel and autodialer. The inter-trailer power and control cables were connected between receptacles on Trailers #1 & #2 to complete electrical connections.

Upon completion, the system was fully tested for operation and functionality. The injection hoses to the biosparging wells were temporarily removed, and the system was operated through several on-off cycles. The proper operation of the LEL meter, solenoid valves, flow meters, pressure switches, regulators, as well as other equipment, was confirmed. The system was tested for any leaks that may have occurred during transport. Once testing was complete, the injection hoses were re-attached to the sparging wells.

## 5.5 FIELD TESTING

A timeline of system operation is provided as **Table 5-6**. The biosparging system was operated for a period of 374 days from start-up to shut-down. The operation entailed automated injections of air and propane into the TPA biosparging wells. Inorganic nutrients were not added. As described in **Section 5.4.3**, propane was fed into the air stream in Trailer #2, prior to being injected into the biosparging wells. With the exception of the first few weeks after start-up, propane feed concentrations were generally between 30% and 40% of the LEL (between ~ 0.63 and 0.84 percent propane; **Table 5-6**). The flow, divided evenly between the biosparging wells, was generally between 5 and 6 SCFM, and daily cycles varied from 30 to 50 minutes in length and 2-12 times daily. Operational details are provided in the subsequent subsections.

During the active testing period (after background sampling and during active gas flow), groundwater samples were collected and analyzed for NDMA, VOCs, propane, dissolved oxygen, anions, dissolved Fe and Mn, total propanotrophic bacteria (select sampling events), and basic field parameters [temperature, pH, specific conductivity, dissolved oxygen (DO), and oxidation-reduction potential (ORP)] as detailed in **Section 5.6**. A total of thirteen groundwater sampling events (including two baseline sampling events and two rebound sampling events) were conducted during the demonstration.

### 5.5.1 System Start-Up and Monitoring

Once system installation and testing were complete, two baseline groundwater sampling events that included all seven demonstration monitoring wells were performed prior to initiating biosparging. These events were conducted on Day -84 and Day -70 relative to system start-up at Day 0 (2/13/2012; **Table 5-6**). During start-up, it was determined that the pressure in the installed biosparging wells was too high for system operation, and with the exception of BW-4, gas flow into the aquifer did not occur at pressures as high as 60 psi. This issue, which related to the type of specialized sparging screens used during well installation, was discussed previously in **Section 5.4.1**. During the initial 4 months of operation, air and propane were sparged through well PMW-1, a monitoring well that was converted to a combined biosparging/monitoring well.

Well BW-4 was also used for biosparging for a few weeks, until gas flow in this well ceased. After 4 months of operation, it was determined that gas distribution was not sufficient with PMW-1 as the sole biosparging well, and two additional wells (BW-6 and BW-7) were added to the TPA (Day 126 – 130). From this point forward, gas was sparged through all three wells. There were no additional issues with sparge pressures or gas flow after this point.

### 5.5.2 System Operation & Performance Monitoring

The biosparging system was operated for a period of 374 days from start-up to shut-down. As noted, PMW-1 was operated as the sole sparging well for the first 4 months of operation (with the exception of the first few weeks when BW-4 was also operating), and then wells BW-6, BW-7, and PMW-1 were operated together for the remaining 8.3 months of operation. The operational data are provided in **Table 5-6**. The variables that were adjusted and optimized throughout the demonstration included (1) the average LEL reading (measure of percentage propane in the air-propane feed); (2) the length of the sparging cycles; (3) the number of sparging cycles per day; and (4) the breakdown of the sparge cycle, which was composed of an initial air sparge, and period of combined air-propane sparging, and then a final air sparge to clear the sparge lines of propane gas. These variables were modified during the demonstration (as described below and in **Table 5-6**) based upon the levels of propane and NDMA observed during sampling events and during propane degradation testing.

The percent propane in the sparge gas was increased over the first few months of the demonstration, and eventually set at 40% of the LEL on Day 131, which equated to ~ 0.84% propane in the feed gas. The setting remained at this level through Day 374, when the sparge system was shut down. Similarly, the number of cycles per day was increased from 6 to 8 on Day 89, and then further to 12 on Day 217 through the end of operation on Day 374. The amount of time that propane was sparged to each of the wells per cycle was increased from 20 minutes to 26 minutes on Day 89, decreased slightly to 24 minutes on Day 134, and then increased to 40 minutes on Day 217 for the remainder of the 374-day sparging period. The amount of propane added to the TPA (1.83 lbs/day) was considered optimized on Day 217, and generally remained the same thereafter for the remaining 5 months of active sparging.

Full rounds of groundwater sampling were conducted on 13 occasions as shown on **Table 5-6**. This included two baseline sampling rounds on Day -84 and -70, nine performance sampling events during active sparging (Days 42, 84, 161, 185, 213, 241, 287, 311, and 353) and two rebound events after biosparging ceased (Day 385 and 430). Sampling generally consisted of 7 wells (PMW-1 to PMW-6 and BMW-1; **Figure 5-16**). An additional round of baseline sampling of all wells (excluding PMW-6) for propanotrophs was also conducted on Day -6. For the final three sampling events, Wells BW-6 and BW-7 were also sampled. The sampling protocol and list of analytes are described in **Section 5.6**.

The SCADA system connected to the PLC that controlled the biosparging system collected and stored readings of total system flow and LEL every 3 minutes. The wireless communications system connected to the SCADA allowed for remote access to the system, and downloading of the operational data. A system check form was completed when on-site field technicians evaluated system operation. An example of the form, which included air sparge and propane injection system flows and pressures, is provided in **Figure 5-21**. Any system modifications were also documented on this form.

### **5.5.3 System Shutdown and Demobilization**

The biosparging system was shut down on Day 374. The two biosparging trailers, along with the propane cylinders and all above ground equipment were subsequently removed from the site. All biosparging and monitoring wells were abandoned according to California regulations on Day 520. All surface completions were removed, the well casing cut approximately 1 foot bgs, and the wells were filled with cement bentonite grout. Well destruction reports are provided in **Appendix C** after the well boring logs.

**Table 5-6. Timeline of Sampling and System Operation.**

| Date       | Duration | Day | Activity  | Operational Wells |      |      |      | Average Total Flow (SCFM) | Average LEL Reading (percent) | No. of Cycles per Day | Cycle length (minutes) | Propane Cycle (minutes) | Cycle Breakdown (minutes)  | Comments   |
|------------|----------|-----|---|-------------------|------|------|------|---------------------------|-------------------------------|-----------------------|------------------------|-------------------------|--|--|
|            |          |     |   | PMW-1             | BW-4 | BW-6 | BW-7 |                           |                               |                       |                        |                         |  |  |
| 11/21/2011 | 1 day    | -84 | Baseline Sampling Event #1  |                   |      |      |      |                           |                               |                       |                        |                         | 7 wells: NDMA, anions, dissolved gases   |  |
| 12/5/2011  | 1 day    | -70 | Baseline Sampling Event #2  |                   |      |      |      |                           |                               |                       |                        |                         | 7 wells: NDMA, anions, dissolved gases   |  |
| 2/7/2012   | 1 day    | -6  | Baseline Sampling Event (propanotrophs)                             |                   |      |      |      |                           |                               |                       |                        |                         | 6 wells for total propanotrophs  |  |
| 2/8/2012   | 1 day    | -5  | Dissolved oxygen and propane distribution sampling (system testing) |                   |      |      |      |                           |                               |                       |                        |                         | Select wells sampled for field param & dissolved gases to determine gas distribution during system testing |  |
| 2/9/2012   | 1 day    | -4  | Dissolved oxygen and propane distribution sampling (system testing) |                   |      |      |      |                           |                               |                       |                        |                         | Select wells sampled for field param & dissolved gases to determine gas distribution during system testing |  |
| 2/13/2012  | 3 days   | 0   | System startup & testing  | X                 | X    |      |      | 5                         | 2                             | 2                     | 50                     | 30                      | 10-30-10   |  |
| 2/16/2012  | 15 days  | 3   | Normal operation  | X                 | X    |      |      | 5                         | 5                             | 2                     | 30                     | 20                      | 5-20-5   | Having problems with propane condensation at night due to low temperature and high pressure required to sparge at BW-4 |
| 3/2/2012   | 22 days  | 18  | Restart operation: PMW-1 only, 2 cycles per day                     | X                 |      |      |      | 5                         | 30                            | 2                     | 30                     | 20                      | 5-20-5   | BW-4 no longer operational, sparging at PMW-1 only   |
| 3/24/2012  | 41 days  | 40  | Normal operation: 3 cycles during day-none at night                 | X                 |      |      |      | 5                         | 30                            | 3                     | 35                     | 20                      | 10-20-5  | Intermittent problems with propane flow, due to cold temp - correct with heat tape and insulation                      |
| 3/26/2012  | 1 day    | 42  | Performance Sampling Event #1                                       |                   |      |      |      |                           |                               |                       |                        |                         |  | 7 wells: NDMA, anions, dissolved gases   |
| 5/4/2012   | 8 days   | 81  | Normal operation: 6 cycles per day                                  | X                 |      |      |      | 5                         | 35                            | 6                     | 35                     | 20                      | 10-20-5  | Increase to 6 cycles per day   |
| 5/7/2012   | 1 day    | 84  | Performance Sampling Event #2                                       |                   |      |      |      |                           |                               |                       |                        |                         |  | 7 wells: NDMA, anions, dissolved gases, total propanotrophs  |
| 5/12/2012  | 131 days | 89  | Normal operation: 8 cycles per day                                  | X                 |      |      |      | 6                         | 40                            | 8                     | 32                     | 26                      | 2-26-4   | Increase to 8 cycles per day   |
| 6/4/2012   | 1 day    | 112 | Propane distribution sampling                                       |                   |      |      |      |                           |                               |                       |                        |                         |  | 5 wells for dissolved gases PMW-1 for NDMA.  |
| 6/18/2012  | 4 days   | 126 | Installed new sparge wells BW-6 and BW-7                            |                   |      |      |      |                           |                               |                       |                        |                         |  |  |
| 6/26/2012  | 83 days  | 134 | Normal operation: 3 wells, 8 cycles per day                         | X                 |      | X    | X    | 6                         | 40                            | 8                     | 34                     | 24                      | 4-24-6   |  |
| 7/23/2012  | 1 day    | 161 | Performance Sampling Event #3                                       |                   |      |      |      |                           |                               |                       |                        |                         |  | 7 wells: NDMA, anions, dissolved gases   |
| 8/16/2012  | 1 day    | 185 | Performance Sampling Event #4                                       |                   |      |      |      |                           |                               |                       |                        |                         |  | 7 wells: NDMA, anions, dissolved gases   |
| 9/13/2012  | 1 day    | 213 | Performance Sampling Event #5                                       |                   |      |      |      |                           |                               |                       |                        |                         |  | 7 wells: NDMA, anions, dissolved gases, total propanotrophs  |
| 9/17/2012  | 157 days | 217 | Normal operation: 3 wells, 12 cycles per day                        | X                 |      | X    | X    | 6                         | 40                            | 12                    | 48                     | 40                      | 4-40-4   | Increased to 12 cycles per day   |
| 10/1/2012  | 1 day    | 231 | Propane degradation test  |                   |      |      |      |                           |                               |                       |                        |                         |  | PMW-3 & PMW-4. Two sparge cycles.  |
| 10/11/2012 | 1 day    | 241 | Performance Sampling Event #6                                       |                   |      |      |      |                           |                               |                       |                        |                         |  | 7 wells: NDMA, anions, dissolved gases   |
| 11/26/2012 | 1 day    | 287 | Performance Sampling Event #7                                       |                   |      |      |      |                           |                               |                       |                        |                         |  | 7 wells: NDMA, anions, dissolved gases   |
| 12/20/2012 | 1 day    | 311 | Performance Sampling Event #8                                       |                   |      |      |      |                           |                               |                       |                        |                         |  | 7 wells: NDMA, anions, dissolved gases, total propanotrophs  |
| 1/31/2013  | 1 day    | 353 | Performance Sampling Event #9                                       |                   |      |      |      |                           |                               |                       |                        |                         |  | 9 wells: NDMA, anions, dissolved gases   |
| 2/21/2013  | 1 day    | 374 | System shutdown   |                   |      |      |      |                           |                               |                       |                        |                         |  | all gas flow shut down   |
| 3/4/2013   | 1 day    | 385 | Rebound Sampling Event #1   |                   |      |      |      |                           |                               |                       |                        |                         |  | 9 wells: NDMA, anions, dissolved gases   |
| 4/18/2013  | 1 day    | 430 | Rebound Sampling Event #2   |                   |      |      |      |                           |                               |                       |                        |                         |  | 9 wells: NDMA, anions, dissolved gases, total propanotrophs  |
| 7/17/2013  | 2 days   | 520 | Well abandonment  |                   |      |      |      |                           |                               |                       |                        |                         |  |  |

Figure 5-21. System check form used to document system settings and pressures.

**SYSTEMS CHECK FORM**  
**ESTCP PROJECT: IN SITU REMEDIATION OF NDMA IN GROUNDWATER**  
**AEROJET FACILITY**  
**RANCHO CORDOVA, CA**  
**Shaw Project No: 133317**

Inspector: Adam Norvelle System In Sparge Mode?: Y / N  
 Date: 12-5-12 Sparge Cycle Start Time: 1000  
 Sparge Wells: PMW-1, BW-6, BW-7 Sparge Cycle Stop Time: 1049

**AIR SPARGE SYSTEM FLOWS AND PRESSURES**

| Initial Readings   | Changes Made? Y / N | Adjusted Readings (if applicable)               |
|--|---------------------|---|
| Mass Flow Meter Reading (FM-1): <u>7.52</u> SCFM                             |                     | Mass Flow Meter Reading (FM-1): _____ SCFM      |
| BW-7 Rotometer Reading (FM-2): <u>1.3</u> SCFM                               |                     | BW-4 Rotometer Reading (FM-2): _____ SCFM       |
| BW-7 Well Head Pressure: <u>30</u> psi                                       |                     | BW-4 Well Head Pressure: _____ psi              |
| BW-7 Corrected Flow: <u>—</u> SCFM   |                     | BW-4 Corrected Flow: _____ SCFM                 |
| PMW-1 Rotometer Reading (FM-3): <u>70</u> SCFM <sup>H</sup>                  |                     | PMW-1 Rotometer Reading (FM-3): _____ SCFM      |
| PMW-1 Well Head Pressure: <u>—</u> psi                                       |                     | PMW-1 Well Head Pressure: _____ psi             |
| PMW-1 Corrected Flow: <u>—</u> SCFM  |                     | PMW-1 Corrected Flow: _____ SCFM                |
| Air Compressor Reading (PI-1): <u>90</u> psi                                 |                     | Air Compressor Reading (PI-1): _____ psi        |
| Pressure Regulator #1 Reading (PI-2): <u>48</u> psi                          |                     | Pressure Regulator #1 Reading (PI-2): _____ psi |
| Pressure Regulator #2 Reading (PI-3): <u>0</u> psi                           |                     | Pressure Regulator #2 Reading (PI-3): _____ psi |
| Pressure Regulator Rotometer (FM-4): <u>0</u> <sup>SCFH</sup> <sub>lpm</sub> |                     | Pressure Regulator Rotometer (FM-4): _____ lpm  |
| Air Delivery Pressure #1 (PI-4): <u>38</u> psi                               |                     | Air Delivery Pressure #1 (PI-4): _____ psi      |
| Air Delivery Pressure #2 (PI-5): <u>37</u> psi                               |                     | Air Delivery Pressure #2 (PI-5): _____ psi      |

BW-6 Rotometer 70 SCFH  
BW-6 Well Head 31 PSI

**PROPANE INJECTION SYSTEM FLOWS AND PRESSURES**

| Initial Readings   | Changes Made? Y / N | Adjusted Readings (if applicable)              |
|--|---------------------|--|
| Tank Pressure: <u>—</u> psi  |                     | Tank Pressure: _____ psi                       |
| Delivery Pressure: <u>50</u> psi   |                     | Delivery Pressure: _____ psi                   |
| Observed Gas Flow: <u>1.2</u> lbs/day  |                     | Observed Gas Flow: _____ lbs/day               |
| LEL reading: <u>39.2</u> percent   |                     | LEL reading: _____ percent                     |
| LEL Meter Pressure (PI-6): <u>1.3</u> psi                                      |                     | LEL Meter Pressure (PI-6): _____ psi           |
| LEL Sample Flow Rotometer #1 (FM-5): <u>0.6</u> <sup>SCFH</sup> <sub>lpm</sub> |                     | LEL Sample Flow Rotometer #1 (FM-5): _____ lpm |
| LEL Sample Flow Rotometer #2 (FM-6): <u>1.3</u> <sup>SCFH</sup> <sub>lpm</sub> |                     | LEL Sample Flow Rotometer #2 (FM-6): _____ lpm |

Before Needle Valve 54 PSI  
After Needle Valve 37 PSI

Comments: Cracked "T" joint removed from PMW-1 well head - replaced with straight hose connection.

## 5.6 SAMPLING METHODS

### 5.6.1 Groundwater Sampling and Analysis

Groundwater samples were collected by CB&I personnel utilizing low-flow purging in accordance with EPA Low-Flow Ground-Water Sampling Procedures (Puls and Barcelona, 1996). Samples were obtained from each monitoring well using a dedicated submersible bladder pump and Teflon tubing, and a flow-through cell with a YSI field meter (or equivalent) to allow measurement of field geochemical parameters (pH, ORP, temperature, specific conductivity, and dissolved oxygen). All field meters were calibrated at the beginning of each day. The submersible bladder pumps and tubing used to sample all wells was dedicated and therefore did not require decontamination. Each pump was set at mid-screen depth within each monitoring well.

Groundwater samples were analyzed for basic field parameters, NDMA (EPA Method 521), VOCs (EPA Method 8260), dissolved gases (methane, propane, ethane, ethene via EPA 3810, RSK175), and anions (EPA 300.0) as detailed in **Table 5-7**. VOC sampling only occurred during the baseline sampling events since no compounds were detected by EPA 8260. Total propanotrophic bacteria were quantified during one baseline event prior to gas injection to establish background levels and four of the monthly events thereafter using qPCR (see **Table 5-6**). The analysis of VOCs, anions, and dissolved gases was performed by CB&I's Analytical Laboratory in Lawrenceville, NJ. Total propanotrophs were quantified by qPCR at Microbial Insights (Knoxville, TN). Analysis of NDMA was performed by Weck Laboratories, City of Industry, CA. Weck Laboratories is a California Department of Public Health approved lab and is listed under the State of California Environmental Laboratory Accreditation Program (ELAP). The MDL for NDMA by this method is typically 2 ng/L but can be higher in some instances due to sample turbidity or other factors.

Prior to each sampling event, groundwater elevation measurements were collected using an electronic water level indicator. Measurements were obtained from the top-of-casing and recorded to the nearest 0.01-ft. Groundwater elevation data was used to determine water table elevations and hydraulic gradient within the demonstration area.

**Table 5-7. Analytical Methods for the Demonstration.**

| Analyte <sup>1</sup> | Method/<br>Laboratory                | Preservative                | Bottle  | Hold time   |
|----------------------|--------------------------------------|-----------------------------|---|---|
| NDMA                 | EPA 521/Weck                         | 4°C with sodium thiosulfate | 500 mL glass screw-cap x 2. Bottles provided by Weck Laboratory | 14 days (extraction)<br>28 days (extract)                         |
| VOCs                 | EPA 8260/CB&I                        | 4°C with HCl                | 40 mL VOA vial x2. No headspace                                 | 14 days   |
| Anions               | EPA 300.0/CB&I                       | 4°C                         | 100 mL polyethylene screw-cap                                   | 2 days (NO <sub>3</sub> , PO <sub>4</sub> );<br>28 days all other |
| Total Propanotrophs  | qPCR/Microbial Insights <sup>2</sup> | 4°C                         | 950 mL sterile screw-cap bottle                                 | NA <sup>3</sup>   |
| Dissolved Gases      | EPA 3810, RSK175/CB&I <sup>2</sup>   | 4°C with HCl                | 40 mL VOA vial x 2. No headspace                                | 14 days   |
| Redox Potential      | Field Meter                          | --                          | --  | NA  |
| Dissolved Oxygen     | Field Meter                          | --                          | --  | NA  |
| pH                   | Field Meter                          | --                          | --  | NA  |
| Conductivity         | Field Meter                          | --                          | --  | NA  |

<sup>1</sup>All analyses are in groundwater <sup>2</sup>Not a standard EPA Method. <sup>3</sup>NA = Not applicable

### 5.6.2 Numbers and Types of Samples Collected

The numbers and types of groundwater samples collected are provided in **Table 5-8**. During site characterization activities, 4 bromide sampling events were performed at 4 wells (PMW-1 through PMW-4) as part of a bromide tracer test that occurred over ~ 1 month (See **Section 5.2.9**). Two rounds of baseline groundwater sampling were conducted from the 7 monitoring wells in the TPA (PMW-1 through PMW-6 and BMW-1) on Days -84 and -70 before system start-up (Day 0). Six wells were sampled on Day -6 to quantify baseline propanotroph numbers. There were 9 rounds of sampling conducted during biosparging that included all 7 performance monitoring wells (from Day 42 to Day 353 after start-up). Biosparge wells BW-6 and BW-7 were also sampled on Days 133 (after installation), 311, and 353. Samples for total propanotrophs were collected during three sampling rounds (Day 84, 213, and 353). Samples were collected from 5 wells (PMW-1 to PMW-5) on Day 112 after a sparge cycle to evaluate propane distribution in the TPA during biosparging at PMW-1. A propane degradation test was conducted on Day 231 after system optimization to evaluate the propane concentrations in groundwater during biosparge cycles and the rate at which the propane was consumed by indigenous bacteria. Finally, two rebound sampling rounds were conducted after the biosparging system was shut down on Day 353 (Days 385 and 430). In addition to the 7 wells typically sampled during the performance monitoring event, samples were collected from biosparging wells BW-6 and BW-7 during these events.



**Table 5-8. Total Number and Types of Samples Collected During the Demonstration.**

| Event                           | Occurrence  | Number of Samples | Analyte   | Location   |
|---------------------------------|---|-------------------|---|--|
| Bromide Tracer Testing          | 6 Events (Days -229, -227, -223, -217, -202, -200,  | 24                | Anions (bromide)                                      | 4 Wells (PMW-1 through PMW-4)  |
| Background Sampling             | 2 Events (Day-84, and -70)  | 14                | NDMA, VOCs, anions, dissolved gases, field parameters | 7 Wells. All performance monitoring wells (PMW-1 through PMW-6); background well (BMW-1)   |
|                                 | 1 Events (Day -6)   | 6                 | Total propanotrophs                                   | 6 Wells. Performance monitoring wells (PMW-1 through PMW-5); background well (BMW-1) and   |
| Technology Performance Sampling | 9 Events (42, 84, 161, 185, 213, 241, 287, 311, 353)<br>1Event Day 133 for BW-6 and BW-7 only | 64                | NDMA, anions, dissolved gases, field parameters       | 7 Wells. All performance monitoring wells (PMW-1 through PMW-6); background well (BMW-1) and wells BW-6, BW-7 (Day 133, 311, 353 only) |
|                                 | 3 Events (Day 84, 213, 311 )  | 18                | Total propanotrophs                                   | 6 Wells. Performance monitoring wells (PMW-1 through PMW-5); background well (BMW-1)   |
| Propane Distribution Sampling   | 1 Event (112)   | 5                 | Dissolved gases (propane)                             | PMW-1 through PMW-5 after sparge cycle   |
|                                 | 1 Event (231)   | 46                | Dissolved gases (propane)                             | PMW-3 and PMW-4 23 samples each through through two sparge cycles  |
| Rebound Sampling                | 2 Events (Day 385, and 430)   | 18                | NDMA, anions, dissolved gases, field parameters       | 9 Wells. All performance monitoring wells (PMW-1 through PMW-6); background well (BMW-1); Biosparge wells BW-6, BW-7                   |
|                                 | 1 Event (Day 430)   | 6                 | Total propanotrophs                                   | 6 Wells. Performance monitoring wells (PMW-1 through PMW-5); background well (BMW-1)   |

### 5.6.3 Quality Assurance for Groundwater Sampling and Analysis

**Calibration Procedures and Frequency.** Calibration refers to the checking of physical measurements of both field and laboratory instruments against accepted standards. It also refers to determining the response function for an analytical instrument, which is the measured net signal as a function of the given analyte concentration. These determinations have a significant impact on data quality and are performed regularly. In addition, preventative maintenance is important to the efficient collection of data. The calibration policies and procedures set forth apply to all test and measuring equipment. For preventative maintenance purposes, critical spare parts are obtained from the instrument manufacturer.

All field and laboratory instruments were calibrated according to manufacturers' specifications. All CB&I laboratory instruments were calibrated in accordance with established Standard Operating Procedures. Calibration was performed prior to initial use and after periods of non-use. A logbook is maintained by CB&I laboratory QA personnel similarly for laboratory instrumentation.

**Field Measurements: Groundwater.** Groundwater was assessed for dissolved oxygen, pH, temperature, oxidation/reduction potential, and conductivity with a field meter. Depth to groundwater measurements were taken using a water interface probe.

#### Dissolved Oxygen, Temperature, pH, Conductivity and Oxidation/Reduction Potential:

Prior to sampling, the well or sampling point identification was checked and recorded along with the date and time on the field sampling sheet. Groundwater samples were collected using bladder pumps connected to a compressor via a pump-specific controller. Samples were measured for dissolved oxygen, temperature, pH, conductivity and redox potential using a multi-probe water quality meter (e.g., YSI Model 6920, or similar). In order to minimize aeration of the sample, a continuous flow-through cell was used to provide a sampling chamber for the meter. A sufficient volume of water from the well or groundwater sampling point was purged before sample collection to ensure that a sample representative of the formation is obtained based on standard low-flow procedures (Puls and Barcelona, 1996). A field sheet was prepared for each well to document standardization of parameters prior to sampling. A representative field sheet is provided in **Figure 5-22**.

#### Depth to Groundwater:

The depth to groundwater in site wells was measured with a water interface probe (Solinst Model #101, or equivalent). The probe lead is a 100- to 200-ft measuring tape with 0.01-ft increments. The probe gives a constant beep when it encounters the water table. The water-level measurements were recorded on each field sheet and the probe was decontaminated between wells.

**Laboratory Measurements.** The calibration procedures for all off-site analyses followed the established SW-846 and US EPA guidelines for the specific methods. Certified standards were used for all calibrations and calibration check measurements.

Figure 5-22. Example groundwater parameter stabilization form.

**LOW FLOW GROUNDWATER SAMPLING DATA SHEET**  
**ESTCP PROJECT: IN SITU REMEDIATION OF NDMA IN GROUNDWATER**  
**Asset Facility: Ramoth Gardens, GA**  
**Asset Project No. 200877**

WELL ID: PMW-3      Sampling Date: 5-7-11  
 Well Depth (ft): \_\_\_\_\_      Sampler(s): Paul Wankner  
 Depth to Water Prior to Purging (ft): 6.50      Sampling Device: Reverse Pump  
 Well Casing Diameter (in): 2"      Weather Conditions: Sunny  
 Start Time (purging): 7:45

**FIELD PARAMETERS**

| Time (hh:mm) | pH   | Temperature (°F) | Dissolved Oxygen (mg/L) | Redox Potential (mV) | Specific Conductance (µmhos/cm) | Depth To Water (ft) | Volume Pumped (gallons) | Approximate Purge Rate (gpm) |
|--------------|------|------------------|-------------------------|----------------------|---------------------------------|---------------------|-------------------------|------------------------------|
| 7:45         | 6.25 | 15.40°           | 14.35                   | 2147                 | 469                             | 6.50                | -                       | ~250 gpm                     |
| 7:50         | 6.73 | 15.42°           | 14.58                   | 2156                 | 466                             | 6.72                | 1250"                   | ↓                            |
| 7:55         | 6.65 | 15.46°           | 15.93                   | 220.8                | 458                             | 6.83                | 2500"                   | ↓                            |
| 8:00         | 6.61 | 15.32°           | 17.81                   | 2271                 | 453                             | 6.83                | 3150"                   | 150 gpm                      |
| 8:05         | 6.61 | 15.30°           | 18.00°                  | 2279                 | 452                             | 6.83                | 3900"                   | ↓                            |
| 8:10         | 6.61 | 15.30°           | 18.01°                  | 2324                 | 452                             | 6.83                | 4650"                   | ↓                            |
| 8:15         | 6.60 | 15.34°           | 18.20°                  | 2331                 | 450                             | 6.85                | 5400"                   | ↓                            |
|              |      |                  |                         |                      |                                 |                     |                         |                              |
|              |      |                  |                         |                      |                                 |                     |                         |                              |
|              |      |                  |                         |                      |                                 |                     |                         |                              |
|              |      |                  |                         |                      |                                 |                     |                         |                              |
|              |      |                  |                         |                      |                                 |                     |                         |                              |
|              |      |                  |                         |                      |                                 |                     |                         |                              |
|              |      |                  |                         |                      |                                 |                     |                         |                              |
|              |      |                  |                         |                      |                                 |                     |                         |                              |
|              |      |                  |                         |                      |                                 |                     |                         |                              |
|              |      |                  |                         |                      |                                 |                     |                         |                              |
|              |      |                  |                         |                      |                                 |                     |                         |                              |
|              |      |                  |                         |                      |                                 |                     |                         |                              |
|              |      |                  |                         |                      |                                 |                     |                         |                              |
|              |      |                  |                         |                      |                                 |                     |                         |                              |
|              |      |                  |                         |                      |                                 |                     |                         |                              |

Sample Time: 8:20

Analytes Sampled: \_\_\_\_\_

Comments: sampled well AFTER 7:00am injection cycle

\_\_\_\_\_

\_\_\_\_\_

\_\_\_\_\_

**Quality Control Samples.** Internal QC data provides information for identifying and defining qualitative and quantitative limitations associated with measurement data. Analysis of the following types of QC samples provided the primary basis for quantitative evaluation of field data quality:

Field QC Samples:

- trip blanks to evaluate the presence of contamination from handling errors or cross-contamination during transport;
- field duplicates to assess the homogeneity of samples received by the laboratory as well as the homogeneity of contaminants in the matrix.

**Trip Blanks.** Trip blanks were prepared by the analytical laboratory with purified water for groundwater samples. The water was sent to the site in the same containers to be used for collection of the samples. Trip blanks were submitted at a frequency of one trip blank per shipment of samples for VOC analysis. For non-VOC analyses, no trip blanks were deemed necessary and none were submitted.

**Field Duplicate Samples.** Field duplicate samples were analyzed for all parameters to evaluate the accuracy of the analytical process. Duplicate samples were analyzed as described below. Each duplicate was run at a frequency of at least 5 percent of the total number of environmental samples. A comparison of the detected concentrations in the duplicate samples was performed to evaluate precision. The evaluation was conducted using a Relative Percent Difference (RPD) calculation as shown below

$$RPD = (C_1 - C_2) * 100 / ((C_1 + C_2) / 2) \quad \text{(Equation 1)}$$

Where: RPD = relative percent difference

$C_1$  = the larger of the two observed values

$C_2$  = the smaller of the two observed values

**Sample Documentation.** CB&I Lawrenceville, NJ project staff coordinated shipment and receipt of sample bottles, coolers, ice packs, chain-of-custody (COC) forms, and Custody Seals. Upon completion of sampling, the COC was filled out and returned with the samples to the CB&I and Weck laboratories. An electronic copy of each COC form was placed in the project database. An important consideration for the collection of environmental data is the ability to demonstrate that the analytical samples have been obtained from predetermined locations and that they have reached the laboratory without alteration. Evidence of collection, shipment, laboratory receipt, and laboratory custody until disposal must be documented to accomplish this. Documentation was accomplished through a COC Record that recorded each sample and the names of the individuals responsible for sample collection, transport, and receipt. A sample is considered in custody if it is:

- ◆ in a person's actual possession;
- ◆ in view after being in physical possession;

- ◆ sealed so that no one can tamper with it after having been in physical custody; or
- ◆ in a secured area, restricted to authorized personnel.

Sample custody was initiated by field personnel upon collection of samples. Samples were packaged appropriately to prevent breakage or leakage during transport, and shipped to the laboratory via commercial carrier.

**Sample Identification.** A discrete well number was assigned to each sample. This discrete identifier was placed on each bottle and was recorded, along with other pertinent data in a field notebook dedicated to the project. The sample identification number designated the sample location (e.g., “PMW-2” for this specific monitoring well). The bottle label also contained the site “Aerojet”, the sampling date and time, any preservatives added to the bottle, and the initials of the sampler.

**Chain-of Custody Forms.** The COC Record used by CB&I’s laboratory is shown in **Figure 5-23**. All samples collected for off-site analysis were physically inspected by the Field Engineer prior to shipment.

Each individual who had sample in their possession signed the COC Record. Preparation of the COC Record was as follows:

- ◆ The COC Record was initiated in the field by the person collecting the sample, for every sample. Every sample was assigned a unique identification number entered on the COC Record.
- ◆ The record was completed in the field to indicate project, sampling person, etc.
- ◆ If the person collecting the samples did transport the samples to the laboratory or ship the samples directly, the first block for “Relinquished By \_\_\_\_\_, Received By \_\_\_\_\_” was completed in the field.
- ◆ The person transporting the samples to the laboratory or delivering them for shipment signed the record for as “Relinquished By \_\_\_\_\_”.
- ◆ The original COC Record was sealed in a watertight container, taped to the top (inside) of the shipping container, and the shipping container sealed prior to being given to the commercial carrier.

The commercial waybill served as an extension of the COC Record between the final field custodian and receipt by the off-site laboratory.

- Upon receipt by the off-site laboratory, the laboratory QC Coordinator, or designated representative, opened the shipping container(s), compared the contents with the COC Record, and signed and dated the record. Any discrepancies were noted on the COC Record.
- COC Records are maintained with the records for the project, and become part of the data package.

**Laboratory Sample Receipt.** Following sample receipt, the Laboratory Manager or qualified personnel:


- ◆ Examined all samples and determined if proper temperature has been maintained during transport. If samples had been damaged during transport, the remaining samples were carefully examined to determine whether they were affected. Any samples affected were considered damaged. It was noted on the COC record that specific samples were damaged and that the samples were removed from the sampling program.
- ◆ Samples received were compared against those listed on the COC record.
- ◆ It was verified that sample holding times were not exceeded.
- ◆ The COC record was signed and dated.
- ◆ Samples were recorded in the laboratory sample log-in book containing, at a minimum, the following information:
  - Project identification number
  - Sample numbers
  - Type of samples
  - Date and time received.

The COC Record was placed in the project file.

**Other Documentation.** Following sample receipt at the laboratory, the Laboratory Manager or sample custodian clearly documented the processing steps applied to the sample. The analytical data from laboratory QC samples were identified with each batch of related samples. The laboratory log book includes the time, date, and name of the person who logged each sample into the laboratory system. This documentation is thorough enough to allow tracking of the sample analytical history without aid from the analyst. At a minimum, laboratory documentation procedures provide the following:

- ◆ Recording in a clear, comprehensive manner using indelible ink;
- ◆ Corrections to data and logbooks made by drawing a single line through the error and initialing and dating the correction;
- ◆ Consistency before release of analytical results by assembling and cross-checking the information on the sample tags, custody records, bench sheets, personal and instrument logs, and other relevant data to verify that data pertaining to each sample are consistent throughout the record;
- ◆ Observations and results identified with the project number, date, and analyst and reviewer signatures on each line, page, or book as appropriate;
- ◆ Data recorded in bound books or sheaf of numbered pages, instrument tracings or hard copy, or computer hard copy; and,
- ◆ Data tracking through document consolidation and project inventory of accountable documents: sample logbook, analysis data book, daily journal, instrument logbook, narrative and numerical final reports, etc.

Figure 5-23. Chain of Custody (COC) form used by CB&I's laboratory.


 6740000000  
 Laboratory, All States  
 800-850-8500 FAX 800-455-4555  
 www.cb-i.com

**CHAIN OF CUSTODY**

Lab Number: 2600009  
 Page: I of I

Project Number: 133527 / 0109  
 Project Name: PROJECT 1  
 Product Code: 9-7-2  
 Request Date: 9-7-2  
 Lab Location: WV 2  
 Lab Certificate / #s: 62-367-009

Requested By: Steve  
 Requested For: 5-8-2  
 Requested By: [Signature]  
 Requested For: [Signature]

| Lab No. | Sample ID Number | Sample Description | Event | Time  | Date | Initials    | Signature   | Notes |
|---------|------------------|--------------------|-------|-------|------|-------------|-------------|-------|
|         | PM10-1           | lumines            | 9/7   | 13:11 | 9/7  | [Signature] | [Signature] |       |
|         | PM10-2           |                    | 9/7   | 13:11 | 9/7  | [Signature] | [Signature] |       |
|         | PM10-3           |                    | 9/7   | 13:11 | 9/7  | [Signature] | [Signature] |       |
|         | PM10-4           |                    | 9/7   | 13:11 | 9/7  | [Signature] | [Signature] |       |
|         | PM10-5           |                    | 9/7   | 13:11 | 9/7  | [Signature] | [Signature] |       |
|         | PM10-6           |                    | 9/7   | 13:11 | 9/7  | [Signature] | [Signature] |       |
|         | PM10-7           |                    | 9/7   | 13:11 | 9/7  | [Signature] | [Signature] |       |
|         | PM10-8           |                    | 9/7   | 13:11 | 9/7  | [Signature] | [Signature] |       |
|         | PM10-9           |                    | 9/7   | 13:11 | 9/7  | [Signature] | [Signature] |       |
|         | PM10-10          |                    | 9/7   | 13:11 | 9/7  | [Signature] | [Signature] |       |
|         | PM10-11          |                    | 9/7   | 13:11 | 9/7  | [Signature] | [Signature] |       |
|         | PM10-12          |                    | 9/7   | 13:11 | 9/7  | [Signature] | [Signature] |       |
|         | PM10-13          |                    | 9/7   | 13:11 | 9/7  | [Signature] | [Signature] |       |
|         | PM10-14          |                    | 9/7   | 13:11 | 9/7  | [Signature] | [Signature] |       |
|         | PM10-15          |                    | 9/7   | 13:11 | 9/7  | [Signature] | [Signature] |       |
|         | PM10-16          |                    | 9/7   | 13:11 | 9/7  | [Signature] | [Signature] |       |
|         | PM10-17          |                    | 9/7   | 13:11 | 9/7  | [Signature] | [Signature] |       |
|         | PM10-18          |                    | 9/7   | 13:11 | 9/7  | [Signature] | [Signature] |       |
|         | PM10-19          |                    | 9/7   | 13:11 | 9/7  | [Signature] | [Signature] |       |
|         | PM10-20          |                    | 9/7   | 13:11 | 9/7  | [Signature] | [Signature] |       |
|         | PM10-21          |                    | 9/7   | 13:11 | 9/7  | [Signature] | [Signature] |       |

Special Instructions: None  
 Requested By: Steve  
 Requested For: 5-8-2  
 Requested By: [Signature]  
 Requested For: [Signature]

Analytical Method: ADMA  
 Test Method: ADMA  
 Test Method: ADMA

## 5.7 SAMPLING RESULTS

The results for the each well for each parameter are provided in **Appendix B** on a well-by-well basis. These results are summarized in subsequent subsections.

### 5.7.1 NDMA

To evaluate effectiveness, NDMA concentrations in groundwater were monitored in a series of performance monitoring wells (PMWs), four of which (PMW-1, PMW-2, PMW-3, PMW-4) were within or slightly downgradient of the expected zone of influence of the biosparge wells (BW-6, BW-7, PMW-1) (**Figure 3-1**). It should be noted that PMW-1 was used as both a biosparge well and a performance monitoring well throughout the demonstration. Wells PMW-5 and PMW-6 were downgradient of the plot and expected to be influenced later in the demonstration, as treated water reached this region. Well BMW-1, which was side-gradient (~ 75 ft west of the center of the biosparge zone; **Figure 3-1**), was used as a control well to monitor NDMA concentrations outside of the treatment zone.

Two rounds of groundwater samples were collected from all performance monitoring wells prior to initiating propane and oxygen gas addition (Day -70 and Day -84), and nine additional rounds were conducted between Day 0 and Day 353 when propane biosparging was occurring (see **Table 5-6**). Two additional rounds of sampling occurred to evaluate rebound after the system was shut down on Day 373 (Day 385, Day 430). From baseline sampling (average concentrations from Day -70 and Day -84) to the final day sampling during active biosparging (Day 353), concentrations of NDMA declined by 99.7% to > 99.9% in the four PMWs within the zone of influence of the biosparge system (**Figure 5-24** and **Appendix B**). Baseline concentrations of NDMA, which averaged  $25,000 \pm 6000$  ng/L (7 TPA monitoring wells, two baseline events) declined to between 2.7 and 72 ng/L by Day 353 (mean value  $40 \pm 30$  ng/L). The NDMA concentration in well PMW-2 was below 3 ng/L on Day 353. By comparison, the NDMA concentration in the sidegradient control well (BMW-1) averaged 36,000 ng/L during baseline sampling and was 31,000 ng/L on Day 353, a decline of only 14%. Concentrations of NDMA in the far downgradient wells PMW-5 and PMW-6 began to show measurable declines near the end of the demonstration (including after the biosparging system was shut down), presumably as clean water from the biosparge plot began to reach this region of the aquifer. NDMA in PMW-5 declined to 5,400 ng/L on Day 430 (from an initial average of 26,000 ng/L) and NDMA in PMW-6 fell to 13,000 ng/L on Day 430 (from an initial average of 22,500 ng/L).

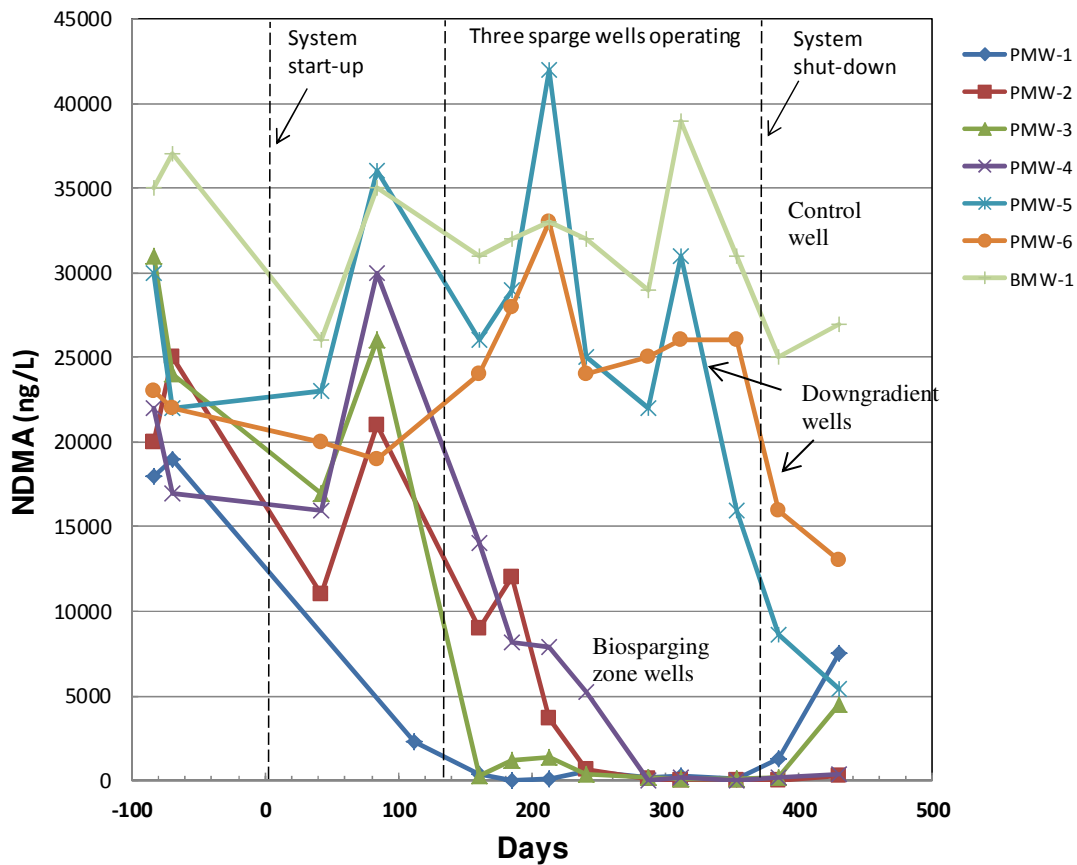
After the system was shut down on Day 373, increases in NDMA were observed in all four of the PMWs within the zone of influence of the biosparge well (**Figure 5-24**). This is consistent with a supply of propane gas being necessary for continued *in situ* biodegradation of NDMA in the aquifer.

The concentration of NDMA was also measured in biosparging wells BW-6 and BW-7 on Days 133 (immediately after installation), and on Days 311, 353, 385, and 430. As observed with the system monitoring wells, NDMA declined significantly in each of these wells (**Appendix B**). NDMA in BW-6 declined from 25,000 ng/L on Day 133 to 5 ng/L on Day 353, and then rebounded after system shut-down to 340 ng/L on Day 430. NDMA in BW-7 declined more slowly, falling from 15,000 ng/L on Day 133 to 3,800 ng/L on Day 353. Interestingly, the



concentration continued to decline in this well after the biosparge system was shut-down, reaching 9.5 ng/L by Day 430. Propane concentrations in this well during the sampling events were also somewhat lower than in the other two wells used for sparging, reaching a maximum of only 37 µg/L on Day 353. This may merely reflect the time between system shutdown and well sampling since the propane consumption in the aquifer was rapid (see next Section), and the well appeared to operate properly as a sparge well, based on pressures and gas flow. Despite the differences in NDMA degradation rates, losses of > 99.9% were achieved in each well.

**Figure 5-24. Concentrations of NDMA in the demonstration plot.**



## 5.7.2 Volatile Organic Compounds (VOCs)

Volatile organic compounds (VOCs) were analyzed by EPA Method 8260 during both of the background sampling events on Day -84 and Day -70 in each of the monitoring wells. None of the 67 VOCs included in the EPA 8330 analyte list were detected at a concentration above the Practical Quantitation Limit (PQL) of 5 to 10 µg/L based on the compound. Because no VOCs were detected in the TPA, this analysis was not performed during the remainder of the demonstration.

## 5.7.3 Dissolved Gases

### 5.7.3.1 Propane

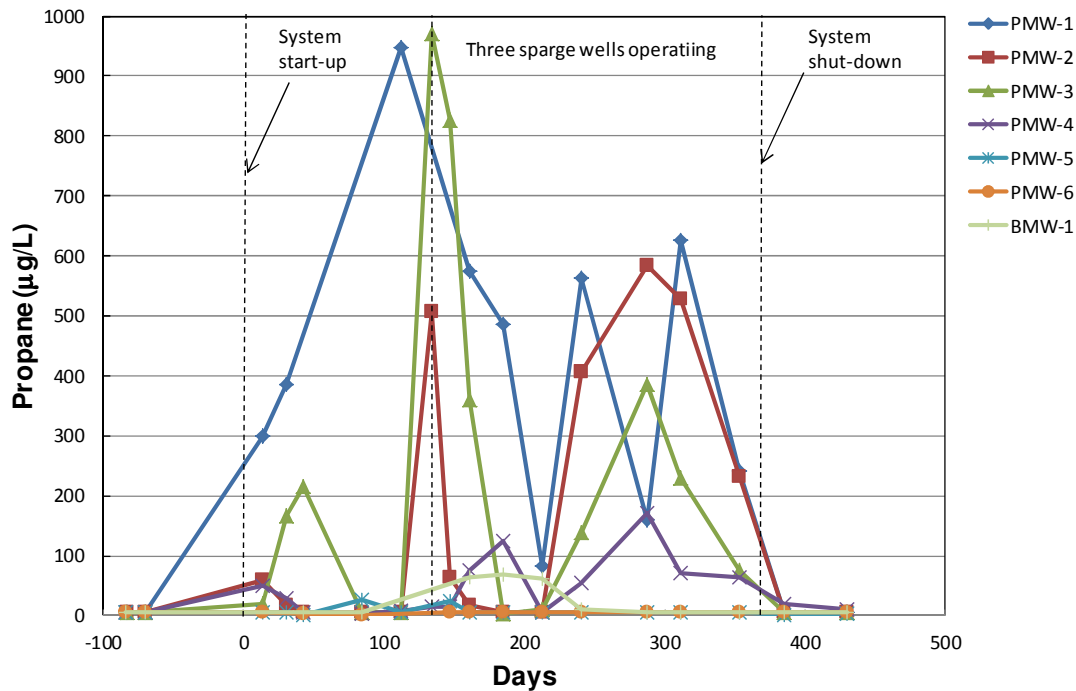
Propane was detected at between 20 and 300 µg/L in PMW-1, PMW-2, PMW-3 and PMW-4 14 days after the system start-up (**Figure 5-25** and **Appendix B**), indicating that the gas was being distributed throughout the demonstration plot. However, as noted previously, PMW-1 was primarily used for biosparging at the beginning of the demonstration due to issues with the original 5 sparge wells. New sparge wells BW-6 and BW-7 were installed ~ 4 months after start-up and run along with PMW-1 for the duration of the study. The addition of these wells significantly increased the propane concentrations in PMW-1, PMW-2, and PMW-3 (> 500 µg/L) and the overall amount of propane supplied to the demonstration plot. PMW-4 also had detectable propane albeit at lower concentrations than the other three wells. Thus, good gas distribution in the treatment area was documented. The maximum concentration of propane in groundwater throughout the demonstration plot did not exceed 1 mg/L at any time, even in PMW-1, which was used as a biosparge well in addition to a monitoring well. A desired ratio of at least 4 parts oxygen to 1 part propane (mg/L basis) was always exceeded (See **Section 6.2**).

It is interesting to note that low concentrations of propane (maximum of 70 µg/L) were detected in control well BMW-1 (which was ~ 75 ft away from the center of the demonstration plot), shortly after installation of BW-6 and BW-7. NDMA degradation was not indicated in this well, probably because the quantities of propane reaching this region were too low to stimulate bacterial activity. However, some of the sparged propane clearly traveled to this region of the aquifer. This may reflect the fact that the biosparging zone was in a confined region of the aquifer which acted to enhance horizontal transport of propane.

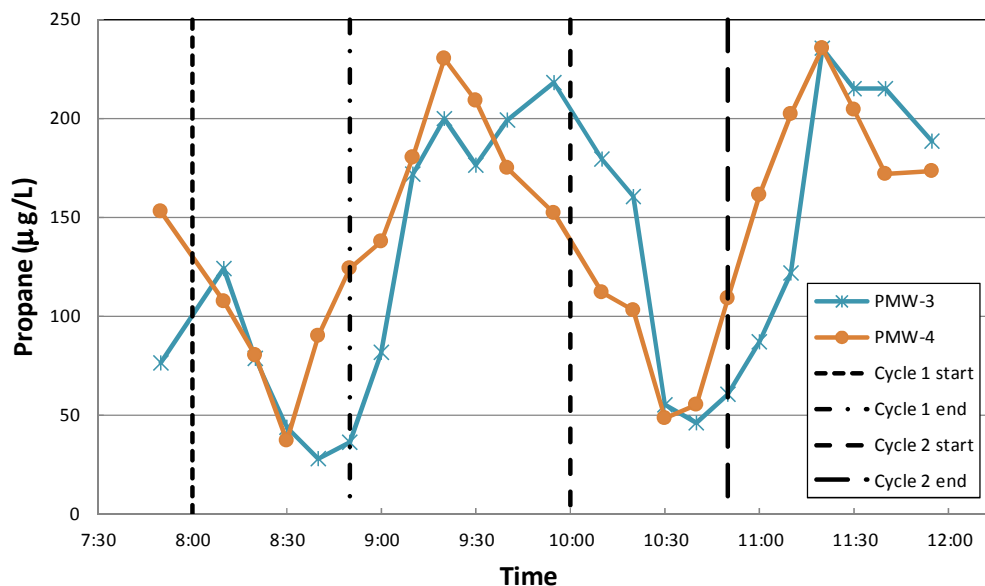
A field test was conducted on Day 230 to evaluate the flux of propane in the aquifer during sparge cycles using PMW-1, BW-6 and BW-7 (i.e., wells that operated from Day 133 to Day 373). During this test, two 45-min sparge-cycles were conducted at 6 SCFM with propane at 40% of the LEL. Each sparge cycle was followed by a recovery period. The concentration of propane was measured in PMW-3 and PMW-4 before, during, and after each of the sparge cycles at 23 sample times. The results from this test are provided in **Figure 5-26**. At the time of testing, propane concentrations in PMW-3 and PMW-4 ranged from a high of ~ 225 µg/L, which occurred 30 min after the end of each sparge cycle, to < 50 µg/L during the middle of each sparge interval. Presumably the delay in reaching a maximum concentration reflects time required for propane transport from the sparging wells to PMW-3 and PMW-4 as well as time required for propane dissolution. If one assumes that the decline in concentration is due predominantly to biodegradation, the propane first order decay rates in these wells are on the

order of  $0.02 - 0.03 \text{ min}^{-1}$ . These are in the range of rates observed for propane decay recently at Vandenberg Air Force Base during a demonstration of cometabolic degradation of 1,4-dioxane ( $0.01 - 0.05 \text{ min}^{-1}$ ) (Lippincott et al., 2015).

**Figure 5-25. Concentrations of propane in the demonstration plot.**



**Figure 5-26. Concentrations of propane in PMW-3 and PMW-4 during a propane biosparge test.** The start and end of the two sparge cycles are provided as dashed lines as indicated.



### 5.7.3.2 Dissolved oxygen

Dissolved oxygen (DO) in the TPA was generally below 5 mg/L prior to the initiation of biosparging. DO increased throughout the demonstration area PMWs consistently to > 10 mg/L during active sparging, even when only Well PMW-1 was in operation as the lone biosparge well (**Figure 5-27**). DO increases of similar magnitude were observed in downgradient well PMW-5 after installation of additional biosparge wells (BW-6, BW-7), and DO in downgradient well PMW-6 also increased to near 10 mg/L by the end of the demonstration. Slight increases in DO were detected in control well BMW-1, but the maximum DO was 5 mg/L and the concentration decreased after Day 300. This may be due to seasonal variations or indicate that, as with propane, a small amount of sparged air reached the side-gradient well. The objective of achieving DO values in excess of 10 mg/L throughout the TPA was achieved. There was clearly enough oxygen present in the TPA to support aerobic degradation of propane throughout the entire demonstration period.

### 5.7.3.3 Dissolved methane

Methane was detected in all of the monitoring wells during the two baseline sampling events at measurable concentrations, but typically at < 5 µg/L (**Appendix B**). Somewhat higher concentrations were detected in PMW-4 (212 µg/L on Day -84 and 145 µg/L on Day -70). This methane is most likely derived from methanogenic processes occurring in upgradient groundwater. Throughout the course of the demonstration, methane was detected sporadically at trace concentrations (typically < 1 µg/L) in wells PMW-1 through PMW-4, PMW-6, and BMW-1. Somewhat higher concentrations were detected in PMW-5, with concentrations of up to 100 µg/L observed during system operation and one measurement of 2,800 µg/L occurring on Day 385 after system shutdown. This well most likely intercepted a conductive layer with higher methane, due to current or past methanogenesis.

## 5.7.4 Oxidation-Reduction Potential (ORP)

The baseline ORP in the TPA ranged from ~ -100 mV to +100 mV prior to system start-up (**Figure 5-28**). With the exception of Day 161, when the ORP in three of the PMWs was negative, the ORP in the demonstration plot wells was generally greater than +100 mV, indicating that conditions were sufficiently oxidizing for an aerobic degradation process to occur. However, there was significant variation in ORP among the different sampling events, and most of the wells (including the background well BMW-1) tended to have similar ORP values at any given timepoint. For instance, on Day 241, Most of the wells had an ORP value of +100 mV, whereas on Days 287 and 311, most wells were near +400 mV, before declining again to ~ +150 mV by Day 353. The reason for this co-variation, particularly between the background well and performance monitoring wells is unclear, and is most likely due to inconsistencies often observed when collecting ORP readings in the field. The DO values in the wells were much more consistent over time.

## 5.7.5 Anions

Nitrate: The primary anions of interest in the TPA were nitrate and sulfate. Nitrate concentrations in PMW-1 through PMW-5 declined appreciably over the course of the demonstration (**Figure 5-29**). The background levels in most of the wells ranged from ~ 1.7 to

2.5 mg/L as NO<sub>3</sub>-N, with slightly lower values in PMW-6. During system operation, NO<sub>3</sub>-N in PMW-1 to PMW-5 declined to < 0.3 mg/L. A similar decline did not occur in background well BMW-1, and PMW-6 only showed a moderate decline toward the end of the demonstration. Nitrite was not detected in any of the wells. Because of the high DO and ORP, the loss of nitrate is likely not the result of denitrification, a process that is inhibited by oxygen. Rather, the consumption of nitrate is consistent with assimilation of N by propanotrophs in the aquifer as a required inorganic nutrient. No exogenous nutrients were added to the aquifer, so bacterial assimilation of existing nutrients is expected.

Sulfate: Sulfate concentrations throughout the TPA ranged from ~ 13 to 20 mg/L during baseline sampling (**Figure 5-30**). These concentrations remained consistently in this range over the course of the demonstration as would be expected under the oxidizing conditions in the aquifer.

Orthophosphate: Orthophosphate was not detected in the TPA groundwater at an MDL of 0.2 – 1 mg/L (**Appendix B**). Bacteria require phosphorus for growth, but it is likely that this was obtained from insoluble forms of phosphate in the aquifer that would not be detected by the EPA 300 analytical method.

Chloride: Chloride concentrations in groundwater remained in the vicinity of 10 mg/L throughout the demonstration (**Appendix B**).

### 5.7.6 pH

The pH in the demonstration plot generally remained between 6.5 and 7 during the demonstration (**Figure 5-31**). The pH was slightly elevated in PMW-1 (which was used as both a sparge well and a monitoring well) during some events, but did not exceed 7.5 SU.

### 5.7.7 Temperature

The mean groundwater temperature varied seasonally from ~ 14°C on Day -70 (December) to a maximum of ~ 19°C on Day 185 (August) (**Figure 5-32**).

Figure 5-27. Concentrations of dissolved oxygen in the demonstration plot wells.

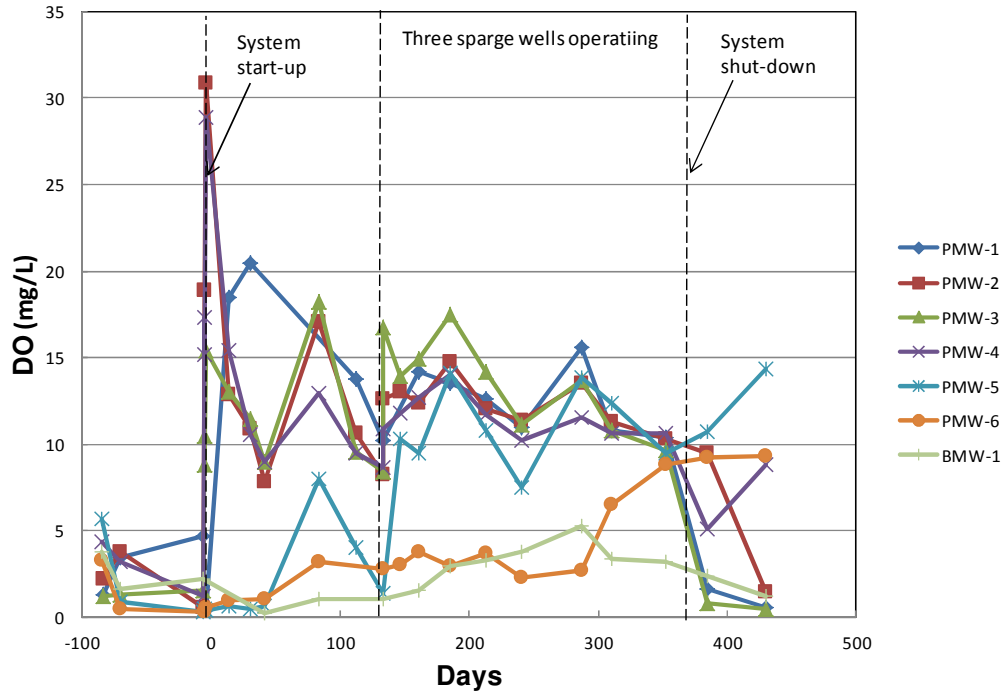
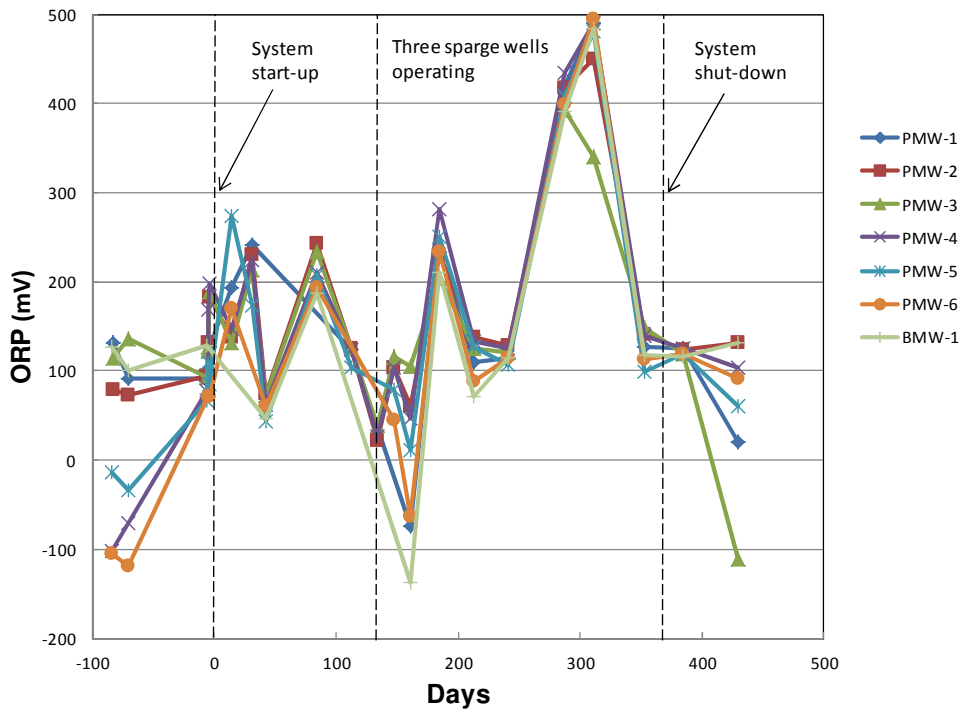
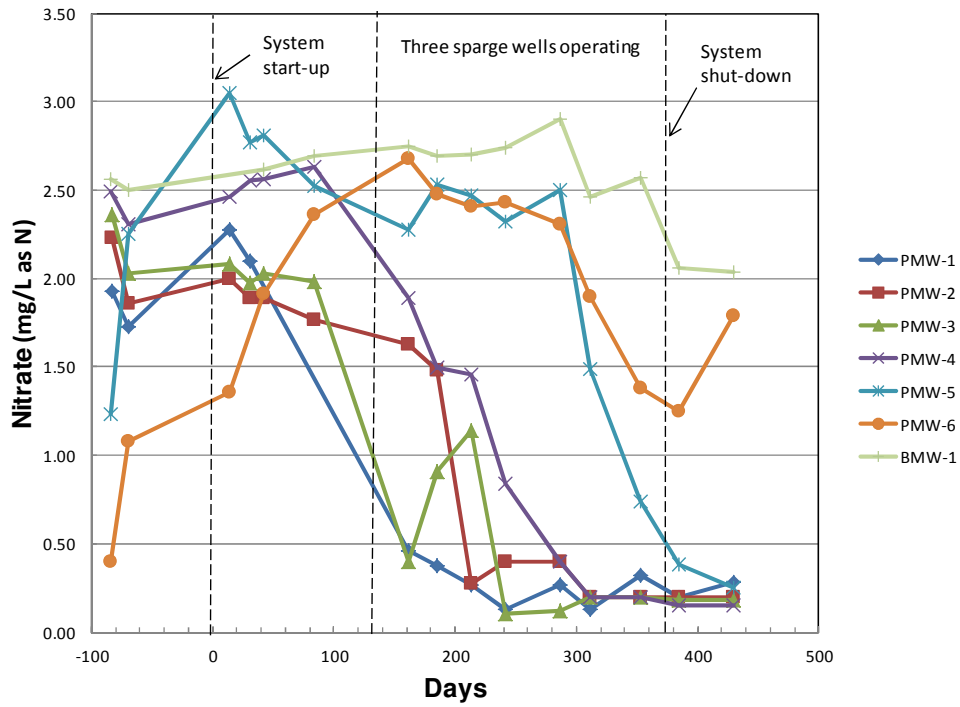


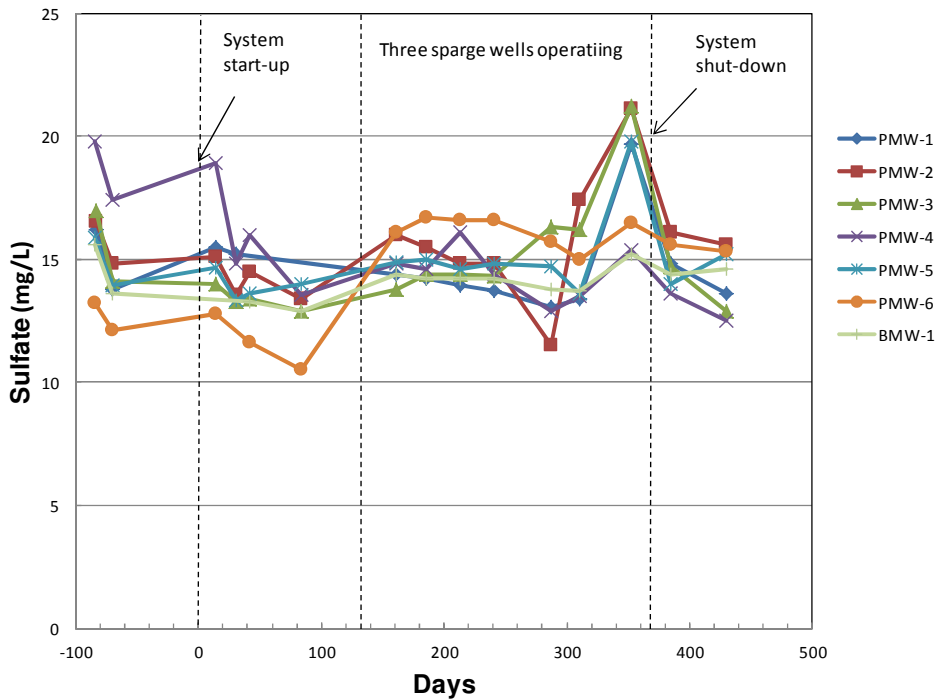
Figure 5-28. Oxidation-reduction potential (ORP) in the demonstration plot wells.



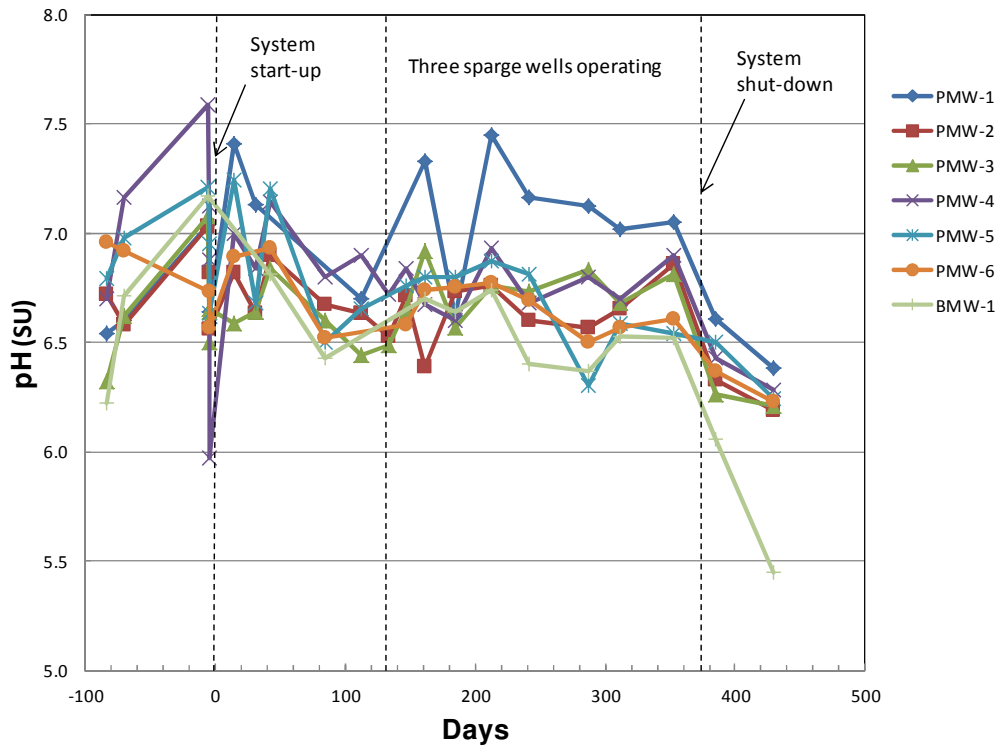
**Figure 5-29. Concentration of nitrate-N in the demonstration plot wells.**



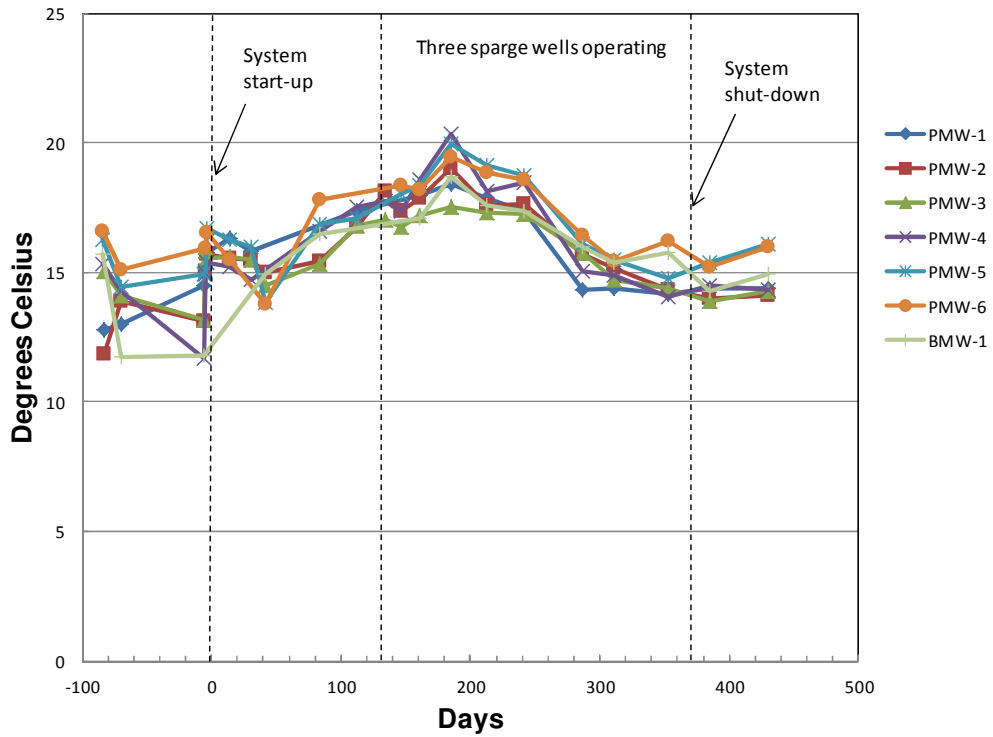
**Figure 5-30. Concentration of sulfate in the demonstration plot wells.**



**Figure 5-31. pH of groundwater in the demonstration plot wells.**



**Figure 5-32. Temperature of groundwater in the demonstration plot wells.**

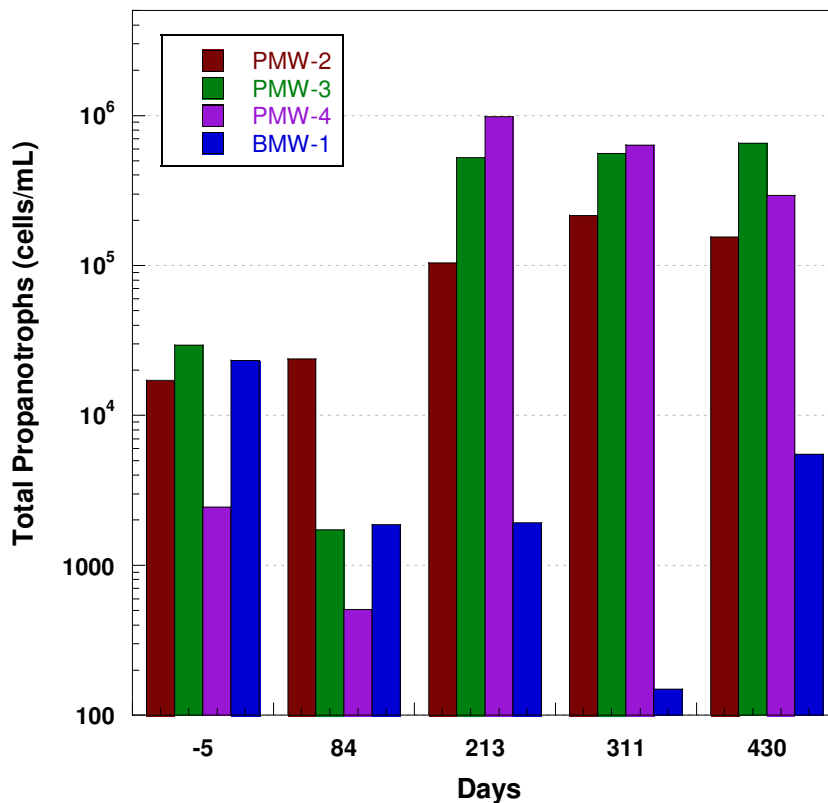




### 5.7.8 Total propanotrophs

The population of indigenous propanotrophs in wells PMW-2, PMW-3, and PMW-4 increased by greater than 1 log order over the course of the demonstration (Figure 5-33). On Day 311, the final day of sampling during active biosparging, the propanotroph density in these three wells ranged from  $2 \times 10^5$  to  $6 \times 10^5$  cells/mL. The propanotroph population in each of these wells remained reasonably constant thereafter even in the absence of propane addition for more than 100 days. By comparison, the cell density in BMW-1 declined from  $2 \times 10^4$  to  $6 \times 10^3$  cells/mL over the entire course of the demonstration. It should also be noted that only propanotrophs present as planktonic bacteria in groundwater were measured. It is possible, even likely, that the density of propanotrophs adsorbed to aquifer particles increased more significantly as some propanotrophs are known to form significant biofilms (Hatzinger et al., 2011; Webster et al., 2013; Lippincott et al., 2015).

Figure 5-33. Total propanotrophs in groundwater in the demonstration plot wells.



## 6.0 PERFORMANCE ASSESSMENT

Performance objectives were established for this demonstration to provide a basis for evaluating the results of the *in situ* remediation approach for NDMA in groundwater. Performance criteria were selected based on factors that would likely be considered when bringing the proposed technology to full-scale application. The performance objectives are provided in **Table 3-1**, and discussed in **Sections 3.1 to 3.4** in this document. The data for each given objective are provided in **Section 5.7** and **Appendix B**.

As summarized in **Sections 3.0** and **5.7**, the critical performance objectives for this demonstration were achieved. The following subsections summarize the data collected and provide a summary and assessment of the data supporting performance objectives.

### 6.1 EFFECTIVENESS OF NDMA TREATMENT

The key performance objectives for *in situ* NDMA treatment were was > 99% overall reduction in NDMA concentrations throughout the local treatment plot from the pre-treatment to the post-treatment phase, and reduction of NDMA to < 3 ng/L (the current California Public Health Goal for NDMA in water; OEHHA, 2006) in at least one of the performance monitoring wells. Both objectives were met. As presented in **Section 5.7.1**, NDMA declined by 99.7% to > 99.9% in the four PMWs within the zone of influence of the biosparge system, an area of ~ 20 ft by 20 ft (**Figure 3-1**). Baseline concentrations of  $25,000 \pm 6,000$  ng/L NDMA declined to between 2.7 and 72 ng/L by Day 353 (mean value  $40 \pm 30$  ng/L; 99.8% reduction). Similar declines in NDMA also were observed in biosparge wells BW-6 and BW-7, with reductions exceeding 99.9%. The sidegradient control well (BMW-1; ~ 75 ft from the core of the demonstration plot) that was not appreciably influenced by the system declined only 14%. The downgradient wells PMW-5 and PMW-6 showed measurable declines near the end of the demonstration, presumably as treated water from the biosparge plot began to reach this region of the aquifer. NDMA in PMW-5 and PMW-6 declined to 5,400 ng/L and 13,000 ng/L, respectively by Day 430, the final day of sample collection.

The rate of NDMA biodegradation in the TPA was calculated in wells PMW-2, PMW-3, and PMW-4. First-order rate constants were determined using data from Day 84 to Day 353 (See **Figure 5-24**). The degradation rates were  $0.019 \text{ day}^{-1}$  for PMW-3 ( $R^2 = 0.95$ ),  $0.031 \text{ day}^{-1}$  for PMW-4 ( $R^2 = 0.82$ ) and  $0.037 \text{ day}^{-1}$  for PMW-2 ( $R^2 = 0.68$ ). These rates equate to NDMA half-lives ranging from 19 to 36 days. These rates are similar to those reported by Lippincott et al. (2015), for treatment of 1,4-dioxane using propane biosparging at a site in California, where degradation rates varied from  $0.021 \text{ day}^{-1}$  to  $0.036 \text{ day}^{-1}$ .

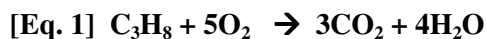
The data from this field test clearly indicate that propane biosparging is an effective approach to reduce the concentrations of NDMA in a groundwater aquifer by 3 to 4 orders of magnitude, and that concentrations in the low ng/L range can be achieved with continuous treatment. These results are consistent with data achieved in pure culture studies (Fournier et al., 2009) as well as

various bioreactor designs (Hatzinger et al., 2011; Webster et al., 2013). To our knowledge, this is the first report of successful *in situ* treatment of NDMA in groundwater using cometabolism or any other bioremediation approach. The application of propane biosparging for effective treatment of another DoD contaminant of concern, 1,4-dioxane, has also recently been reported (Lippincott et al., 2015).

## 6.2 ADEQUATE DISTRIBUTION OF GASES IN GROUNDWATER

Distribution of adequate propane and oxygen, and appropriate ratios of these two gases, was critical to the success of this remedial approach. Preliminary testing at the demonstration plot suggested that a gas sparging radius of at least 12.5 ft could be achieved in the TPA (**Sections 3.2 and 5.7.3**). When the system was started initially, with sparging primarily through well PMW-1 (and a low amount flow from BW-4 for ~ 2 weeks), dissolved propane was detected at between 5 and 50 µg/L in PMW-4, which was ~ 20 ft away from PMW-1 (**Figure 5-25 and Appendix B**) showing that the gas was being distributed in the aquifer. However, based on analytical results for both dissolved propane and NDMA, the amount of propane provided by PMW-1 alone was not sufficient for stimulating NDMA degradation throughout the TPA, so biosparge wells BW-6 and BW-7 were installed. The addition of these wells significantly increased the dissolved propane concentrations in PMW-1, PMW-2, and PMW-3 (> 500 µg/L) and the overall amount of propane supplied to the demonstration plot. PMW-4 also had detectable dissolved propane, albeit at lower concentrations than the other three wells. Thus, good gas distribution in the treatment area was documented.

The oxygen:propane ratio in the groundwater was also important to the success of this field demonstration. In particular it was important to ensure that adequate oxygen was present to support propane biodegradation and not create anoxic conditions in the aquifer. Propane was used as the primary carbon source/electron donor for bacterial growth in the aquifer with oxygen as the electron acceptor. The required molar ratio of propane (C<sub>3</sub>H<sub>8</sub>) to oxygen (O<sub>2</sub>) for complete oxidation of propane to carbon dioxide (CO<sub>2</sub>; not accounting for microbial biomass incorporation of C) is ~ 5 mols O<sub>2</sub> to 1 mol C<sub>3</sub>H<sub>8</sub> [**Eq. 1**]. When converted to mg/L, the above stoichiometry suggests that the oxygen requirement for bacteria to biodegrade 1 mg/L of C<sub>3</sub>H<sub>8</sub> is ~ 3.6 mg/L O<sub>2</sub>. Thus, on a mg/L basis, an oxygen to propane ratio of ~ 4:1 is required to ensure that anoxic conditions do not occur in the aquifer.



A desired ratio of oxygen to propane was always exceeded based on the analytical data generated during the project, with DO typically exceeding 10 mg/L (**Figure 5-27**) during system operation and dissolved propane never exceeding even 1 mg/L (**Figures 5-25 and 5-26**). During a sparging field test run under optimized conditions, two 45-min sparge-cycles were conducted at 6 SCFM with propane at 40% of the LEL, and propane was measured in PMW-3 and PMW-4 before, during, and after each of the sparge cycles (**Figure 5-26**). Propane concentrations in these wells, which reached ~ 225 µg/L, declined to 25 - 50 µg/L during ~ 1 hr, indicating rapid consumption of propane in the aquifer. If one assumes that the decline in concentration is due predominantly to biodegradation, the propane first order decay rates in these wells are 0.032 min<sup>-1</sup> (R<sup>2</sup> = 0.84)

for PMW-3 and  $0.021 \text{ min}^{-1}$  ( $R^2 = 0.94$ ) for PMW-4. These propane decay rates are consistent with those observed recently at Vandenberg Air Force Base during a demonstration of cometabolic degradation of 1,4-dioxane ( $0.01 - 0.05 \text{ min}^{-1}$ ) (Lippincott et al., 2015).

Between June 26, 2012 and September 16, 2012, normal system operation included a total biosparge injection rate of 6 SCFM (2 SCFM per biosparge well), for eight 34-minute cycles per day. Propane was added at a concentration of approximately 0.84 percent (40% of the LEL) for 24 minutes during each cycle. During this period, an estimated 0.73 lbs of propane was added daily. Between September 17, 2012 and February 20, 2013, normal system operation included a total biosparge injection rate of 6 SCFM (2 SCFM per biosparge well), for twelve 48-minute cycles per day. Propane was added at a concentration of approximately 0.84 percent (40% of the LEL) for 40 minutes during each cycle. During this period, an estimated 1.83 lbs of propane was added daily. A total of approximately 475 lbs (5 cylinders) of propane was injected throughout the demonstration

### 6.3 MINIMAL NEGATIVE IMPACTS TO GROUNDWATER GEOCHEMISTRY

One of the traditional issues with anaerobic bioremediation processes for many different contaminants is the general degradation in water quality in the vicinity of the treatment area. The addition of large quantities of organic substrates (e.g., to stimulate reduction of chlorinated solvents) often leads to the generation of organic byproducts (such as fatty acids), production of methane and hydrogen sulfide, and the mobilization of redox sensitive metals, such as iron, manganese, and arsenic among others (e.g., Leeson et al., 2004). The groundwater pH also can be affected in poorly buffered systems. When pumping wells are present downgradient of a treatment area (as is the case with OU 4 at Aerojet), the presence of organic byproducts and dissolved metals can lead to the chemical and biological fouling of both extraction wells and *ex situ* treatment systems. A previous injection of molasses at the Aerojet site caused such issues (*personal communication*, Scott Neville, Aerojet).

One of the advantages of aerobic treatment processes, such as that utilized during this demonstration, is minimal secondary impacts to groundwater geochemistry (provided that the groundwater environment is not naturally highly reducing). Based on the metrics examined (DO, ORP, pH) negative impacts on groundwater geochemistry in the plot area were not observed. DO increased throughout the demonstration area PMWs from  $\leq 1 \text{ mg/L}$  to  $> 10 \text{ mg/L}$  during active sparging. DO increases of similar magnitude were observed in downgradient well PMW-5 after installation of additional sparge wells (BW-6, BW-7), and DO in downgradient well PMW-6 also increased to near  $10 \text{ mg/L}$  by the end of the demonstration. Slight increases in DO were detected in control well BMW-1, but the maximum DO was  $5 \text{ mg/L}$  and the concentration decreased after Day 300. This may be a seasonal change. Similarly, the ORP in the demonstration plot wells was near or greater than  $+100 \text{ mV}$  for a majority of the demonstration. The pH in the demonstration plot generally remained between 6.5 and 7 during the demonstration. This pH was slightly elevated in PMW-1 (which was used as both a sparge well and a monitoring well) during some events, but did not exceed 7.5 SU.

## 6.4 INCREASE IN PROPANOTROPH POPULATION

Propane-oxidizing bacteria increased by more than 10-fold in treatment wells (PMW-2, PMW-3, PMW-4) relative to pre-treatment concentrations (between  $2 \times 10^3$  and  $3 \times 10^4$  cells/mL). On Day 311, the final day of sampling during active biosparging, the propanotroph density in these three wells ranged from  $2 \times 10^5$  to  $6 \times 10^5$  cells/mL. The propanotroph population in each of the wells remained reasonably constant thereafter even in the absence of propane addition for more than 80 days. By comparison, the cell density in BMW-1 declined from  $2 \times 10^4$  to  $6 \times 10^3$  cells/mL over the entire course of the demonstration. It is likely that even greater increases in indigenous propanotrophs occurred in the aquifer. The true extent of this increase is difficult to accurately measure without collecting and extracting cells from aquifer cores because only planktonic (free living) organisms are present in groundwater samples, and the number of cells present in biofilms are not typically or easily readily measured, even though they may be much higher than planktonic cells (Costerton et al., 1986). This may be a particularly true for some propanotrophic cells, which have been observed to be largely present in biofilms in flow-through systems (Hatzinger et al., 2011, Webster et al., 2013). For example, Hatzinger et al., (2011) reported that nearly all cells of the propanotroph *Rhodococcus ruber* ENV425 were adsorbed to surfaces in a membrane bioreactor study, and Lippincott et al., (2015) observed no significant increases in propanotroph density in groundwater during an *in situ* biosparging study despite rapid and increasing rates of propane consumption and 1,4-dioxane degradation. Thus, while the increase in propanotroph density in groundwater may be reflective of increases on solid surfaces, the overall cell numbers in the aquifer system may be much higher than reported based solely on the planktonic cells in groundwater.

## 6.5 SYSTEM RELIABILITY

As discussed in **Section 2.1**, we used an air- and propane-biosparging approach for this demonstration. Although biosparging is a form of air sparging, the focus is on providing the necessary gases (usually oxygen) for contaminant biodegradation and minimizing volatilization (USEPA, 1994). Therefore, the proposed biosparging system used during this demonstration was expected to operate reliably with minimal requirement for maintenance after start-up.

The system reliability was evaluated qualitatively through discussions with field personnel, and quantitatively by evaluating operational data (flows and LEL) collected from the Programmable Logic Controller (PLC) on the biosparging system, total time down for unplanned maintenance/repair (documented in field book), and total costs of the unplanned maintenance/repair (tracked via personnel hrs and replacement parts/materials).

Data collected by the PLC from June 26, 2012 (after additional sparging wells were installed) through February 20, 2013, showed that the system operated within design parameters (e.g., air flow and propane delivery) for 233 out of 240 days, or 97 percent of the time. Thus, system reliability exceeded the established performance objective of 90 percent detailed in **Section 3.5**. Additionally, no significant maintenance or repairs to the system were required during this period. Repairs to the system that were made during operation included the replacement of a needle valve, a solenoid valve, and the LEL meter (at the end of the demonstration). Considering the biosparging system used during the demonstration was >10 years old, these repairs were not unexpected. Maintenance to the system (beyond routine checks and flow

adjustments) primarily included replacement of spent propane cylinders, the installation of a heating blanket for the propane cylinder, and the installation of heat trace tape to propane delivery lines on the system.

## 7.0 COST ASSESSMENT

### 7.1 COST MODEL

Costs associated with various aspects of the demonstration were tracked throughout the course of the project in order to evaluate the cost of a potential full-scale bioremediation program and compare it against other remedial approaches. **Table 7-1** summarizes the various cost elements and total cost of the demonstration project. The costs have been grouped by categories as recommended in the Federal Remediation Technologies Roundtable Guide to Documenting Cost and Performance for Remediation Projects (FRTR, 1998). Many of the costs shown on this table are a product of the innovative and technology validation aspects of this project, and would not be applicable to a typical site application. Therefore, a separate “discounted costs” column that excludes or appropriately discounts these costs has been included in **Table 7-1** to provide a cost estimate for implementing this technology at the same scale as the demonstration (i.e., pilot scale).

Costs associated with the propane biosparging demonstration were tracked from September 2008 to November 2015. The total cost of the demonstration was \$897,000, which included \$313,000 in capital costs, \$181,000 in operation and maintenance (O&M) costs, and \$403,000 in demonstration-specific costs (cost related to ESTCP requirements, site selection and characterization).

**Table 7-1. Demonstration Cost Components.**

| Cost Element   | Details                               | Tracked Demonstration Costs | Discounted Costs <sup>1</sup> |
|--|---------------------------------------|-----------------------------|-------------------------------|
| <b>CAPITAL COSTS</b>   |                                       |                             |                               |
| Groundwater Modeling   | Labor                                 | \$1,000                     | \$0                           |
| System Design  | Labor                                 | \$13,000                    | \$13,000                      |
| Well Installation, Development & Surveying <sup>2</sup>  | Labor                                 | \$70,000                    | \$35,000                      |
|  | Materials                             | \$3,000                     | \$3,000                       |
|  | Subcontracts (driller/surveyor)       | \$59,000                    | \$30,000                      |
| System Installation (electrical service, biosparge trailers, system materials)                   | Labor                                 | \$45,000                    | \$15,000                      |
|  | Equipment & Materials                 | \$30,000                    | \$30,000                      |
|  | Subcontracts                          | \$75,000                    | \$15,000                      |
| Sparge Testing   | Labor and Materials                   | \$17,000                    | \$8,000                       |
| <b>Subtotal</b>  |                                       | <b>\$313,000</b>            | <b>\$149,000</b>              |
| <b>OPERATION AND MAINTENANCE COSTS</b>   |                                       |                             |                               |
| Groundwater Sampling   | Labor                                 | \$30,000                    | \$5,000                       |
|  | Materials                             | \$8,000                     | \$1,000                       |
| Analytical   | In-House Labor                        | \$20,000                    | \$5,000                       |
|  | Outside Labs                          | \$26,000                    | \$5,000                       |
| System O&M (including testing & start-up)  | Labor                                 | \$66,000                    | \$43,000                      |
|  | Materials (propane and consumables)   | \$5,000                     | \$5,000                       |
| Reporting & Data Management  | Labor                                 | \$24,000                    | \$6,000                       |
| Travel   |                                       | \$2,000                     | \$2,000                       |
| <b>Subtotal</b>  |                                       | <b>\$181,000</b>            | <b>\$72,000</b>               |
| <b>OTHER TECHNOLOGY-SPECIFIC COSTS</b>   |                                       |                             |                               |
| Site Selection   | Labor                                 | \$16,000                    | \$0                           |
| Site Characterization (drilling investigation, depth-dependent sampling, slug tests, pump tests) | Labor (including in-house analytical) | \$74,000                    | \$0                           |
|  | Materials                             | \$1,000                     | \$0                           |
|  | Subcontractor (driller)               | \$14,000                    | \$0                           |
| Treatability Studies and Column Testing  | Labor (including in-house analytical) | \$119,000                   | \$0                           |
|  | Outside Lab                           | \$26,000                    | \$0                           |
| IPR Meeting & Reporting  | Labor & Travel                        | \$21,000                    | \$0                           |
| Technology Transfer (presentations, papers)  | Labor & Travel                        | \$23,000                    | \$0                           |
| Demonstration Plan/Work Plan   | Labor                                 | \$41,000                    | \$10,000                      |
| Final Report   | Labor                                 | \$52,000                    | \$10,000                      |
| Cost and Performance Report  | Labor                                 | \$16,000                    | \$0                           |
| <b>Subtotal</b>  |                                       | <b>\$403,000</b>            | <b>\$20,000</b>               |
| <b>TOTAL COSTS</b>   |                                       | <b>\$897,000</b>            | <b>\$241,000</b>              |

Notes:

<sup>1</sup>Discounted costs are defined as estimated costs to implement this technology at the same scale as the demonstration. These costs do not include the technology validation aspects of this ESTCP demonstrations, such as site selection, treatability studies, extensive groundwater sampling, ESTCP demonstration reporting and meeting (IPR) requirements, and preparation of technical and cost and performance reports.



### 7.1.1 Capital Costs

Capital costs (primarily system design and installation) accounted for \$313,000 (or 35 percent) of the total demonstration costs. As indicated in **Table 7-1**, these costs exceed what would be expected during a typical remediation project due partially to the large number of performance monitoring wells (7) installed within the relatively small (50' x 30') demonstration area.

### 7.1.2 O&M Costs

O&M costs accounted for \$181,000 (or 20 percent) of the total demonstration cost. These costs consisted primarily of groundwater monitoring (including analytical), systems O&M, and reporting costs. System O&M costs were \$91,000, or 10 percent of total demonstration costs. The cost of the propane added during the demonstration was \$5,000, or 0.5 percent of total demonstration costs. The cost of consumable treatment components was minimal. Extensive performance monitoring activities were conducted to evaluate this technology including 13 groundwater sampling events (2 baseline and 11 performance).

### 7.1.3 Demonstration-Specific Costs

Other demonstration-specific costs include those not expected to be incurred during non-research-oriented remediation projects and accounted for \$403,000 (or 54 percent) of the total demonstration cost. These costs included site selection, laboratory treatability studies, column studies, ESTCP demonstration reporting, technology transfer, meeting requirements and preparation of detailed technical and cost and performance reports.

## 7.2 COST DRIVERS

### 7.2.1 General Considerations

The expected cost drivers for installation and operation of a propane biosparging delivery system for the remediation of NDMA-contaminated groundwater, and those that will determine the cost/selection of this technology over other options include the following:

- Depth of the plume below ground surface;
- Width, length, and thickness of the plume;
- Aquifer lithology and the presence or absence of impervious layers that would impede sparging;
- Regulatory/acceptance of alternatives to sparging that include groundwater extraction and re-injection;
- Length of time for clean-up (e.g., necessity for accelerated clean-up);
- The presence of indigenous propanotrophic bacteria capable of degrading NDMA;
- Concentrations of contaminants and alternate electron acceptors (e.g.,  $\text{NO}_3^-$ ,  $\text{SO}_4^{2-}$  and  $\text{O}_2$ );
- Presence of co-contaminants such as chloroform, chlorinated ethenes and chlorinated ethanes;

- The radius of influence that can be achieved via sparging; and
- O&M costs.

### 7.2.2 Competing Treatment Technologies

Two other technologies in addition to propane biosparging that have been proven to treat NDMA to below regulatory levels at the field scale include groundwater extraction (“pump and treat”) with either:

1. *Ex situ* ultraviolet (UV) treatment or
2. *Ex situ* fluidized bed reactor (FBR) treatment using cometabolic propanotrophs.

To our knowledge, no other *in situ* technologies have been demonstrated to consistently reduce concentrations of NDMA in groundwater aquifers to below regulatory levels of concern.

Pump and treat technologies provide capture of contaminated groundwater, and above-ground treatment of the extracted water prior to discharge or re-injection into the subsurface. While these systems can provide protection to downgradient receptors if designed properly, they are inefficient at removing contaminant mass from a plume and/or source zone, and often require operation for decades, leading to high overall costs.

## 7.3 COST ANALYSIS

A previous evaluation of cost for NDMA treatment technologies is provided in the Final Report for ESTCP Project 200829 entitled “Treatment of N-Nitrosodimethylamine (NDMA) in Groundwater using a Fluidized Bed Bioreactor” (Hatzinger and Webster, 2014). The cost analysis included in that report includes both the UV and FBR treatment approaches, and the following cost analysis is based in part on the cost estimates developed for that project. A cost analysis for the base case was performed for the following technologies:

1. Propane biosparging barrier
2. Pump and treat with UV treatment
3. Pump and treat with FBR treatment

### 7.3.1 Base Case

A hypothetical base case was developed as a template for the cost analysis as presented in Krug et al., (2009). The base case presents a situation where a shallow aquifer consisting of homogeneous silty sands is contaminated with NDMA. The NDMA-contaminated groundwater extends from 10 to 40 feet bgs along the direction of groundwater flow for 800 feet, and is 400 feet in width (**Figure 7-1**). The specific base case site characteristics including aquifer characteristics and design parameters for each of the remedial approaches analyzed are summarized in **Table 7-2**.

As indicated in **Table 7-2**, the base case assumes a groundwater seepage velocity of approximately 33 ft/year, and that two pore volumes of clean water will need to flush through the impacted area to achieve the cleanup objectives. However, there are a number of factors, such as the degree of heterogeneity of the geological media that will determine the actual number of pore volumes of clean water required to flush through the subsurface to achieve target treatment objectives. Variations in the hydraulic conductivity (K) of the aquifer materials can allow a significant fraction of the total mass of contaminants to diffuse into low K layers, and then act as an ongoing source to the higher K zones. In most geological settings, it is likely that more than two pore volumes would be required to achieve treatment objectives, thus leading to longer treatment times (and costs) for passive and P&T approaches.

The following subsections provide cost estimates for implementation of each of the three treatment approaches for the base case. The cost estimates provide insight into the comparative capital, O&M, and long term monitoring costs to better identify cost drivers for each technology/approach. Total costs and the Net Present Value (NPV) of future costs were calculated for each of the treatment approaches. Future costs (O&M and long term monitoring costs) are discounted, using a 1.4% real discount rate to determine the NPV estimates of these costs (OMB Circular A-94, 2015). Specifically excluded from consideration are the costs of pre-remedial investigations and treatability studies, assuming the costs for these activities would be similar for each alternative. The cost analyses comparing the above approaches are presented below based on a 30-year operating scenario.

**Table 7-2. Summary of Base Case Site Characteristics and Design Parameters.**

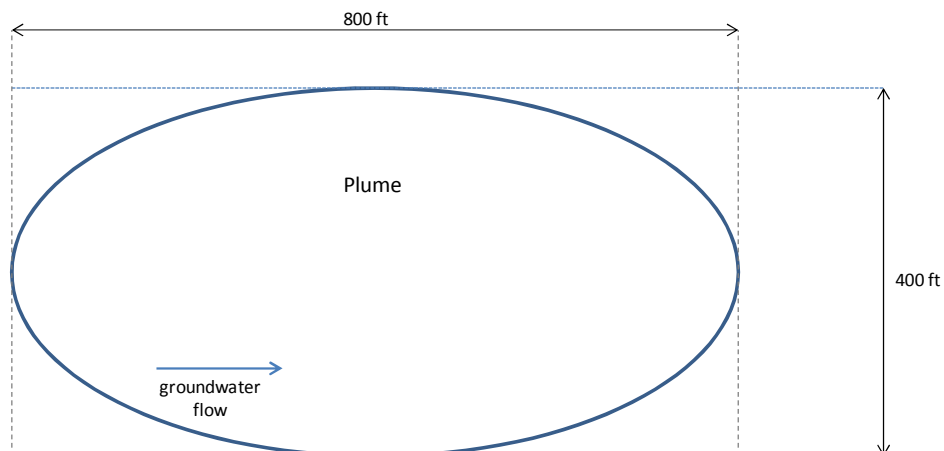
| Design Parameter                              | Units         | Alternative               |                                  |                                   |
|---|---------------|---------------------------|----------------------------------|-----------------------------------|
|   |               | Propane Biosparge Barrier | Pump and Treat with UV Treatment | Pump and Treat with FBR Treatment |
| Width of Plume                                | feet          | 400                       | 400                              | 400                               |
| Length of Plume                               | feet          | 800                       | 800                              | 800                               |
| Depth to Water                                | feet          | 10                        | 10                               | 10                                |
| Vertical Saturated Thickness                  | feet          | 40                        | 40                               | 40                                |
| Porosity                                      | dimensionless | 0.25                      | 0.25                             | 0.25                              |
| Gradient                                      | dimensionless | 0.008                     | 0.008                            | 0.008                             |
| Hydraulic Conductivity                        | ft/day        | 2.8                       | 2.8                              | 2.8                               |
| Groundwater Seepage Velocity                  | ft/year       | 33                        | 33                               | 33                                |
| Nitrate Concentration                         | mg/L          | 15                        | 15                               | 15                                |
| Dissolved Oxygen Concentration                | mg/L          | 5                         | 5                                | 5                                 |
| Assumed Number of Pore Volumes to Flush Plume | each          | 2                         | 2                                | 2                                 |
| Number of Barriers                            | each          | NA                        | 1                                | 1                                 |
| Number of Monitoring Wells                    | each          | 10                        | 10                               | 10                                |
| Number of Sparge Wells                        | each          | 32                        | 0                                | 0                                 |
| Number of Extraction Wells                    | each          | 0                         | 9                                | 9                                 |

|                                    |       |    |    |    |
|------------------------------------|-------|----|----|----|
| Groundwater Travel Time to Barrier | years | 24 | 24 | 24 |
| Years to Clean Up Groundwater      | years | 48 | 48 | 48 |

NA - Not Applicable

**Figure 7-1. Base case plume characteristics.**



### 7.3.2 Propane Biosparge Barrier

The propane biosparge barrier alternative assumes that a series of sparge wells will be installed at the downgradient edge and perpendicular to the axis of the plume shown in **Figure 7-1**. Spacing for the sparge wells is assumed to be 25 feet with both a shallow and deep sparge well installed at each of 16 locations for a total of 32 sparge wells. A propane injection system will be constructed including a compressor, controls and associated piping. An enclosure will be installed to contain the above ground components. The biosparge barrier will be operated for a period of 30 years, and this alternative assumes 30 years of associated O&M and long term monitoring costs.

As summarized in **Table 7-3**, the estimated total costs for this alternative over 30 years are \$2,880,000 with a total NPV of lifetime costs of \$2,332,000. The capital cost is approximately \$481,000 including design, work plan, installation of sparge wells and construction of the propane injection system along with startup and testing. The NPV of the O&M is estimated at approximately \$1,450,000 for the 30 years of treatment. The O&M costs include the labor costs associated with operations, costs for equipment repair and replacement, and cost for propane. The NPV of the 30 years of monitoring and reporting costs is estimated to be \$401,000.

This alternative ranks lowest in estimated total remedy cost and lowest in NPV of lifetime costs compared to the other alternatives (see **Table 7-3**) due to the relatively low equipment and ongoing maintenance requirements compared to the other alternatives evaluated.

**Table 7-3. Cost Components for Biosparging.**

|  | Year Cost is Incurred |                |                |                |                |               |                   | NPV of Costs*    | Total Costs      |
|--|-----------------------|----------------|----------------|----------------|----------------|---------------|-------------------|------------------|------------------|
|  | 1                     | 2              | 3              | 4              | 5              | 6             | 7 to 30           |                  |                  |
| <b>CAPITAL COSTS</b>   |                       |                |                |                |                |               |                   |                  |                  |
| System Design  | 36,580                | -              | -              | -              | -              | -             | -                 | 36,580           | 36,580           |
| Well Installation  | 216,258               | -              | -              | -              | -              | -             | -                 | 216,258          | 216,258          |
| System Installation  | 210,186               | -              | -              | -              | -              | -             | -                 | 210,186          | 210,186          |
| Start-up and Testing   | 17,978                | -              | -              | -              | -              | -             | -                 | 17,978           | 17,978           |
| <b>SUBCOST (\$)</b>  | <b>481,002</b>        | -              | -              | -              | -              | -             | -                 | <b>481,002</b>   | <b>481,002</b>   |
| <b>OPERATION AND MAINTENANCE COSTS</b>                                   |                       |                |                |                |                |               |                   |                  |                  |
| System Operation and Maintenance   | 62,557                | 63,557         | 63,557         | 63,557         | 63,557         | 63,557        | 63,557 every year | 1,450,931        | 1,905,724        |
| <b>SUBCOST (\$)</b>  | <b>62,557</b>         | <b>63,557</b>  | <b>63,557</b>  | <b>63,557</b>  | <b>63,557</b>  | <b>63,557</b> |                   | <b>1,450,931</b> | <b>1,905,724</b> |
| <b>LONG TERM MONITORING COSTS</b>  |                       |                |                |                |                |               |                   |                  |                  |
| Sampling/Analysis/Reporting<br>(Quarterly through 5 years then Annually) | 37,002                | 37,002         | 37,002         | 37,002         | 37,002         | 12,369        | 12,369 every year | 400,991          | 494,235          |
| <b>SUBCOST (\$)</b>  | <b>37,002</b>         | <b>37,002</b>  | <b>37,002</b>  | <b>37,002</b>  | <b>37,002</b>  | <b>12,369</b> |                   | <b>400,991</b>   | <b>494,235</b>   |
| <b>TOTAL COST (\$)</b>   | <b>580,562</b>        | <b>100,559</b> | <b>100,559</b> | <b>100,559</b> | <b>100,559</b> | <b>75,926</b> |                   | <b>2,332,924</b> | <b>2,880,961</b> |

Notes:

NPV - Net Present Value

\* - NPV calculated based on a 2% discount rate

### 7.3.3 Pump and Treat with UV Treatment

The Pump and Treat with UV Treatment alternative includes the design and construction of a groundwater extraction system and groundwater treatment plant. Groundwater is pumped from nine extraction wells to the treatment facility. This water is initially pumped into double-walled high-density polyethylene (HDPE) pipe that routes water to a surge tank in the treatment building. Before entering the surge tank, the groundwater is injected with a polyphosphate scale control chemical, which is distributed on a flow-proportional basis. Water is pumped into particulate filters before entering the UV reactor where it is exposed to low pressure amalgam ultraviolet light lamps. The UV light provided by the lamps destroys the NDMA via direct photolysis leading to dimethylamine, nitrate and nitrite (Stefan and Bolton, 2002). Treated groundwater exiting the UV reactor is then either recycled into a surge tank or proceeds to an infiltration basin.

As summarized in **Table 7-4**, the estimated total costs for this alternative over 30 years are \$5,603,000 with a total NPV of lifetime costs of \$4,637,000. The capital cost including design, work plan, installation of extraction wells and treatment plant construction, are approximately \$1,461,000. The NPV of the O&M is estimated at approximately \$2,775,000 for the 30 years of treatment. The O&M costs primarily include the labor and material costs associated with equipment replacement and electrical requirements. Replacement of UV lamp components is assumed to occur every two years at a cost of \$27,000 per replacement event. Electrical consumption is the highest for this alternative due to the electrical requirement for the UV equipment. The NPV of the 30 years of monitoring and reporting costs is estimated to be \$401,000. This alternative ranks highest in both total remedy cost and NPV of lifetime costs compared to the other alternatives evaluated (See **Table 7-6**).

**Table 7-4. Cost Components for Pump and Treat with UV Treatment.**

|  | Year Cost is Incurred |                |                |                |                |                |                    | NPV of Costs*    | Total Costs      |
|--|-----------------------|----------------|----------------|----------------|----------------|----------------|--------------------|------------------|------------------|
|  | 1                     | 2              | 3              | 4              | 5              | 6              | 7 to 30            |                  |                  |
| <b>CAPITAL COSTS</b>   |                       |                |                |                |                |                |                    |                  |                  |
| System Design  | 95,142                | -              | -              | -              | -              | -              | -                  | 95,142           | 95,142           |
| Well Installation  | 108,738               | -              | -              | -              | -              | -              | -                  | 108,738          | 108,738          |
| System Installation  | 1,230,835             | -              | -              | -              | -              | -              | -                  | 1,230,835        | 1,230,835        |
| Start-up and Testing   | 26,250                | -              | -              | -              | -              | -              | -                  | 26,250           | 26,250           |
| <b>SUBCOST (\$)</b>  | <b>1,460,965</b>      |                |                |                |                |                |                    | <b>1,460,965</b> | <b>1,460,965</b> |
| <b>OPERATION AND MAINTENANCE COSTS</b>                                   |                       |                |                |                |                |                |                    |                  |                  |
| System Operation and Maintenance   | 108,195               | 135,031        | 108,195        | 135,031        | 108,195        | 135,031        | 108,195 to 135,031 | 2,775,150        | 3,648,404        |
| <b>SUBCOST (\$)</b>  | <b>108,195</b>        | <b>135,031</b> | <b>108,195</b> | <b>135,031</b> | <b>108,195</b> | <b>135,031</b> |                    | <b>2,775,150</b> | <b>3,648,404</b> |
| <b>LONG TERM MONITORING COSTS</b>  |                       |                |                |                |                |                |                    |                  |                  |
| Sampling/Analysis/Reporting<br>(Quarterly through 5 years then Annually) | 37,002                | 37,002         | 37,002         | 37,002         | 37,002         | 12,369         | 12,369 every year  | 400,991          | 494,235          |
| <b>SUBCOST (\$)</b>  | <b>37,002</b>         | <b>37,002</b>  | <b>37,002</b>  | <b>37,002</b>  | <b>37,002</b>  | <b>12,369</b>  |                    | <b>400,991</b>   | <b>494,235</b>   |
| <b>TOTAL COST (\$)</b>   | <b>1,606,162</b>      | <b>172,033</b> | <b>145,197</b> | <b>172,033</b> | <b>145,197</b> | <b>147,400</b> |                    | <b>4,637,105</b> | <b>5,603,603</b> |

Notes:

NPV - Net Present Value

\* - NPV calculated based on a 2% discount rate

### 7.3.4 Pump and Treat with FBR Treatment

The Pump and Treat with FBR Treatment alternative also includes the design and construction of a groundwater extraction system and groundwater treatment plant. The treatment system contains a full-scale FBR constructed with welded stainless steel with a closed top design. Included with the FBR is a fluidization pump, an influent distribution system, and effluent/biomass collection system, two biomass separators, 7100 pounds of carbon media (coconut shell based), and oxygen generator, and a gas delivery system for both oxygen and propane. Provided for the entire plant is a systems controls package that includes a control panel with motor controls, a programmable logic control (PLC) system with operator interface and necessary electrical power supply.

As summarized in **Table 7-5**, the estimated total costs for this alternative over 30 years are \$5,139,000 with a total NPV of lifetime costs of \$4,319,000. The capital cost including design, work plan, treatment system construction, and installation of extraction and monitoring wells are approximately \$1,601,000. The NPV of the O&M is estimated at approximately \$2,317,000 for the 30 years of treatment. The O&M costs primarily include the labor and material costs associated with routine operations. The NPV of the 30 years of monitoring and reporting costs is estimated to be \$401,000. This alternative ranks second in both estimated total remedy cost and NPV of lifetime costs (see **Table 7-6**).

**Table 7-5. Cost Components for Pump and Treat with FBR Treatment.**

|  | Year Cost is Incurred |                |                |                |                |                |                    | NPV of Costs*    | Total Costs      |
|--|-----------------------|----------------|----------------|----------------|----------------|----------------|--------------------|------------------|------------------|
|  | 1                     | 2              | 3              | 4              | 5              | 6              | 7 to 30            |                  |                  |
| <b>CAPITAL COSTS</b>   |                       |                |                |                |                |                |                    |                  |                  |
| System Design  | 95,142                | -              | -              | -              | -              | -              | -                  | 95,142           | 95,142           |
| Well Installation  | 108,738               | -              | -              | -              | -              | -              | -                  | 108,738          | 108,738          |
| System Installation  | 1,370,835             | -              | -              | -              | -              | -              | -                  | 1,370,835        | 1,370,835        |
| Start-up and Testing   | 26,250                | -              | -              | -              | -              | -              | -                  | 26,250           | 26,250           |
| <b>SUBCOST (\$)</b>  | <b>1,600,965</b>      | <b>-</b>       | <b>-</b>       | <b>-</b>       | <b>-</b>       | <b>-</b>       | <b>-</b>           | <b>1,600,965</b> | <b>1,600,965</b> |
| <b>OPERATION AND MAINTENANCE COSTS</b>                                   |                       |                |                |                |                |                |                    |                  |                  |
| System Operation and Maintenance   | 96,153                | 101,653        | 101,653        | 101,653        | 101,653        | 101,653        | 101,653 every year | 2,316,711        | 3,044,104        |
| <b>SUBCOST (\$)</b>  | <b>96,153</b>         | <b>101,653</b> | <b>101,653</b> | <b>101,653</b> | <b>101,653</b> | <b>101,653</b> | <b>-</b>           | <b>2,316,711</b> | <b>3,044,104</b> |
| <b>LONG TERM MONITORING COSTS</b>  |                       |                |                |                |                |                |                    |                  |                  |
| Sampling/Analysis/Reporting<br>(Quarterly through 5 years then Annually) | 37,002                | 37,002         | 37,002         | 37,002         | 37,002         | 12,369         | 12,369 every year  | 400,991          | 494,235          |
| <b>SUBCOST (\$)</b>  | <b>37,002</b>         | <b>37,002</b>  | <b>37,002</b>  | <b>37,002</b>  | <b>37,002</b>  | <b>12,369</b>  | <b>-</b>           | <b>400,991</b>   | <b>494,235</b>   |
| <b>TOTAL COST (\$)</b>   | <b>1,734,120</b>      | <b>138,655</b> | <b>138,655</b> | <b>138,655</b> | <b>138,655</b> | <b>114,022</b> | <b>-</b>           | <b>4,318,666</b> | <b>5,139,303</b> |

*Notes:*

NPV - Net Present Value

\* - NPV calculated based on a 2% discount rate

**Table 7-6. Summary of Capital Costs and NPV of Costs for O&M and Monitoring.**

| <b>Alternative</b>                | <b>Capital Costs</b> | <b>NPV of 30 Years of O&amp;M Costs</b> | <b>NPV of 30 Years of Monitoring Costs</b> | <b>NPV of 30 Years of Total Remedy Costs</b> | <b>Total 30-Year Remedy Costs</b> |
|-----------------------------------|----------------------|---|--|--|-----------------------------------|
| Biosparge Barrier                 | \$290                | \$600                                   | \$400                                      | \$1,290                                      | \$1,570                           |
| Pump and Treat with UV Treatment  | \$1,410              | \$1,780                                 | \$400                                      | \$3,590                                      | \$4,240                           |
| Pump and Treat with FBR Treatment | \$1,570              | \$1,320                                 | \$400                                      | \$3,290                                      | \$3,800                           |

*notes:* All costs are in thousands of dollars

NPV - Net Present Value; current value of future costs based on a 2% annual discount rate

O&M - Operation and Maintenance



## **8.0 IMPLEMENTATION ISSUES**

### **8.1 END-USER ISSUES**

The primary end-users of this technology are expected to be DoD site managers and their contractors, consultants and engineers. The general concerns of these end users are likely to include the following: (1) technology applicability and performance under local site conditions; (2) safety; (3) secondary groundwater impacts and (4) technology cost compared to other remedial options. These implementation issues are addressed in the following sections.

#### **8.1.1 Technology Applicability and Performance under Local Site Conditions**

The primary objective of co-metabolic treatment for NDMA is to supply propane and oxygen to an aquifer for microbial growth. There are number of different approaches to achieve this end whose applicability depends on site geology/hydrogeology and plume characteristics. These approaches include including (1) air- and propane-biosparging as applied in this demonstration, (2) groundwater recirculation with above-ground propane and oxygen addition, (3) bubble-free gas injection systems, and (4) trenches with air and propane injection lines, among others (Steffan et al., 2003). The critical objective with any of these approaches is to evenly and consistently distribute propane and oxygen gas throughout the desired treatment area.

We recently tested a groundwater recirculation design for treatment of 1,2-dibromoethane (EDB) in groundwater using ethane gas and pure oxygen (Hatzinger et al., 2015, Hatzinger and Begley, 2014). In this case, groundwater was pumped from an existing extraction well at 10-12 GPM, amended with oxygen, ethane gas, and inorganic nutrients, and then re-injected into an injection well (approximately 60 ft upgradient), forming a closed loop. Good gas distribution was observed in system monitoring wells and the biodegradation of ethane and EDB were documented throughout the demonstration plot. EDB reached concentrations below the stringent Massachusetts MCL of 0.02 µg/L. The one potential O&M issue with this approach was the observation of biofouling in the injection well tubing when ethane concentrations were increased from 2 mg/L in the injected water to 4 mg/L during one phase of the study. A recent study also examined the use of bubble-free gas injection systems to supply oxygen and propane to a groundwater aquifer (Shaw Environmental, 2013). This approach was significantly less successful than either biosparging or groundwater recirculation for two main reasons (1) the inability to adequately control the oxygen:propane ratio with the system used, and (2) the inability to supply and distribute enough oxygen in the aquifer to overcome the highly reducing geochemical conditions. Gas distribution can be a significant limitation with this type of system.

The biosparging technology utilized during this demonstration consisted of the injection of propane gas into a groundwater aquifer in a stream of air. This approach is both highly flexible and widely applicable under differing aquifer conditions. In this case, biosparging was conducted in a confined interval in the layered aquifer. One of the significant advantages of this approach is that groundwater does not have to be pumped from the subsurface, thus avoiding all of the common capital costs and O&M issues with groundwater extraction and reinjection. This

approach can also be used cost-effectively in deep as well as shallow aquifers and to aerially wide plumes. Aquifer depth is one of the limiting factors for fully passive designs, which become increasingly expensive due to close spacing of injection points and/or technically impractical (e.g., for passive trench barriers) as the depth to the water table increases (Stroo and Ward, 2009). A semi-passive pumping design has fewer limitations with depth. Similarly, wide plumes are more readily treated with active or semi-passive approaches than with fully passive designs as a few wells (and high flow rates) can often be used to distribute cosubstrate over a large area rather than closely spaced wells or injection points [see Stroo and Ward (2009) for further comparisons of different amendment designs].

### **8.1.2 Safety**

Because propane is a flammable gas, specific safety measures must be considered when designing, installing, and monitoring an *in situ* propane biosparge system. However, it is very easy for a competent engineer to design a system that is safe for operation. All electrical equipment and wiring in the system trailer supplying propane should be intrinsically safe, and the propane cylinders/tanks should be stored outside of the trailer. During this demonstration, we used a two trailer system, one that housed the system controls and compressor (non-explosion proof) and one that mixed the compressed air with propane gas (explosion proof). When operating properly, no propane gas should be released into the trailer housing the propane mixing equipment, and safeguards should be put in place to automatically shut the system down and vent the atmosphere in case of a catastrophic failure (e.g., rupture of a propane feed line). This can be achieved using an LEL meter that shuts down propane feed and activates a vented roof fan if a specific percentage of the LEL for propane is exceeded in room air. Communication systems should also be used to alert an operator if this safety system is activated.

A second consideration is groundwater monitoring. If high concentrations of propane (i.e., > LEL) are added to groundwater, there is the potential for levels above the LEL to exist in a sealed biosparge well or groundwater monitoring well. To prevent this possibility, propane should be added to groundwater at concentrations significantly below the LEL. During this demonstration, we did not exceed a propane concentration of 40% of the LEL. Wells can also be designed with vents in the well caps so that sampling personnel can safely take an initial measure of the propane concentration in each well before sampling the groundwater (using a PID meter) and then vent the well with fresh air if necessary prior to sampling. In addition, the system should be shut down during sampling events, and signs specifying that a flammable gas is being used in the area and that smoking is not permitted should be clearly visible to all personnel. With these simple design and operational precautions, this type of system can be safely operated and sampled.

### **8.1.3 Secondary Impacts to the Local Aquifer**

One of the significant advantages of an aerobic treatment system of this type is that there are typically very few negative impacts to groundwater geochemistry (provided that the groundwater environment is not naturally highly reducing), particularly in comparison to *in situ* anaerobic systems where large amounts of carbon substrate are applied to treat contaminants. As noted in

**Section 6.3**, DO throughout the demonstration area typically increased from  $\leq 1$  mg/L to  $> 10$  mg/L over the course of this demonstration. Similarly, the ORP in the demonstration plot groundwater was near or greater than +100 mv, and the pH generally remained between 6.5 and 7. Thus, the water became highly aerobic and oxidizing and remained neutral in pH. It should also be noted that propane never exceeded 1 mg/L in the site groundwater, and the half-life of the dissolved propane was on the order of minutes rather than days or weeks (see **Section 6.2**), so the presence of residual propane in the aquifer is highly unlikely with a properly operating system.

#### **8.1.4 Technology Cost Compared to Other Remedial Options**

The expected cost drivers for the installation and operation of an *in situ* bioremediation system for NDMA and comparisons to other remedial approaches are provided in **Section 7**.

## 9.0 REFERENCES

- Alexander, M. 1994. Cometabolism. pp. 177-193. *In* Biodegradation and Bioremediation, Academic Press, NY.
- Alexander, M. 1967. *In* Agriculture and the Quality of Our Environment, N. C. Brady (Ed.). American Association for the Advancement of Science, Washington, D.C. pp. 331-342.
- Alvarez-Cohen, L. 2012. Oxygenase-Catalyzed Biodegradation of Emerging Water Contaminants: 1,4-Dioxane and N-nitrosodimethylamine (NDMA). Strategic Environmental Research and Development Program Final Report, SERDP Project ER-1417, 90 pp. Online: <http://www.serdp.org/Program-Areas/Environmental-Restoration/Contaminated-Groundwater/Emerging-Issues/ER-1417/ER-1417>.
- Annable, M.D., K. Hatfield, J. Cho, H. Klammler, B.L. Parker, J.A. Cherry, and P.S.C. Rao. 2005. Field-scale evaluation of the passive flux meter for simultaneous measurement of groundwater and contaminant fluxes. *Environ. Sci. Technol.* 39:7914-7201.
- Battelle. 2001. ESTCP Final Report: Use of Co-metabolic Air Sparging to Remediate Chloroethene-Contaminated Groundwater Aquifers. Columbus, OH. July 2001, 194 pp.
- Bruce, C.L., I.L. Amerson, R.L. Johnson, and P.C. Johnson. 2001. Use of SF<sub>6</sub>-based diagnostic tool for assessing air distributions and oxygen transfer rates during IAS operation. *Bioremed. J.* 5:337-348.
- Central Valley Environmental, Inc., 2005. Appendix D - Zone 4 Remedial Investigation Report Perimeter Groundwater Operable Unit 5, Aerojet-General Superfund Site, Sacramento, CA.
- Costerton, J.W., J.C. Nickel, and T.I. Ladd. 1986. Suitable methods for the comparative study of free-living and surface-associated bacterial populations. *In* Bacteria in Nature, Volume II, Methods and Special Applications in Bacterial Ecology. Poindester, J.S., Leadbetter, E. R., (Eds) Plenum Press, New York.
- Envirogen, Inc. 2003. ESTCP Final Report: In Situ Remediation of MTBE Contaminated Aquifers Using Propane Biostimulation. January 2003, 244 pp.
- Fleming, E.C., J.C. Pennington, B.G. Wachob, R.A. Howe, and D.O. Hill. 1996. Removal of n-nitrosodimethylamine from waters using physical-chemical techniques. *J. Haz. Mat.* 51:151-164.
- Fournier, D., J. Hawari, S.H. Streger, K. McClay, and P.B. Hatzinger. 2009. Aerobic Biodegradation of N-nitrosodimethylamine (NDMA) by the propanotroph *Rhodococcus ruber* ENV425. *Appl. Environ. Microbiol.* 75:5088-5093
- FRTR. 1998. Guide to Documenting and Managing Cost and Performance Information for Remediation Projects, Revised Version. EPA 542-B-98-007. Online: <http://www.epa.gov/tio/download/frtr/costperf98.pdf>.
- Hackel, O. 1966. Summary of the Geology of the Great Valley. *In* E.H. Bailey (Ed.). Geology of Northern California, California Division of Mines and Geology Bulletin, 190:217-238.

- Hatzinger, P.B., S.H. Streger, and J.F. Begley. 2015. Enhancing aerobic biodegradation of 1,2-dibromoethane in groundwater using ethane or propane and inorganic nutrients. *J. Contam. Hydrol.* 172:61-70.
- Hatzinger, P.B., and J.F. Begley. 2014. Final Project Report: Enhanced *In Situ* Bioremediation of 1,2-Dibromoethane (EDB) at Joint Base Cape Cod. AFCEC Contract FA8903-11-C-8003, BAA Project 576. October 2014.
- Hatzinger, P., and T. Webster. 2014. Treatment of N-Nitrosodimethylamine (NDMA) in Groundwater Using a Fluidized Bed Reactor. Final Report for ESTCP Project ER-200829. Online:<https://www.serdp-estcp.org/Program-Areas/Environmental-Restoration/Contaminated-Groundwater/Emerging-Issues/ER-200829>.
- Hatzinger, P.B., C. Condee, K.R. McClay, and A.P. Togna. 2011. Aerobic treatment of N-nitrosodimethylamine in a propane-fed membrane bioreactor. *Water Res.* 45:254-262.
- Hatzinger, P.B. 2010. Treatability Study Report: Field Demonstration of Propane Biosparging for *In Situ* Remediation of N-nitrosodimethylamine in Groundwater. ESTCP Project ER-0828. August 30, 2010, 57 pp.
- Hatzinger, P.B., J. Hawari, and D. Fournier. 2008. Bioremediation Approaches for Treating Low Concentrations of N-nitrosodimethylamine (NDMA) in Groundwater. Strategic Environmental Research and Development Program Final Report, SERDP Project ER-1456., 131 pp. Online: <http://www.estcp.org/viewfile.cfm?Doc=ER%2D1456%2DFR%2Epdf>.
- Hazen, T.C., K.H. Lombard, B.B. Looney, M.V. Enzien, J.M. Dougherty, C.B. Fliermans, J. Wear, and C.A. Eddy-Dilek. 1994. Summary of *In Situ* Bioremediation Demonstration (Methane Biostimulation) via Horizontal Wells at the Savannah River Site Integrated Demonstration Project. pp. 137-150, *In The 33rd Hanford Symposium on Health and the Environment In Situ Remediation: Scientific Basis for Current and Future Technologies*. November 7-11.
- Hazen, T.C., L. Jimenez, G.L. de Victoria, and C.B. Fliermans. 1991. Comparison of bacteria from deep subsurface sediment and adjacent groundwater. *Microb. Ecol.* 22:293-304.
- Hopkins, G.D., and P.L. McCarty. 1995. Field evaluation of *in situ* aerobic cometabolism of trichloroethylene and three dichloroethylene isomers using phenol and toluene as the primary substrates. *Environ. Sci. Technol.* 29:1628-1637.
- Johnson, R.L., P.C. Johnson, I.L. Amerson, T.L. Johnson, C.L. Bruce, A. Leeson, and C.M. Vogel. 2001. Diagnostic tools for integrated *in situ* air sparging pilot tests. *Bioremed. J.* 5:283-298.
- Krug, T.A., C. Wolfe, R.D. Norris, and C.J. Winstead. 2009. Cost analysis of *in situ* perchlorate bioremediation technologies. *In* H.F. Stroo and C.H. Ward (Eds.), *In Situ Bioremediation of Perchlorate in Groundwater*, p. 199-218, SERDP ESTCP Environmental Remediation Technology. Springer.
- Leeson, A., E. Becvar, B. Henry, J. Fortenberry, and C. Coyle. 2004. Principles and Practices of Enhanced Anaerobic Bioremediation of Chlorinated Solvents. NAVFAC Technical Report TR-2250-ENV. Available online: <http://www.dtic.mil/dtic/tr/fulltext/u2/a511850.pdf>.

- Leeson, A., P.C. Johnson, R.L. Johnson, C.M. Vogel, R.E. Hinchee, M. Marley, T. Peargin, C.L. Bruce, I.L. Amerson, C.T. Coonfare, R.D. Gillespie, and D.B. McWhorter. 2002. Air Sparging Design Paradigm. Battelle, Columbus, OH. 150 pp.
- Lippincott, D., S.H. Streger, C.E. Schaefer, J. Hinkle, J. Stormo, and R.J. Steffan. 2015. Bioaugmentation and propane biosparging for *in situ* biodegradation of 1,4-dioxane. *Ground Water Monit. Remed.* 35:81-92.
- MADEP. 2015. Massachusetts Department of Environmental Protection. Current Regulatory Limit: n-Nitrosodimethylamine (NDMA). Online: <http://www.mass.gov/eea/agencies/massdep/water/drinking/standards/n-nitrosodimethylamine-ndma.html>.
- McCarty, P.L., M.N. Goltz, G.D. Hopkins, M.E. Dolan, J.P. Allan, B.T. Kawakami, and T.J. Carrothers. 1998. Full-scale evaluation of *in situ* co-metabolic degradation of trichloroethylene in groundwater through toluene injection. *Environ. Sci. Technol.* 32:88-100.
- Mitch, W.A., and D.L. Sedlak. 2002a. Formation of N-nitrosodimethylamine (NDMA) from dimethylamine during chlorination. *Environ. Sci. Technol.* 36:588-595.
- Mitch, W.A., and D.L. Sedlak. 2002b. Factors controlling nitrosamine formation during wastewater chlorination. *Water Sci. Technol.: Water Supply* 2:191-198.
- Mitch, W.A., J.O. Sharp, R.R. Trussell, R.L. Valentine, L. Alvarez-Cohen, and D.L. Sedlak. 2003. N-nitrosodimethylamine (NDMA) as a drinking water contaminant: a review. *Environ. Eng. Sci.* 20: 389-404.
- OEHHA. 2006. Public Health Goals for Contaminants in Drinking Water; N-Nitrosodimethylamine. Pesticide and Environmental Toxicology Branch, Office of Environmental Health Hazard Assessment, California Environmental Protection Agency, December, 2006. 60 pp.
- Oldenhuis, R., R.L. Vink, D.B. Janssen, and B. Witholt. 1989. Degradation of chlorinated aliphatic hydrocarbons by *Methylosinus trichosporium* OB3b expressing soluble methane monooxygenase. *Appl. Environ. Microbiol.* 55:2819-2826.
- Puls, R.W., and M.J. Barcelona. 1996. Low-flow (minimal drawdown) ground-water sampling procedures. EPA/540/S-95/504. Online: <http://nepis.epa.gov/Adobe/PDF/2000G23N.PDF>.
- Schaefer, C.E., D.R. Lippincott, and R.J. Steffan. 2010. Field-scale evaluation of bioaugmentation dosage for treating chlorinated ethenes. *Ground Water Monit. Remed.* 30:113-124.
- Schaefer, C.E., M.E. Fuller, C.W. Condee, J.M. Lowey, and P.B. Hatzinger. 2007. Comparison of biotic and abiotic treatment approaches for co-mingled perchlorate, nitrate, and nitramine explosives in groundwater. *J. Contaminant Hydrol.* 89:231-250.
- Schmidt, S.K., M. Alexander, and M.L. Shuler. 1985. Predicting threshold concentrations of organic substrates for bacterial growth. *J. Theor. Biol.* 114:1-8.
- Sedlak, D.L., R.A. Deeb, E.L. Hawley, W.A. Mitch, T.D. Durbin, S. Mowbray, and S. Carr. 2005. Sources and fate of nitrosodimethylamine and its precursors in municipal wastewater treatment plants. *Water Environ. Res.* 77:32-39.
- Semprini, L., G.D. Hopkins, D. Grbic-Galic, P.L. McCarty, and P.V. Roberts. 1994. A laboratory and field evaluation of enhanced *in situ* bioremediation of trichloroethylene, *cis*- and *trans*-

- dichloroethylene, and vinyl chloride by methanotrophic bacteria. pp. 383-412. *In* Bioremediation: Field Experience, P. E. Flathman, D.E. Jerger, and J.H. Exner (Eds.). Lewis Publishers, Boca Raton.
- Semprini, L, and P.L. McCarty. 1991. Comparison between model simulations and field results for in-situ bioremediation of chlorinated aliphatics: part 1. biostimulation of methanotrophic bacteria. *Ground Water* 29:365-374.
- Sharp, J.O., C.M. Sales, and L. Alvarez-Cohen. 2010. Functional characterization of propane-enhanced N-nitrosodimethylamine degradation by two Actinomycetes. *Biotechnol. Bioeng.* 107:924-932.
- Sharp, J.O., C.M. Sales, J.C. LeBlanc, J. Liu, T.K. Wood, L.D. Eltis, W.W. Mohn, and L. Alvarez-Cohen. 2007. An inducible propane monooxygenase is responsible for N-nitrosodimethylamine degradation by *Rhodococcus* sp. strain RHA1. *Appl. Environ. Microbiol.* 73:6930-6938.
- Sharp, J.O., T.K. Wood, and L. Alvarez-Cohen. 2005. Aerobic biodegradation of N-Nitrosodimethylamine (NDMA) by axenic bacterial strains. *Biotechnol. Bioeng.* 89:608-618.
- Shaw Environmental, Inc. 2013. Final Report: In Situ Treatment of N-Nitrosodimethylamine (NDMA) in Groundwater. Former Air Force Plant PJKS, Waterton Canyon, Colorado. AFCEC Contract FA8903-09-C-8022. August 15, 2013.
- Stefan, M.I., and J.R. Bolton. 2002. UV direct photolysis of N-nitrosodimethylamine (NDMA): Kinetic and product study. *Helvetica Chimica Acta.* 85:1416-1426.
- Steffan, R. J., Y. Farhan, C.W. Condee, and S. Drew. 2003. Bioremediation at a New Jersey Site Using Propane-Oxidizing Bacteria. pp. 503-516. In: E. Moyer and P. Kosteci (Eds.). Chapter 27: MTBE Remediation Handbook, Amherst Scientific Publisher, Amherst, MA.
- Steffan, R.J., K. McClay, S. Vainberg, C.W. Condee, and D. Zhang. 1997. Biodegradation of the gasoline oxygenates methyl tert-butyl ether, ethyl tert-butyl ether, and tert-amyl methyl ether by propane-oxidizing bacteria. *Appl. Environ. Microbiol.* 63:4216-4222.
- Stroo, H.F., and C.H. Ward (Eds.). 2009. *In Situ* Bioremediation of Perchlorate in Groundwater. SERDP ESTCP Environmental Remediation Technology. Springer, New York.
- SWRCB, State Water Resources Control Board. 2015a. Groundwater Information Sheet: N-Nitrosodimethylamine. Online: <http://www.swrcb.ca.gov/gama/docs/ndma.pdf>.
- SWRCB, State Water Resources Control Board, 2015b. Drinking Water Notification Levels and Response Levels: An Overview. Online: [http://www.waterboards.ca.gov/drinking\\_water/certlic/drinkingwater/documents/notificationlevels/notificationlevels.pdf](http://www.waterboards.ca.gov/drinking_water/certlic/drinkingwater/documents/notificationlevels/notificationlevels.pdf).
- Tetra Tech, 2008. Supplemental Remedial Investigation/Feasibility Study Field Sampling Plan for Eastern Operable Unit (Operable Unit 8). Aerojet Superfund Site. Report prepared for Aerojet General by Tetra Tech, inc., Rancho Cordova, CA. September, 30.
- Tovanabootr, A., L. Semprini, M.E. Dolan, M. Azizian, V.S. Magar, D. Debacker, A. Leeson, and C.D. Kempisty. 2001. Co-metabolic air sparging field demonstration with propane to remediate trichloroethene and cis-dichloroethene. pp. 145-153. Sixth International *In Situ* and On Site Bioremediation Symposium; San Diego, CA; USA; 4-7 June 2001.

- USEPA. 2011a. N-nitrosodimethylamine (CASRN 62-75-9). Integrated Risk Information Service (IRIS) Substance File. Online: <http://www.epa.gov/iris/subst/0045.htm>.
- USEPA. 2011b. High Global Warming potential (GWP) Gases. Online: <http://www.epa.gov/highgwp1/scientific.html>
- USEPA, 2008. Emerging Contaminant – N-Nitroso-dimethylamine (NDMA). Fact Sheet. EPA505-F-09-008. Solid Waste and Emergency Response (5106P). Online: <http://www.clu-in.org/download/contaminantfocus/epa505f09008.pdf>.
- USEPA. 1994. Biosparging. *In* How to Evaluate Alternative Cleanup Technologies for Underground Storage Tank Sites: A Guide for Corrective Action Plan Reviewers. (EPA 510-B-95-007). Online: [http://www.epa.gov/OUST/pubs/tum\\_ch8.pdf](http://www.epa.gov/OUST/pubs/tum_ch8.pdf).
- Webster, T.S., C. Condee, and P.B. Hatzinger. 2013. *Ex situ* treatment of N-nitrosodimethylamine (NDMA) in groundwater using a fluidized bed reactor. *Water Res.* 811-820.
- Wilson, J.T., and B.H. Wilson. 1985. Biotransformation of trichloroethylene in soil. *Appl. Environ. Microbiol.* 29:242-243.



# APPENDICES

## Appendix A: Points of Contact

| POINT OF CONTACT<br>Name | ORGANIZATION<br>Name<br>Address  | Phone<br>Fax<br>E-mail  | Role in Project                                       |
|--------------------------|--|---|---|
| Paul B. Hatzinger        | CB&I Federal Services,<br>LLC Inc.<br>17 Princess Road<br>Lawrenceville, NJ 08648                | 609-895-5356 direct<br>267-337-4003 cell<br>609-895-1858 fax<br>Paul.hatzinger@cbifederalservices.com       | Principal Investigator                                |
| Scott L. Neville         | Aerojet General Corp.<br>P.O. Box 13222 / Dept<br>0330 / MS 5519<br>Sacramento, CA<br>95813-6000 | 916.355.5500 direct<br>916-837-7350 cell<br>916-355-6145 fax<br>scott.neville@aerojet.com                   | Aerojet POC &<br>Project Manager                      |
| David Lippincott         | CB&I Environmental,<br>Inc.<br>17 Princess Road<br>Lawrenceville, NJ 08648                       | 609-895-5380 direct<br>609-605-0883 cell<br>609-895-1858 fax<br>David.lippincott@<br>cbifederalservices.com | CB&I Project Field<br>Manager                         |
| Andrea Leeson            | SERDP/ESTCP<br>901 N Stuart Street,<br>Suite 303<br>Arlington VA 22203                           | 703-696-2118 direct<br>703-696-2114 fax<br>Andrea.Leeson@osd.mil  | ESTCP Environmental<br>Restoration Program<br>Manager |
| Alexander MacDonald      | Central Valley RWQCB<br>3443 Routier Road,<br>Suite A, Sacramento, CA<br>95827-3003              | 916-464-4625 direct<br>amacdonald@waterboards.ca.gov  | Regulatory review and<br>oversight at Aerojet Site    |

## **Appendix B: Analytical Results**

**PMW-1: ANALYTICAL DATA SUMMARY**

ESTCP-Aerojet

| Sample ID                   | PMW-1       | PMW-1       | PMW-1       | PMW-1       | PMW-1       | PMW-1       | PMW-1         | PMW-1         | PMW-1           | PMW-1        | PMW-1        | PMW-1                    | PMW-1         | PMW-1         | PMW-1        | PMW-1        | PMW-1         | PMW-1                  | PMW-1         | PMW-1         | PMW-1         | PMW-1         | PMW-1        | PMW-1        |
|-----------------------------|-------------|-------------|-------------|-------------|-------------|-------------|---------------|---------------|-----------------|--------------|--------------|--------------------------|---------------|---------------|--------------|--------------|---------------|------------------------|---------------|---------------|---------------|---------------|--------------|--------------|
| Lab Sample No.              | 8485-3      | 8489-2      | 8489-8      | 8493-2      | 8498-3      | 8502-2      | 8549-8        | 8555-4        |                 |              |              |                          |               |               |              |              |               |                        |               |               |               |               |              |              |
| Sampling Date               | 6/28/2011   | 7/1/2011    | 7/5/2011    | 7/11/2011   | 7/26/2011   | 7/28/2011   | 11/22/2011    | 12/5/2011     | 2/7/2012        | 2/8/2012     | 2/9/2012     | 2/27/2012                | 3/15/2012     | 6/4/2012      | 6/25/2012    | 7/23/2012    | 8/16/2012     | 9/13/2012              | 10/11/2012    | 11/26/2012    | 12/20/2012    | 1/31/2013     | 3/4/2013     | 4/18/2013    |
| Days                        |             |             |             |             |             |             | -83           | -70           | -6              | -5           | -4           | 14                       | 31            | 112           | 133          | 161          | 185           | 213                    | 241           | 287           | 311           | 353           | 385          | 430          |
| Matrix                      | Water       | Water       | Water       | Water       | Water       | Water       | Water         | Water         | Water           | Water        | Water        | Water                    | Water         | Water         | Water        | Water        | Water         | Water                  | Water         | Water         | Water         | Water         | Water        | Water        |
| NDMA (EPA 521)              | ng/L        | ng/L        | ng/L        | ng/L        | ng/L        | ng/L        | ng/L          | ng/L          | ng/L            | ng/L         | ng/L         | ng/L                     | ng/L          | ng/L          | ng/L         | ng/L         | ng/L          | ng/L                   | ng/L          | ng/L          | ng/L          | ng/L          | ng/L         | ng/L         |
| NDMA                        | NS          | NS          | NS          | NS          | NS          | NS          | <b>18000</b>  | <b>19000</b>  | NS              | NS           | NS           | NS                       | NS            | <b>2300</b>   | NS           | <b>420</b>   | <b>10</b> U   | <b>130<sup>a</sup></b> | <b>550</b>    | <b>160</b>    | <b>330</b>    | <b>60</b>     | <b>1300</b>  | <b>7500</b>  |
| REDUCED GASES (GC)          | µg/L        | µg/L        | µg/L        | µg/L        | µg/L        | µg/L        | µg/L          | µg/L          | µg/L            | µg/L         | µg/L         | µg/L                     | µg/L          | µg/L          | µg/L         | µg/L         | µg/L          | µg/L                   | µg/L          | µg/L          | µg/L          | µg/L          | µg/L         | µg/L         |
| Methane                     | NS          | NS          | NS          | NS          | NS          | NS          | <b>1.41</b> J | <b>0.73</b> J | NS              | NS           | NS           | NS                       | <b>0.75</b> J | <b>0.80</b> J | 2.0 U        | NS           | 2.0 U         | 2.0 U                  | 2.0 U         | 2.0 U         | 2.0 U         | <b>0.89</b> J | 2.0 U        | 2.0 U        |
| Ethane                      | NS          | NS          | NS          | NS          | NS          | NS          | 4.0 U         | 4.0 U         | NS              | NS           | NS           | NS                       | <b>3.36</b> J | <b>1.91</b> J | 4.0 U        | NS           | 4.0 U         | 4.0 U                  | 4.0 U         | 4.0 U         | 4.0 U         | <b>1.69</b> J | 4.0 U        | 4.0 U        |
| Ethene                      | NS          | NS          | NS          | NS          | NS          | NS          | 5.0 U         | 5.0 U         | NS              | NS           | NS           | NS                       | 5.0 U         | 5.0 U         | 5.0 U        | NS           | 5.0 U         | 5.0 U                  | 5.0 U         | 5.0 U         | 5.0 U         | 5.0 U         | 5.0 U        | 5.0 U        |
| Propane                     | NS          | NS          | NS          | NS          | NS          | NS          | 6.0 U         | 6.0 U         | NS              | NS           | NS           | NS                       | <b>299</b>    | <b>386</b>    | <b>948</b>   | NS           | <b>574</b>    | <b>487</b>             | <b>82.8</b>   | <b>562</b>    | <b>160</b>    | <b>627</b>    | <b>242</b>   | 6.0 U        |
| ANIONS                      | mg/L        | mg/L        | mg/L        | mg/L        | mg/L        | mg/L        | mg/L          | mg/L          | mg/L            | mg/L         | mg/L         | mg/L                     | mg/L          | mg/L          | mg/L         | mg/L         | mg/L          | mg/L                   | mg/L          | mg/L          | mg/L          | mg/L          | mg/L         | mg/L         |
| Chloride                    | <b>10.1</b> | <b>9.19</b> | <b>9.19</b> | <b>9.11</b> | <b>10.1</b> | <b>9.12</b> | <b>9.90</b>   | <b>8.38</b>   | NS              | NS           | NS           | <b>9.08</b>              | <b>8.82</b>   | NS            | NS           | <b>8.86</b>  | <b>8.87</b>   | <b>8.85</b>            | <b>8.80</b>   | <b>9.19</b>   | <b>8.72</b>   | <b>9.44</b>   | <b>9.15</b>  | <b>9.31</b>  |
| Nitrite as N                | 0.4 U       | 1.0 U       | 1.0 U       | 1.0 U       | 0.2 U       | 0.2 U       | 0.4 U         | 0.4 U         | NS              | NS           | NS           | 0.4 U                    | 0.2 U         | NS            | NS           | 0.4 U        | 0.4 U         | 0.4 U                  | 0.4 U         | 0.4 U         | 0.4 U         | 0.2 U         | 0.2 U        | 0.2 U        |
| Sulfate as SO <sub>4</sub>  | <b>15.1</b> | <b>14.5</b> | <b>14.8</b> | <b>14.7</b> | <b>13.9</b> | <b>14.4</b> | <b>16.2</b>   | <b>13.8</b>   | NS              | NS           | NS           | <b>15.5</b>              | <b>15.2</b>   | NS            | NS           | <b>14.4</b>  | <b>14.2</b>   | <b>14.0</b>            | <b>13.7</b>   | <b>13.1</b>   | <b>13.4</b>   | <b>19.7</b>   | <b>14.8</b>  | <b>13.6</b>  |
| Bromide                     | 0.4 U       | 1.0 U       | 1.0 U       | 1.0 U       | <b>0.61</b> | 0.2 U       | 0.4 U         | 0.4 U         | NS              | NS           | NS           | 0.4 U                    | <b>0.12</b>   | NS            | NS           | 0.4 U        | 0.4 U         | 0.4 U                  | 0.4 U         | 0.4 U         | 0.4 U         | 0.2 U         | 0.2 U        | 0.2 U        |
| Nitrate as N                | <b>2.17</b> | <b>1.97</b> | <b>2.13</b> | <b>2.26</b> | <b>2.55</b> | <b>2.60</b> | <b>1.93</b>   | <b>1.73</b>   | NS              | NS           | NS           | <b>2.28</b>              | <b>2.10</b>   | NS            | NS           | <b>0.46</b>  | <b>0.38</b> J | <b>0.27</b> J          | <b>0.13</b> J | <b>0.27</b> J | <b>0.13</b> J | <b>0.32</b> J | 0.2 U        | <b>0.28</b>  |
| O-Phosphate as P            | 0.4 U       | 1.0 U       | 1.0 U       | 1.0 U       | 0.2 U       | 0.2 U       | 0.4 U         | 0.4 U         | NS              | NS           | NS           | 0.4 U                    | 0.2 U         | NS            | NS           | 0.4 U        | 0.4 U         | 0.4 U                  | 0.4 U         | 0.4 U         | 0.2 U         | 0.2 U         | 0.2 U        | 0.2 U        |
| <b>FIELD PARAMETERS</b>     |             |             |             |             |             |             |               |               |                 |              |              |                          |               |               |              |              |               |                        |               |               |               |               |              |              |
| pH (SU)                     | NS          | NS          | NS          | NS          | NS          | NS          | <b>6.54</b>   | <b>6.60</b>   | <b>7.04</b>     | <b>6.59</b>  | <b>6.64</b>  | <b>7.41</b>              | <b>7.13</b>   | <b>6.70</b>   | NS           | <b>7.33</b>  | <b>6.62</b>   | <b>7.45</b>            | <b>7.16</b>   | <b>7.12</b>   | <b>7.02</b>   | <b>7.05</b>   | <b>6.61</b>  | <b>6.38</b>  |
| Temperature (°C)            | NS          | NS          | NS          | NS          | NS          | NS          | <b>12.79</b>  | <b>13.01</b>  | <b>14.51</b>    | <b>15.81</b> | <b>15.76</b> | <b>16.29</b>             | <b>15.81</b>  | <b>17.39</b>  | NS           | <b>17.96</b> | <b>18.43</b>  | <b>17.88</b>           | <b>17.35</b>  | <b>14.31</b>  | <b>14.40</b>  | <b>14.18</b>  | <b>14.37</b> | <b>14.41</b> |
| Dissolved Oxygen (DO; mg/L) | NS          | NS          | NS          | NS          | NS          | NS          | <b>1.33</b>   | <b>3.40</b>   | <b>4.69</b>     | <b>0.61</b>  | <b>0.37</b>  | <b>18.51<sup>*</sup></b> | <b>20.47</b>  | <b>13.77</b>  | <b>10.20</b> | <b>14.14</b> | <b>13.51</b>  | <b>12.62</b>           | <b>10.98</b>  | <b>15.60</b>  | <b>10.81</b>  | <b>10.36</b>  | <b>1.65</b>  | <b>0.53</b>  |
| Redox Potential (ORP; mV)   | NS          | NS          | NS          | NS          | NS          | NS          | <b>131.7</b>  | <b>91.3</b>   | <b>92.2</b>     | <b>102.8</b> | <b>127.6</b> | <b>192.9</b>             | <b>240.9</b>  | <b>124</b>    | NS           | <b>-73.3</b> | <b>233.8</b>  | <b>110.6</b>           | <b>115.1</b>  | <b>419.6</b>  | <b>489.6</b>  | <b>127.4</b>  | <b>125.8</b> | <b>19.7</b>  |
| Conductivity (µS/cm)        | NS          | NS          | NS          | NS          | NS          | NS          | <b>245</b>    | <b>244</b>    | <b>239</b>      | <b>459</b>   | NS           | <b>161</b>               | <b>138</b>    | <b>236</b>    | NS           | <b>192</b>   | <b>199</b>    | <b>233</b>             | <b>209</b>    | <b>212</b>    | <b>186</b>    | <b>215</b>    | <b>223</b>   | <b>216</b>   |
| Depth to Water (ft-bloc)    | NS          | NS          | NS          | NS          | NS          | NS          | <b>10.02</b>  | <b>10.35</b>  | <b>10.46</b>    | <b>9.44</b>  | <b>10.92</b> | <b>13.41</b>             | <b>14.16</b>  | <b>15.39</b>  | <b>12.21</b> | <b>15.04</b> | <b>11.18</b>  | <b>13.60</b>           | <b>14.56</b>  | <b>14.09</b>  | <b>14.10</b>  | <b>13.48</b>  | <b>12.61</b> | <b>12.27</b> |
| <b>Microbiology</b>         | cfu/mL      | cfu/mL      | cfu/mL      | cfu/mL      | cfu/mL      | cfu/mL      | cfu/mL        | cfu/mL        | cfu/mL          | cfu/mL       | cfu/mL       | cfu/mL                   | cfu/mL        | cfu/mL        | cfu/mL       | cfu/mL       | cfu/mL        | cfu/mL                 | cfu/mL        | cfu/mL        | cfu/mL        | cfu/mL        | cfu/mL       | cfu/mL       |
| Propane Monoxygenase        | NS          | NS          | NS          | NS          | NS          | NS          | NS            | NS            | <b>1.62E+04</b> | NS           | NS           | NS                       | NS            | NS            | NS           | NS           | NS            | NS                     | NS            | NS            | NS            | NS            | NS           | NS           |

**BOLD** value indicates the compound was detected above the reporting limit.

U - The compound was not detected at the indicated PQL concentration.

J - The compound is present at a concentration less than the quantitation limit but greater than zero. The reported concentration is an estimate.

NS - Not Sampled

<sup>\*</sup>Value calculated based on water temperature and atmospheric pressure

<sup>a</sup>Value had unacceptable surrogate recoveries

PMW-2: ANALYTICAL DATA SUMMARY

| Sample ID                   | PMW-2     | PMW-2    | PMW-2    | PMW-2     | PMW-2     | PMW-2     | PMW-2      | PMW-2     | PMW-2    | PMW-2    | PMW-2    | PMW-2     | PMW-2     | PMW-2     | PMW-2    | PMW-2    | PMW-2     | PMW-2     | PMW-2    | PMW-2     | PMW-2     | PMW-2     | PMW-2      | PMW-2      | PMW-2      | PMW-2     | PMW-2    | PMW-2     |        |      |      |      |      |      |      |      |     |     |     |     |     |     |     |     |    |     |   |  |
|-----------------------------|-----------|----------|----------|-----------|-----------|-----------|------------|-----------|----------|----------|----------|-----------|-----------|-----------|----------|----------|-----------|-----------|----------|-----------|-----------|-----------|------------|------------|------------|-----------|----------|-----------|--------|------|------|------|------|------|------|------|-----|-----|-----|-----|-----|-----|-----|-----|----|-----|---|--|
| Lab Sample No.              | 8485-4    | 8489-4   | 8489-10  | 8493-3    | 8498-4    | 8502-3    | 8549-7     | 8555-5    |          |          |          |           |           |           |          |          |           |           |          |           |           |           |            |            |            |           |          |           |        |      |      |      |      |      |      |      |     |     |     |     |     |     |     |     |    |     |   |  |
| Sampling Date               | 6/28/2011 | 7/1/2011 | 7/5/2011 | 7/11/2011 | 7/26/2011 | 7/28/2011 | 11/22/2011 | 12/5/2011 | 2/7/2012 | 2/8/2012 | 2/9/2012 | 2/27/2012 | 3/15/2012 | 3/26/2012 | 5/7/2012 | 6/4/2012 | 6/25/2012 | 6/26/2012 | 7/9/2012 | 7/23/2012 | 8/16/2012 | 9/13/2012 | 10/11/2012 | 11/26/2012 | 12/20/2012 | 1/31/2013 | 3/4/2013 | 4/18/2013 |        |      |      |      |      |      |      |      |     |     |     |     |     |     |     |     |    |     |   |  |
| Days                        |           |          |          |           | -83       | -70       | -6         | -5        | 4        | 4        | 14       | 31        | 42        | 84        | 112      | 133      | 134       | 147       | 161      | 185       | 213       | 241       | 267        | 311        | 353        | 365       | 430      |           |        |      |      |      |      |      |      |      |     |     |     |     |     |     |     |     |    |     |   |  |
| Matrix                      | Water     | Water    | Water    | Water     | Water     | Water     | Water      | Water     | Water    | Water    | Water    | Water     | Water     | Water     | Water    | Water    | Water     | Water     | Water    | Water     | Water     | Water     | Water      | Water      | Water      | Water     | Water    | Water     |        |      |      |      |      |      |      |      |     |     |     |     |     |     |     |     |    |     |   |  |
| NDMA (EPA 521)              | ng/L      | ng/L     | ng/L     | ng/L      | ng/L      | ng/L      | ng/L       | ng/L      | ng/L     | ng/L     | ng/L     | ng/L      | ng/L      | ng/L      | ng/L     | ng/L     | ng/L      | ng/L      | ng/L     | ng/L      | ng/L      | ng/L      | ng/L       | ng/L       | ng/L       | ng/L      | ng/L     | ng/L      |        |      |      |      |      |      |      |      |     |     |     |     |     |     |     |     |    |     |   |  |
| NDMA                        | NS        | NS       | NS       | NS        | NS        | NS        | 20000      | 25000     | NS       | NS       | NS       | NS        | NS        | 11000     | 21000    | NS       | NS        | NS        | NS       | 9000*     | 12000     | 3700      | 630        | 130        | 7.8        | 2.7       | J        | 3.4       | 280    |      |      |      |      |      |      |      |     |     |     |     |     |     |     |     |    |     |   |  |
| REDUCED GASES (GC)          | µg/L      | µg/L     | µg/L     | µg/L      | µg/L      | µg/L      | µg/L       | µg/L      | µg/L     | µg/L     | µg/L     | µg/L      | µg/L      | µg/L      | µg/L     | µg/L     | µg/L      | µg/L      | µg/L     | µg/L      | µg/L      | µg/L      | µg/L       | µg/L       | µg/L       | µg/L      | µg/L     | µg/L      |        |      |      |      |      |      |      |      |     |     |     |     |     |     |     |     |    |     |   |  |
| Methane                     | NS        | NS       | NS       | NS        | NS        | NS        | 0.73       | J         | 0.73     | J        | NS       | NS        | NS        | 2.0       | U        | 0.92     | J         | 0.73      | J        | 0.54      | J         | 2.0       | U          | NS         | U          | 2.0       | U        | 2.0       | U      | 2.0  | U    | 2.0  | U    | 2.0  | U    | 0.59 | J   | 2.0 | U   | 2.0 | U   | 2.0 | U   |     |    |     |   |  |
| Ethane                      | NS        | NS       | NS       | NS        | NS        | NS        | 4.0        | U         | 4.0      | U        | NS       | NS        | NS        | 4.0       | U        | 4.0      | U         | 4.0       | U        | 4.0       | U         | 4.0       | U          | NS         | U          | 4.0       | U        | 4.0       | U      | 4.0  | U    | 4.0  | U    | 4.0  | U    | 4.0  | U   | 4.0 | U   | 4.0 | U   | 4.0 | U   | 4.0 | U  |     |   |  |
| Ethene                      | NS        | NS       | NS       | NS        | NS        | NS        | 5.0        | U         | 5.0      | U        | NS       | NS        | NS        | 5.0       | U        | 5.0      | U         | 5.0       | U        | 5.0       | U         | NS        | U          | 5.0        | U          | 5.0       | U        | 5.0       | U      | 5.0  | U    | 5.0  | U    | 5.0  | U    | 5.0  | U   | 5.0 | U   | 5.0 | U   | 5.0 | U   | 5.0 | U  | 5.0 | U |  |
| Propane                     | NS        | NS       | NS       | NS        | NS        | NS        | 6.0        | U         | 6.0      | U        | NS       | NS        | NS        | 60.5      | 18.3     | 6.0      | U         | 6.0       | U        | 6.0       | U         | NS        | U          | 508        | 64.7       | 18.6      | 6.0      | U         | 6.0    | U    | 406  | 584  | 528  | 231  | 6.0  | U    | 6.0 | U   | 6.0 | U   | 6.0 | U   | 6.0 | U   |    |     |   |  |
| ANIONS                      | mg/L      | mg/L     | mg/L     | mg/L      | mg/L      | mg/L      | mg/L       | mg/L      | mg/L     | mg/L     | mg/L     | mg/L      | mg/L      | mg/L      | mg/L     | mg/L     | mg/L      | mg/L      | mg/L     | mg/L      | mg/L      | mg/L      | mg/L       | mg/L       | mg/L       | mg/L      | mg/L     | mg/L      | mg/L   |      |      |      |      |      |      |      |     |     |     |     |     |     |     |     |    |     |   |  |
| Chloride                    | 9.69      | 13.6     | 11.79    | 9.87      | 10.1      | 9.49      | 9.78       | 8.56      | NS       | NS       | NS       | 9.54      | 8.46      | 8.86      | 8.39     | NS       | NS        | NS        | NS       | 9.13      | 8.66      | 9.07      | 9.39       | 10.50      | 8.55       | 9.16      | 9.76     | 9.17      |        |      |      |      |      |      |      |      |     |     |     |     |     |     |     |     |    |     |   |  |
| Nitrite as N                | 0.4       | U        | 1.0      | U         | 1.0       | U         | 1.0        | U         | 0.2      | U        | 0.2      | U         | 0.4       | U         | 0.4      | U        | 0.2       | U         | 0.2      | U         | NS        | NS        | NS         | NS         | NS         | NS        | NS       | NS        | NS     | NS   | NS   | NS   | NS   | NS   | NS   | NS   | NS  | NS  | NS  | NS  | NS  | NS  | NS  | NS  | NS | NS  |   |  |
| Sulfate as SO <sub>4</sub>  | 16.4      | 12.6     | 16.3     | 15.1      | 13.7      | 13.8      | 16.5       | 14.8      | NS       | NS       | NS       | NS        | 15.1      | 13.6      | 14.5     | 13.4     | NS        | NS        | NS       | NS        | 16.0      | 15.5      | 14.8       | 14.8       | 11.5       | 17.4      | 21.1     | 16.1      | 15.6   |      |      |      |      |      |      |      |     |     |     |     |     |     |     |     |    |     |   |  |
| Bromide                     | 0.63      | 487      | 78.4     | 9.72      | 2.37      | 2.52      | 0.4        | U         | 0.4      | U        | NS       | NS        | NS        | 0.69      | 1.77     | 0.28     | 0.37      | NS        | NS       | NS        | NS        | NS        | NS         | NS         | 0.26       | J         | 0.34     | J         | 1.67   | 7.02 | 88.4 | 90.9 | 64.2 | 32.7 | 7.77 |      |     |     |     |     |     |     |     |     |    |     |   |  |
| Nitrate as N                | 2.32      | 2.39     | 2.49     | 2.58      | 2.91      | 2.96      | 2.23       | 1.86      | NS       | NS       | NS       | NS        | 2.00      | 1.89      | 1.89     | 1.77     | NS        | NS        | NS       | NS        | 1.63      | 1.48      | 0.28       | J          | 0.4        | U         | 0.4      | U         | 0.2    | U    | 0.2  | U    | 0.2  | U    | 0.2  | U    | 0.2 | U   | 0.2 | U   | 0.2 | U   | 0.2 | U   |    |     |   |  |
| O-Phosphate as P            | 0.4       | U        | 1.0      | U         | 1.0       | U         | 1.0        | U         | 0.2      | U        | 0.2      | U         | 0.4       | U         | 0.6      | U        | NS        | NS        | NS       | NS        | 0.4       | U         | 0.2        | U          | 0.2        | U         | 0.2      | U         | NS     | NS   | NS   | NS   | NS   | NS   | NS   | NS   | NS  | NS  | NS  | NS  | NS  | NS  | NS  | NS  | NS | NS  |   |  |
| FIELD PARAMETERS            |           |          |          |           |           |           |            |           |          |          |          |           |           |           |          |          |           |           |          |           |           |           |            |            |            |           |          |           |        |      |      |      |      |      |      |      |     |     |     |     |     |     |     |     |    |     |   |  |
| pH (SU)                     | NS        | NS       | NS       | NS        | NS        | NS        | 6.72       | 6.58      | 7.03     | 6.82     | 6.56     | 6.82      | 6.63      | 6.90      | 6.67     | 6.63     | NS        | NS        | 6.53     | 6.71      | 6.39      | 6.73      | 6.76       | 6.60       | 6.57       | 6.65      | 6.86     | 6.33      | 6.19   |      |      |      |      |      |      |      |     |     |     |     |     |     |     |     |    |     |   |  |
| Temperature (°C)            | NS        | NS       | NS       | NS        | NS        | NS        | 11.86      | 13.91     | 13.11    | 15.05    | 15.69    | 15.54     | 15.49     | 14.98     | 15.43    | 16.75    | NS        | NS        | 18.15    | 17.39     | 17.84     | 19.03     | 17.60      | 17.66      | 15.71      | 15.13     | 14.32    | 14.01     | 14.08  |      |      |      |      |      |      |      |     |     |     |     |     |     |     |     |    |     |   |  |
| Dissolved Oxygen (DO; mg/L) | NS        | NS       | NS       | NS        | NS        | NS        | 2.21       | 3.74      | 0.53     | 18.86    | 30.90    | 12.89*    | 10.91     | 7.80      | 17.07    | 10.66    | 8.22      | 12.59     | 12.99    | 12.39     | 14.75     | 12.04     | 11.37      | 13.49      | 11.29      | 10.29     | 9.46     | 1.46      |        |      |      |      |      |      |      |      |     |     |     |     |     |     |     |     |    |     |   |  |
| Redox Potential (ORP; mV)   | NS        | NS       | NS       | NS        | NS        | NS        | 78.7       | 72.4      | 95.1     | 131.7    | 182.1    | 137.9     | 230.7     | 75.2      | 242.7    | 124.9    | NS        | 22.7      | 103.1    | 60.4      | 231.2     | 137.6     | 128.1      | 416.9      | 449.8      | 141.0     | 123.3    | 131.2     |        |      |      |      |      |      |      |      |     |     |     |     |     |     |     |     |    |     |   |  |
| Conductivity (µS/cm)        | NS        | NS       | NS       | NS        | NS        | NS        | 249        | 244       | 181      | 420      | 428      | 242       | 209       | 290       | 419      | 176      | NS        | 180       | 178      | 211       | 219       | 220       | 211        | 265        | 324        | 311       | 209      | 238       |        |      |      |      |      |      |      |      |     |     |     |     |     |     |     |     |    |     |   |  |
| Depth to Water (ft-bloc)    | NS        | NS       | NS       | NS        | NS        | NS        | 6.38       | 6.53      | 6.70     | 7.43     | 4.71     | 8.66      | 7.63      | 7.71      | 7.32     | 8.10     | 7.08      | 8.97      | 9.31     | 10.51     | 10.42     | 10.51     | 12.19      | 10.59      | 10.96      | 10.74     | 9.51     | 8.33      |        |      |      |      |      |      |      |      |     |     |     |     |     |     |     |     |    |     |   |  |
| Microbiology                | cfu/mL    | cfu/mL   | cfu/mL   | cfu/mL    | cfu/mL    | cfu/mL    | cfu/mL     | cfu/mL    | cfu/mL   | cfu/mL   | cfu/mL   | cfu/mL    | cfu/mL    | cfu/mL    | cfu/mL   | cfu/mL   | cfu/mL    | cfu/mL    | cfu/mL   | cfu/mL    | cfu/mL    | cfu/mL    | cfu/mL     | cfu/mL     | cfu/mL     | cfu/mL    | cfu/mL   | cfu/mL    | cfu/mL |      |      |      |      |      |      |      |     |     |     |     |     |     |     |     |    |     |   |  |
| Propane Monooxygenase       | NS        | NS       | NS       | NS        | NS        | NS        | NS         | NS        | NS       | NS       | NS       | NS        | NS        | NS        | NS       | NS       | NS        | NS        | NS       | NS        | NS        | NS        | NS         | NS         | NS         | NS        | NS       | NS        | NS     | NS   | NS   | NS   | NS   | NS   | NS   | NS   | NS  | NS  | NS  | NS  | NS  | NS  | NS  | NS  | NS | NS  |   |  |

BOLD value indicates the compound was detected above the reporting limit.  
 U - The compound was not detected at the indicated PQL concentration.  
 J - The compound is present at a concentration less than the quantitation limit but greater than zero. The reported concentration is an estimate.  
 NS - Not Sampled  
 \*Value calculated based on water temperature and atmospheric pressure  
 †Data from duplicate reported due to matrix interference with regular sample



PMW-4: ANALYTICAL DATA SUMMARY

| Sample ID                   | PMW-4       | PMW-4       | PMW-4       | PMW-4         | PMW-4        | PMW-4        | PMW-4           | PMW-4    | PMW-4    | PMW-4    | PMW-4       | PMW-4         | PMW-4         | PMW-4           | PMW-4       | PMW-4     | PMW-4       | PMW-4       | PMW-4         | PMW-4       | PMW-4           | PMW-4         | PMW-4       | PMW-4           | PMW-4       | PMW-4       |                 |               |           |          |           |
|-----------------------------|-------------|-------------|-------------|---------------|--------------|--------------|-----------------|----------|----------|----------|-------------|---------------|---------------|-----------------|-------------|-----------|-------------|-------------|---------------|-------------|-----------------|---------------|-------------|-----------------|-------------|-------------|-----------------|---------------|-----------|----------|-----------|
| Lab Sample No.              | 8485-5      | 8489-3      | 8489-9      | 8493-5        | 8549-4       | 8555-3       |                 |          |          |          | 8621-4      | 8643-4        | 8648-6        | 8681-4          | 8703-4      |           | 8740-5      | 8749-3      | 8761-4        | 8796-5      | 8821-4          | 8846-4        | 8872-4      | 8887A-4         | 8901-4      | 8919-4      | 8950-4          |               |           |          |           |
| Sampling Date               | 6/28/2011   | 7/1/2011    | 7/5/2011    | 7/11/2011     | 11/21/2011   | 12/5/2011    | 2/7/2012        | 2/8/2012 | 2/9/2012 | 2/9/2012 | 2/27/2012   | 3/15/2012     | 3/28/2012     | 5/7/2012        | 6/4/2012    | 6/25/2012 | 6/26/2012   | 7/9/2012    | 7/23/2012     | 8/18/2012   | 8/21/2012       | 8/24/2012     | 8/27/2012   | 8/28/2012       | 9/13/2012   | 10/11/2012  | 11/26/2012      | 12/20/2012    | 1/31/2013 | 3/4/2013 | 4/18/2013 |
| Days                        |             |             |             |               | -84          | -70          | -6              | -5       | -4.5     | -4       | 14          | 31            | 42            | 84              | 112         | 133       | 134         | 147         | 161           | 165         | 213             | 241           | 287         | 311             | 353         | 385         | 430             |               |           |          |           |
| Matrix                      | Water       | Water       | Water       | Water         | Water        | Water        | Water           | Water    | Water    | Water    | Water       | Water         | Water         | Water           | Water       | Water     | Water       | Water       | Water         | Water       | Water           | Water         | Water       | Water           | Water       | Water       | Water           | Water         | Water     |          |           |
| NDMA (EPA 521)              | ng/L        | ng/L        | ng/L        | ng/L          | ng/L         | ng/L         | ng/L            | ng/L     | ng/L     | ng/L     | ng/L        | ng/L          | ng/L          | ng/L            | ng/L        | ng/L      | ng/L        | ng/L        | ng/L          | ng/L        | ng/L            | ng/L          | ng/L        | ng/L            | ng/L        | ng/L        | ng/L            | ng/L          | ng/L      |          |           |
| NDMA                        | NS          | NS          | NS          | NS            | <b>22000</b> | <b>17000</b> | NS              | NS       | NS       | NS       | NS          | NS            | <b>16000</b>  | <b>30000*</b>   | NS          | NS        | NS          | NS          | <b>14000*</b> | <b>8200</b> | <b>7900</b>     | <b>5200</b>   | <b>15</b>   | <b>190</b>      | <b>16</b>   | <b>180</b>  | <b>370</b>      |               |           |          |           |
| REDUCED GASES (GC)          | µg/L        | µg/L        | µg/L        | µg/L          | µg/L         | µg/L         | µg/L            | µg/L     | µg/L     | µg/L     | µg/L        | µg/L          | µg/L          | µg/L            | µg/L        | µg/L      | µg/L        | µg/L        | µg/L          | µg/L        | µg/L            | µg/L          | µg/L        | µg/L            | µg/L        | µg/L        | µg/L            | µg/L          | µg/L      |          |           |
| Methane                     | NS          | NS          | NS          | NS            | <b>212</b>   | <b>145</b>   | NS              | NS       | NS       | NS       | 2.0 U       | <b>0.98 J</b> | <b>0.96 J</b> | <b>0.82 J</b>   | 2.0 U       | NS        | 2.0 U       | 2.0 U       | 2.0 U         | 2.0 U       | 2.0 U           | 2.0 U         | 2.0 U       | 2.0 U           | 0.87 J      | 2.0 U       | 2.0 U           | 1.47 J        |           |          |           |
| Ethane                      | NS          | NS          | NS          | NS            | 4.0 U        | 4.0 U        | NS              | NS       | NS       | NS       | 4.0 U       | 4.0 U         | 4.0 U         | 4.0 U           | 4.0 U       | NS        | NS          | 4.0 U       | 4.0 U         | 4.0 U       | 4.0 U           | 4.0 U         | 4.0 U       | 4.0 U           | 4.0 U       | 4.0 U       | 4.0 U           | 4.0 U         | 4.0 U     |          |           |
| Ethene                      | NS          | NS          | NS          | NS            | 5.0 U        | 5.0 U        | NS              | NS       | NS       | NS       | 5.0 U       | 5.0 U         | 5.0 U         | 5.0 U           | 5.0 U       | NS        | NS          | 5.0 U       | 5.0 U         | 5.0 U       | 5.0 U           | 5.0 U         | 5.0 U       | 5.0 U           | 5.0 U       | 5.0 U       | 5.0 U           | 5.0 U         | 5.0 U     |          |           |
| Propane                     | NS          | NS          | NS          | NS            | 6.0 U        | 6.0 U        | NS              | NS       | NS       | NS       | <b>50.3</b> | <b>29.3</b>   | 6.0 U         | <b>4.57 J</b>   | <b>7.26</b> | NS        | <b>15.8</b> | <b>16.0</b> | <b>75.8</b>   | <b>124</b>  | 6.0 U           | <b>55.1</b>   | <b>172</b>  | <b>70.8</b>     | <b>63.6</b> | <b>19.1</b> | <b>11.0</b>     |               |           |          |           |
| ANIONS                      | mg/L        | mg/L        | mg/L        | mg/L          | mg/L         | mg/L         | mg/L            | mg/L     | mg/L     | mg/L     | mg/L        | mg/L          | mg/L          | mg/L            | mg/L        | mg/L      | mg/L        | mg/L        | mg/L          | mg/L        | mg/L            | mg/L          | mg/L        | mg/L            | mg/L        | mg/L        | mg/L            | mg/L          | mg/L      |          |           |
| Chloride                    | <b>11.3</b> | <b>9.39</b> | <b>9.29</b> | <b>9.28</b>   | <b>10.8</b>  | <b>9.46</b>  | NS              | NS       | NS       | NS       | <b>9.76</b> | <b>8.79</b>   | <b>9.29</b>   | <b>8.67</b>     | NS          | NS        | NS          | NS          | <b>8.69</b>   | <b>8.63</b> | <b>8.40</b>     | <b>7.97</b>   | <b>8.47</b> | <b>7.99</b>     | <b>9.00</b> | <b>8.65</b> | <b>8.92</b>     |               |           |          |           |
| Nitrite as N                | 0.4 U       | 1.0 U       | 1.0 U       | 1.0 U         | 0.4 U        | 0.4 U        | NS              | NS       | NS       | NS       | 0.4 U       | 0.2 U         | 0.2 U         | 0.2 U           | NS          | NS        | NS          | NS          | NS            | 0.4 U       | 0.4 U           | 0.4 U         | 0.4 U       | 0.4 U           | 0.2 U       | 0.2 U       | 0.2 U           | 0.2 U         |           |          |           |
| Sulfate as SO <sub>4</sub>  | <b>15.9</b> | <b>15.6</b> | <b>15.4</b> | <b>15.9</b>   | <b>19.8</b>  | <b>17.4</b>  | NS              | NS       | NS       | NS       | <b>18.9</b> | <b>14.8</b>   | <b>16.0</b>   | <b>13.6</b>     | NS          | NS        | NS          | NS          | <b>14.8</b>   | <b>14.6</b> | <b>16.1</b>     | <b>14.4</b>   | <b>12.9</b> | <b>13.5</b>     | <b>15.4</b> | <b>13.6</b> | <b>12.5</b>     |               |           |          |           |
| Bromide                     | 0.4 U       | 1.0 U       | 1.0 U       | 1.0 U         | <b>14.5</b>  | <b>8.79</b>  | NS              | NS       | NS       | NS       | <b>1.71</b> | <b>0.63</b>   | <b>0.92</b>   | <b>0.31</b>     | NS          | NS        | NS          | NS          | NS            | NS          | <b>0.29 J</b>   | <b>0.25 J</b> | 0.4 U       | 0.4 U           | 0.4 U       | 0.4 U       | 0.2 U           | <b>0.82</b>   |           |          |           |
| Nitrate as N                | <b>1.37</b> | <b>1.70</b> | <b>1.82</b> | <b>1.80</b>   | <b>2.49</b>  | <b>2.31</b>  | NS              | NS       | NS       | NS       | <b>2.46</b> | <b>2.55</b>   | <b>2.56</b>   | <b>2.63</b>     | NS          | NS        | NS          | NS          | <b>1.89</b>   | <b>1.50</b> | <b>1.46</b>     | <b>0.84</b>   | 0.4 U       | 0.2 U           | 0.2 U       | 0.2 U       | 0.15 J          | <b>0.15 J</b> |           |          |           |
| O-Phosphate as P            | 0.4 U       | 1.0 U       | 1.0 U       | <b>0.44 J</b> | 0.4 U        | 0.4 U        | NS              | NS       | NS       | NS       | 0.4 U       | 0.2 U         | 0.2 U         | 0.2 U           | NS          | NS        | NS          | NS          | NS            | NS          | 0.4 U           | 0.4 U         | 0.4 U       | 0.4 U           | 0.4 U       | 0.2 U       | 0.2 U           | 0.2 U         |           |          |           |
| FIELD PARAMETERS            |             |             |             |               |              |              |                 |          |          |          |             |               |               |                 |             |           |             |             |               |             |                 |               |             |                 |             |             |                 |               |           |          |           |
| pH (SU)                     | NS          | NS          | NS          | NS            | 6.70         | 7.16         | 7.59            | 6.88     | 7.12     | 5.97     | 7.00        | 6.84          | 7.14          | 6.80            | 6.90        | NS        | 6.72        | 6.84        | 6.67          | 6.60        | 6.93            | 6.68          | 6.80        | 6.70            | 6.90        | 6.43        | 6.28            |               |           |          |           |
| Temperature (°C)            | NS          | NS          | NS          | NS            | 15.33        | 14.28        | 11.70           | 14.94    | 14.97    | 15.36    | 15.21       | 14.70         | NS            | 16.59           | 17.55       | NS        | 17.75       | 17.34       | 18.55         | 20.33       | 18.15           | 18.49         | 15.04       | 14.90           | 14.07       | 14.51       | 14.32           |               |           |          |           |
| Dissolved Oxygen (DO, mg/L) | NS          | NS          | NS          | NS            | 4.35         | 3.20         | 1.24            | 17.35    | 15.19    | 28.92    | 15.38*      | 10.56         | 9*            | 12.91           | 9.43        | 8.66      | 10.85       | 11.77       | 12.65         | 14.03       | 11.70           | 10.21         | 11.53       | 10.65           | 10.61       | 5.11        | 8.84            |               |           |          |           |
| Redox Potential (ORP, mV)   | NS          | NS          | NS          | NS            | -101.0       | -70.9        | 76.8            | 81.4     | 168.7    | 197.8    | 146.8       | 224.7         | 62.8          | 210.4           | 123.3       | NS        | 27.0        | 103.9       | 46.2          | 281.0       | 133.2           | 125.6         | 433.9       | 490.8           | 139.1       | 124.8       | 103.1           |               |           |          |           |
| Conductivity (µS/cm)        | NS          | NS          | NS          | NS            | 355          | 338          | 349             | 693      | 556      | 555      | 289         | 205.9         | 358           | 534             | 233         | NS        | 175         | 208         | 259           | 271         | 256             | 198           | 224         | 190             | 126         | 141         |                 |               |           |          |           |
| Depth to Water (ft-btoc)    | NS          | NS          | NS          | NS            | 8.31         | 6.54         | 7.25            | 6.71     | 7.83     | 4.18     | 8.10        | 7.69          | 7.33          | 7.46            | 8.39        | 6.90      | 9.30        | 10.68       | 10.07         | 7.55        | 10.16           | 10.81         | 10.90       | 9.51            | 11.74       | 8.11        | 7.33            |               |           |          |           |
| Microbiology                | cfu/mL      | cfu/mL      | cfu/mL      | cfu/mL        | cfu/mL       | cfu/mL       | cfu/mL          | cfu/mL   | cfu/mL   | cfu/mL   | cfu/mL      | cfu/mL        | cfu/mL        | cfu/mL          | cfu/mL      | cfu/mL    | cfu/mL      | cfu/mL      | cfu/mL        | cfu/mL      | cfu/mL          | cfu/mL        | cfu/mL      | cfu/mL          | cfu/mL      | cfu/mL      | cfu/mL          | cfu/mL        |           |          |           |
| Propane Monooxygenase       | NS          | NS          | NS          | NS            | NS           | NS           | <b>2.44E+03</b> | NS       | NS       | NS       | NS          | NS            | NS            | <b>5.07E+02</b> | NS          | NS        | NS          | NS          | NS            | NS          | <b>9.80E+05</b> | NS            | NS          | <b>6.36E+05</b> | NS          | NS          | <b>2.93E+05</b> |               |           |          |           |

**BOLD** value indicates the compound was detected above the reporting limit.

U - The compound was not detected at the indicated PQL concentration.

J - The compound is present at a concentration less than the quantitation limit but greater than zero. The reported concentration is an estimate.

NS - Not Sampled

\*Value calculated based on water temperature and atmospheric pressure

^Value had unacceptable surrogate recoveries

°Value obtained using CHEMetrics colorimetric assay

**PMW-5: ANALYTICAL DATA SUMMARY**

ESTCP-Aerojet

| Sample ID                   | PMW-5        | PMW-5        | PMW-5    | PMW-5    | PMW-5    | PMW-5     | PMW-5     | PMW-5        | PMW-5         | PMW-5    | PMW-5     | PMW-5    | PMW-5         | PMW-5        | PMW-5        | PMW-5        | PMW-5        | PMW-5        | PMW-5        | PMW-5       | PMW-5       |
|-----------------------------|--------------|--------------|----------|----------|----------|-----------|-----------|--------------|---------------|----------|-----------|----------|---------------|--------------|--------------|--------------|--------------|--------------|--------------|-------------|-------------|
| Lab Sample No.              | 8549-2       | 8555-8       |          |          |          | 8621-5    | 8643-5    | 8648-2       | 8681-5        | 8703-5   |           | 8749-4   | 8761-5        | 8796-6       | 8821-5       | 8846-05      | 8872-5       | 8887A-5      | 8901-5       | 8919-5      | 8950-5      |
| Sampling Date               | 11/21/2011   | 12/5/2011    | 2/7/2012 | 2/9/2012 | 2/9/2012 | 2/27/2012 | 3/15/2012 | 3/26/2012    | 5/7/2012      | 6/4/2012 | 6/25/2012 | 7/9/2012 | 7/23/2012     | 8/16/2012    | 9/13/2012    | 10/11/2012   | 11/26/2012   | 12/20/2012   | 1/31/2013    | 3/4/2013    | 4/18/2013   |
| Days                        | -84          | -70          | -6       | -4.5     | -4       | 14        | 31        | 42           | 84            | 112      | 133       | 147      | 161           | 185          | 213          | 241          | 287          | 311          | 353          | 385         | 430         |
| Matrix                      | Water        | Water        | Water    | Water    | Water    | Water     | Water     | Water        | Water         | Water    | Water     | Water    | Water         | Water        | Water        | Water        | Water        | Water        | Water        | Water       | Water       |
| NDMA (EPA 521)              | ng/L         | ng/L         | ng/L     | ng/L     | ng/L     | ng/L      | ng/L      | ng/L         | ng/L          | ng/L     | ng/L      | ng/L     | ng/L          | ng/L         | ng/L         | ng/L         | ng/L         | ng/L         | ng/L         | ng/L        | ng/L        |
| NDMA                        | <b>30000</b> | <b>22000</b> | NS       | NS       | NS       | NS        | NS        | <b>23000</b> | <b>36000*</b> | NS       | NS        | NS       | <b>26000*</b> | <b>29000</b> | <b>42000</b> | <b>25000</b> | <b>22000</b> | <b>31000</b> | <b>16000</b> | <b>8600</b> | <b>5400</b> |
| REDUCED GASES (GC)          | µg/L         | µg/L         | µg/L     | µg/L     | µg/L     | µg/L      | µg/L      | µg/L         | µg/L          | µg/L     | µg/L      | µg/L     | µg/L          | µg/L         | µg/L         | µg/L         | µg/L         | µg/L         | µg/L         | µg/L        | µg/L        |
| Methane                     | 1.51 J       | 0.70 J       | NS       | NS       | NS       | 29.3      | 3.57      | 16.4         | 1.00 J        | 2.0 U    | NS        | 2.0 U    | 2.0 U         | 5.35         | 5.99         | 4.58         | 80.1         | 25.3         | 40.3         | 2800        | 10.8        |
| Ethane                      | 4.0 U        | 4.0 U        | NS       | NS       | NS       | 4.0 U     | 4.0 U     | 4.0 U        | 4.0 U         | 4.0 U    | NS        | 4.0 U    | 4.0 U         | 4.0 U        | 4.0 U        | 4.0 U        | 4.0 U        | 4.0 U        | 4.0 U        | 4.0 U       | 4.0 U       |
| Ethene                      | 5.0 U        | 5.0 U        | NS       | NS       | NS       | 5.0 U     | 5.0 U     | 5.0 U        | 5.0 U         | 5.0 U    | NS        | 5.0 U    | 5.0 U         | 5.0 U        | 5.0 U        | 5.0 U        | 5.0 U        | 5.0 U        | 5.0 U        | 5.0 U       | 5.0 U       |
| Propane                     | 6.0 U        | 6.0 U        | NS       | NS       | NS       | 6.0 U     | 6.0 U     | 1.02 J       | 27.4          | 4.82     | NS        | 24.5     | 5.82 J        | 6.0 U        | 6.0 U        | 6.0 U        | 6.0 U        | 6.0 U        | 6.0 U        | 1.55 J      | 4.47 J      |
| ANIONS                      | mg/L         | mg/L         | mg/L     | mg/L     | mg/L     | mg/L      | mg/L      | mg/L         | mg/L          | mg/L     | mg/L      | mg/L     | mg/L          | mg/L         | mg/L         | mg/L         | mg/L         | mg/L         | mg/L         | mg/L        | mg/L        |
| Chloride                    | 12.0         | 9.25         | NS       | NS       | NS       | 9.69      | 8.86      | 9.22         | 8.98          | NS       | NS        | NS       | 8.86          | 8.93         | 8.85         | 8.83         | 9.16         | 9.20         | 8.67         | 7.98        | 8.42        |
| Nitrite as N                | 0.4 U        | 0.4 U        | NS       | NS       | NS       | 0.4 U     | 0.2 U     | 0.2 U        | 0.2 U         | NS       | NS        | NS       | 0.4 U         | 0.4 U        | 0.4 U        | 0.4 U        | 0.4 U        | 0.2 U        | 0.2 U        | 0.2 U       | 0.2 U       |
| Sulfate as SO <sub>4</sub>  | 15.9         | 14.0         | NS       | NS       | NS       | 14.6      | 13.3      | 13.6         | 14.0          | NS       | NS        | NS       | 14.9          | 15.0         | 14.6         | 14.8         | 14.7         | 13.6         | 19.8         | 14.0        | 15.2        |
| Bromide                     | 0.4 U        | 0.98         | NS       | NS       | NS       | 0.40 J    | 0.23      | 0.22         | 0.18 J        | NS       | NS        | NS       | 0.4 U         | 0.4 U        | 0.4 U        | 0.4 U        | 0.4 U        | 0.2 U        | 0.2 U        | 0.2 U       | 0.2 U       |
| Nitrate as N                | 1.23         | 2.25         | NS       | NS       | NS       | 3.05      | 2.77      | 2.81         | 2.52          | NS       | NS        | NS       | 2.28          | 2.53         | 2.47         | 2.32         | 2.50         | 1.49         | 0.74         | 0.38        | 0.25        |
| O-Phosphate as P            | 0.4 U        | 0.4 U        | NS       | NS       | NS       | 0.4 U     | 0.2 U     | 0.2 U        | 0.2 U         | NS       | NS        | NS       | 0.4 U         | 0.4 U        | 0.4 U        | 0.4 U        | 0.2 U        | 0.2 U        | 0.2 U        | 0.2 U       | 0.2 U       |
| FIELD PARAMETERS            |              |              |          |          |          |           |           |              |               |          |           |          |               |              |              |              |              |              |              |             |             |
| pH (SU)                     | 6.79         | 6.98         | 7.21     | 6.95     | 6.63     | 7.24      | 6.68      | 7.20         | 6.50          | 6.65     | NS        | 6.76     | 6.80          | 6.80         | 6.87         | 6.81         | 6.30         | 6.59         | 6.54         | 6.50        | 6.24        |
| Temperature (°C)            | 16.24        | 14.46        | 14.91    | 15.07    | 16.70    | 16.27     | 16.00     | 13.84        | 16.88         | 17.08    | NS        | 18.04    | 18.34         | 19.96        | 19.13        | 18.74        | 16.10        | 15.47        | 14.76        | 15.36       | 16.11       |
| Dissolved Oxygen (DO; mg/L) | 5.69         | 0.90         | 0.29     | 0.47     | 0.38     | 0.65*     | 0.46      | 0.62         | 7.96          | 4.04     | 1.36      | 10.31    | 9.47          | 14.13        | 10.79        | 7.48         | 13.88        | 12.39        | 9.45         | 10.71       | 14.37       |
| Redox Potential (ORP; mV)   | -14.1        | -33.9        | 67.5     | 109.8    | 85.3     | 274.1     | 172.9     | 43.6         | 207.1         | 104.5    | NS        | 79.3     | 11.7          | 250.2        | 127.4        | 106.2        | 407.9        | 480.9        | 99.1         | 118.6       | 61.3        |
| Conductivity (µS/cm)        | 266          | 256          | 201      | 447      | 776      | 242       | 218       | 291          | 506           | 223      | NS        | 203      | 250           | 265          | 258          | 257          | 214          | 219          | 229          | 191         | 172         |
| Depth to Water (ft-btoc)    | 1.71         | 1.95         | 2.04     | 2.35     | 0        | 2.99      | 3.06      | 2.65         | 2.48          | 3.75     | 2.46      | 4.21     | 4.86          | 3.53         | 3.79         | 4.60         | 5.33         | 4.81         | 4.73         | 2.44        | 2.51        |
| Microbiology                | cfu/mL       | cfu/mL       | cfu/mL   | cfu/mL   | cfu/mL   | cfu/mL    | cfu/mL    | cfu/mL       | cfu/mL        | cfu/mL   | cfu/mL    | cfu/mL   | cfu/mL        | cfu/mL       | cfu/mL       | cfu/mL       | cfu/mL       | cfu/mL       | cfu/mL       | cfu/mL      | cfu/mL      |
| Propane Monooxygenase       | NS           | NS           | 7.94E+04 | NS       | NS       | NS        | NS        | NS           | 7.04E+04      | NS       | NS        | NS       | NS            | NS           | NS           | 9.34E+04     | NS           | NS           | 6.51E+02     | NS          | 6.40E+04    |

BOLD value indicates the compound was detected above the reporting limit.  
 U - The compound was not detected at the indicated PQL concentration.  
 J - The compound is present at a concentration less than the quantitation limit but greater than zero. The reported concentration is an estimate.  
 NS - Not Sampled  
 \*Value calculated based on water temperature and atmospheric pressure  
 ^Value had unacceptable surrogate recoveries



**PMW-6: ANALYTICAL DATA SUMMARY**

ESTCP-Aerojet

| Sample ID                   | PMW-6         | PMW-6         | PMW-6        | PMW-6        | PMW-6        | PMW-6        | PMW-6        | PMW-6       | PMW-6        | PMW-6        | PMW-6        | PMW-6        | PMW-6        | PMW-6        | PMW-6        | PMW-6        | PMW-6        | PMW-6        |             |             |             |     |     |   |
|-----------------------------|---------------|---------------|--------------|--------------|--------------|--------------|--------------|-------------|--------------|--------------|--------------|--------------|--------------|--------------|--------------|--------------|--------------|--------------|-------------|-------------|-------------|-----|-----|---|
| Lab Sample No.              | 8549-3        | 8555-9        |              |              | 8621-6       | 8648-1       | 8681-6       |             | 8749-5       | 8761-6       | 8796-7       | 8821-6       | 8846-6       | 8872-6       | 8887A-6      | 8901-6       | 8919-6       | 8950-6       |             |             |             |     |     |   |
| Sampling Date               | 11/21/2011    | 12/5/2011     | 2/9/2012     | 2/9/2012     | 2/27/2012    | 3/26/2012    | 5/7/2012     | 6/25/2012   | 7/9/2012     | 7/23/2012    | 8/16/2012    | 9/13/2012    | 10/11/2012   | 11/26/2012   | 12/20/2012   | 1/31/2013    | 3/4/2013     | 4/18/2013    |             |             |             |     |     |   |
| Days                        | -84           | -70           | -4.5         | -4           | 14           | 42           | 84           | 133         | 147          | 161          | 185          | 213          | 241          | 287          | 311          | 353          | 385          | 430          |             |             |             |     |     |   |
| Matrix                      | Water         | Water         | Water        | Water        | Water        | Water        | Water        | Water       | Water        | Water        | Water        | Water        | Water        | Water        | Water        | Water        | Water        | Water        |             |             |             |     |     |   |
| NDMA (EPA 521)              | ng/L          | ng/L          | ng/L         | ng/L         | ng/L         | ng/L         | ng/L         | ng/L        | ng/L         | ng/L         | ng/L         | ng/L         | ng/L         | ng/L         | ng/L         | ng/L         | ng/L         | ng/L         |             |             |             |     |     |   |
| NDMA                        | <b>23000</b>  | <b>22000</b>  | NS           | NS           | NS           | <b>20000</b> | <b>19000</b> | NS          | NS           | <b>24000</b> | <b>28000</b> | <b>33000</b> | <b>24000</b> | <b>25000</b> | <b>26000</b> | <b>26000</b> | <b>16000</b> | <b>13000</b> |             |             |             |     |     |   |
| REDUCED GASES (GC)          | µg/L          | µg/L          | µg/L         | µg/L         | µg/L         | µg/L         | µg/L         | µg/L        | µg/L         | µg/L         | µg/L         | µg/L         | µg/L         | µg/L         | µg/L         | µg/L         | µg/L         | µg/L         |             |             |             |     |     |   |
| Methane                     | <b>3.47</b>   | <b>1.30</b>   | NS           | NS           | <b>26.4</b>  | <b>16.4</b>  | <b>5.50</b>  | NS          | U            | 2.0          | U            | 2.0          | U            | 2.0          | U            | <b>0.96</b>  | J            | 2.0          | U           | 2.0         | U           | 2.0 | U   |   |
| Ethane                      | <b>0.87</b>   | J             | 4.0          | U            | NS           | NS           | 4.0          | U           | 4.0          | U            | 4.0          | U            | 4.0          | U            | 4.0          | U            | 4.0          | U            | 4.0         | U           | 4.0         | U   | 4.0 | U |
| Ethene                      | <b>0.79</b>   | J             | 5.0          | U            | NS           | NS           | 5.0          | U           | 5.0          | U            | 5.0          | U            | 5.0          | U            | 5.0          | U            | 5.0          | U            | 5.0         | U           | 5.0         | U   | 5.0 | U |
| Propane                     | 6.0           | U             | 6.0          | U            | NS           | NS           | 6.0          | U           | <b>3.31</b>  | J            | <b>1.05</b>  | J            | NS           | U            | 6.0          | U            | 6.0          | U            | 6.0         | U           | 6.0         | U   | 6.0 | U |
| ANIONS                      | mg/L          | mg/L          | mg/L         | mg/L         | mg/L         | mg/L         | mg/L         | mg/L        | mg/L         | mg/L         | mg/L         | mg/L         | mg/L         | mg/L         | mg/L         | mg/L         | mg/L         | mg/L         |             |             |             |     |     |   |
| Chloride                    | <b>13.2</b>   | <b>8.40</b>   | NS           | NS           | <b>8.48</b>  | <b>9.12</b>  | <b>9.36</b>  | NS          | NS           | <b>9.49</b>  | <b>9.41</b>  | <b>9.30</b>  | <b>9.78</b>  | <b>9.59</b>  | <b>8.81</b>  | <b>9.33</b>  | <b>9.06</b>  | <b>9.54</b>  |             |             |             |     |     |   |
| Nitrite as N                | 0.4           | U             | 0.4          | U            | NS           | NS           | 0.4          | U           | 0.2          | U            | 0.2          | U            | NS           | NS           | 0.4          | U            | 0.4          | U            | 0.4         | U           | 0.4         | U   | 0.2 | U |
| Sulfate as SO <sub>4</sub>  | <b>13.2</b>   | <b>12.1</b>   | NS           | NS           | <b>12.8</b>  | <b>11.6</b>  | <b>10.5</b>  | NS          | NS           | <b>16.1</b>  | <b>16.7</b>  | <b>16.6</b>  | <b>16.6</b>  | <b>15.7</b>  | <b>15.0</b>  | <b>16.5</b>  | <b>15.6</b>  | <b>15.3</b>  |             |             |             |     |     |   |
| Bromide                     | 0.4           | U             | 0.4          | U            | NS           | NS           | <b>0.39</b>  | J           | <b>16.4</b>  | <b>40.7</b>  | NS           | NS           | <b>10.0</b>  | <b>4.84</b>  | <b>2.62</b>  | <b>1.22</b>  | <b>0.87</b>  | <b>1.61</b>  | <b>1.19</b> | <b>2.10</b> | <b>3.19</b> |     |     |   |
| Nitrate as N                | 0.4           | U             | <b>1.08</b>  | NS           | NS           | <b>1.36</b>  | <b>1.91</b>  | <b>2.36</b> | NS           | NS           | <b>2.68</b>  | <b>2.48</b>  | <b>2.41</b>  | <b>2.43</b>  | <b>2.31</b>  | <b>1.90</b>  | <b>1.38</b>  | <b>1.25</b>  | <b>1.79</b> |             |             |     |     |   |
| O-Phosphate as P            | 0.4           | U             | 0.4          | U            | NS           | NS           | 0.4          | U           | 0.2          | U            | 0.2          | U            | NS           | NS           | 0.4          | U            | 0.4          | U            | 0.4         | U           | 0.2         | U   | 0.2 | U |
| FIELD PARAMETERS            |               |               |              |              |              |              |              |             |              |              |              |              |              |              |              |              |              |              |             |             |             |     |     |   |
| pH (SU)                     | <b>6.96</b>   | <b>6.92</b>   | <b>6.73</b>  | <b>6.57</b>  | <b>6.89</b>  | <b>6.93</b>  | <b>6.52</b>  | NS          | <b>6.58</b>  | <b>6.74</b>  | <b>6.75</b>  | <b>6.77</b>  | <b>6.69</b>  | <b>6.50</b>  | <b>6.57</b>  | <b>6.61</b>  | <b>6.37</b>  | <b>6.23</b>  |             |             |             |     |     |   |
| Temperature (°C)            | <b>16.60</b>  | <b>15.08</b>  | <b>15.91</b> | <b>16.56</b> | <b>15.46</b> | <b>13.79</b> | <b>17.80</b> | NS          | <b>18.33</b> | <b>18.18</b> | <b>19.45</b> | <b>18.86</b> | <b>18.56</b> | <b>16.41</b> | <b>15.45</b> | <b>16.22</b> | <b>15.23</b> | <b>15.96</b> |             |             |             |     |     |   |
| Dissolved Oxygen (DO; mg/L) | <b>3.25</b>   | <b>0.43</b>   | <b>0.29</b>  | <b>0.56</b>  | <b>0.94*</b> | <b>1.06</b>  | <b>3.21</b>  | <b>2.79</b> | <b>3.03</b>  | <b>3.73</b>  | <b>2.96</b>  | <b>3.68</b>  | <b>2.28</b>  | <b>2.73</b>  | <b>6.51</b>  | <b>8.81</b>  | <b>9.26</b>  | <b>9.32</b>  |             |             |             |     |     |   |
| Redox Potential (ORP; mV)   | <b>-104.9</b> | <b>-118.5</b> | <b>71.4</b>  | <b>71.6</b>  | <b>169.7</b> | <b>60.9</b>  | <b>193.1</b> | NS          | <b>45.4</b>  | <b>-62.4</b> | <b>233.7</b> | <b>88.2</b>  | <b>115.4</b> | <b>399.6</b> | <b>495.4</b> | <b>113.4</b> | <b>119.6</b> | <b>92.1</b>  |             |             |             |     |     |   |
| Conductivity (µS/cm)        | <b>301</b>    | <b>271</b>    | <b>757</b>   | <b>745</b>   | <b>242</b>   | <b>317</b>   | <b>605</b>   | NS          | <b>226</b>   | <b>271</b>   | <b>277</b>   | <b>273</b>   | <b>264</b>   | <b>231</b>   | <b>244</b>   | <b>233</b>   | <b>199</b>   | <b>221</b>   |             |             |             |     |     |   |
| Depth to Water (ft-btoc)    | <b>1.52</b>   | <b>1.83</b>   | <b>2.64</b>  | <b>0</b>     | <b>2.65</b>  | <b>2.55</b>  | <b>2.18</b>  | <b>2.22</b> | <b>3.43</b>  | <b>3.93</b>  | <b>3.56</b>  | <b>3.60</b>  | <b>3.79</b>  | <b>4.37</b>  | <b>4.07</b>  | <b>4.40</b>  | <b>2.13</b>  | <b>2.28</b>  |             |             |             |     |     |   |
| Microbiology                | cfu/mL        | cfu/mL        | cfu/mL       | cfu/mL       | cfu/mL       | cfu/mL       | cfu/mL       | cfu/mL      | cfu/mL       | cfu/mL       | cfu/mL       | cfu/mL       | cfu/mL       | cfu/mL       | cfu/mL       | cfu/mL       | cfu/mL       | cfu/mL       |             |             |             |     |     |   |
| Propane Monoxygenase        | NS            | NS            | NS           | NS           | NS           | NS           | NS           | NS          | NS           | NS           | NS           | NS           | NS           | NS           | NS           | NS           | NS           | NS           |             |             |             |     |     |   |

**BOLD** value indicates the compound was detected above the reporting limit.

U - The compound was not detected at the indicated PQL concentration.

J - The compound is present at a concentration less than the quantitation limit but greater than zero. The reported concentration is an estimate.

NS - Not Sampled

\*Value calculated based on water temperature and atmospheric pressure

**BSW-1: ANALYTICAL DATA SUMMARY**

ESTCP-Aerojet

| Sample ID                   | BSW-1       | BSW-1       | BSW-1       | BSW-1       | BSW-1       | BSW-1       |
|-----------------------------|-------------|-------------|-------------|-------------|-------------|-------------|
| Lab Sample No.              | 8485-7      | 8489-1      | 8489-6      | 8493-1      | 8498-2      | 8502-1      |
| Sampling Date               | 6/28/2011   | 7/1/2011    | 7/5/2011    | 7/11/2011   | 7/26/2011   | 7/28/2011   |
| Days                        |             |             |             |             |             |             |
| Matrix                      | Water       | Water       | Water       | Water       | Water       | Water       |
| <b>NDMA (EPA 521)</b>       | ng/L        | ng/L        | ng/L        | ng/L        | ng/L        | ng/L        |
| NDMA                        | NS          | NS          | NS          | NS          | NS          | NS          |
| <b>REDUCED GASES (GC)</b>   | µg/L        | µg/L        | µg/L        | µg/L        | µg/L        | µg/L        |
| Methane                     | NS          | NS          | NS          | NS          | NS          | NS          |
| Ethane                      | NS          | NS          | NS          | NS          | NS          | NS          |
| Ethene                      | NS          | NS          | NS          | NS          | NS          | NS          |
| Propane                     | NS          | NS          | NS          | NS          | NS          | NS          |
| <b>ANIONS</b>               | mg/L        | mg/L        | mg/L        | mg/L        | mg/L        | mg/L        |
| Chloride                    | <b>139</b>  | <b>14.2</b> | <b>11.8</b> | <b>9.6</b>  | <b>10.2</b> | <b>9.42</b> |
| Nitrite as N                | 0.4 U       | 1.0 U       | 1.0 U       | 1.0 U       | 0.2 U       | 0.2 U       |
| Sulfate as SO <sub>4</sub>  | <b>14.4</b> | <b>14.2</b> | <b>14.2</b> | <b>14.5</b> | <b>14.3</b> | <b>13.9</b> |
| Bromide                     | <b>0.68</b> | 1.0 U       | 1.0 U       | 1.0 U       | <b>185</b>  | <b>8.95</b> |
| Nitrate as N                | <b>2.44</b> | <b>2.36</b> | <b>2.56</b> | <b>2.80</b> | <b>2.74</b> | <b>2.91</b> |
| O-Phosphate as P            | 0.4 U       | 1.0 U       | 1.0 U       | 1.0 U       | 0.2 U       | 0.2 U       |
| <b>FIELD PARAMETERS</b>     |             |             |             |             |             |             |
| pH (SU)                     | NS          | NS          | NS          | NS          | NS          | NS          |
| Temperature (°C)            | NS          | NS          | NS          | NS          | NS          | NS          |
| Dissolved Oxygen (DO; mg/L) | NS          | NS          | NS          | NS          | NS          | NS          |
| Redox Potential (ORP; mV)   | NS          | NS          | NS          | NS          | NS          | NS          |
| Conductivity (µS/cm)        | NS          | NS          | NS          | NS          | NS          | NS          |
| Depth to Water (ft-btoc)    | NS          | NS          | NS          | NS          | NS          | NS          |
| <b>Microbiology</b>         | cfu/mL      | cfu/mL      | cfu/mL      | cfu/mL      | cfu/mL      | cfu/mL      |
| Propane Monooxygenase       | NS          | NS          | NS          | NS          | NS          | NS          |

**BOLD** value indicates the compound was detected above the reporting limit.

U - The compound was not detected at the indicated PQL concentration.

NS - Not Sampled

## BW-6: ANALYTICAL DATA SUMMARY

ESTCP-Aerojet

| Sample ID                   | BW-6          | BW-6          | BW-6         | BW-6          | BW-6         |
|-----------------------------|---------------|---------------|--------------|---------------|--------------|
| Lab Sample No.              | 8740-1        | 8887A-8       | 8901-8       | 8919-7        | 8950-7       |
| Sampling Date               | 6/25/2012     | 12/20/2012    | 1/31/2013    | 3/4/2013      | 4/18/2013    |
| Days                        | 133           | 311           | 353          | 385           | 430          |
| Matrix                      | Water         | Water         | Water        | Water         | Water        |
| <b>NDMA (EPA 521)</b>       | ng/L          | ng/L          | ng/L         | ng/L          | ng/L         |
| NDMA                        | <b>25000</b>  | <b>89</b>     | <b>5</b>     | <b>14</b>     | <b>340</b>   |
| <b>REDUCED GASES (GC)</b>   | µg/L          | µg/L          | µg/L         | µg/L          | µg/L         |
| Methane                     | <b>5.15</b>   | <b>0.91</b> J | 2.0 U        | 2.0 U         | 2.0 U        |
| Ethane                      | <b>1.84</b> J | <b>2.34</b> J | 4.0 U        | 4.0 U         | 4.0 U        |
| Ethene                      | <b>1.68</b> J | 5.0 U         | 5.0 U        | 5.0 U         | 5.0 U        |
| Propane                     | <b>37.2</b>   | <b>793</b>    | <b>221</b>   | 6.0 U         | 6.0 U        |
| <b>ANIONS</b>               | mg/L          | mg/L          | mg/L         | mg/L          | mg/L         |
| Chloride                    | NS            | <b>8.35</b>   | <b>9.55</b>  | <b>8.56</b>   | <b>8.77</b>  |
| Nitrite as N                | NS            | 0.2 U         | 0.2 U        | 0.2 U         | 0.2 U        |
| Sulfate as SO <sub>4</sub>  | NS            | <b>11.5</b>   | <b>12.6</b>  | <b>11.8</b>   | <b>11.5</b>  |
| Bromide                     | NS            | 0.2 U         | 0.2 U        | 0.2 U         | 0.2 U        |
| Nitrate as N                | NS            | 0.2 U         | 0.2 U        | <b>0.15</b> J | <b>0.59</b>  |
| O-Phosphate as P            | NS            | 0.2 U         | 0.2 U        | 0.2 U         | 0.2 U        |
| <b>FIELD PARAMETERS</b>     |               |               |              |               |              |
| pH (SU)                     | NS            | <b>7.20</b>   | <b>7.10</b>  | <b>6.55</b>   | <b>6.46</b>  |
| Temperature (°C)            | NS            | <b>14.67</b>  | <b>15.47</b> | <b>14.52</b>  | <b>15.32</b> |
| Dissolved Oxygen (DO; mg/L) | <b>0.19</b>   | <b>11.10</b>  | <b>10.84</b> | <b>7.11</b>   | <b>2.38</b>  |
| Redox Potential (ORP; mV)   | NS            | <b>503.1</b>  | <b>121.7</b> | <b>125.7</b>  | <b>123.1</b> |
| Conductivity (µS/cm)        | NS            | <b>192</b>    | <b>184</b>   | <b>200</b>    | <b>217</b>   |
| Depth to Water (ft-btoc)    | <b>7.49</b>   | <b>10.54</b>  | <b>12.19</b> | <b>8.49</b>   | <b>9.39</b>  |
| <b>Microbiology</b>         | cfu/mL        | cfu/mL        | cfu/mL       | cfu/mL        | cfu/mL       |
| Propane Monooxygenase       | NS            | NS            | NS           | NS            | NS           |

**BOLD** value indicates the compound was detected above the reporting limit.

U - The compound was not detected at the indicated PQL concentration.

J - The compound is present at a concentration less than the quantitation limit but greater than zero. The reported concentration is an estimate.

NS - Not Sampled

## BW-7: ANALYTICAL DATA SUMMARY

ESTCP-Aerojet

| Sample ID                   | BW-7          | BW-7          | BW-7         | BW-7         | BW-7          |
|-----------------------------|---------------|---------------|--------------|--------------|---------------|
| Lab Sample No.              | 8740-2        | 8887A-9       | 8901-9       | 8919-8       | 8950-8        |
| Sampling Date               | 6/25/2012     | 12/20/2012    | 1/31/2013    | 3/4/2013     | 4/18/2013     |
| Days                        | 133           | 311           | 353          | 385          | 430           |
| Matrix                      | Water         | Water         | Water        | Water        | Water         |
| <b>NDMA (EPA 521)</b>       | ng/L          | ng/L          | ng/L         | ng/L         | ng/L          |
| NDMA                        | <b>15000</b>  | <b>2200</b>   | <b>3800</b>  | <b>26</b>    | <b>9.5</b>    |
| <b>REDUCED GASES (GC)</b>   | µg/L          | µg/L          | µg/L         | µg/L         | µg/L          |
| Methane                     | <b>3.04</b>   | <b>1.43</b> J | 2.0 U        | <b>2.50</b>  | <b>98.4</b>   |
| Ethane                      | <b>0.65</b> J | 4.0 U         | 4.0 U        | 4.0 U        | 4.0 U         |
| Ethene                      | <b>0.97</b> J | 5.0 U         | 5.0 U        | 5.0 U        | 5.0 U         |
| Propane                     | <b>3.72</b> J | 6.0 U         | <b>37.1</b>  | 6.0 U        | <b>1.60</b> J |
| <b>ANIONS</b>               | mg/L          | mg/L          | mg/L         | mg/L         | mg/L          |
| Chloride                    | NS            | <b>8.26</b>   | <b>8.92</b>  | <b>8.47</b>  | <b>8.90</b>   |
| Nitrite as N                | NS            | 0.2 U         | 0.2 U        | 0.2 U        | 0.2 U         |
| Sulfate as SO <sub>4</sub>  | NS            | <b>11.8</b>   | <b>13.0</b>  | <b>6.80</b>  | <b>0.52</b>   |
| Bromide                     | NS            | 0.2 U         | 0.2 U        | 0.2 U        | 0.2 U         |
| Nitrate as N                | NS            | <b>1.11</b>   | <b>1.35</b>  | 0.2 U        | 0.2 U         |
| O-Phosphate as P            | NS            | 0.2 U         | 0.2 U        | 0.2 U        | 0.2 U         |
| <b>FIELD PARAMETERS</b>     |               |               |              |              |               |
| pH (SU)                     | NS            | <b>6.69</b>   | <b>6.67</b>  | <b>6.45</b>  | <b>6.11</b>   |
| Temperature (°C)            | NS            | <b>15.11</b>  | <b>15.68</b> | <b>14.56</b> | <b>15.56</b>  |
| Dissolved Oxygen (DO; mg/L) | NS            | <b>9.01</b>   | <b>7.59</b>  | <b>0.43</b>  | <b>0.38</b>   |
| Redox Potential (ORP; mV)   | NS            | <b>514.9</b>  | <b>119.8</b> | <b>102.8</b> | <b>-161.8</b> |
| Conductivity (µS/cm)        | NS            | <b>229</b>    | <b>225</b>   | <b>322</b>   | <b>362</b>    |
| Depth to Water (ft-btoc)    | NS            | <b>9.91</b>   | <b>9.94</b>  | <b>6.87</b>  | <b>6.61</b>   |
| <b>Microbiology</b>         | cfu/mL        | cfu/mL        | cfu/mL       | cfu/mL       | cfu/mL        |
| Propane Monooxygenase       | NS            | NS            | NS           | NS           | NS            |

**BOLD** value indicates the compound was detected above the reporting limit.

U - The compound was not detected at the indicated PQL concentration.

J - The compound is present at a concentration less than the quantitation limit but greater than zero. The reported concentration is an estimate.

NS - Not Sampled

**BMW-1: ANALYTICAL DATA SUMMARY**

ESTCP-Aerojet

| Sample ID                   | BMW-1         | BMW-1         | BMW-1           | BMW-1        | BMW-1                    | BMW-1       | BMW-1         | BMW-1        | BMW-1           | BMW-1        | BMW-1        | BMW-1           | BMW-1        | BMW-1        | BMW-1           |
|-----------------------------|---------------|---------------|-----------------|--------------|--------------------------|-------------|---------------|--------------|-----------------|--------------|--------------|-----------------|--------------|--------------|-----------------|
| Lab Sample No.              | 8549-1        | 8555-1        |                 | 8648-3       | 8681-1                   |             | 8761-7        | 8796-1       | 8821-7          | 8846-7       | 8872-7       | 8887A-7         | 8901-7       | 8919-9       | 8950-9          |
| Sampling Date               | 11/21/2011    | 12/5/2011     | 2/7/2012        | 3/26/2012    | 5/7/2012                 | 6/25/2012   | 7/23/2012     | 8/16/2012    | 9/13/2012       | 10/11/2012   | 11/26/2012   | 12/20/2012      | 1/31/2013    | 3/4/2013     | 4/18/2013       |
| Days                        | -84           | -70           | -6              | 42           | 84                       | 133         | 161           | 185          | 213             | 241          | 287          | 311             | 353          | 385          | 430             |
| Matrix                      | Water         | Water         | Water           | Water        | Water                    | Water       | Water         | Water        | Water           | Water        | Water        | Water           | Water        | Water        | Water           |
| <b>NDMA (EPA 521)</b>       | ng/L          | ng/L          | ng/L            | ng/L         | ng/L                     | ng/L        | ng/L          | ng/L         | ng/L            | ng/L         | ng/L         | ng/L            | ng/L         | ng/L         | ng/L            |
| NDMA                        | <b>35000</b>  | <b>37000</b>  | NS              | <b>26000</b> | <b>35000<sup>a</sup></b> | NS          | <b>31000</b>  | <b>32000</b> | <b>33000</b>    | <b>32000</b> | <b>29000</b> | <b>39000</b>    | <b>31000</b> | <b>25000</b> | <b>27000</b>    |
| <b>REDUCED GASES (GC)</b>   | µg/L          | µg/L          | µg/L            | µg/L         | µg/L                     | µg/L        | µg/L          | µg/L         | µg/L            | µg/L         | µg/L         | µg/L            | µg/L         | µg/L         | µg/L            |
| Methane                     | <b>0.94</b> J | <b>0.68</b> J | NS              | <b>6.14</b>  | <b>3.36</b>              | NS          | 2.0 U         | 2.0 U        | 2.0 U           | <b>2.30</b>  | 2.0 U        | <b>0.79</b> J   | 2.0 U        | 2.0 U        | 2.0 U           |
| Ethane                      | 4.0 U         | 4.0 U         | NS              | 4.0 U        | 4.0 U                    | NS          | 4.0 U         | 4.0 U        | 4.0 U           | 4.0 U        | 4.0 U        | 4.0 U           | 4.0 U        | 4.0 U        | 4.0 U           |
| Ethene                      | 5.0 U         | 5.0 U         | NS              | 5.0 U        | 5.0 U                    | NS          | 5.0 U         | 5.0 U        | 5.0 U           | 5.0 U        | 5.0 U        | 5.0 U           | 5.0 U        | 5.0 U        | 5.0 U           |
| Propane                     | 6.0 U         | 6.0 U         | NS              | 6.0 U        | 6.0 U                    | NS          | <b>63.8</b>   | <b>69.6</b>  | <b>61.3</b>     | <b>10.0</b>  | 6.0 U        | 6.0 U           | 6.0 U        | 6.0 U        | 6.0 U           |
| <b>ANIONS</b>               | mg/L          | mg/L          | mg/L            | mg/L         | mg/L                     | mg/L        | mg/L          | mg/L         | mg/L            | mg/L         | mg/L         | mg/L            | mg/L         | mg/L         | mg/L            |
| Chloride                    | <b>9.94</b>   | <b>8.64</b>   | NS              | <b>8.77</b>  | <b>8.41</b>              | NS          | <b>8.87</b>   | <b>8.72</b>  | <b>8.82</b>     | <b>8.94</b>  | <b>9.29</b>  | <b>8.61</b>     | <b>9.24</b>  | <b>8.69</b>  | <b>9.28</b>     |
| Nitrite as N                | 0.4 U         | 0.4 U         | NS              | 0.2 U        | 0.2 U                    | NS          | 0.4 U         | 0.4 U        | 0.4 U           | 0.4 U        | 0.4 U        | 0.2 U           | 0.2 U        | 0.2 U        | 0.2 U           |
| Sulfate as SO <sub>4</sub>  | <b>15.6</b>   | <b>13.6</b>   | NS              | <b>13.3</b>  | <b>12.9</b>              | NS          | <b>14.4</b>   | <b>14.2</b>  | <b>14.2</b>     | <b>14.2</b>  | <b>13.8</b>  | <b>13.7</b>     | <b>15.2</b>  | <b>14.4</b>  | <b>14.6</b>     |
| Bromide                     | 0.4 U         | 0.4 U         | NS              | 0.2 U        | <b>0.34</b>              | NS          | 0.4 U         | 0.4 U        | 0.4 U           | 0.4 U        | 0.4 U        | 0.2 U           | 0.2 U        | 0.2 U        | 0.2 U           |
| Nitrate as N                | <b>2.56</b>   | <b>2.50</b>   | NS              | <b>2.62</b>  | <b>2.69</b>              | NS          | <b>2.75</b>   | <b>2.70</b>  | <b>2.70</b>     | <b>2.74</b>  | <b>2.90</b>  | <b>2.46</b>     | <b>2.57</b>  | <b>2.06</b>  | <b>2.04</b>     |
| O-Phosphate as P            | 0.4 U         | 0.4 U         | NS              | 0.2 U        | 0.2 U                    | NS          | 0.4 U         | 0.4 U        | 0.4 U           | 0.4 U        | 0.4 U        | 0.2 U           | 0.2 U        | 0.2 U        | 0.2 U           |
| <b>FIELD PARAMETERS</b>     |               |               |                 |              |                          |             |               |              |                 |              |              |                 |              |              |                 |
| pH (SU)                     | <b>6.22</b>   | <b>6.71</b>   | <b>7.17</b>     | <b>6.81</b>  | <b>6.43</b>              | NS          | <b>6.70</b>   | <b>6.64</b>  | <b>6.74</b>     | <b>6.40</b>  | <b>6.37</b>  | <b>6.53</b>     | <b>6.52</b>  | <b>6.06</b>  | <b>5.45</b>     |
| Temperature (°C)            | <b>15.73</b>  | <b>11.71</b>  | <b>11.81</b>    | <b>14.93</b> | <b>16.47</b>             | NS          | <b>17.09</b>  | <b>18.71</b> | <b>17.56</b>    | <b>17.34</b> | <b>15.96</b> | <b>15.36</b>    | <b>15.74</b> | <b>14.26</b> | <b>14.96</b>    |
| Dissolved Oxygen (DO; mg/L) | <b>3.75</b>   | <b>1.61</b>   | <b>2.16</b>     | <b>0.25</b>  | <b>1.03</b>              | <b>1.08</b> | <b>1.56</b>   | <b>2.92</b>  | <b>3.28</b>     | <b>3.78</b>  | <b>5.23</b>  | <b>3.35</b>     | <b>3.21</b>  | <b>2.34</b>  | <b>1.22</b>     |
| Redox Potential (ORP; mV)   | <b>127.4</b>  | <b>101.4</b>  | <b>128.0</b>    | <b>47.2</b>  | <b>187.4</b>             | NS          | <b>-137.8</b> | <b>209.7</b> | <b>70.7</b>     | <b>114.7</b> | <b>391.9</b> | <b>484.1</b>    | <b>117.9</b> | <b>116.1</b> | <b>131.8</b>    |
| Conductivity (µS/cm)        | <b>252</b>    | <b>251</b>    | <b>244</b>      | <b>296</b>   | <b>481</b>               | NS          | <b>239</b>    | <b>249</b>   | <b>248</b>      | <b>246</b>   | <b>211</b>   | <b>219</b>      | <b>224</b>   | <b>180</b>   | <b>200</b>      |
| Depth to Water (ft-btoc)    | <b>3.94</b>   | <b>4.20</b>   | <b>3.17</b>     | <b>4.76</b>  | <b>4.12</b>              | <b>4.51</b> | <b>5.20</b>   | <b>5.05</b>  | <b>5.35</b>     | <b>5.51</b>  | <b>5.52</b>  | <b>5.66</b>     | <b>4.85</b>  | <b>4.06</b>  | <b>4.25</b>     |
| <b>Microbiology</b>         | cfu/mL        | cfu/mL        | cfu/mL          | cfu/mL       | cfu/mL                   | cfu/mL      | cfu/mL        | cfu/mL       | cfu/mL          | cfu/mL       | cfu/mL       | cfu/mL          | cfu/mL       | cfu/mL       | cfu/mL          |
| Propane Monoxygenase        | NS            | NS            | <b>2.33E+04</b> | NS           | <b>1.87E+03</b>          | NS          | NS            | NS           | <b>1.92E+03</b> | NS           | NS           | <b>1.49E+02</b> | NS           | NS           | <b>5.51E+03</b> |

**BOLD** value indicates the compound was detected above the reporting limit.

U - The compound was not detected at the indicated PQL concentration.

J - The compound is present at a concentration less than the quantitation limit but greater than zero. The reported concentration is an estimate.

NS - Not Sampled

<sup>a</sup>Value had unacceptable surrogate recoveries

## **Appendix C: Well Logs and Destruction Reports**



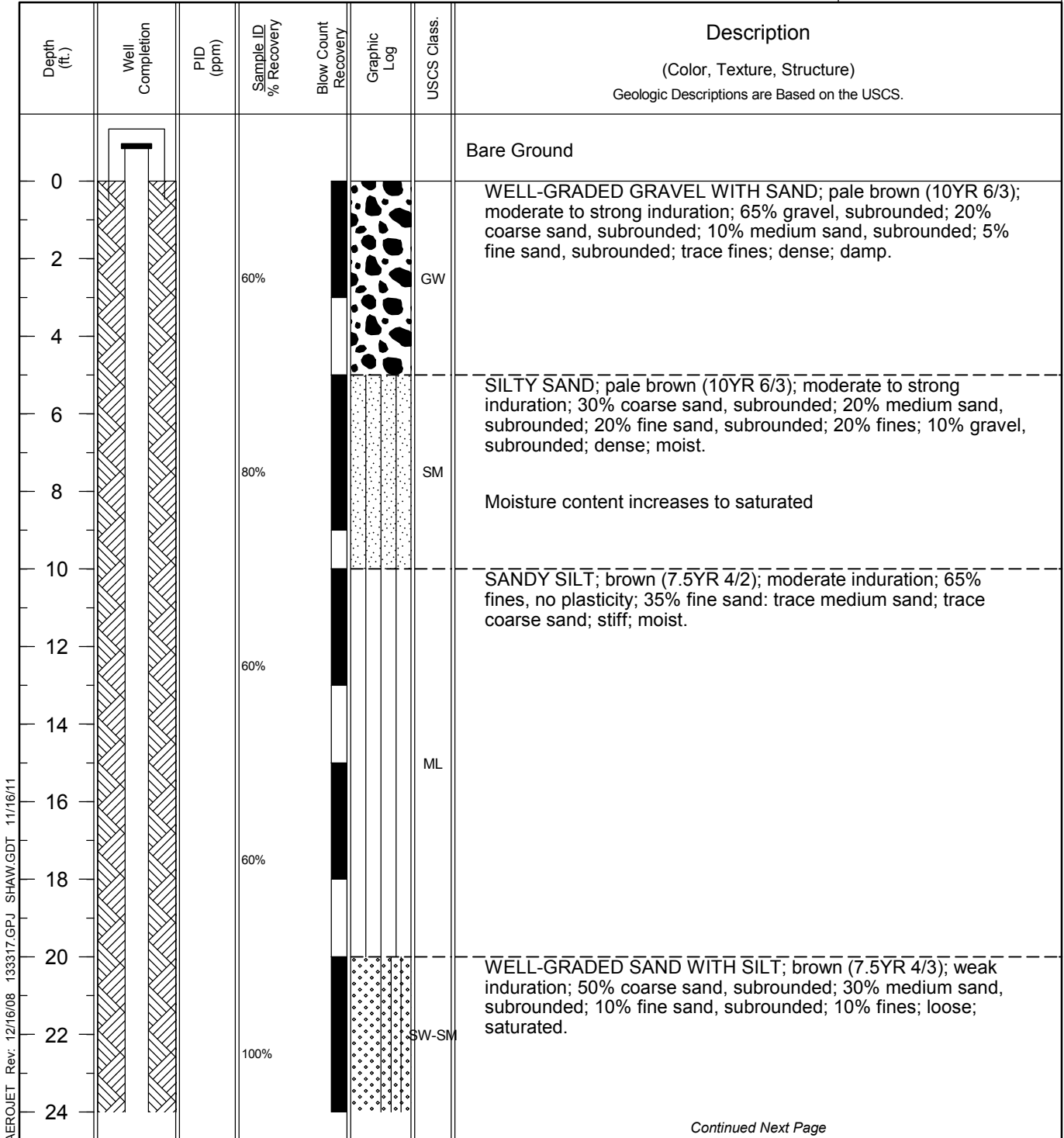
# Drilling Log

Monitoring Well  
**BMW-1**

Page: 1 of 3

Project Aerojet ESTCP-NDMA Demo Owner Aerojet  
 Location Rancho Cordova, CA Proj. No. 133317  
 Surface Elev. NA Total Hole Depth 77 ft. North NA East NA  
 Top of Casing NA Water Level Initial NA Static NA Diameter 6 in.  
 Screen: Dia 2 in. Length 5 ft. Type/Slot Sch 40 PVC/0.010 in.  
 Casing: Dia 2 in. Length 45 ft. Type Sch 40 Blank PVC  
 Fill Material See Comments Rig/Core CRS 17-C/Sonic  
 Drill Co. Cascade Drilling Method Sonic Core  
 Driller Jeff Jones Log By Adam Norvelle Date 10/25/11 Permit # NA  
 Checked By \_\_\_\_\_ License No. \_\_\_\_\_

COMMENTS  
Annular Seal  
Bentonite-Cement Grout 0-40'  
Plug  
Bentonite Chips 40-43'  
Filter Pack  
#2/12 Sand 43-52'  
Screened Interval  
Sch 40 0.010" Machine Slot  
PVC 45-50'  
Bottom Plug  
Bentonite Chips 52-77'



AEROJET Rev: 12/16/08 133317.GPJ SHAW.GDT 11/16/11

Continued Next Page



# Drilling Log

Monitoring Well  
**BMW-1**

Page: 2 of 3

Project Aerojet ESTCP-NDMA Demo

Owner Aerojet

Location Rancho Cordova, CA

Proj. No. 133317

| Depth (ft.) | Well Completion | PID (ppm) | Sample ID % Recovery | Blow Count Recovery | Graphic Log | USCS Class. | Description<br>(Color, Texture, Structure)<br>Geologic Descriptions are Based on the USCS.  |
|-------------|-----------------|-----------|----------------------|---------------------|-------------|-------------|---|
| 24          |                 |           |                      |                     |             |             |   |
| 26          |                 |           |                      |                     |             | SW-SM       |   |
| 28          |                 |           | 100%                 |                     |             |             | WELL-GRADED SAND WITH SILT AND GRAVEL; brown (7.5YR 4/3); weak induration; 40% coarse sand, subrounded; 25% medium sand, subrounded; 10% fine sand, subrounded; 15% gravel, subrounded; 10% fines; medium dense; moist.               |
| 30          |                 |           |                      |                     |             |             | SANDY SILT; light brown (7.5YR 6/3); weak induration; 60% fines, no plasticity; 35% fine sand; 5% medium sand; stiff, moist.  |
| 32          |                 |           | 80%                  |                     |             | ML          | SANDY SILT WITH GRAVEL; brown (7.5 YR 4/3); weak induration; 60% fines, no plasticity; 10% coarse sand; 10% fine sand; 20% gravel to 2 in.; firm; saturated.  |
| 34          |                 |           |                      |                     |             |             |   |
| 36          |                 |           |                      |                     |             |             | SILTY SAND; light brownish gray (10YR 6/2); strong induration; 30% fine sand, subrounded; 20% medium sand, subrounded; 10% coarse sand, subrounded; 40% fines; very dense; saturated.   |
| 38          |                 |           | 80%                  |                     |             |             | Fine sand decreases to 25%, medium sand decreases to 15%, 10% gravel to 1.5 in., density decreases to dense, moisture content decreases to wet  |
| 40          |                 |           |                      |                     |             | SM          |   |
| 42          |                 |           | 80%                  |                     |             |             |   |
| 44          |                 |           |                      |                     |             |             |   |
| 46          |                 |           | 80%                  |                     |             | SW-GM       | WELL-GRADED GRAVEL WITH SILT AND SAND; pale yellowish brown (10YR 6/2); weak induration; 60% gravel to 1.5 in., subrounded; 20% coarse sand, subrounded; 5% medium sand, subrounded; 5% fine sand, subrounded; 10% fines; loose; wet. |
| 48          |                 |           |                      |                     |             |             |   |
| 50          |                 |           |                      |                     |             |             | SANDY SILT; light brown (5YR 5/6); weak induration; 65% fines, no plasticity; 30% fine sand; 5% medium sand; trace coarse sand; trace gravel to 1 in.; firm; wet.   |
| 52          |                 |           | 100%                 |                     |             | ML          |   |
| 54          |                 |           |                      |                     |             |             |   |

AEROJET Rev: 12/16/08 133317.GPJ SHAW.GDT 11/16/11

Continued Next Page





# Drilling Log

Monitoring Well

**BMW-1**

Page: 3 of 3

Project Aerojet ESTCP-NDMA Demo Owner Aerojet

Location Rancho Cordova, CA Proj. No. 133317

| Depth (ft.) | Well Completion | PID (ppm) | Sample ID % Recovery | Blow Count Recovery | Graphic Log | USCS Class. | Description<br>(Color, Texture, Structure)<br>Geologic Descriptions are Based on the USCS.   |  |
|-------------|-----------------|-----------|----------------------|---------------------|-------------|-------------|--|--|
| 56          | [Redacted]      |           |                      | [Redacted]          | [Redacted]  |             |  |  |
| 58          |                 |           | 100%                 |                     |             |             |  |  |
| 60          |                 |           |                      |                     |             |             |  |  |
| 62          |                 |           | 100%                 |                     |             |             |  |  |
| 64          |                 |           |                      |                     |             |             | ML   |  |
| 66          |                 |           |                      |                     |             |             |  |  |
| 68          |                 |           | 100%                 |                     |             |             |  |  |
| 70          |                 |           |                      |                     |             |             |  |  |
| 72          |                 | 100%      |                      |                     |             |             |  |  |
| 74          |                 |           |                      |                     |             |             |  |  |
| 76          |                 | 100%      |                      |                     | [Hatched]   | CL          | LEAN CLAY WITH GRAVEL; olive brown (5Y 4/4); weak induration; 75% fines, low plasticity; 25% gravel to 4 in., weathered blue slate; firm; moist. |  |
| 78          |                 |           |                      |                     |             |             | Boring terminated at 77 feet BGS   |  |
| 80          |                 |           |                      |                     |             |             |  |  |
| 82          |                 |           |                      |                     |             |             |  |  |
| 84          |                 |           |                      |                     |             |             |  |  |

AEROJET Rev: 12/16/08 133317.GPJ SHAW.GDT 11/16/11



# Drilling Log

Sparge Well  
**BW-1**

Page: 1 of 3

Project Aerojet ESTCP-NDMA Demo Owner Aerojet  
 Location Rancho Cordova, CA Proj. No. 133317  
 Surface Elev. NA Total Hole Depth 71 ft. North NA East NA  
 Top of Casing NA Water Level Initial NA Static NA Diameter 6 in.  
 Screen: Dia 2 in. Length 5 ft. Type/Slot Schumasoil 20 Micron  
 Casing: Dia 2 in. Length 57 ft. Type Sch 40 Blank PVC  
 Fill Material See Comments Rig/Core CRS 17-C/Sonic  
 Drill Co. Cascade Drilling Method Sonic Core  
 Driller Jeff Jones Log By Adam Norvelle Date 11/5/11 Permit # NA  
 Checked By \_\_\_\_\_ License No. \_\_\_\_\_

COMMENTS  
Annular Seal  
Bentonite-Cement Grout 0-51'  
Plug  
Bentonite Chips 51-54'  
Filter Pack  
#2/12 Sand 54-63'  
Screened Interval  
Schumasoil 20 Micron 57-62'  
Bottom Plug  
Bentonite Chips 63-71'

| Depth (ft.) | Well Completion | PID (ppm) | Sample ID % Recovery | Blow Count Recovery | Graphic Log | USCS Class. | Description<br>(Color, Texture, Structure)<br>Geologic Descriptions are Based on the USCS.   |
|-------------|-----------------|-----------|----------------------|---------------------|-------------|-------------|--|
| 0           |                 |           |                      |                     |             |             | Bare Ground  |
| 2           |                 |           | 80%                  |                     |             | ML          | GRAVELLY SILT WITH SAND; moderate yellowish brown (10YR 5/4); weak induration; 60% fines, no plasticity; 25% gravel; 10% fine sand; 5% medium sand; firm; dry.   |
| 4           |                 |           |                      |                     |             |             |  |
| 6           |                 |           | 60%                  |                     |             |             |  |
| 8           |                 |           |                      |                     |             |             |  |
| 10          |                 |           |                      |                     |             |             | WELL-GRADED SAND WITH SILT; dark yellowish brown (10YR 4/2); moderate to strong induration; 35% coarse sand, subrounded; 30% medium sand, subrounded; 25% fine sand, subrounded; 10% fines; dense; damp.         |
| 12          |                 |           | 80%                  |                     |             |             |  |
| 14          |                 |           |                      |                     |             | SW-SM       | Moisture content increases to wet<br>Induration decreases to weakly indurated, density decreases to loose  |
| 16          |                 |           | 100%                 |                     |             |             |  |
| 18          |                 |           | 75%                  |                     |             |             |  |
| 20          |                 |           |                      |                     |             |             |  |
| 22          |                 |           | 80%                  |                     |             | SM          | SILTY SAND WITH GRAVEL; moderate yellowish brown (10YR 5/4); 30% fine sand, subrounded; 5% medium sand, subrounded; 5% coarse sand, subrounded; 35% gravel to 3 in., subrounded; 25% fines; medium dense; moist. |
| 24          |                 |           |                      |                     |             |             |  |

AEROJET Rev: 12/16/08 133317.GPJ SHAW.GDT 11/16/11

Continued Next Page



# Drilling Log

Sparge Well  
**BW-1**

Page: 2 of 3

Project Aerojet ESTCP-NDMA Demo Owner Aerojet  
 Location Rancho Cordova, CA Proj. No. 133317

| Depth (ft.) | Well Completion | PID (ppm) | Sample ID % Recovery | Blow Count Recovery | Graphic Log | USCS Class. | Description<br>(Color, Texture, Structure)<br>Geologic Descriptions are Based on the USCS.   |
|-------------|-----------------|-----------|----------------------|---------------------|-------------|-------------|--|
| 24          |                 |           |                      |                     |             |             |  |
| 26          |                 |           |                      |                     |             |             |  |
| 28          |                 |           | 80%                  |                     |             | SM          | SILTY SAND; moderate yellowish brown (10YR 5/4); weak induration; 40% fine sand, subrounded; 15% medium sand, subrounded; 10% coarse sand, subrounded; 35% fines; medium dense; damp.  |
| 30          |                 |           | 100%                 |                     |             |             |  |
| 32          |                 |           |                      |                     |             |             |  |
| 34          |                 |           | 33%                  |                     |             | SW          | WELL-GRADED SAND; dark yellowish brown (10YR 4/2); weak induration; 50% fine sand, subrounded; 30% medium sand, subrounded; 20% coarse sand, subrounded; trace fines; loose; wet.  |
| 36          |                 |           |                      |                     |             |             |  |
| 38          |                 |           | 80%                  |                     |             | ML          | GRAVELLY SILT WITH SAND; moderate yellowish brown (10YR 5/4); weakly indurated; 55% fines, no plasticity; 30% gravel to 2.5 in.; 15% fine sand; firm; moist.   |
| 40          |                 |           |                      |                     |             |             |  |
| 42          |                 |           | 50%                  |                     |             | GW          | WELL-GRADED GRAVEL WITH SAND; moderate yellowish brown (10YR 5/4); weak induration; 65% gravel to 1.5 in., subrounded; 20% coarse sand, subrounded; 10% medium sand, subrounded; 5% fine sand, subrounded; trace fines; medium dense; wet. |
| 44          |                 |           |                      |                     |             |             |  |
| 46          |                 |           | 80%                  |                     |             |             |  |
| 48          |                 |           |                      |                     |             | ML          | GRAVELLY SILT WITH SAND; moderate yellowish brown (10YR 5/4); weak induration; 55% fines, no plasticity; 30% gravel to 1.5 in.; 15% fine sand; trace medium sand; trace coarse sand; firm; moist.<br>Density increase to stiff             |
| 50          |                 |           | 80%                  |                     |             |             |  |
| 52          |                 |           | 100%                 |                     |             |             |  |
| 54          |                 |           | 100%                 |                     |             |             | Dark reddish brown (10R 3/4) mottling  |

AEROJET Rev: 12/16/08 133317.GPJ SHAW.GDT 11/16/11

Continued Next Page



# Drilling Log

Sparge Well

**BW-1**

Page: 3 of 3

Project Aerojet ESTCP-NDMA Demo Owner Aerojet

Location Rancho Cordova, CA Proj. No. 133317

| Depth (ft.) | Well Completion | PID (ppm) | Sample ID % Recovery | Blow Count Recovery | Graphic Log | USCS Class. | Description<br>(Color, Texture, Structure)<br>Geologic Descriptions are Based on the USCS.  |
|-------------|-----------------|-----------|----------------------|---------------------|-------------|-------------|---|
| 56          |                 |           |                      |                     |             | GM          | SILTY GRAVEL WITH SAND; moderate yellowish brown (10YR 5/4); weak induration; 50% gravel to 1.5 in., subrounded; 30% fine sand, subrounded; 20% fines; medium dense; wet. |
| 58          |                 |           | 100%                 |                     |             |             |   |
| 60          |                 |           |                      |                     |             |             |   |
| 62          |                 |           | 100%                 |                     |             |             | Density increases to dense, moisture content decreases to moist   |
| 64          |                 |           |                      |                     |             | SM          |   |
| 66          |                 |           |                      |                     |             |             |   |
| 68          |                 |           | 100%                 |                     |             |             |   |
| 70          |                 |           | 100%                 |                     |             | ML          | GRAVELLY SILT; moderate yellowish brown (10YR 5/4); weak induration; 65% fines, low plasticity; 35% gravel to 2.5 in.; firm; moist.                                       |
| 72          |                 |           |                      |                     |             |             | Boring terminated at 71 feet BGS  |
| 74          |                 |           |                      |                     |             |             |   |
| 76          |                 |           |                      |                     |             |             |   |
| 78          |                 |           |                      |                     |             |             |   |
| 80          |                 |           |                      |                     |             |             |   |
| 82          |                 |           |                      |                     |             |             |   |
| 84          |                 |           |                      |                     |             |             |   |

AEROJET Rev: 12/16/08 133317.GPJ SHAW.GDT 11/16/11



# Drilling Log

Sparge Well  
**BW-2**

Page: 1 of 3

Project Aerojet ESTCP-NDMA Demo Owner Aerojet  
 Location Rancho Cordova, CA Proj. No. 133317  
 Surface Elev. NA Total Hole Depth 75 ft. North NA East NA  
 Top of Casing NA Water Level Initial NA Static NA Diameter 6 in.  
 Screen: Dia 2 in. Length 5 ft. Type/Slot Schumasoil 20 Micron  
 Casing: Dia 2 in. Length 62 ft. Type Sch 40 Blank PVC  
 Fill Material See Comments Rig/Core CRS 17-C/Sonic  
 Drill Co. Cascade Drilling Method Sonic Core  
 Driller Jeff Jones Log By Bryan Stempson Date 11/4/11 Permit # NA  
 Checked By \_\_\_\_\_ License No. \_\_\_\_\_

COMMENTS  
Annular Seal  
Bentonite-Cement Grout 0-56'  
Plug  
Bentonite Chips 56-59'  
Filter Pack  
#2/12 Sand 59-69'  
Screened Interval  
Schumasoil 20 Micron 62-67'  
Bottom Plug  
Bentonite Chips 69-75'

| Depth (ft.) | Well Completion | PID (ppm) | Sample ID % Recovery | Blow Count Recovery | Graphic Log | USCS Class. | Description<br>(Color, Texture, Structure)<br>Geologic Descriptions are Based on the USCS.   |
|-------------|-----------------|-----------|----------------------|---------------------|-------------|-------------|--|
| 0           |                 |           |                      |                     |             |             | Bare Ground  |
| 2           |                 |           | 100%                 |                     |             |             | GRAVELLY SILT WITH SAND; moderate yellowish brown (10YR 5/4); weak induration; 60% fines, no plasticity; 25% gravel; 10% fine sand; 5% medium sand; trace coarse sand; firm; dry.              |
| 4           |                 |           |                      |                     |             |             |  |
| 6           |                 |           |                      |                     |             |             |  |
| 8           |                 |           | 100%                 |                     |             | ML          | SANDY SILT; dark grayish brown (10YR 4/2); weak induration; 60% fines, no plasticity; 20% fine sand; 15% meidum sand; 5% coarse sand; trace gravel; firm; damp.                                |
| 10          |                 |           |                      |                     |             |             |  |
| 12          |                 |           | 100%                 |                     |             |             |  |
| 14          |                 |           | 100%                 |                     |             |             |  |
| 16          |                 |           | 100%                 |                     |             |             | Fines increase to 70%, fine sand decreases to 15%, medium sand decreases to 10%  |
| 18          |                 |           | 100%                 |                     |             |             |  |
| 20          |                 |           |                      |                     |             |             |  |
| 22          |                 |           |                      |                     |             | SW          | WELL-GRADED SAND; very dark brown (10YR 2/2); weak induration; 35% coarse sand, subrounded; 30% medium sand, subrounded; 25% fine sand, subrounded; 10% gravel, subrounded; medium dense; wet. |
| 24          |                 |           |                      |                     |             |             |  |

AEROJET Rev: 12/16/08 133317.GPJ SHAW.GDT 11/16/11

Continued Next Page



# Drilling Log

Sparge Well

**BW-2**

Page: 2 of 3

Project Aerojet ESTCP-NDMA Demo

Owner Aerojet

Location Rancho Cordova, CA

Proj. No. 133317

| Depth (ft.) | Well Completion | PID (ppm) | Sample ID % Recovery | Blow Count Recovery | Graphic Log | USCS Class. | Description<br>(Color, Texture, Structure)<br>Geologic Descriptions are Based on the USCS.  |
|-------------|-----------------|-----------|----------------------|---------------------|-------------|-------------|---|
| 24          |                 |           | 100%                 |                     |             | SW          |   |
| 26          |                 |           |                      |                     |             |             |   |
| 28          |                 |           |                      |                     |             |             | WELL-GRADED SAND WITH SILT; brown (10YR 4/3); weak induration; 30% coarse sand, subrounded; 35% medium sand, subrounded; 25% fine sand, subrounded; 10% fines; trace gravel; medium dense; wet. |
| 30          |                 |           |                      |                     |             |             |   |
| 32          |                 |           |                      |                     |             |             |   |
| 34          |                 |           | 30%                  |                     |             | SW-SM       |   |
| 36          |                 |           |                      |                     |             |             |   |
| 38          |                 |           |                      |                     |             |             |   |
| 40          |                 |           | 100%                 |                     |             |             | GRAVELLY SILT WITH SAND; dark yellowish brown (10YR 4/4); weak induration; 55% fines, low plasticity; 25% gravel; 5% coarse sand; 5% medium sand; 10% fine sand; firm; wet.                     |
| 42          |                 |           | 100%                 |                     |             |             |   |
| 44          |                 |           | 100%                 |                     |             |             |   |
| 46          |                 |           |                      |                     |             |             | SANDY SILT WITH GRAVEL; dark grayish brown (10YR 4/2); weak induration; 55% fines, no plasticity; 5% coarse; 15% medium sand; 10% fine sand; 15% gravel; firm; wet.                             |
| 48          |                 |           | 100%                 |                     |             | ML          |   |
| 50          |                 |           |                      |                     |             |             | GRAVELLY SILT WITH SAND; dark grayish brown (10YR 4/2); weak induration; 55% fines, no plasticity; 25% gravel; 5% coarse sand; 5% medium sand; 10% fine sand; stiff; wet.                       |
| 52          |                 |           | 100%                 |                     |             |             |   |
| 54          |                 |           |                      |                     |             |             |   |

AEROJET Rev: 12/16/08 133317.GPJ SHAW.GDT 11/16/11

Continued Next Page



# Drilling Log

Sparge Well

**BW-2**

Page: 3 of 3

Project Aerojet ESTCP-NDMA Demo Owner Aerojet  
 Location Rancho Cordova, CA Proj. No. 133317

| Depth (ft.) | Well Completion | PID (ppm) | Sample ID % Recovery | Blow Count Recovery | Graphic Log | USCS Class. | Description<br>(Color, Texture, Structure)<br>Geologic Descriptions are Based on the USCS.  |
|-------------|-----------------|-----------|----------------------|---------------------|-------------|-------------|---|
| 56          |                 |           | 100%                 |                     |             | ML          |   |
| 58          |                 |           | 100%                 |                     |             |             | SILT WITH SAND; dark yellowish brown (10YR 4/4); weak induration; 80% fines, low plasticity; 20% fine sand; stiff; moist.   |
| 60          |                 |           |                      |                     |             |             | SILTY SAND; dark yellowish brown (10YR 4/4); weak induration; 60% fine sand, subrounded; 40% fines; medium dense; wet.  |
| 62          |                 |           |                      |                     |             |             |   |
| 64          |                 |           |                      |                     |             |             |   |
| 66          |                 |           | 100%                 |                     |             | SM          | Fine sand decreases to 55%, fines increase to 45%, density increases to dense   |
| 68          |                 |           |                      |                     |             |             |   |
| 70          |                 |           |                      |                     |             |             | Fine sand increases to 70%, fines decrease to 30%, density decreases to medium dense  |
| 72          |                 |           | 100%                 |                     |             |             |   |
| 74          |                 |           |                      |                     |             | ML          | GRAVELLY SILT WITH SAND; dark grayish brown (10YR 4/2); weak induration; 55% fines, no plasticity; 25% gravel; 5% coarse sand; 5% medium sand; 10% fine sand; very stiff; damp. |
| 76          |                 |           |                      |                     |             |             | Boring terminated at 75 feet BGS  |
| 78          |                 |           |                      |                     |             |             |   |
| 80          |                 |           |                      |                     |             |             |   |
| 82          |                 |           |                      |                     |             |             |   |
| 84          |                 |           |                      |                     |             |             |   |

AEROJET Rev: 12/16/08 133317.GPJ SHAW.GDT 11/16/11



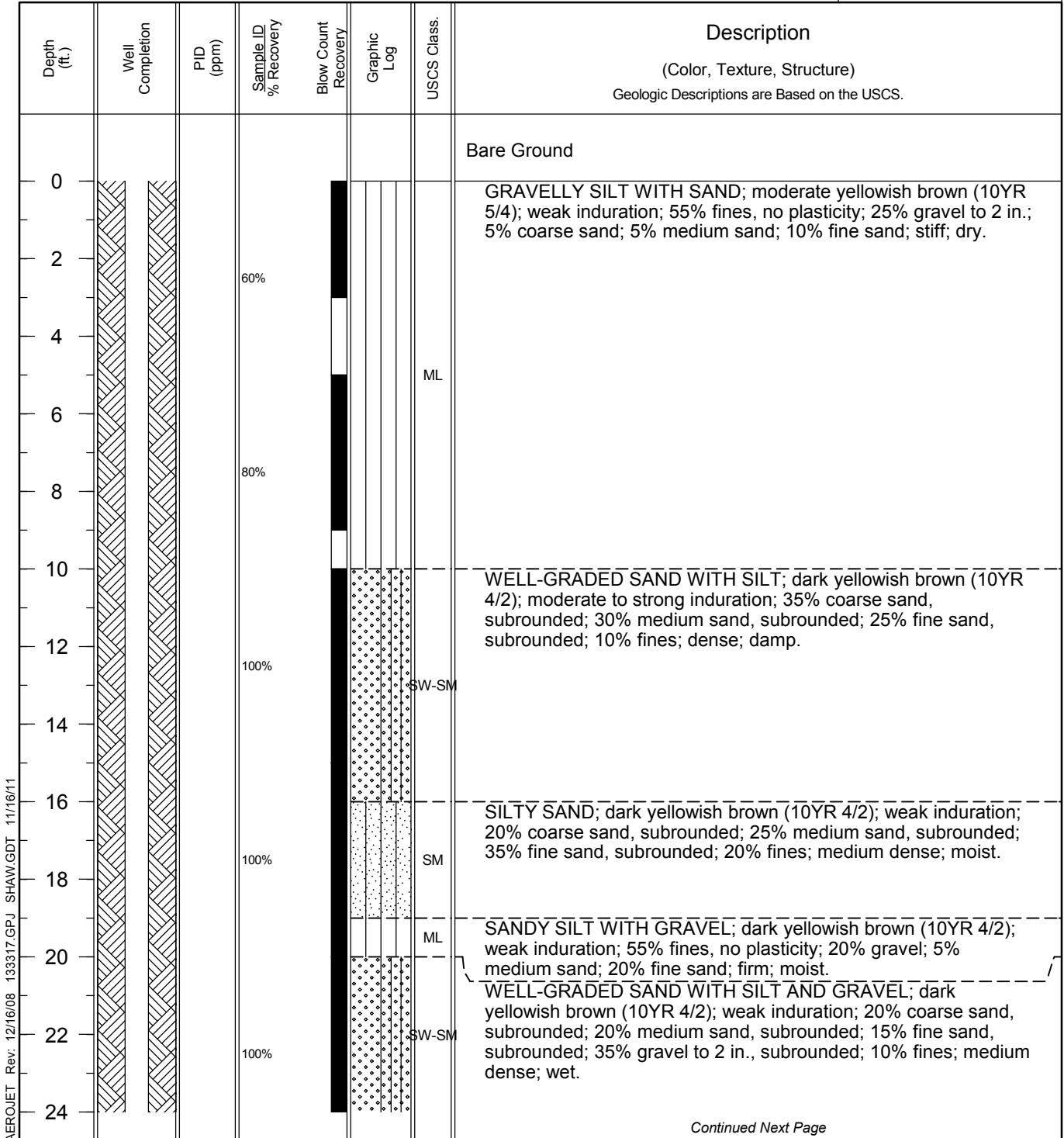
# Drilling Log

Sparge Well  
**BW-4**

Page: 1 of 3

Project Aerojet ESTCP-NDMA Demo Owner Aerojet  
 Location Rancho Cordova, CA Proj. No. 133317  
 Surface Elev. NA Total Hole Depth 77 ft. North NA East NA  
 Top of Casing NA Water Level Initial NA Static NA Diameter 6 in.  
 Screen: Dia 2 in. Length 5 ft. Type/Slot Schumasoil 20 Micron  
 Casing: Dia 2 in. Length 70 ft. Type Sch 40 Blank PVC  
 Fill Material See Comments Rig/Core CRS 17-C/Sonic  
 Drill Co. Cascade Drilling Method Sonic Core  
 Driller Jeff Jones Log By Adam Norvelle Date 11/1/11 Permit # NA  
 Checked By \_\_\_\_\_ License No. \_\_\_\_\_

COMMENTS  
Annular Seal  
Bentonite-Cement Grout 0-64'  
Plug  
Bentonite Chips 64-67'  
Filter Pack  
#2/12 Sand 67-76'  
Screened Interval  
Schumasoil 20 Micron 70-75'  
Bottom Plug  
Slough 76-77'



AEROJET Rev: 12/16/08 133317.GPJ SHAW.GDT 11/16/11

Continued Next Page





# Drilling Log

Sparge Well

**BW-4**

Page: 2 of 3

Project Aerojet ESTCP-NDMA Demo Owner Aerojet

Location Rancho Cordova, CA Proj. No. 133317

| Depth (ft.) | Well Completion | PID (ppm) | Sample ID % Recovery | Blow Count Recovery | Graphic Log | USCS Class. | Description<br>(Color, Texture, Structure)<br>Geologic Descriptions are Based on the USCS.  |
|-------------|-----------------|-----------|----------------------|---------------------|-------------|-------------|---|
| 24          |                 |           |                      |                     |             |             |   |
| 26          |                 |           |                      |                     |             | SW-SM       |   |
| 28          |                 |           | 100%                 |                     |             |             |   |
| 30          |                 |           |                      |                     |             | SM          | SILTY SAND; dark yellowish brown (10YR 4/2); weak induration; 10% coarse sand, subrounded; 15% medium sand, subrounded; 40% fine sand, subrounded; 35% fines; trace gravel; medium dense; wet.                                    |
| 32          |                 |           | 100%                 |                     |             |             |   |
| 34          |                 |           |                      |                     |             | ML          | SANDY SILT; dark yellowish brown (10YR 4/2); weak induration; 60% fines, no plasticity; 5% coarse sand; 5% medium sand; 30% fine sand; trace gravel; firm; moist.<br>Density increases to stiff                                   |
| 36          |                 |           |                      |                     |             |             |   |
| 38          |                 |           | 40%                  |                     |             |             | SILTY SAND WITH GRAVEL; moderate yellowish brown (10YR 5/4); weak induration; 30% coarse sand, subrounded; 15% medium sand, subrounded; 15% fine sand, subrounded; 20% gravel, subrounded; 20% fines; medium dense; wet.          |
| 40          |                 |           |                      |                     |             |             | Coarse sand decreases to 25%, medium sand decreases to 10%, fine sand decreases to 10%, fines increase to 35%   |
| 42          |                 |           | 100%                 |                     |             | SM          |   |
| 44          |                 |           |                      |                     |             |             |   |
| 46          |                 |           |                      |                     |             |             |   |
| 48          |                 |           | 100%                 |                     |             |             |   |
| 50          |                 |           |                      |                     |             |             | SILTY GRAVEL WITH SAND; moderate yellowish brown (10YR 5/4); weak induration; 60% gravel to 4 in., subrounded; 5% coarse sand, subrounded; 5% medium sand, subrounded; 15% fine sand, subrounded; 15% fines; medium dense; moist. |
| 52          |                 |           | 100%                 |                     |             | GM          |   |
| 54          |                 |           |                      |                     |             |             | SILTY GRAVEL; moderate brown (5YR 4/4); weak induration;  |

AEROJET Rev: 12/16/08 133317.GPJ SHAW.GDT 11/16/11

Continued Next Page



# Drilling Log

Sparge Well

**BW-4**

Page: 3 of 3

Project Aerojet ESTCP-NDMA Demo Owner Aerojet

Location Rancho Cordova, CA Proj. No. 133317

| Depth (ft.) | Well Completion | PID (ppm) | Sample ID % Recovery | Blow Count Recovery | Graphic Log | USCS Class. | Description<br>(Color, Texture, Structure)<br>Geologic Descriptions are Based on the USCS.  |
|-------------|-----------------|-----------|----------------------|---------------------|-------------|-------------|---|
| 56          |                 |           |                      |                     |             |             | 60% gravel to 4 in., subrounded; 30% fines; 10% fine sand, subrounded; medium dense; moist.   |
| 58          |                 |           | 100%                 |                     |             |             | SANDY SILT; moderate yellowish brown (10YR 5/4); weak induration; 70% fines, low plasticity; 30% fine sand; trace gravel; soft; moist.  |
| 60          |                 |           |                      |                     |             |             | Fines decrease to 60%, fine sand increases to 40%, no gravel, density increases to stiff  |
| 62          |                 |           | 100%                 |                     |             |             |   |
| 64          |                 |           |                      |                     |             | ML          |   |
| 66          |                 |           |                      |                     |             |             |   |
| 68          |                 |           | 100%                 |                     |             |             |   |
| 70          |                 |           | 100%                 |                     |             |             |   |
| 72          |                 |           | 100%                 |                     |             |             |   |
| 74          |                 |           | 100%                 |                     |             | SM          | SILTY SAND; moderate yellowish brown (10YR 5/4); weak induration; 10% coarse sand, subrounded; 25% medium sand, subrounded; 35% fine sand, subrounded; 30% fines; loose; wet. |
| 76          |                 |           | 100%                 |                     |             | CL          | LEAN CLAY WITH GRAVEL; olive brown (5Y 4/4); weak induration; 75% fines, low plasticity; 25% gravel to 4 in., weathered blue slate; stiff; damp.                              |
| 78          |                 |           |                      |                     |             |             | Boring terminated at 77 feet BGS  |
| 80          |                 |           |                      |                     |             |             |   |
| 82          |                 |           |                      |                     |             |             |   |
| 84          |                 |           |                      |                     |             |             |   |

AEROJET Rev: 12/16/08 133317.GPJ SHAW.GDT 11/16/11



# Drilling Log

Sparge Well  
**BW-5**

Page: 1 of 3

Project Aerojet ESTCP-NDMA Demo Owner Aerojet  
 Location Rancho Cordova, CA Proj. No. 133317  
 Surface Elev. NA Total Hole Depth 75 ft. North NA East NA  
 Top of Casing NA Water Level Initial NA Static NA Diameter 6 in.  
 Screen: Dia 2 in. Length 5 ft. Type/Slot Schumasoil 20 Micron  
 Casing: Dia 2 in. Length 63 ft. Type Sch 40 Blank PVC  
 Fill Material See Comments Rig/Core CRS 17-C/Sonic  
 Drill Co. Cascade Drilling Method Sonic Core  
 Driller Jeff Jones Log By Adam Norvelle Date 11/2/11 Permit # NA  
 Checked By \_\_\_\_\_ License No. \_\_\_\_\_

COMMENTS  
Annular Seal  
Bentonite-Cement Grout 0-57'  
Plug  
Bentonite Chips 57-60'  
Filter Pack  
#2/12 Sand 60-69'  
Screened Interval  
Schumasoil 20 Micron 63-68'  
Bottom Plug  
Bentonite Chips 69-71'  
Slough 71-75'

| Depth (ft.) | Well Completion | PID (ppm) | Sample ID % Recovery | Blow Count Recovery | Graphic Log | USCS Class. | Description<br>(Color, Texture, Structure)<br>Geologic Descriptions are Based on the USCS.   |
|-------------|-----------------|-----------|----------------------|---------------------|-------------|-------------|--|
| 0           |                 |           |                      |                     |             |             | Bare Ground  |
| 2           |                 |           | 80%                  |                     |             | ML          | GRAVELLY SILT WITH SAND; moderate yellowish brown (10YR 5/4); weak induration; 55% fines, no plasticity; 25% gravel to 3 in.; 5% coarse sand; 5% medium sand; 10% fine sand; stiff; dry.   |
| 4           |                 |           |                      |                     |             |             |  |
| 6           |                 |           | 80%                  |                     |             |             |  |
| 8           |                 |           |                      |                     |             |             |  |
| 10          |                 |           |                      |                     |             |             |  |
| 12          |                 |           | 100%                 |                     |             | SW-SM       | WELL-GRADED SAND WITH SILT; dark yellowish brown (10YR 4/2); moderate to strong induration; 35% coarse sand, subrounded; 30% medium sand, subrounded; 25% fine sand, subrounded; 10% fines; dense; moist.  |
| 14          |                 |           | 100%                 |                     |             |             |  |
| 16          |                 |           |                      |                     |             |             |  |
| 18          |                 |           | 100%                 |                     |             | SW          | WELL-GRADED SAND; dark yellowish brown (10YR 4/2); weak induration; 40% coarse sand, subrounded; 30% medium sand, subrounded; 25% fine sand, subrounded; 5% gravel to 0.5 in., subrounded; trace fines; loose; wet.                                |
| 20          |                 |           |                      |                     |             |             |  |
| 22          |                 |           | 80%                  |                     |             | SW-SM       | WELL-GRADED SAND WITH SILT AND GRAVEL; moderate yellowish brown (10YR 5/4); weak induration; 25% coarse sand, subrounded; 20% medium sand, subrounded; 20% fine sand, subrounded; 25% gravel to 2.5 in., subrounded; 10% fines; medium dense; wet. |
| 24          |                 |           |                      |                     |             |             |  |

AEROJET Rev: 12/16/08 133317.GPJ SHAW.GDT 11/16/11

Continued Next Page



# Drilling Log

Sparge Well

**BW-5**

Page: 2 of 3

Project Aerojet ESTCP-NDMA Demo

Owner Aerojet

Location Rancho Cordova, CA

Proj. No. 133317

| Depth (ft.) | Well Completion | PID (ppm) | Sample ID % Recovery | Blow Count Recovery | Graphic Log | USCS Class. | Description<br>(Color, Texture, Structure)<br>Geologic Descriptions are Based on the USCS.   |
|-------------|-----------------|-----------|----------------------|---------------------|-------------|-------------|--|
| 24          |                 |           |                      |                     |             |             |  |
| 26          |                 |           |                      |                     |             | SW-SM       |  |
| 28          |                 |           | 100%                 |                     |             |             |  |
| 30          |                 |           |                      |                     |             | SM          | SILTY SAND; dark yellowish brown (10YR 4/2); weak induration; 20% coarse sand, subrounded; 20% medium sand, subrounded; 35% fine sand, subrounded; 25% fines; medium dense; wet.   |
| 32          |                 |           | 67%                  |                     |             |             |  |
| 34          |                 |           | 100%                 |                     |             | SW          | WELL-GRADED SAND; dark yellowish brown (10YR 4/2); weak induration; 25% coarse sand, subrounded; 30% medium sand, subrounded; 40% fine sand, subrounded; 5% gravel to 0.5 in., subrounded; loose; wet.                               |
| 36          |                 |           |                      |                     |             |             |  |
| 38          |                 |           | 100%                 |                     |             |             |  |
| 40          |                 |           |                      |                     |             | ML          | GRAVELLY SILT; dark yellowish brown (10YR 4/2); weak induration; 55% fines, no plasticity; 35% gravel to 2 in.; 10% fine sand; firm; damp.   |
| 42          |                 |           | 100%                 |                     |             |             |  |
| 44          |                 |           | 67%                  |                     |             | SW-GM       | WELL-GRADED GRAVEL WITH SILT AND SAND; moderate yellowish brown (10YR 5/4); 60% gravel to 2.5 in., subrounded; 10% coarse sand, subrounded; 10% medium sand, subrounded; 10% fine sand, subrounded; 10% fines; medium dense; wet.    |
| 46          |                 |           |                      |                     |             | SW          | WELL-GRADED SAND; moderate yellowish brown (10YR 5/4); weak induration; 40% coarse sand, subrounded; 30% medium sand, subrounded; 25% fine sand, subrounded; 5% fines; medium dense; wet.  |
| 48          |                 |           | 80%                  |                     |             | ML          | GRAVELLY SILT; moderate yellowish brown (10YR 5/4); weak induration; 65% fines, no plasticity; 25% gravel to 1.5 in.; 10% fine sand; firm; moist.  |
| 50          |                 |           | 100%                 |                     |             | SM          | SILTY SAND WITH GRAVEL; moderate yellowish brown (10YR 5/4); weak induration; 15% coarse sand, subrounded; 25% medium sand, subrounded; 25% fine sand, subrounded; 20% gravel to 0.75 in., subrounded; 15% fines; medium dense; wet. |
| 52          |                 |           | 100%                 |                     |             | GM          | SILTY GRAVEL WITH SAND; dark yellowish brown (10YR 4/2); weak induration; 55% gravel to 4 in., subrounded; 30% fines; 15% fine sand, subrounded; dense; moist.   |
| 54          |                 |           | 67%                  |                     |             |             | Moderate yellowish brown, gravel (to 3 in.) decreases to 50%, 5% coarse sand, 5% medium sand, fine sand increases to 20%, fines  |

AEROJET Rev: 12/16/08 133317.GPJ SHAW.GDT 11/16/11

Continued Next Page



# Drilling Log

Sparge Well

**BW-5**

Page: 3 of 3

Project Aerojet ESTCP-NDMA Demo Owner Aerojet  
 Location Rancho Cordova, CA Proj. No. 133317

| Depth (ft.) | Well Completion | PID (ppm) | Sample ID % Recovery | Blow Count Recovery | Graphic Log | USCS Class. | Description<br>(Color, Texture, Structure)<br>Geologic Descriptions are Based on the USCS.   |
|-------------|-----------------|-----------|----------------------|---------------------|-------------|-------------|--|
| 56          |                 |           |                      |                     |             | SW-SM       | decrease to 20%<br>WELL-GRADED SAND WITH SILT; moderate yellowish brown (10YR 5/4); weak induration; 10% coarse sand, subrounded; 30% medium sand, subrounded; 50% fine sand, subrounded; 10% fines; medium dense; wet.  |
| 58          |                 |           | 80%                  |                     |             |             | SANDY SILT; moderate yellowish brown (10YR 5/4); weak induration; 60% fines, no plasticity; 40% fine sand; firm; moist.  |
| 60          |                 |           |                      |                     |             | ML          | GRAVELLY SILT WITH SAND; moderate yellowish brown (10YR 5/4); weak induration; 50% fines, no plasticity; 25% gravel to 1 in.; 5% medium sand; 20% fine sand; soft; wet.  |
| 62          |                 |           | 80%                  |                     |             |             | SANDY SILT; moderate yellowish brown (10YR 5/4); weak induration; 65% fines, no plasticity; 35% fine sand; stiff; moist.   |
| 64          |                 |           |                      |                     |             |             |  |
| 66          |                 |           | 100%                 |                     |             | GM          | SILTY GRAVEL WITH SAND; moderate yellowish brown (10YR 5/4); weak induration; 55% gravel to 1.5 in., subrounded; 25% fine sand, subrounded; 20% fines; medium dense; wet.  |
| 68          |                 |           | 100%                 |                     |             | SM          | SILTY SAND; moderate yellowish brown (10YR 5/4); weak induration; 60% fine sand, subrounded; 40% fines; medium dense; moist.   |
| 70          |                 |           | 100%                 |                     |             | ML          | SANDY SILT; moderate yellowish brown (10YR 5/4); weak induration; 60% fines, no plasticity; 40% fine sand; stiff; damp.  |
| 72          |                 |           | 100%                 |                     |             |             |  |
| 74          |                 |           | 100%                 |                     |             | GW          | WELL-GRADED GRAVEL WITH SAND; dark yellowish brown (10YR 4/2); weak induration; 80% gravel to 3.5 in., subrounded; 10% coarse sand, subrounded; 5% medium sand, subrounded; 5% fine sand, subrounded; trace fines; medium dense; wet.<br>Gravel (blue weathered slate to 4 in.) increases to 90%, fines increase to 5%, no coarse sand, no medium sand, density increases to dense, moisture content decreases to damp |
| 76          |                 |           |                      |                     |             |             | Boring terminated at 75 feet BGS   |
| 78          |                 |           |                      |                     |             |             |  |
| 80          |                 |           |                      |                     |             |             |  |
| 82          |                 |           |                      |                     |             |             |  |
| 84          |                 |           |                      |                     |             |             |  |

AEROJET Rev: 12/16/08 133317.GPJ SHAW.GDT 11/16/11



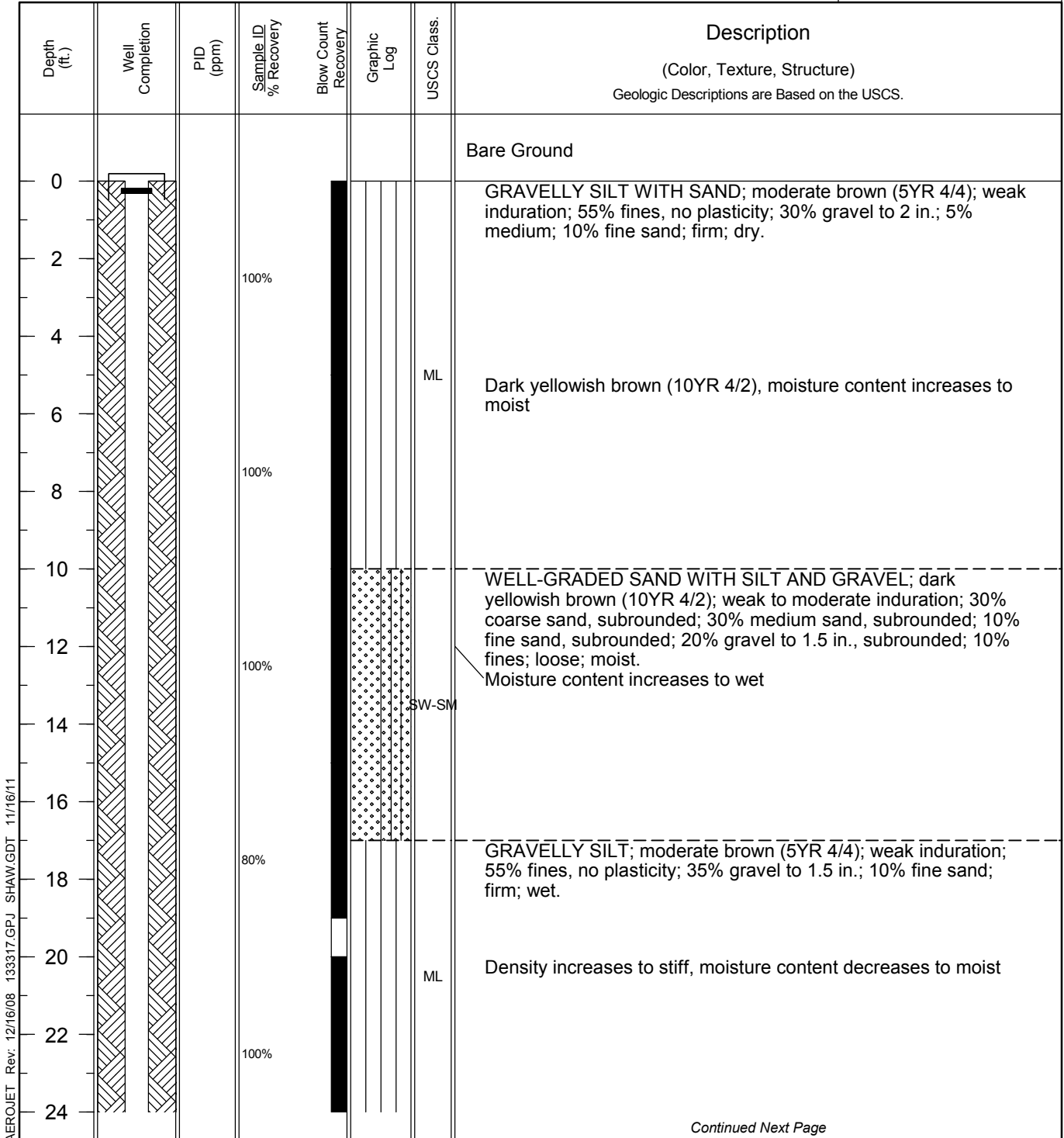
# Drilling Log

Monitoring Well  
**PMW-5**

Page: 1 of 3

Project Aerojet ESTCP-NDMA Demo Owner Aerojet  
 Location Rancho Cordova, CA Proj. No. 133317  
 Surface Elev. NA Total Hole Depth 75 ft. North NA East NA  
 Top of Casing NA Water Level Initial NA Static NA Diameter 6 in.  
 Screen: Dia 2 in. Length 5 ft. Type/Slot Sch 40 PVC/0.010 in.  
 Casing: Dia 2 in. Length 57 ft. Type Sch 40 Blank PVC  
 Fill Material See Comments Rig/Core CRS 17-C/Sonic  
 Drill Co. Cascade Drilling Method Sonic Core  
 Driller Jeff Jones Log By Adam Norvelle Date 10/28/11 Permit # NA  
 Checked By \_\_\_\_\_ License No. \_\_\_\_\_

COMMENTS  
Annular Seal  
Bentonite-Cement Grout 0-51'  
Plug  
Bentonite Chips 51-54'  
Filter Pack  
#2/12 Sand 54-63'  
Screened Interval  
Sch 40 0.010" Machine Slot  
PVC 57-62'  
Bottom Plug  
Bentonite Chips 63-75'



AEROJET Rev: 12/16/08 133317.GPJ SHAW.GDT 11/16/11

Continued Next Page



# Drilling Log

Monitoring Well  
**PMW-5**

Page: 2 of 3

Project Aerojet ESTCP-NDMA Demo Owner Aerojet  
 Location Rancho Cordova, CA Proj. No. 133317

| Depth (ft.) | Well Completion | PID (ppm) | Sample ID % Recovery | Blow Count Recovery | Graphic Log | USCS Class. | Description<br>(Color, Texture, Structure)<br>Geologic Descriptions are Based on the USCS.  |
|-------------|-----------------|-----------|----------------------|---------------------|-------------|-------------|---|
| 24          |                 |           |                      |                     |             |             |   |
| 26          |                 |           |                      |                     |             | ML          |   |
| 28          |                 |           | 100%                 |                     |             | SM          | SILTY SAND; pale yellowish brown (10YR 6/2); 15% coarse sand, subrounded; 25% medium sand, subrounded; 30% fine sand, subrounded; 30% fines; loose; wet.                                      |
| 30          |                 |           |                      |                     |             |             |   |
| 32          |                 |           | 100%                 |                     |             | ML          | GRAVELLY SILT; moderate yellowish brown (10YR 5/4); weak induration; 60% fines, no plasticity; 35% gravel to 1.5 in.; 5% fine sand; firm; wet.  |
| 34          |                 |           |                      |                     |             |             |   |
| 36          |                 |           |                      |                     |             | SW-SM       | WELL-GRADED SAND WITH SILT; moderate yellowish brown (10YR 5/4); weak induration; 25% coarse sand, subrounded; 30% medium sand, subrounded; 35% fine sand, subrounded; 10% fines; loose; wet. |
| 38          |                 |           | 100%                 |                     |             |             | GRAVELLY SILT; moderate yellowish brown (10YR 5/4); weak induration; 55% fines, no plasticity; 30% gravel to 1.5 in.; 5% medium sand; 10% fine sand; firm; wet.                               |
| 40          |                 |           |                      |                     |             |             |   |
| 42          |                 |           | 100%                 |                     |             |             | SANDY SILT; moderate yellowish brown (10YR 5/4); weak induration; 60% fines, no plasticity; 35% fine sand; 5% gravel to 0.5 in.; firm; wet.   |
| 44          |                 |           |                      |                     |             |             |   |
| 46          |                 |           |                      |                     |             | ML          | GRAVELLY SILT; moderate yellowish brown (10YR 5/4); weak induration; 60% fines, no plasticity; 30% gravel to 3.5 in.; 10% fine sand; firm; wet.   |
| 48          |                 |           | 80%                  |                     |             |             |   |
| 50          |                 |           |                      |                     |             |             |   |
| 52          |                 |           | 100%                 |                     |             |             | SANDY SILT; moderate yellowish brown (10YR 5/4); weak induration; 60% fines, no plasticity; 35% fine sand; 5% gravel to 0.75 in.; firm; moist;  |
| 54          |                 |           |                      |                     |             |             |   |

AEROJET Rev: 12/16/08 133317.GPJ SHAW.GDT 11/16/11

Continued Next Page



# Drilling Log

Monitoring Well

**PMW-5**

Page: 3 of 3

Project Aerojet ESTCP-NDMA Demo Owner Aerojet

Location Rancho Cordova, CA Proj. No. 133317

| Depth (ft.) | Well Completion | PID (ppm) | Sample ID % Recovery | Blow Count Recovery | Graphic Log | USCS Class. | Description<br>(Color, Texture, Structure)<br>Geologic Descriptions are Based on the USCS.  |
|-------------|-----------------|-----------|----------------------|---------------------|-------------|-------------|---|
| 56          |                 |           |                      |                     |             |             | Fine sand increases to 40%, no gravel, density increases to stiff   |
| 58          |                 |           | 100%                 |                     |             |             |   |
| 60          |                 |           |                      |                     |             |             |   |
| 62          |                 |           | 100%                 |                     |             | ML          |   |
| 64          |                 |           |                      |                     |             |             |   |
| 66          |                 |           |                      |                     |             |             | GRAVELLY SILT; moderate yellowish brown (10YR 5/4); weak induration; 70% fines, low plasticity; 30% gravel to 2.5 in.; stiff; moist   |
| 68          |                 |           | 100%                 |                     |             |             | SILT; moderate yellowish brown (10YR 5/4); weak induration; 90% fines, low plasticity; 10% fine sand; stiff; damp.  |
| 70          |                 |           |                      |                     |             |             |   |
| 72          |                 |           |                      |                     |             | CL          | GRAVELLY LEAN CLAY; moderate yellowish brown (10YR 5/4) to light olive (10Y 5/4); weak induration; 60% fines, low plasticity; 40% gravel to 3.5 in., weathered blue slate; stiff; damp. |
| 74          |                 |           | 100%                 |                     |             |             |   |
| 76          |                 |           |                      |                     |             |             | Boring terminated at 75 feet BGS  |
| 78          |                 |           |                      |                     |             |             |   |
| 80          |                 |           |                      |                     |             |             |   |
| 82          |                 |           |                      |                     |             |             |   |
| 84          |                 |           |                      |                     |             |             |   |

AEROJET Rev: 12/16/08 133317.GPJ SHAW.GDT 11/16/11





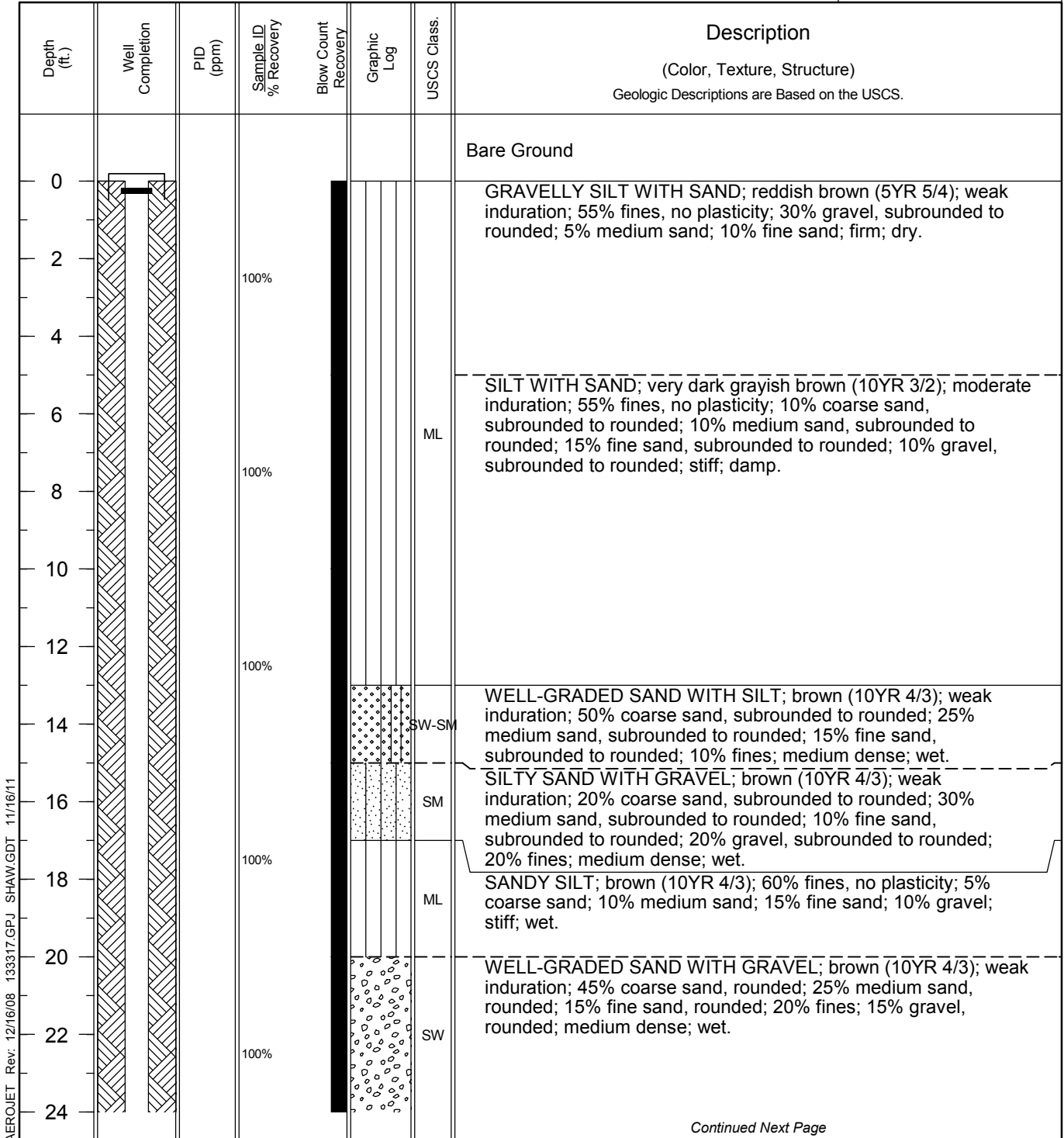
# Drilling Log

Monitoring Well  
**PMW-6**

Page: 1 of 3

Project Aerojet ESTCP-NDMA Demo Owner Aerojet  
 Location Rancho Cordova, CA Proj. No. 133317  
 Surface Elev. NA Total Hole Depth 73 ft. North NA East NA  
 Top of Casing NA Water Level Initial NA Static NA Diameter 6 in.  
 Screen: Dia 2 in. Length 5 ft. Type/Slot Sch 40 PVC/0.010 in.  
 Casing: Dia 2 in. Length 60 ft. Type Sch 40 Blank PVC  
 Fill Material See Comments Rig/Core CRS 17-C/Sonic  
 Drill Co. Cascade Drilling Method Sonic Core  
 Driller Jeff Jones Log By B. Stempson / A. Norvelle Date 10/27/11 Permit # NA  
 Checked By \_\_\_\_\_ License No. \_\_\_\_\_

COMMENTS  
Annular Seal  
Bentonite-Cement Grout 0-55'  
Plug  
Bentonite Chips 55-58'  
Filter Pack  
#2/12 Sand 58-67'  
Screened Interval  
Sch 40 0.010" Machine Slot  
PVC 60-65'  
Bottom Plug  
Bentonite Chips 67-73'



AEROJET Rev: 12/16/08 133317.GPJ SHAW.GDT 11/16/11

Continued Next Page



# Drilling Log

Monitoring Well

**PMW-6**

Page: 2 of 3

Project Aerojet ESTCP-NDMA Demo Owner Aerojet

Location Rancho Cordova, CA Proj. No. 133317

| Depth (ft.) | Well Completion | PID (ppm) | Sample ID % Recovery | Blow Count Recovery | Graphic Log | USCS Class. | Description<br>(Color, Texture, Structure)<br>Geologic Descriptions are Based on the USCS.  |
|-------------|-----------------|-----------|----------------------|---------------------|-------------|-------------|---|
| 24          |                 |           |                      |                     |             | SW          |   |
| 26          |                 |           |                      |                     |             | ML          | GRAVELLY SILT WITH SAND; dark grayish brown (10YR 4/2); weak induration; 55% fines, no plasticity; 25% gravel; 10% coarse sand; 5% medium sand; 5% fine sand; firm; wet.    |
| 28          |                 |           | 100%                 |                     |             | SM          | SILTY SAND; grayish brown (10YR 5/2); weak induration; 15% medium sand, subrounded to rounded; 55% fine sand, subrounded to rounded; 30% fines; medium dense; wet.          |
| 30          |                 |           |                      |                     |             |             | SANDY SILT; brown (10YR 4/3); weak induration; 70% fines, no plasticity; 10% medium sand; 20% fine sand; firm; wet.   |
| 32          |                 |           |                      |                     |             |             |   |
| 34          |                 |           |                      |                     |             |             | GRAVELLY SILT WITH SAND; brown (10YR 4/3); weak induration; 55% fines, no plasticity; 25% gravel; 10% medium sand; 10% fine sand; trace coarse sand; soft; wet.             |
| 36          |                 |           | 43%                  |                     |             |             |   |
| 38          |                 |           |                      |                     |             |             |   |
| 40          |                 |           |                      |                     |             |             | GRAVELLY SILT; dark grayish brown (10YR 4/2); weak induration; 65% fines, no plasticity; 25% gravel; 10% fine sand; trace coarse sand; trace medium sand; very stiff; damp. |
| 42          |                 |           | 100%                 |                     |             | ML          |   |
| 44          |                 |           |                      |                     |             |             |   |
| 46          |                 |           | 100%                 |                     |             |             |   |
| 48          |                 |           | 100%                 |                     |             |             |   |
| 50          |                 |           | 100%                 |                     |             |             | Dark reddish brown (2.5YR 3/3) and dark grayish brown (10YR 4/2) mottling   |
| 52          |                 |           | 100%                 |                     |             |             |   |
| 54          |                 |           | 100%                 |                     |             |             | SANDY SILT; dark yellowish brown (10YR 4/4); weak induration; 70% fines, no plasticity; 30% fine sand; stiff; wet.  |

AEROJET Rev: 12/16/08 133317.GPJ SHAW.GDT 11/16/11

Continued Next Page



# Drilling Log

Monitoring Well

**PMW-6**

Page: 3 of 3

Project Aerojet ESTCP-NDMA Demo Owner Aerojet

Location Rancho Cordova, CA Proj. No. 133317

| Depth (ft.) | Well Completion | PID (ppm) | Sample ID % Recovery | Blow Count Recovery | Graphic Log | USCS Class. | Description<br>(Color, Texture, Structure)<br>Geologic Descriptions are Based on the USCS.   |
|-------------|-----------------|-----------|----------------------|---------------------|-------------|-------------|--|
| 56          |                 |           |                      |                     |             |             | Fines decrease to 60%, fine sand increases to 40%  |
| 58          |                 |           | 100%                 |                     |             | ML          |  |
| 60          |                 |           |                      |                     |             |             | SILTY SAND; moderate yellowish brown (10YR 5/4); weak induration; 65% fine sand, subrounded; 35% fines; loose; wet.                              |
| 62          |                 |           | 100%                 |                     |             |             |  |
| 64          |                 |           |                      |                     |             | SM          | Density increases to dense   |
| 66          |                 |           |                      |                     |             |             |  |
| 68          |                 |           | 100%                 |                     |             |             | SANDY SILT; moderate yellowish brown (10YR 5/4); weak induration; 65% fines, low plasticity; 35% fine sand; stiff; wet.                          |
| 70          |                 |           |                      |                     |             | ML          |  |
| 72          |                 |           | 100%                 |                     |             | CL          | LEAN CLAY WITH GRAVEL; olive brown (5Y 4/4); weak induration; 75% fines, low plasticity; 25% gravel to 4 in., weathered blue slate; firm; moist. |
| 74          |                 |           |                      |                     |             |             | Boring terminated at 73 feet BGS   |
| 76          |                 |           |                      |                     |             |             |  |
| 78          |                 |           |                      |                     |             |             |  |
| 80          |                 |           |                      |                     |             |             |  |
| 82          |                 |           |                      |                     |             |             |  |
| 84          |                 |           |                      |                     |             |             |  |

AEROJET Rev: 12/16/08 133317.GPJ SHAW.GDT 11/16/11



# Drilling Log

Monitoring Well  
**DB-1**

Page: 1 of 5

Project Aerojet ESTCP-NDMA Demo Owner Aerojet  
 Location Rancho Cordova, CA Proj. No. 133317  
 Surface Elev. NA Total Hole Depth 118 ft. North NA East NA  
 Top of Casing NA Water Level Initial NA Static NA Diameter 6 in.  
 Screen: Dia 2 in. Length 10 ft. Type/Slot Sch 40 PVC/0.020 in.  
 Casing: Dia 2 in. Length 104 ft. Type Sch 40 Blank PVC  
 Fill Material See Comments Rig/Core CS500/Sonic  
 Drill Co. Cascade Drilling Method Sonic Core  
 Driller Jason Hernandez Log By Bryan Stempson Date 4/21/11 Permit # NA  
 Checked By \_\_\_\_\_ License No. \_\_\_\_\_

COMMENTS  
Annular Seal  
Bentonite-Cement Grout 0-97.5'  
Plug  
Bentonite Chips 97.5-100.5'  
Filter Pack  
#3 Sand 100.5-117'  
Screened Interval  
Sch 40 0.020" Machine Slot PVC  
104-114'  
Bottom Plug  
Slough 117-118'

| Depth (ft.) | Well Completion | PID (ppm) | Sample ID % Recovery | Blow Count Recovery | Graphic Log | USCS Class. | Description<br>(Color, Texture, Structure)<br>Geologic Descriptions are Based on the USCS.  |
|-------------|-----------------|-----------|----------------------|---------------------|-------------|-------------|---|
| 0           |                 |           |                      |                     |             |             | Bare Ground   |
| 0 - 12      |                 | 0.0       |                      |                     |             | SM          | SILTY SAND WITH GRAVEL; dark yellowish brown (10YR 3/4); weak induration; 5% coarse sand, rounded to subrounded; 15% medium sand, rounded to subrounded; 30% fine sand, rounded to subrounded; 30% gravel, rounded to subrounded; 20% fines; medium dense; damp |
| 12 - 18     |                 | 0.0       |                      |                     |             | ML          | SILT WITH SAND; strong brown (7.5YR 4/6); weak induration; 75% fines, low plasticity; 25% fine sand; stiff; damp  |
| 18 - 24     |                 | 0.0       |                      |                     |             | SP          | POORLY GRADED SAND; strong brown (7.5YR 4/6); weak induration; trace medium sand, rounded to subrounded; 100% fine sand, rounded to subrounded; dense; damp<br>Yellowish brown (10YR 5/4).  |
| 24 - 118    |                 |           |                      |                     |             | SM          | SILTY SAND WITH GRAVEL; dark yellowish brown (10YR 4/4); weak induration; 5% coarse sand, rounded to subrounded; 15%  |

AEROJET Rev: 12/16/08 133317.GPJ SHAW.GDT 5/18/11

Continued Next Page



# Drilling Log

Monitoring Well

**DB-1**

Page: 2 of 5

Project Aerojet ESTCP-NDMA Demo Owner Aerojet

Location Rancho Cordova, CA Proj. No. 133317

| Depth (ft.) | Well Completion | PID (ppm) | Sample ID % Recovery | Blow Count Recovery | Graphic Log | USCS Class. | Description<br>(Color, Texture, Structure)<br>Geologic Descriptions are Based on the USCS.   |
|-------------|-----------------|-----------|----------------------|---------------------|-------------|-------------|--|
| 24          |                 | 0.0       |                      |                     |             | SM          | medium sand, rounded to subrounded; 30% fine sand, rounded to subrounded; 30% gravel, rounded to subrounded; 20% fines; dense; damp  |
| 26          |                 |           |                      |                     |             |             |  |
| 28          |                 |           |                      |                     |             |             | Switched drilling method to air rotary, lithology taken from cuttings, no samples collected; drill chatter, driller notes sand layer between 31-35' bgs, not observed in cuttings. |
| 30          |                 |           |                      |                     |             |             |  |
| 32          |                 |           |                      |                     |             |             |  |
| 34          |                 |           |                      |                     |             |             |  |
| 36          |                 |           |                      |                     |             |             |  |
| 38          |                 |           |                      |                     |             |             | 0.0  |
| 40          |                 |           |                      |                     |             |             |  |
| 42          |                 |           |                      |                     |             |             |  |
| 44          |                 | 0.0       |                      |                     |             | SM          | Driller notes possible sand between 44-46' bgs, not observed in cuttings.  |
| 46          |                 |           |                      |                     |             |             |  |
| 48          |                 |           |                      |                     |             |             |  |
| 50          |                 |           |                      |                     |             |             |  |
| 52          |                 | 0.0       |                      |                     |             | SM          |  |
| 54          |                 |           |                      |                     |             |             |  |

AEROJET Rev: 12/16/08 133317.GPJ SHAW.GDT 5/18/11

Continued Next Page



# Drilling Log

Monitoring Well

**DB-1**

Page: 3 of 5

Project Aerojet ESTCP-NDMA Demo Owner Aerojet

Location Rancho Cordova, CA Proj. No. 133317

| Depth (ft.) | Well Completion | PID (ppm) | Sample ID % Recovery | Blow Count Recovery | Graphic Log | USCS Class. | Description<br>(Color, Texture, Structure)<br>Geologic Descriptions are Based on the USCS.   |
|-------------|-----------------|-----------|----------------------|---------------------|-------------|-------------|--|
| 56          |                 |           |                      |                     |             |             |  |
| 58          |                 | 0.0       |                      |                     |             | SM          |  |
| 60          |                 |           |                      |                     |             |             | Drill chatter stops.   |
| 62          |                 |           |                      |                     |             | ML          | SILT; brown (7.5YR 5/4); weak induration; 85% fines, low plasticity; 15% fine sand; stiff; damp  |
| 64          |                 |           |                      |                     |             |             |  |
| 66          |                 | 0.0       |                      |                     |             |             | SILTY SAND WITH GRAVEL; dark yellowish brown (10YR 4/4); weak induration; 5% coarse sand, rounded to subrounded; 15% medium sand, rounded to subrounded; 30% fine sand, rounded to subrounded; 30% gravel, rounded to subrounded; 20% fines; dense; damp |
| 68          |                 |           |                      |                     |             |             | Switched drilling method back to sonic.  |
| 70          |                 |           |                      |                     |             |             | Dark yellowish brown (10YR 3/4), gravel consists of large cobbles, fines increase to 30%, fine sand decreases to 20%.  |
| 72          |                 |           |                      |                     |             |             |  |
| 74          |                 | 100%      |                      |                     |             | SM          |  |
| 76          |                 | 0.0       |                      |                     |             |             |  |
| 78          |                 |           |                      |                     |             |             |  |
| 80          |                 |           |                      |                     |             |             | CLAYEY GRAVEL WITH SAND; brown (10YR 4/3); weak induration; 50% gravel, medium to coarse, subrounded to subangular; 25% fines, low to medium plasticity; trace coarse sand; 5% medium sand; 20% fine sand; dense; moist                                  |
| 82          |                 | 100%      |                      |                     |             | GC          |  |
| 84          |                 |           |                      |                     |             |             |  |

AEROJET Rev: 12/16/08 133317.GPJ SHAW.GDT 5/18/11

Continued Next Page



# Drilling Log

Monitoring Well

**DB-1**

Page: 4 of 5

Project Aerojet ESTCP-NDMA Demo Owner Aerojet  
 Location Rancho Cordova, CA Proj. No. 133317

| Depth (ft.) | Well Completion | PID (ppm) | Sample ID % Recovery | Blow Count Recovery | Graphic Log | USCS Class. | Description<br>(Color, Texture, Structure)<br>Geologic Descriptions are Based on the USCS.  |
|-------------|-----------------|-----------|----------------------|---------------------|-------------|-------------|---|
| 86          |                 |           |                      |                     |             | GC          |   |
| 88          |                 | 100%      |                      |                     |             | CL          | LEAN CLAY WITH GRAVEL; very dark brown (10YR 2/2); 80% fines, low plasticity; 20% gravel; trace medium sand; trace fine sand; stiff; moist  |
| 90          |                 | 0.0       |                      |                     |             | ML          | SILT WITH SAND; dark yellowish brown (10YR 4/4); weak induration; 85% fines, no plasticity to low plasticity; trace medium sand; 15% fine sand; stiff; moist  |
| 92          |                 | 100%      |                      |                     |             |             | SANDY SILT WITH GRAVEL; brown (10YR 4/3); weak induration; 70% fines, low plasticity; 5% medium sand; 10% fine sand; 15% gravel, coarse to cobble size; stiff; moist  |
| 94          |                 | 0.0       |                      |                     |             |             |   |
| 96          |                 |           |                      |                     |             | ML          |   |
| 98          |                 | 100%      |                      |                     |             |             |   |
| 100         |                 |           |                      |                     |             |             |   |
| 102         |                 |           |                      |                     |             |             |   |
| 104         |                 |           |                      |                     |             | SM          | SILTY SAND WITH GRAVEL; brown (10YR 4/3); weak induration; 5% coarse sand, rounded to subrounded; 15% medium sand, rounded to subrounded; 25% fine sand, rounded to subrounded; 35% fines; 20% gravel, rounded to subrounded; dense; wet  |
| 106         |                 | 100%      |                      |                     |             |             |   |
| 108         |                 |           |                      |                     |             | CL-ML       | Laminated layers of silt and clay.<br>-SILT; light greenish gray (GLEYS 7/1); moderate induration; 100% fines, no plasticity; trace medium sand; trace fine sand; very stiff; dry<br>-LEAN CLAY; brown (10YR 4/3); weak induration; 100% fines, low plasticity; very stiff; dry |
| 110         |                 |           |                      |                     |             |             |   |
| 112         |                 |           |                      |                     |             | SM          | SILTY SAND WITH GRAVEL; brown (10YR 4/3); weak induration; 5% coarse sand, rounded to subrounded; 15% medium sand, rounded to subrounded; 25% fine sand, rounded to subrounded; 35% fines; 20% gravel, rounded to subrounded; dense; moist to wet                               |
| 114         |                 | 100%      |                      |                     |             |             |   |
| 116         |                 |           |                      |                     |             | CL          | LEAN CLAY WITH GRAVEL; brown (10YR 4/3); weak induration; 85% fines, low plasticity; 15% gravel; hard; dry  |

AEROJET Rev: 12/16/08 133317.GPJ SHAW.GDT 5/18/11

Continued Next Page



# Drilling Log

Monitoring Well

**DB-1**

Page: 5 of 5

Project Aerojet ESTCP-NDMA Demo Owner Aerojet

Location Rancho Cordova, CA Proj. No. 133317

| Depth (ft.) | Well Completion | PID (ppm) | Sample ID % Recovery | Blow Count Recovery | Graphic Log | USCS Class. | Description<br>(Color, Texture, Structure)<br>Geologic Descriptions are Based on the USCS. |
|-------------|-----------------|-----------|----------------------|---------------------|-------------|-------------|--|
| 118         |                 |           |                      |                     |             | CL          |  |
| 120         |                 |           |                      |                     |             |             | Boring terminated at planned depth.  |
| 122         |                 |           |                      |                     |             |             |  |
| 124         |                 |           |                      |                     |             |             |  |
| 126         |                 |           |                      |                     |             |             |  |
| 128         |                 |           |                      |                     |             |             |  |
| 130         |                 |           |                      |                     |             |             |  |
| 132         |                 |           |                      |                     |             |             |  |
| 134         |                 |           |                      |                     |             |             |  |
| 136         |                 |           |                      |                     |             |             |  |
| 138         |                 |           |                      |                     |             |             |  |
| 140         |                 |           |                      |                     |             |             |  |
| 142         |                 |           |                      |                     |             |             |  |
| 144         |                 |           |                      |                     |             |             |  |
| 146         |                 |           |                      |                     |             |             |  |

AEROJET Rev: 12/16/08 133317.GPJ SHAW.GDT 5/18/11





# Drilling Log

Monitoring Well  
**DB-2/PMW-1**

Page: 1 of 3

Project Aerojet ESTCP-NDMA Demo Owner Aerojet  
 Location Rancho Cordova, CA Proj. No. 133317  
 Surface Elev. NA Total Hole Depth 81 ft. North NA East NA  
 Top of Casing NA Water Level Initial NA Static NA Diameter 6 in.  
 Screen: Dia 2 in. Length 5 ft. Type/Slot Sch 40 PVC/0.020 in.  
 Casing: Dia 2 in. Length 60 ft. Type Sch 40 Blank PVC  
 Fill Material See Comments Rig/Core CS500/Sonic  
 Drill Co. Cascade Drilling Method Sonic Core  
 Driller Jason Hernandez Log By Bryan Stempson Date 4/23/11 Permit # NA  
 Checked By \_\_\_\_\_ License No. \_\_\_\_\_

COMMENTS  
Annular Seal  
Bentonite-Cement Grout 0-52'  
Plug  
Bentonite Chips 52-57'  
Filter Pack  
#3 Sand 57-68'  
Screened Interval  
Sch 40 0.020" Machine Slot PVC  
60-65'  
Bottom Plug  
Bentonite Chips 68-81'

| Depth (ft.) | Well Completion | PID (ppm) | Sample ID % Recovery | Blow Count Recovery | Graphic Log | USCS Class. | Description<br>(Color, Texture, Structure)<br>Geologic Descriptions are Based on the USCS.   |
|-------------|-----------------|-----------|----------------------|---------------------|-------------|-------------|--|
| 0           |                 |           |                      |                     |             |             | Bare Ground<br>Start with air rotary (cuttings).   |
| 2           |                 | 0.0       |                      |                     |             |             | GRAVELLY SILT WITH SAN; reddish brown (5YR 5/4); weak induration; 55% fines, no plasticity; 30% gravel, well rounded; 5% medium sand; 10% fine sand; stiff; dry<br><br>Drill chatter.  |
| 4           |                 |           |                      |                     |             |             |  |
| 6           |                 |           |                      |                     |             |             |  |
| 8           |                 |           |                      |                     |             | ML          |  |
| 10          |                 | 0.0       |                      |                     |             |             | Brown (10YR 5/2).  |
| 12          |                 |           |                      |                     |             |             |  |
| 14          |                 |           |                      |                     |             |             |  |
| 16          |                 |           |                      |                     |             |             |  |
| 18          |                 | 0.0       |                      |                     |             |             | Drill chatter increases.   |
| 20          |                 |           |                      |                     |             | GM          | SILTY GRAVEL WITH SAND; brown (10YR 5/2); weak induration; 50% gravel, rounded to subrounded; 25% fines; trace coarse sand, rounded to subrounded; 10% medium sand, rounded to subrounded; 15% fine sand, rounded to subrounded; medium dense; wet<br>Switch drilling method to sonic. |
| 22          |                 |           |                      |                     |             | SW          | WELL-GRADED SAND; very dark brown (10YR 2/2); moderate induration; 60% coarse sand, subrounded; 25% medium sand, subrounded; 15% fine sand, subrounded; dense; wet<br>Dark grayish brown (10YR 4/2), trace gravel, trace silt.   |
| 24          |                 |           |                      |                     |             |             |  |

AEROJET Rev: 12/16/08 133317.GPJ SHAW.GDT 5/18/11

Continued Next Page



# Drilling Log

Monitoring Well  
**DB-2/PMW-1**

Page: 2 of 3

Project Aerojet ESTCP-NDMA Demo Owner Aerojet  
 Location Rancho Cordova, CA Proj. No. 133317

| Depth (ft.) | Well Completion | PID (ppm) | Sample ID % Recovery | Blow Count Recovery | Graphic Log | USCS Class. | Description<br>(Color, Texture, Structure)<br>Geologic Descriptions are Based on the USCS.  |
|-------------|-----------------|-----------|----------------------|---------------------|-------------|-------------|---|
| 24          |                 |           | 100%                 |                     |             | SW          |   |
| 26          |                 | 1.1       |                      |                     |             |             | SILTY SAND WITH GRAVEL; dark grayish brown (10YR 4/2); weak induration; 10% coarse sand, rounded to subrounded; 30% medium sand, rounded to subrounded; 15% fine sand, rounded to subrounded; 25% fines; 20% gravel, rounded to subrounded; medium dense; wet   |
| 28          |                 |           |                      |                     |             |             |   |
| 30          |                 |           | 100%                 |                     |             | SM          | SILTY SAND; dark grayish brown (10YR 4/2); weak induration; 10% medium sand, rounded to subrounded; 60% fine sand, rounded to subrounded; 30% fines; dense; wet   |
| 32          |                 |           |                      |                     |             |             |   |
| 34          |                 |           | 100%                 |                     |             |             |   |
| 36          |                 |           | 100%                 |                     |             |             |   |
| 38          |                 | 1.0       | 100%                 |                     |             | ML          | GRAVELLY SILT; dark grayish brown (10YR 4/2); moderate induration; 55% fines, no plasticity; 25% fine gravel, subangular; 10% medium sand, subangular; 10% fine sand, subangular; stiff; dry; potential lahar layer<br>SILT; grayish brown (10YR 5/2); 100% fines, low plasticity; trace gravel; trace sand; stiff; wet   |
| 40          |                 |           | 100%                 |                     |             | SW          | GRAVELLY SILT; dark grayish brown (10YR 4/2); moderately indurated; 60% fines, no plasticity; 20% gravel, subangular; 5% medium sand, subangular; 15% fine sand, subangular; very stiff; dry<br>WELL-GRADED SAND; very dark brown (10YR 2/2); moderate induration; 60% coarse sand, rounded to subrounded; 25% medium sand, rounded to subrounded; 15% fine sand, rounded to subrounded; dense; wet |
| 42          |                 |           |                      |                     |             |             |   |
| 44          |                 |           | 100%                 |                     |             | SM          | SILTY SAND; brown (10YR 4/3); weak induration; 15% coarse sand, rounded to subrounded; 15% medium sand, rounded to subrounded; 40% fine sand, rounded to subrounded; 30% fines; dense; moist  |
| 46          |                 | 0.0       |                      |                     |             |             |   |
| 48          |                 |           |                      |                     |             |             |   |
| 50          |                 |           |                      |                     |             |             | GRAVELLY SILT WITH SAND; brown (10YR 4/3); moderate induration; 55% fines, no plasticity to low plasticity; 25% gravel; trace coarse sand; 10% medium sand; 10% fines; very stiff; dry  |
| 52          |                 |           | 29%                  |                     |             | ML          |   |
| 54          |                 |           |                      |                     |             |             |   |

AEROJET Rev: 12/16/08 133317.GPJ SHAW.GDT 5/18/11

Continued Next Page



# Drilling Log

Monitoring Well  
**DB-2/PMW-1**

Page: 3 of 3

Project Aerojet ESTCP-NDMA Demo Owner Aerojet  
 Location Rancho Cordova, CA Proj. No. 133317

| Depth (ft.) | Well Completion | PID (ppm) | Sample ID % Recovery | Blow Count Recovery | Graphic Log | USCS Class. | Description<br>(Color, Texture, Structure)<br>Geologic Descriptions are Based on the USCS.  |
|-------------|-----------------|-----------|----------------------|---------------------|-------------|-------------|---|
| 56          |                 |           | 100%                 |                     |             | SW          | WELL-GRADED SAND; very dark brown (10YR 2/2); moderate induration; 60% coarse sand, subrounded to subangular; 25% medium sand, subrounded to subangular; 15% fine sand, subrounded to subangular; dense; wet  |
| 58          |                 |           |                      |                     |             | GM          | SILTY GRAVEL; brown (10YR 4/3); weak induration; 60% gravel, rounded with large pieces of angular weathered slate; 25% fines; trace coarse sand; 5% medium sand; 10% fine sand; dense; dry  |
| 60          |                 |           | 100%                 |                     |             | GW          | WELL-GRADED GRAVEL WITH SAND; black (10YR 2/1); moderate induration to strong induration; 70% gravel, rounded to angular; 20% coarse sand, subangular to angular; 10% medium sand, subangular to angular; trace fine sand, subangular to angular; very dense; wet |
| 62          |                 |           |                      |                     |             |             |   |
| 64          |                 | 0.0       |                      |                     |             |             |   |
| 66          |                 |           |                      |                     |             |             | SILT WITH SAND; dark yellowish brown (10YR 4/4); weak induration; 75% fines, low plasticity; 25% fine sand; firm to stiff; damp   |
| 68          |                 |           |                      |                     |             | ML          |   |
| 70          |                 |           |                      |                     |             |             |   |
| 72          |                 |           |                      |                     |             |             |   |
| 74          |                 |           |                      |                     |             |             |   |
| 76          |                 |           |                      |                     |             | CL          | LEAN CLAY WITH GRAVEL; very dark grayish brown (10YR 3/2); weak induration to moderate induration; 75% fines, low plasticity; 25% gravel, rounded; trace coarse sand; trace medium sand; trace fine sand; very stiff; dry   |
| 78          |                 | 0.0       |                      |                     |             |             | SLATE; greenish gray; (GLEY 6/1)  |
| 80          |                 |           |                      |                     |             |             |   |
| 82          |                 |           |                      |                     |             |             | Boring terminated at planned depth.   |
| 84          |                 |           |                      |                     |             |             |   |

AEROJET Rev: 12/16/08 133317.GPJ SHAW.GDT 5/18/11



# Drilling Log

Monitoring Well  
**DB-3/BSW-1**

Page: 1 of 3

Project Aerojet ESTCP-NDMA Demo Owner Aerojet  
 Location Rancho Cordova, CA Proj. No. 133317  
 Surface Elev. NA Total Hole Depth 80 ft. North NA East NA  
 Top of Casing NA Water Level Initial NA Static NA Diameter 6 in.  
 Screen: Dia 2 in. Length 20 ft. Type/Slot Sch 40 PVC/0.020 in.  
 Casing: Dia 2 in. Length 52 ft. Type Sch 40 Blank PVC  
 Fill Material See Comments Rig/Core CS500/Sonic  
 Drill Co. Cascade Drilling Method Sonic Core  
 Driller Jason Hernandez Log By Bryan Stempson Date 4/25/11 Permit # NA  
 Checked By \_\_\_\_\_ License No. \_\_\_\_\_

COMMENTS  
Annular Seal  
Bentonite-Cement Grout 0-46'  
Plug  
Bentonite Chips 46-49'  
Filter Pack  
#3 Sand 49-72'  
Screened Interval  
Sch 40 0.020" Machine Slot PVC  
52-72'  
Bottom Plug  
Bentonite Chips 72-80'

| Depth (ft.) | Well Completion | PID (ppm) | Sample ID % Recovery | Blow Count Recovery | Graphic Log | USCS Class. | Description<br>(Color, Texture, Structure)<br>Geologic Descriptions are Based on the USCS.  |
|-------------|-----------------|-----------|----------------------|---------------------|-------------|-------------|---|
| 0           |                 |           |                      |                     |             |             | Bare Ground   |
| 0 - 10      |                 | 0.0       |                      |                     |             |             | GRAVELLY SILT WITH SAND; reddish brown (5YR 5/4); weak induration; 55% fines, no plasticity; 30% gravel, rounded; 5% medium sand; 10% fine sand; stiff; dry                             |
| 10 - 22     |                 | 0.0       |                      |                     |             | ML          | SILT WITH SAND; very dark grayish brown (10YR 3/2); weak induration; 80% fines, low plasticity; 5% medium sand; 15% fine sand; firm; damp<br><br>Trace coarse sand, trace gravel.       |
| 22 - 24     |                 | 0.0       |                      |                     |             | SW          | WELL-GRADED SAND; very dark brown (10YR 2/2); moderate induration; 50% coarse sand, subrounded; 25% medium sand, subrounded; 15% fine sand, subrounded; 10% gravel, rounded; dense; wet |

AEROJET Rev: 12/16/08 133317.GPJ SHAW.GDT 5/18/11

Continued Next Page



# Drilling Log

Monitoring Well  
**DB-3/BSW-1**

Page: 2 of 3

Project Aerojet ESTCP-NDMA Demo Owner Aerojet  
 Location Rancho Cordova, CA Proj. No. 133317

| Depth (ft.) | Well Completion | PID (ppm) | Sample ID % Recovery | Blow Count Recovery | Graphic Log | USCS Class. | Description<br>(Color, Texture, Structure)<br>Geologic Descriptions are Based on the USCS.   |
|-------------|-----------------|-----------|----------------------|---------------------|-------------|-------------|--|
| 24          |                 | 0.0       | 67%                  |                     |             |             |  |
| 26          |                 |           |                      |                     |             | SW          |  |
| 28          |                 |           |                      |                     |             |             |  |
| 30          |                 |           |                      |                     |             |             |  |
| 32          |                 |           |                      |                     |             | SM          | SILTY SAND; dark grayish brown (10YR 4/2); weak induration; 5% coarse sand, rounded to subrounded; 25% medium sand, rounded to subrounded; 50% fine sand, rounded to subrounded; 15% fines; 5% gravel; medium dense; wet   |
| 34          |                 | 0.0       | 67%                  |                     |             |             |  |
| 36          |                 |           |                      |                     |             | ML          | SANDY SILT; dark grayish brown (10YR 4/2); weak induration; 60% fines, low plasticity; trace coarse sand; 15% medium sand; 25% fine sand; stiff; moist   |
| 38          |                 |           |                      |                     |             |             |  |
| 40          |                 |           | 100%                 |                     |             | SW          | WELL-GRADED SAND WITH GRAVEL; very dark grayish brown (10YR 3/2); strong induration; 40% coarse sand, subrounded to angular; 20% medium sand, subrounded to angular; 15% fine sand, subrounded to angular; 25% gravel; wet |
| 42          |                 |           |                      |                     |             |             | SANDY SILT; dark yellowish brown (10YR 4/4); weak induration; 70% fines, low plasticity; 5% medium sand; 25% fine sand; firm; wet  |
| 44          |                 |           | 100%                 |                     |             |             | GRAVELLY SILT WITH SAND; brown (10YR 4/3); moderate induration; 55% fines, no plasticity to low plasticity; 25% gravel; trace coarse sand; 10% medium sand; 10% fine sand; very stiff; dry                                 |
| 46          |                 |           |                      |                     |             |             |  |
| 48          |                 |           |                      |                     |             | ML          |  |
| 50          |                 | 0.0       |                      |                     |             |             |  |
| 52          |                 |           | 100%                 |                     |             |             |  |
| 54          |                 |           |                      |                     |             |             |  |

AEROJET Rev: 12/16/08 133317.GPJ SHAW.GDT 5/18/11

Continued Next Page



# Drilling Log

Monitoring Well  
**DB-3/BSW-1**

Page: 3 of 3

Project Aerojet ESTCP-NDMA Demo Owner Aerojet  
 Location Rancho Cordova, CA Proj. No. 133317

| Depth (ft.) | Well Completion                     | PID (ppm) | Sample ID % Recovery | Blow Count Recovery  | Graphic Log   | USCS Class. | Description<br>(Color, Texture, Structure)<br>Geologic Descriptions are Based on the USCS. |  |    |  |   |
|-------------|-------------------------------------|-----------|----------------------|--|---|-------------|--|--|----|--|---|
| 56          |                                     | 0.0       | 0%                   |  |   | ML          | No recovery 55-65'   |  |    |  |   |
| 58          |                                     |           |                      |  |   |             |  |  |    |  |   |
| 60          |                                     |           |                      |  |   |             |  |  |    |  |   |
| 62          |                                     |           |                      |  |   |             |  |  |    |  |   |
| 64          |                                     |           |                      |  |   |             |  |  |    |  |   |
| 66          |                                     |           |                      |  |   |             |  |  | SW | WELL-GRADED SAND; very dark brown (10YR 2/2); moderate induration; 60% coarse sand, subrounded to subangular; 25% medium sand, subrounded to subangular; 15% fine sand, subrounded to subangular; dense; wet |   |
| 68          |                                     |           |                      |  |   |             |  |  |    |  |   |
| 70          |                                     |           |                      |  |   |             |  |  | GM | 100%   | SILTY GRAVEL; brown (10YR 4/3); weak induration; 60% gravel, rounded with large pieces of angular weathered slate; 25% fines; trace coarse sand; 5% medium sand; 10% fine sand; very dense; dry |
| 72          |                                     |           |                      |  |   |             |  |  |    |  |   |
| 74          |                                     |           |                      |  |   |             |  |  |    |  |   |
| 76          |                                     | ML        | 100%                 | SILT WITH SAND; dark yellowish brown (10YR 4/4); weak induration; 75% fines, low plasticity; 25% fine sand; stiff; moist |   |             |  |  |    |  |   |
| 78          |                                     |           |                      |  |   |             |  |  |    |  |   |
| 80          |                                     |           |                      |  | GRAVELLY SILT; brown (10YR 4/3); weak induration; 65% fines, low plasticity; 25% gravel; trace coarse sand; 5% medium sand; 5% fine sand; stiff; damp |             |  |  |    |  |   |
| 82          |                                     |           |                      |  |   |             |  |  |    |  |   |
| 84          | Boring terminated at planned depth. |           |                      |  |   |             |  |  |    |  |   |

AEROJET Rev: 12/16/08 133317.GPJ SHAW.GDT 5/18/11



# Drilling Log

Monitoring Well  
**DB-4/PMW-3**

Page: 1 of 3

Project Aerojet ESTCP-NDMA Demo Owner Aerojet  
 Location Rancho Cordova, CA Proj. No. 133317  
 Surface Elev. NA Total Hole Depth 68 ft. North NA East NA  
 Top of Casing NA Water Level Initial NA Static NA Diameter 6 in.  
 Screen: Dia 2 in. Length 5 ft. Type/Slot Sch 40 PVC/0.020 in.  
 Casing: Dia 2 in. Length 59 ft. Type Sch 40 Blank PVC  
 Fill Material See Comments Rig/Core CS500/Sonic  
 Drill Co. Cascade Drilling Method Sonic Core  
 Driller Jason Hernandez Log By Bryan Stempson Date 4/26/11 Permit # NA  
 Checked By \_\_\_\_\_ License No. \_\_\_\_\_

**COMMENTS**  
 0-38' was not sampled. Log was completed using 0-38' from DB-3/BSW-1.  
Annular Seal  
Bentonite-Cement Grout 0-53' Plug  
Bentonite Chips 53-56'  
Filter Pack  
#3 Sand 56-64'  
Screened Interval  
Sch 40 0.020" Machine Slot PVC 59-64'  
Bottom Plug  
Bentonite Chips 64-68'

| Depth (ft.) | Well Completion | PID (ppm) | Sample ID % Recovery | Blow Count Recovery | Graphic Log | USCS Class. | Description<br>(Color, Texture, Structure)<br>Geologic Descriptions are Based on the USCS.  |
|-------------|-----------------|-----------|----------------------|---------------------|-------------|-------------|---|
| 0           |                 |           |                      |                     |             |             | Bare Ground   |
| 0 - 10      |                 | 0.0       |                      |                     |             |             | GRAVELLY SILT WITH SAND; reddish brown (5YR 5/4); weak induration; 55% fines, no plasticity; 30% gravel, rounded; 5% medium sand; 10% fine sand; stiff; dry                             |
| 10 - 22     |                 | 0.0       |                      |                     |             | ML          | SILT WITH SAND; very dark grayish brown (10YR 3/2); weak induration; 80% fines, low plasticity; 5% medium sand; 15% fine sand; firm; damp<br><br>Trace coarse sand, trace gravel.       |
| 22 - 24     |                 | 0.0       |                      |                     |             | SW          | WELL-GRADED SAND; very dark brown (10YR 2/2); moderate induration; 50% coarse sand, subrounded; 25% medium sand, subrounded; 15% fine sand, subrounded; 10% gravel, rounded; dense; wet |

AEROJET Rev: 12/16/08 133317.GPJ SHAW.GDT 5/18/11

Continued Next Page



# Drilling Log

Monitoring Well  
**DB-4/PMW-3**

Page: 2 of 3

Project Aerojet ESTCP-NDMA Demo Owner Aerojet  
 Location Rancho Cordova, CA Proj. No. 133317

| Depth (ft.) | Well Completion | PID (ppm) | Sample ID % Recovery | Blow Count Recovery | Graphic Log | USCS Class. | Description<br>(Color, Texture, Structure)<br>Geologic Descriptions are Based on the USCS.   |
|-------------|-----------------|-----------|----------------------|---------------------|-------------|-------------|--|
| 24          |                 | 0.0       | 67%                  |                     |             |             |  |
| 26          |                 |           |                      |                     |             | SW          |  |
| 28          |                 |           |                      |                     |             |             |  |
| 30          |                 |           |                      |                     |             |             |  |
| 32          |                 |           |                      |                     |             | SM          | SILTY SAND; dark grayish brown (10YR 4/2); weak induration; 5% coarse sand, rounded to subrounded; 25% medium sand, rounded to subrounded; 50% fine sand, rounded to subrounded; 15% fines; 5% gravel; medium dense; wet |
| 34          |                 | 0.0       | 67%                  |                     |             |             |  |
| 36          |                 |           |                      |                     |             | ML          | SANDY SILT; dark grayish brown (10YR 4/2); weak induration; 60% fines, low plasticity; trace coarse sand; 15% medium sand; 25% fine sand; stiff; moist   |
| 38          |                 | 0.0       |                      |                     |             | SW          | WELL-GRADED SAND; very dark brown (10YR 2/2); moderate induration; 60% coarse sand, subrounded to subangular; 25% medium sand, subrounded to subangular; 15% fine sand, subrounded to subangular; dense; wet             |
| 40          |                 |           |                      |                     |             |             |  |
| 42          |                 |           | 100%                 |                     |             | ML          | GRAVELLY SILT; brown (10YR 4/3); moderate induration; 55% fines, no plasticity to low plasticity; 25% gravel, subrounded to rounded; trace coarse sand; 10% fine sand; very stiff; damp                                  |
| 44          |                 |           |                      |                     |             |             |  |
| 46          |                 |           |                      |                     |             |             |  |
| 48          |                 | 0.0       | 100%                 |                     |             | SM          | SILTY SAND; brown (10YR 4/3); weak induration; 10% coarse sand, subrounded to rounded; 20% medium sand, subrounded to rounded; 40% fine sand, subrounded to rounded; 30% fines; dense; wet                               |
| 50          |                 |           |                      |                     |             |             | Dark grayish brown (10YR 4/2), gravel increases to 10%, medium sand decreases to 15%, fine sand decreases to 35%.  |
| 52          |                 |           |                      |                     |             | GM          | SILTY GRAVEL; brown (10YR 4/3); moderate induration; 60% gravel, rounded; 30% fines, no plasticity to low plasticity; trace coarse sand; 5% medium sand; 5% fine sand  |
| 54          |                 |           |                      |                     |             | ML          | GRAVELLY SILT; dark grayish brown (10YR 4/2); moderate induration; 65% fines, no plasticity; 25% coarse gravel; trace coarse   |

AEROJET Rev: 12/16/08 133317.GPJ SHAW.GDT 5/18/11

Continued Next Page





# Drilling Log

Monitoring Well  
**DB-4/PMW-3**

Page: 3 of 3

Project Aerojet ESTCP-NDMA Demo Owner Aerojet  
 Location Rancho Cordova, CA Proj. No. 133317

| Depth (ft.) | Well Completion | PID (ppm) | Sample ID % Recovery | Blow Count Recovery | Graphic Log | USCS Class. | Description<br>(Color, Texture, Structure)<br>Geologic Descriptions are Based on the USCS.  |
|-------------|-----------------|-----------|----------------------|---------------------|-------------|-------------|---|
| 56          |                 |           | 100%                 |                     |             | ML          | sand; trace medium sand; 10% fine sand; very stiff; damp  |
| 58          |                 |           |                      |                     |             | ML          | SILT WITH SAND; dark yellowish brown (10YR 4/4); weak induration; 80% fines, no plasticity; 20% fine sand; stiff; damp  |
| 60          |                 |           |                      |                     |             | SW          | WELL-GRADED SAND WITH GRAVEL; black (10YR 2/1); moderate induration; 20% coarse sand, subrounded to subangular; 40% medium sand, subrounded to subangular; 25% fine sand, subrounded to subangular; 15% gravel, rounded; dense; wet |
| 62          |                 |           | 100%                 |                     |             | ML          | SANDY SILT; dark yellowish brown (10YR 4/4); weak induration; 70% fines, low plasticity; 30% fine sand; stiff; damp   |
| 64          |                 |           |                      |                     |             | ML          |   |
| 66          |                 |           |                      |                     |             |             |   |
| 68          |                 |           |                      |                     |             |             | Boring terminated at planned depth.   |
| 70          |                 |           |                      |                     |             |             |   |
| 72          |                 |           |                      |                     |             |             |   |
| 74          |                 |           |                      |                     |             |             |   |
| 76          |                 |           |                      |                     |             |             |   |
| 78          |                 |           |                      |                     |             |             |   |
| 80          |                 |           |                      |                     |             |             |   |
| 82          |                 |           |                      |                     |             |             |   |
| 84          |                 |           |                      |                     |             |             |   |

AEROJET Rev: 12/16/08 133317.GPJ SHAW.GDT 5/18/11



# Drilling Log

Monitoring Well  
**DB-5/PMW-2**

Page: 1 of 3

Project Aerojet ESTCP-NDMA Demo Owner Aerojet  
 Location Rancho Cordova, CA Proj. No. 133317  
 Surface Elev. NA Total Hole Depth 73 ft. North NA East NA  
 Top of Casing NA Water Level Initial NA Static NA Diameter 6 in.  
 Screen: Dia 2 in. Length 5 ft. Type/Slot Sch 40 PVC/0.020 in.  
 Casing: Dia 2 in. Length 60 ft. Type Sch 40 Blank PVC  
 Fill Material See Comments Rig/Core CS500/Sonic  
 Drill Co. Cascade Drilling Method Sonic Core  
 Driller Jason Hernandez Log By Bryan Stempson Date 4/27/11 Permit # NA  
 Checked By \_\_\_\_\_ License No. \_\_\_\_\_

COMMENTS  
 0-40' was not sampled. Log was completed using 0-40' from DB-3/BSW-1.  
 Annular Seal  
 Bentonite-Cement Grout 0-53.5' Plug  
 Bentonite Chips 53.5-56.5'  
 Filter Pack  
 #3 Sand 56.5-68'  
 Screened Interval  
 Sch 40 0.020" Machine Slot PVC 60-65'  
 Bottom Plug  
 Slough 68-73'

| Depth (ft.) | Well Completion | PID (ppm) | Sample ID % Recovery | Blow Count Recovery | Graphic Log | USCS Class. | Description<br>(Color, Texture, Structure)<br>Geologic Descriptions are Based on the USCS.  |
|-------------|-----------------|-----------|----------------------|---------------------|-------------|-------------|---|
| 0           |                 |           |                      |                     |             |             | Bare Ground   |
| 0 - 10      |                 | 0.0       |                      |                     |             |             | GRAVELLY SILT WITH SAND; reddish brown (5YR 5/4); weak induration; 55% fines, no plasticity; 30% gravel, rounded; 5% medium sand; 10% fine sand; stiff; dry                             |
| 10 - 22     |                 | 0.0       |                      |                     |             | ML          | SILT WITH SAND; very dark grayish brown (10YR 3/2); weak induration; 80% fines, low plasticity; 5% medium sand; 15% fine sand; firm; damp<br><br>Trace coarse sand, trace gravel.       |
| 22 - 24     |                 | 0.0       |                      |                     |             | SW          | WELL-GRADED SAND; very dark brown (10YR 2/2); moderate induration; 50% coarse sand, subrounded; 25% medium sand, subrounded; 15% fine sand, subrounded; 10% gravel, rounded; dense; wet |

AEROJET Rev: 12/16/08 133317.GPJ SHAW.GDT 5/18/11

Continued Next Page



# Drilling Log

Monitoring Well  
**DB-5/PMW-2**

Page: 2 of 3

Project Aerojet ESTCP-NDMA Demo Owner Aerojet  
 Location Rancho Cordova, CA Proj. No. 133317

| Depth (ft.) | Well Completion | PID (ppm) | Sample ID % Recovery | Blow Count Recovery | Graphic Log | USCS Class. | Description<br>(Color, Texture, Structure)<br>Geologic Descriptions are Based on the USCS.   |
|-------------|-----------------|-----------|----------------------|---------------------|-------------|-------------|--|
| 24          |                 | 0.0       | 67%                  |                     |             |             |  |
| 26          |                 |           |                      |                     |             | SW          |  |
| 28          |                 |           |                      |                     |             |             |  |
| 30          |                 |           |                      |                     |             |             |  |
| 32          |                 |           |                      |                     |             | SM          | SILTY SAND; dark grayish brown (10YR 4/2); weak induration; 5% coarse sand, rounded to subrounded; 25% medium sand, rounded to subrounded; 50% fine sand, rounded to subrounded; 15% fines; 5% gravel; medium dense; wet                       |
| 34          |                 | 0.0       | 67%                  |                     |             |             |  |
| 36          |                 |           |                      |                     |             | ML          | SANDY SILT; dark grayish brown (10YR 4/2); weak induration; 60% fines, low plasticity; trace coarse sand; 15% medium sand; 25% fine sand; stiff; moist   |
| 38          |                 |           |                      |                     |             |             |  |
| 40          |                 |           | 50%                  |                     |             | SW          | WELL-GRADED SAND WITH GRAVEL; very dark grayish brown (10YR 3/2); strong induration; 40% coarse sand, subrounded to angular; 20% medium sand, subrounded to angular; 15% fine sand, subrounded to angular; 25% gravel; wet                     |
| 42          |                 |           |                      |                     |             |             |  |
| 44          |                 |           |                      |                     |             | ML          | SILT WITH SAND; brown (10YR 4/3); weak induration; 75% fines, low plasticity; 10% medium sand; 15% fine sand; stiff; moist   |
| 46          |                 |           |                      |                     |             |             |  |
| 48          |                 | 0.0       |                      |                     |             | SM          | SILTY SAND; brown (10YR 4/3); weak induration; 10% coarse sand, rounded to subrounded; 20% medium sand, rounded to subrounded; 40% fine sand, rounded to subrounded; 30% fines; dense; wet   |
| 50          |                 |           |                      |                     |             | SW          | WELL-GRADED SAND WITH SILT AND GRAVEL; dark grayish brown (10YR 4/2); weak induration; 15% coarse sand, rounded to subrounded; 40% medium sand, rounded to subrounded; 20% fine sand, rounded to subrounded; 15% gravel; 10% fines; dense; wet |
| 52          |                 |           | 100%                 |                     |             |             |  |
| 54          |                 |           | 0%                   |                     |             | ML          | GRAVELLY SILT; dark grayish brown (10YR 4/2); moderate induration; 65% fines, no plasticity; 25% gravel; trace coarse sand; trace medium sand; 10% fine sand; very stiff; damp   |

AEROJET Rev: 12/16/08 133317.GPJ SHAW.GDT 5/18/11

Continued Next Page



# Drilling Log

Monitoring Well  
**DB-5/PMW-2**

Page: 3 of 3

Project Aerojet ESTCP-NDMA Demo Owner Aerojet  
 Location Rancho Cordova, CA Proj. No. 133317

| Depth (ft.) | Well Completion | PID (ppm) | Sample ID % Recovery | Blow Count Recovery | Graphic Log | USCS Class. | Description<br>(Color, Texture, Structure)<br>Geologic Descriptions are Based on the USCS.  |
|-------------|-----------------|-----------|----------------------|---------------------|-------------|-------------|---|
| 56          |                 |           | 100%                 |                     |             | ML          | WELL-GRADED GRAVEL WITH SAND; black (10YR 2/1); weak induration; 60% gravel, rounded; 15% coarse sand, subrounded; 15% medium sand, subrounded; 10% fine sand, subrounded; dense; wet |
| 58          |                 |           |                      |                     |             |             |   |
| 60          |                 |           |                      |                     |             |             |   |
| 62          |                 |           | 0%                   |                     |             | GW          |   |
| 64          |                 |           |                      |                     |             |             |   |
| 66          |                 |           |                      |                     |             |             |   |
| 68          |                 |           |                      |                     |             |             | SANDY SILT; dark yellowish brown (10YR 4/4); weak induration; 70% fines, low plasticity; 30% fine sand; stiff; damp   |
| 70          |                 |           | 100%                 |                     |             | ML          |   |
| 72          |                 |           |                      |                     |             |             | GRAVELLY SILT; brown (10YR 4/3); weak induration; 65% fines, low plasticity; 25% gravel; trace coarse sand; 5% medium sand; 5% fine sand; very stiff; damp                            |
| 74          |                 |           |                      |                     |             |             | Boring terminated at planned depth.   |
| 76          |                 |           |                      |                     |             |             |   |
| 78          |                 |           |                      |                     |             |             |   |
| 80          |                 |           |                      |                     |             |             |   |
| 82          |                 |           |                      |                     |             |             |   |
| 84          |                 |           |                      |                     |             |             |   |

AEROJET Rev: 12/16/08 133317.GPJ SHAW.GDT 5/18/11



# Drilling Log

Monitoring Well  
**DB-6/PMW-4**

Page: 1 of 3

Project Aerojet ESTCP-NDMA Demo Owner Aerojet  
 Location Rancho Cordova, CA Proj. No. 133317  
 Surface Elev. NA Total Hole Depth 71 ft. North NA East NA  
 Top of Casing NA Water Level Initial NA Static NA Diameter 6 in.  
 Screen: Dia 2 in. Length 5 ft. Type/Slot Sch 40 PVC/0.020 in.  
 Casing: Dia 2 in. Length 60 ft. Type Sch 40 Blank PVC  
 Fill Material See Comments Rig/Core CS500/Sonic  
 Drill Co. Cascade Drilling Method Sonic Core  
 Driller Jason Hernandez Log By Bryan Stempson Date 4/28/11 Permit # NA  
 Checked By \_\_\_\_\_ License No. \_\_\_\_\_

COMMENTS  
 0-40' was not sampled. Log was completed using 0-40' from DB-3/BSW-1.  
 Annular Seal  
 Bentonite-Cement Grout 0-54'  
 Plug  
 Bentonite Chips 54-57'  
 Filter Pack  
 #3 Sand 57-65'  
 Screened Interval  
 Sch 40 0.020" Machine Slot PVC 60-65'  
 Bottom Plug  
 Slough 65-71'

| Depth (ft.) | Well Completion | PID (ppm) | Sample ID % Recovery | Blow Count Recovery | Graphic Log | USCS Class. | Description<br>(Color, Texture, Structure)<br>Geologic Descriptions are Based on the USCS.  |
|-------------|-----------------|-----------|----------------------|---------------------|-------------|-------------|---|
| 0           |                 |           |                      |                     |             |             | Bare Ground   |
| 0 - 10      |                 | 0.0       |                      |                     |             |             | GRAVELLY SILT WITH SAND; reddish brown (5YR 5/4); weak induration; 55% fines, no plasticity; 30% gravel, rounded; 5% medium sand; 10% fine sand; stiff; dry                             |
| 10 - 22     |                 | 0.0       |                      |                     |             | ML          | SILT WITH SAND; very dark grayish brown (10YR 3/2); weak induration; 80% fines, low plasticity; 5% medium sand; 15% fine sand; firm; damp<br><br>Trace coarse sand, trace gravel.       |
| 22 - 24     |                 | 0.0       |                      |                     |             | SW          | WELL-GRADED SAND; very dark brown (10YR 2/2); moderate induration; 50% coarse sand, subrounded; 25% medium sand, subrounded; 15% fine sand, subrounded; 10% gravel, rounded; dense; wet |

AEROJET Rev: 12/16/08 133317.GPJ SHAW.GDT 5/18/11

Continued Next Page



# Drilling Log

Monitoring Well  
**DB-6/PMW-4**

Page: 2 of 3

Project Aerojet ESTCP-NDMA Demo Owner Aerojet  
 Location Rancho Cordova, CA Proj. No. 133317

| Depth (ft.) | Well Completion | PID (ppm) | Sample ID % Recovery | Blow Count Recovery | Graphic Log | USCS Class. | Description<br>(Color, Texture, Structure)<br>Geologic Descriptions are Based on the USCS.   |
|-------------|-----------------|-----------|----------------------|---------------------|-------------|-------------|--|
| 24          |                 | 0.0       | 67%                  |                     |             |             |  |
| 26          |                 |           |                      |                     |             | SW          |  |
| 28          |                 |           |                      |                     |             |             |  |
| 30          |                 |           |                      |                     |             |             |  |
| 32          |                 |           |                      |                     |             | SM          | SILTY SAND; dark grayish brown (10YR 4/2); weak induration; 5% coarse sand, rounded to subrounded; 25% medium sand, rounded to subrounded; 50% fine sand, rounded to subrounded; 15% fines; 5% gravel; medium dense; wet                 |
| 34          |                 | 0.0       | 67%                  |                     |             |             |  |
| 36          |                 |           |                      |                     |             | ML          | SANDY SILT; dark grayish brown (10YR 4/2); weak induration; 60% fines, low plasticity; trace coarse sand; 15% medium sand; 25% fine sand; stiff; moist   |
| 38          |                 |           |                      |                     |             |             |  |
| 40          |                 | 0.0       | 100%                 |                     |             | SW          | WELL-GRADED SAND WITH GRAVEL; very dark grayish brown (10YR 3/2); strong induration; 40% coarse sand, subrounded to angular; 20% medium sand, subrounded to angular; 15% fine sand, subrounded to angular; 25% gravel; wet               |
| 42          |                 |           |                      |                     |             | SM          | SILTY SAND; brown (10YR 4/3); weak induration; 10% coarse sand, rounded to subrounded; 20% medium sand, rounded to subrounded; 40% fine sand, rounded to subrounded; 30% fines; dense; wet   |
| 44          |                 |           | 100%                 |                     |             |             |  |
| 46          |                 |           |                      |                     |             |             |  |
| 48          |                 |           |                      |                     |             | ML          | SANDY SILT; brown (10YR 4/3); weak induration; 60% fines, no plasticity to low plasticity; 5% coarse sand; 15% medium sand; 20% fine sand; firm; wet   |
| 50          |                 |           | 100%                 |                     |             |             |  |
| 52          |                 |           |                      |                     |             | SW          | WELL-GRADED SAND WITH GRAVEL; black (10YR 2/1); moderate induration; 50% coarse sand, rounded to subrounded; 25% medium sand, rounded to subrounded; 10% fine sand, rounded to subrounded; 15% gravel, rounded to subrounded; dense; wet |
| 54          |                 |           | 100%                 |                     |             | ML          |  |

AEROJET Rev: 12/16/08 133317.GPJ SHAW.GDT 5/18/11

Continued Next Page



# Drilling Log

Monitoring Well  
**DB-6/PMW-4**

Page: 3 of 3

Project Aerojet ESTCP-NDMA Demo Owner Aerojet  
 Location Rancho Cordova, CA Proj. No. 133317

| Depth (ft.) | Well Completion | PID (ppm) | Sample ID % Recovery | Blow Count Recovery | Graphic Log | USCS Class. | Description<br>(Color, Texture, Structure)<br>Geologic Descriptions are Based on the USCS.   |
|-------------|-----------------|-----------|----------------------|---------------------|-------------|-------------|--|
| 56          |                 |           |                      |                     |             |             | GRAVELLY SILT; brown (10YR 4/3); moderate induration; 55% fines, low plasticity; 25% gravel; trace coarse sand; 10% medium sand; 10% fine sand; very stiff; damp                               |
| 58          |                 |           |                      |                     |             | ML          | SILT WITH SAND; dark yellowish brown (10YR 4/4); weak induration; 75% fines, low plasticity; 25% fine sand; stiff; damp  |
| 60          |                 |           | 0%                   |                     |             |             |  |
| 62          |                 |           |                      |                     |             |             |  |
| 64          |                 |           | 20%                  |                     |             | GW          | WELL-GRADED GRAVEL WITH SAND; black (10YR 2/1); weak induration; 75% gravel, subrounded to angular; 15% coarse sand, subrounded to angular; 10% medium sand, subrounded to angular; dense; wet |
| 66          |                 |           | 100%                 |                     |             |             |  |
| 68          |                 |           | 0%                   |                     |             |             |  |
| 70          |                 |           | 100%                 |                     |             | ML          | SILT WITH SAND; dark yellowish brown (10YR 4/4); weak induration; 75% fines, low plasticity; 25% fine sand; stiff; wet   |
| 72          |                 |           | 100%                 |                     |             |             | Boring terminated at planned depth.  |
| 74          |                 |           |                      |                     |             |             |  |
| 76          |                 |           |                      |                     |             |             |  |
| 78          |                 |           |                      |                     |             |             |  |
| 80          |                 |           |                      |                     |             |             |  |
| 82          |                 |           |                      |                     |             |             |  |
| 84          |                 |           |                      |                     |             |             |  |

AEROJET Rev: 12/16/08 133317.GPJ SHAW.GDT 5/18/11

File Original with DWR

State of California  
**Well Completion Report**

Refer to Instruction Pamphlet  
No. **e0183332**

Page 1 of 1  
 Owner's Well Number BMW-1  
 Date Work Began 07/17/2013 Date Work Ended 7/18/2013  
 Local Permit Agency Sacramento County  
 Permit Number NA Permit Date \_\_\_\_\_

DWR Use Only – Do Not Fill In

State Well Number/Site Number  
 Latitude \_\_\_\_\_ N Longitude \_\_\_\_\_ W  
 APN/TRS/Other \_\_\_\_\_

| Geologic Log  |  |
|---|--|
| Orientation <input type="radio"/> Vertical <input type="radio"/> Horizontal <input type="radio"/> Angle Specify _____ |  |
| Drilling Method _____ Drilling Fluid _____  |  |
| Depth from Surface  | Description                                |
| Feet to Feet  | Describe material, grain size, color, etc. |
|   | Destruction of Well                        |
|   |  |
|   |  |
|   |  |
|   |  |
|   |  |
|   |  |
|   |  |
|   |  |
|   |  |
|   |  |
|   |  |
|   |  |
|   |  |
|   |  |
|   |  |
|   |  |
|   |  |
|   |  |
|   |  |
|   |  |
|   |  |
|   |  |
|   |  |
|   |  |
|   |  |
|   |  |
|   |  |
|   |  |
| Total Depth of Boring <u>50</u> Feet  |  |
| Total Depth of Completed Well _____ Feet  |  |

| Well Owner  |  |
|---|--|
| Name <u>Aerojet Rocketdyne, Inc.</u>                        |  |
| Mailing Address <u>2001 Aerojet Rd</u>                      |  |
| City <u>Rancho Cordova</u> State <u>CA</u> Zip <u>95742</u> |  |

| Well Location   |  |
|---|--|
| Address <u>2100 Aerojet Rd</u>                                      |  |
| City <u>Rancho Cordova</u> County <u>Sacramento</u>                 |  |
| Latitude _____ N Longitude _____ W<br>Dec. Min. Sec. Dec. Min. Sec. |  |
| Datum _____ Dec. Lat. _____ Dec. Long. _____                        |  |
| APN Book _____ Page _____ Parcel _____                              |  |
| Township _____ Range _____ Section _____                            |  |

| Location Sketch                                       |      |
|---|------|
| (Sketch must be drawn by hand after form is printed.) |      |
| North   |      |
| West  | East |
| South   |      |

Illustrate or describe distance of well from roads, buildings, fences, rivers, etc. and attach a map. Use additional paper if necessary. Please be accurate and complete.

| Activity   |  |
|--|--|
| <input type="radio"/> New Well                         |  |
| <input type="radio"/> Modification/Repair              |  |
| <input type="radio"/> Deepen                           |  |
| <input type="radio"/> Other _____                      |  |
| <input checked="" type="radio"/> Destroy               |  |
| Describe procedures and materials under "GEOLOGIC LOG" |  |

| Planned Uses  |  |
|---|--|
| <input type="radio"/> Water Supply                                      |  |
| <input type="checkbox"/> Domestic <input type="checkbox"/> Public       |  |
| <input type="checkbox"/> Irrigation <input type="checkbox"/> Industrial |  |
| <input type="radio"/> Cathodic Protection                               |  |
| <input type="radio"/> Dewatering  |  |
| <input type="radio"/> Heat Exchange                                     |  |
| <input type="radio"/> Injection   |  |
| <input type="radio"/> Monitoring  |  |
| <input type="radio"/> Remediation                                       |  |
| <input type="radio"/> Sparging  |  |
| <input type="radio"/> Test Well   |  |
| <input type="radio"/> Vapor Extraction                                  |  |
| <input checked="" type="radio"/> Other <u>Destroy</u>                   |  |

| Water Level and Yield of Completed Well                 |  |  |  |
|---|--|--|--|
| Depth to first water _____ (Feet below surface)         |  |  |  |
| Depth to Static _____                                   |  |  |  |
| Water Level _____ (Feet) Date Measured _____            |  |  |  |
| Estimated Yield * _____ (GPM) Test Type _____           |  |  |  |
| Test Length _____ (Hours) Total Drawdown _____ (Feet)   |  |  |  |
| *May not be representative of a well's long term yield. |  |  |  |

| Casings            |                   |      |          |                |                  |             |                  |  |
|--------------------|-------------------|------|----------|----------------|------------------|-------------|------------------|--|
| Depth from Surface | Borehole Diameter | Type | Material | Wall Thickness | Outside Diameter | Screen Type | Slot Size if Any |  |
| Feet to Feet       | (Inches)          |      |          | (Inches)       | (Inches)         |             | (Inches)         |  |
|                    |                   |      |          |                |                  |             |                  |  |
|                    |                   |      |          |                |                  |             |                  |  |
|                    |                   |      |          |                |                  |             |                  |  |
|                    |                   |      |          |                |                  |             |                  |  |
|                    |                   |      |          |                |                  |             |                  |  |
|                    |                   |      |          |                |                  |             |                  |  |
|                    |                   |      |          |                |                  |             |                  |  |
|                    |                   |      |          |                |                  |             |                  |  |
|                    |                   |      |          |                |                  |             |                  |  |
|                    |                   |      |          |                |                  |             |                  |  |
|                    |                   |      |          |                |                  |             |                  |  |
|                    |                   |      |          |                |                  |             |                  |  |
|                    |                   |      |          |                |                  |             |                  |  |
|                    |                   |      |          |                |                  |             |                  |  |
|                    |                   |      |          |                |                  |             |                  |  |
|                    |                   |      |          |                |                  |             |                  |  |

| Annular Material   |    |        |                    |
|--------------------|----|--------|--------------------|
| Depth from Surface |    | Fill   | Description        |
| Feet to Feet       |    |        |                    |
| 0                  | 2  | Cement | Concrete           |
| 2                  | 50 | Cement | Portland / 5% Bent |
|                    |    |        |                    |
|                    |    |        |                    |
|                    |    |        |                    |
|                    |    |        |                    |
|                    |    |        |                    |
|                    |    |        |                    |
|                    |    |        |                    |
|                    |    |        |                    |
|                    |    |        |                    |
|                    |    |        |                    |
|                    |    |        |                    |
|                    |    |        |                    |
|                    |    |        |                    |
|                    |    |        |                    |
|                    |    |        |                    |
|                    |    |        |                    |

| Attachments   |  |
|---|--|
| <input type="checkbox"/> Geologic Log                 |  |
| <input type="checkbox"/> Well Construction Diagram    |  |
| <input type="checkbox"/> Geophysical Log(s)           |  |
| <input type="checkbox"/> Soil/Water Chemical Analyses |  |
| <input type="checkbox"/> Other _____                  |  |
| Attach additional information, if it exists.          |  |

| Certification Statement  |                  |               |                     |
|--|------------------|---------------|---------------------|
| I, the undersigned, certify that this report is complete and accurate to the best of my knowledge and belief |                  |               |                     |
| Name <u>Woodward Drilling Company, Inc.</u>  |                  |               |                     |
| Person, Firm or Corporation  |                  |               |                     |
| <u>550 River Road</u>  | <u>Rio Vista</u> | <u>CA</u>     | <u>94571</u>        |
| Address  |                  | State         | Zip                 |
| Signed <u><i>Conroy E. Woodward</i></u>  | <u>7/30/2013</u> | <u>710079</u> |                     |
| City   |                  | Date Signed   | C-57 License Number |
| C-57 Licensed Water Well Contractor  |                  |               |                     |







File Original with DWR

State of California
Well Completion Report

Refer to Instruction Pamphlet
No. e0183327

DWR Use Only - Do Not Fill In
State Well Number/Site Number
Latitude Longitude
APN/TRS/Other

Page 1 of 1

Owner's Well Number BW-3

Date Work Began 07/17/2013

Date Work Ended 7/18/2013

Local Permit Agency Sacramento County

Permit Number NA

Permit Date

Geologic Log
Orientation Vertical Horizontal Angle
Drilling Method Drilling Fluid

Table with 3 columns: Depth from Surface (Feet to Feet), Description, and Destruction of Well. Includes a grid for data entry.

Well Owner
Name Aerojet Rocketdyne, Inc.
Mailing Address 2001 Aerojet Rd
City Rancho Cordova State CA Zip 95742

Well Location
Address 2100 Aerojet Rd
City Rancho Cordova County Sacramento
Latitude Longitude
Datum Dec. Lat. Dec. Long.
APN Book Page Parcel
Township Range Section

Location Sketch
(Sketch must be drawn by hand after form is printed.)
North
West
East
South
Illustrate or describe distance of well from roads, buildings, fences, rivers, etc. and attach a map. Use additional paper if necessary. Please be accurate and complete.

Activity
New Well
Modification/Repair
Deepen
Other
Destroy
Describe procedures and materials under "GEOLOGIC LOG"

Planned Uses
Water Supply
Domestic Public
Irrigation Industrial
Cathodic Protection
Dewatering
Heat Exchange
Injection
Monitoring
Remediation
Sparging
Test Well
Vapor Extraction
Other Destroy

Water Level and Yield of Completed Well
Depth to first water (Feet below surface)
Depth to Static
Water Level (Feet) Date Measured
Estimated Yield \* (GPM) Test Type
Test Length (Hours) Total Drawdown (Feet)
\*May not be representative of a well's long term yield.

Casings table with columns: Depth from Surface, Borehole Diameter, Type, Material, Wall Thickness, Outside Diameter, Screen Type, Slot Size.

Annular Material table with columns: Depth from Surface, Fill, Description.

Attachments
Geologic Log
Well Construction Diagram
Geophysical Log(s)
Soil/Water Chemical Analyses
Other

Certification Statement
I, the undersigned, certify that this report is complete and accurate to the best of my knowledge and belief
Name Woodward Drilling Company, Inc.
Person, Firm or Corporation
550 River Road Rio Vista CA 94571
Address City State Zip
Signed Concina E. Woodward 7/30/2013 Date Signed 710079 C-57 License Number



File Original with DWR

State of California

Well Completion Report

Refer to Instruction Pamphlet No. e0183329

DWR Use Only - Do Not Fill In
State Well Number/Site Number
Latitude Longitude
APN/TRS/Other

Page 1 of 1

Owner's Well Number BW-5

Date Work Began 07/17/2013 Date Work Ended 7/18/2013

Local Permit Agency Sacramento County

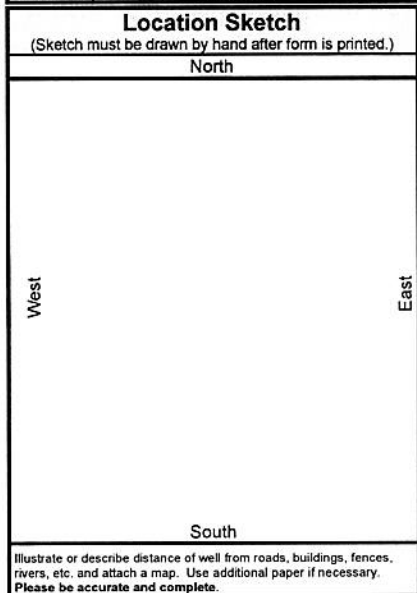
Permit Number NA Permit Date

Geologic Log
Orientation Vertical Horizontal Angle Specify
Drilling Method Drilling Fluid

Table with columns: Depth from Surface (Feet to Feet), Description (Describe material, grain size, color, etc). Entry: Destruction of Well

Well Owner
Name Aerojet Rocketdyne, Inc.
Mailing Address 2001 Aerojet Rd
City Rancho Cordova State CA Zip 95742

Well Location
Address 2100 Aerojet Rd
City Rancho Cordova County Sacramento
Latitude Longitude
Datum Dec. Lat. Dec. Long.
APN Book Page Parcel
Township Range Section



- Activity
New Well
Modification/Repair
Deepen
Other
Destroy (checked)
Describe procedures and materials under "GEOLOGIC LOG"

- Planned Uses
Water Supply (Domestic, Public, Irrigation, Industrial)
Cathodic Protection
Dewatering
Heat Exchange
Injection
Monitoring
Remediation
Sparging
Test Well
Vapor Extraction
Other Destroy (checked)

Water Level and Yield of Completed Well
Depth to first water (Feet below surface)
Depth to Static
Water Level (Feet) Date Measured
Estimated Yield \* (GPM) Test Type
Test Length (Hours) Total Drawdown (Feet)
\*May not be representative of a well's long term yield.

Casings table with columns: Depth from Surface (Feet to Feet), Borehole Diameter (Inches), Type, Material, Wall Thickness (Inches), Outside Diameter (Inches), Screen Type, Slot Size if Any (Inches)

Annular Material table with columns: Depth from Surface (Feet to Feet), Fill, Description
Entry: 0-2 ft Cement Concrete; 2-68 ft Cement Portland / 5% Bentonite

- Attachments
Geologic Log
Well Construction Diagram
Geophysical Log(s)
Soil/Water Chemical Analyses
Other

Certification Statement
I, the undersigned, certify that this report is complete and accurate to the best of my knowledge and belief
Name Woodward Drilling Company, Inc.
Address 550 River Road City Rio Vista State CA Zip 94571
Signed [Signature] Date Signed 7/30/2013 C-57 License Number 710079

File Original with DWR

# State of California Well Completion Report

Page 1 of 1

Owner's Well Number BW-6

Refer to Instruction Pamphlet  
No. **e0183330**

Date Work Began 07/17/2013 Date Work Ended 7/18/2013

Local Permit Agency Sacramento County

Permit Number NA Permit Date \_\_\_\_\_

DWR Use Only - Do Not Fill In

|                               |  |  |  |   |           |  |  |   |
|-------------------------------|--|--|--|---|-----------|--|--|---|
| State Well Number/Site Number |  |  |  |   |           |  |  |   |
| Latitude                      |  |  |  | N | Longitude |  |  | W |
| APN/TRS/Other                 |  |  |  |   |           |  |  |   |

### Geologic Log

Orientation  Vertical  Horizontal  Angle Specify \_\_\_\_\_

Drilling Method \_\_\_\_\_ Drilling Fluid \_\_\_\_\_

| Depth from Surface |         | Description                               |
|--------------------|---------|---|
| Feet               | to Feet | Describe material, grain size, color, etc |

| Depth from Surface            |         | Description                               |
|-------------------------------|---------|---|
| Feet                          | to Feet | Describe material, grain size, color, etc |
| Destruction of Well           |         |   |
|                               |         |   |
|                               |         |   |
|                               |         |   |
|                               |         |   |
|                               |         |   |
|                               |         |   |
|                               |         |   |
|                               |         |   |
|                               |         |   |
|                               |         |   |
|                               |         |   |
|                               |         |   |
|                               |         |   |
|                               |         |   |
|                               |         |   |
|                               |         |   |
|                               |         |   |
|                               |         |   |
|                               |         |   |
| Total Depth of Boring         |         | <u>76</u> Feet                            |
| Total Depth of Completed Well |         | _____ Feet                                |

### Well Owner

Name Aerojet Rocketdyne, Inc.

Mailing Address 2001 Aerojet Rd

City Rancho Cordova State CA Zip 95742

### Well Location

Address 2100 Aerojet Rd

City Rancho Cordova County Sacramento

Latitude \_\_\_\_\_ N Longitude \_\_\_\_\_ W

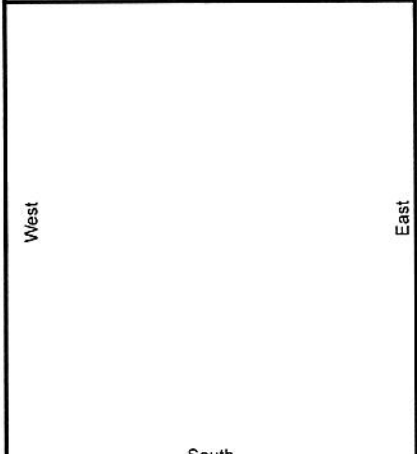
Datum \_\_\_\_\_ Dec. Lat. \_\_\_\_\_ Dec. Long. \_\_\_\_\_

APN Book \_\_\_\_\_ Page \_\_\_\_\_ Parcel \_\_\_\_\_

Township \_\_\_\_\_ Range \_\_\_\_\_ Section \_\_\_\_\_

### Location Sketch

(Sketch must be drawn by hand after form is printed.)



Illustrate or describe distance of well from roads, buildings, fences, rivers, etc. and attach a map. Use additional paper if necessary. Please be accurate and complete.

### Activity

- New Well
- Modification/Repair
  - Deepen
  - Other \_\_\_\_\_
- Destroy  
Describe procedures and materials under 'GEOLOGIC LOG'

### Planned Uses

- Water Supply
  - Domestic  Public
  - Irrigation  Industrial
- Cathodic Protection
- Dewatering
- Heat Exchange
- Injection
- Monitoring
- Remediation
- Sparging
- Test Well
- Vapor Extraction
- Other Destroy

### Water Level and Yield of Completed Well

Depth to first water \_\_\_\_\_ (Feet below surface)

Depth to Static \_\_\_\_\_

Water Level \_\_\_\_\_ (Feet) Date Measured \_\_\_\_\_

Estimated Yield \* \_\_\_\_\_ (GPM) Test Type \_\_\_\_\_

Test Length \_\_\_\_\_ (Hours) Total Drawdown \_\_\_\_\_ (Feet)

\*May not be representative of a well's long term yield.

### Casings

| Depth from Surface | Borehole Diameter | Type | Material | Wall Thickness | Outside Diameter | Screen Type | Slot Size       |
|--------------------|-------------------|------|----------|----------------|------------------|-------------|-----------------|
| Feet to Feet       | (Inches)          |      |          | (Inches)       | (Inches)         |             | if Any (Inches) |
|                    |                   |      |          |                |                  |             |                 |
|                    |                   |      |          |                |                  |             |                 |
|                    |                   |      |          |                |                  |             |                 |
|                    |                   |      |          |                |                  |             |                 |
|                    |                   |      |          |                |                  |             |                 |
|                    |                   |      |          |                |                  |             |                 |
|                    |                   |      |          |                |                  |             |                 |

### Annular Material

| Depth from Surface | Fill   | Description             |
|--------------------|--------|-------------------------|
| Feet to Feet       |        |                         |
| 0 - 2              | Cement | Concrete                |
| 2 - 76             | Cement | Portland / 5% Bentonite |
|                    |        |                         |
|                    |        |                         |
|                    |        |                         |
|                    |        |                         |

### Attachments

- Geologic Log
- Well Construction Diagram
- Geophysical Log(s)
- Soil/Water Chemical Analyses
- Other \_\_\_\_\_

Attach additional information, if it exists.

### Certification Statement

I, the undersigned, certify that this report is complete and accurate to the best of my knowledge and belief

Name Woodward Drilling Company, Inc.

Person, Firm or Corporation

550 River Road Rio Vista CA 94571

Signed Conroy E. Woodward 7/30/2013 State CA Zip 95709

C-57 Licensed Water Well Contractor Date Signed C-57 License Number



\*The free Adobe Reader may be used to view and complete this form. However, software must be purchased to complete, save, and reuse a saved form.

File Original with DWR

State of California

**Well Completion Report**

Refer to Instruction Pamphlet No. e0183333

| DWR Use Only – Do Not Fill In |             |
|-------------------------------|-------------|
| State Well Number/Site Number |             |
| N Latitude                    | W Longitude |
| APN/TRS/Other                 |             |

Page 1 of 1

Owner's Well Number PMW-1

Date Work Began 07/17/2013

Date Work Ended 7/18/2013

Local Permit Agency Sacramento County

Permit Number NA

Permit Date \_\_\_\_\_

| Geologic Log                             |   |
|--|---|
| Orientation                              | <input type="radio"/> Vertical <input type="radio"/> Horizontal <input type="radio"/> Angle Specify _____ |
| Drilling Method                          | _____ Drilling Fluid _____  |
| Depth from Surface                       | Description   |
| Feet to Feet                             | Describe material, grain size, color, etc   |
|  | Destruction of Well   |
|  |   |
|  |   |
|  |   |
|  |   |
|  |   |
|  |   |
|  |   |
|  |   |
|  |   |
|  |   |
|  |   |
|  |   |
|  |   |
|  |   |
|  |   |
| Total Depth of Boring <u>65</u> Feet     |   |
| Total Depth of Completed Well _____ Feet |   |

| Well Owner                             |                                  |
|--|----------------------------------|
| Name <u>Aerojet Rocketdyne, Inc.</u>   |                                  |
| Mailing Address <u>2001 Aerojet Rd</u> |                                  |
| City <u>Rancho Cordova</u>             | State <u>CA</u> Zip <u>95742</u> |
| Well Location                          |                                  |
| Address <u>2100 Aerojet Rd</u>         |                                  |
| City <u>Rancho Cordova</u>             | County <u>Sacramento</u>         |
| Latitude _____ N                       | Longitude _____ W                |
| Dea. _____ Min. _____ Sec. _____       | Dea. _____ Min. _____ Sec. _____ |
| Datum _____                            | Dec. Lat. _____ Dec. Long. _____ |
| APN Book _____ Page _____              | Parcel _____                     |
| Township _____ Range _____             | Section _____                    |

| Location Sketch  | Activity  |      |      |       |   |
|--|---|------|------|-------|---|
| (Sketch must be drawn by hand after form is printed.)  | <input type="radio"/> New Well<br><input type="radio"/> Modification/Repair<br><input type="radio"/> Deepen<br><input type="radio"/> Other _____<br><input checked="" type="radio"/> Destroy<br><small>Describe procedures and materials under "GEOLOGIC LOG"</small> |      |      |       |   |
| <table border="1"> <tr><td>North</td></tr> <tr><td>West</td></tr> <tr><td>East</td></tr> <tr><td>South</td></tr> </table>  | North   | West | East | South | <b>Planned Uses</b><br><input type="radio"/> Water Supply<br><input type="checkbox"/> Domestic <input type="checkbox"/> Public<br><input type="checkbox"/> Irrigation <input type="checkbox"/> Industrial<br><input type="radio"/> Cathodic Protection<br><input type="radio"/> Dewatering<br><input type="radio"/> Heat Exchange<br><input type="radio"/> Injection<br><input type="radio"/> Monitoring<br><input type="radio"/> Remediation<br><input type="radio"/> Sparging<br><input type="radio"/> Test Well<br><input type="radio"/> Vapor Extraction<br><input checked="" type="radio"/> Other <u>Destroy</u> |
|  | North   |      |      |       |   |
| West   |   |      |      |       |   |
| East   |   |      |      |       |   |
| South  |   |      |      |       |   |
| <small>Illustrate or describe distance of well from roads, buildings, fences, rivers, etc. and attach a map. Use additional paper if necessary. Please be accurate and complete.</small> |   |      |      |       |   |

| Water Level and Yield of Completed Well                 |                             |
|---|-----------------------------|
| Depth to first water _____ (Feet below surface)         |                             |
| Depth to Static _____                                   |                             |
| Water Level _____ (Feet)                                | Date Measured _____         |
| Estimated Yield * _____ (GPM)                           | Test Type _____             |
| Test Length _____ (Hours)                               | Total Drawdown _____ (Feet) |
| *May not be representative of a well's long term yield. |                             |

| Casings            |                   |      |          |                |                  | Annular Material |                  |                    |      |                                |
|--------------------|-------------------|------|----------|----------------|------------------|------------------|------------------|--------------------|------|--------------------------------|
| Depth from Surface | Borehole Diameter | Type | Material | Wall Thickness | Outside Diameter | Screen Type      | Slot Size if Any | Depth from Surface | Fill | Description                    |
| Feet to Feet       | (Inches)          |      |          | (Inches)       | (Inches)         |                  | (Inches)         | Feet to Feet       |      |                                |
|                    |                   |      |          |                |                  |                  |                  | 0                  | 2    | Cement Concrete                |
|                    |                   |      |          |                |                  |                  |                  | 2                  | 65   | Cement Portland / 5% Bentonite |

| Attachments   |
|---|
| <input type="checkbox"/> Geologic Log<br><input type="checkbox"/> Well Construction Diagram<br><input type="checkbox"/> Geophysical Log(s)<br><input type="checkbox"/> Soil/Water Chemical Analyses<br><input type="checkbox"/> Other _____ |
| <small>Attach additional information, if it exists.</small>   |

| Certification Statement  |                  |               |                     |
|--|------------------|---------------|---------------------|
| I, the undersigned, certify that this report is complete and accurate to the best of my knowledge and belief |                  |               |                     |
| Name <u>Woodward Drilling Company, Inc.</u>  |                  |               |                     |
| Person, Firm or Corporation  |                  |               |                     |
| <u>550 River Road</u>  | <u>Rio Vista</u> | <u>CA</u>     | <u>94571</u>        |
| Address  |                  | City          | State Zip           |
| Signed <u><i>Conroy E. Woodward</i></u>  | <u>7/30/2013</u> | <u>710079</u> |                     |
| C-57 Licensed Water Well Contractor  |                  | Date Signed   | C-57 License Number |





\*The free Adobe Reader may be used to view and complete this form. However, software must be purchased to complete, save, and reuse a saved form.

File Original with DWR

State of California  
**Well Completion Report**

Refer to Instruction Pamphlet  
No. e0183335

| DWR Use Only - Do Not Fill In |  |           |  |
|-------------------------------|--|-----------|--|
| State Well Number/Site Number |  |           |  |
| Latitude                      |  | Longitude |  |
| APN/TRS/Other                 |  |           |  |

Page 1 of 1  
Owner's Well Number PMW-3  
Date Work Began 07/17/2013 Date Work Ended 7/18/2013  
Local Permit Agency Sacramento County  
Permit Number NA Permit Date \_\_\_\_\_

| Geologic Log  |   |
|---|---|
| Orientation <input type="radio"/> Vertical <input type="radio"/> Horizontal <input type="radio"/> Angle Specify _____ |   |
| Drilling Method _____ Drilling Fluid _____  |   |
| Depth from Surface  | Description                               |
| Feet to Feet  | Describe material, grain size, color, etc |
|   | Destruction of Well                       |
|   |   |
|   |   |
|   |   |
|   |   |
|   |   |
|   |   |
|   |   |
|   |   |
|   |   |
|   |   |
|   |   |
|   |   |
|   |   |
|   |   |
|   |   |
|   |   |
|   |   |
|   |   |
|   |   |
|   |   |
|   |   |
|   |   |
|   |   |
|   |   |
| Total Depth of Boring   | <u>64</u> Feet                            |
| Total Depth of Completed Well   | _____ Feet                                |

| Well Owner   |  |
|--|--|
| Name <u>Aerojet Rocketdyne, Inc.</u>   |  |
| Mailing Address <u>2001 Aerojet Rd</u>   |  |
| City <u>Rancho Cordova</u> State <u>CA</u> Zip <u>95742</u>  |  |
| Well Location  |  |
| Address <u>2100 Aerojet Rd</u>   |  |
| City <u>Rancho Cordova</u> County <u>Sacramento</u>  |  |
| Latitude _____ N Longitude _____ W   |  |
| Datum _____ Dec. Lat. _____ Dec. Long. _____   |  |
| APN Book _____ Page _____ Parcel _____   |  |
| Township _____ Range _____ Section _____   |  |
| Location Sketch  |  |
| (Sketch must be drawn by hand after form is printed.)  |  |
| North  |  |
|  |  |
| South  |  |
| Illustrate or describe distance of well from roads, buildings, fences, rivers, etc. and attach a map. Use additional paper if necessary. Please be accurate and complete.  |  |
| Activity   |  |
| <input type="radio"/> New Well<br><input type="radio"/> Modification/Repair<br><input type="radio"/> Deepen<br><input type="radio"/> Other _____<br><input checked="" type="radio"/> Destroy<br><small>Describe procedures and materials under "GEOLOGIC LOG"</small>  |  |
| Planned Uses   |  |
| <input type="radio"/> Water Supply<br><input type="checkbox"/> Domestic <input type="checkbox"/> Public<br><input type="checkbox"/> Irrigation <input type="checkbox"/> Industrial<br><input type="radio"/> Cathodic Protection<br><input type="radio"/> Dewatering<br><input type="radio"/> Heat Exchange<br><input type="radio"/> Injection<br><input type="radio"/> Monitoring<br><input type="radio"/> Remediation<br><input type="radio"/> Sparging<br><input type="radio"/> Test Well<br><input type="radio"/> Vapor Extraction<br><input checked="" type="radio"/> Other <u>Destroy</u> |  |
| Water Level and Yield of Completed Well  |  |
| Depth to first water _____ (Feet below surface)  |  |
| Depth to Static _____  |  |
| Water Level _____ (Feet) Date Measured _____   |  |
| Estimated Yield * _____ (GPM) Test Type _____  |  |
| Test Length _____ (Hours) Total Drawdown _____ (Feet)  |  |
| *May not be representative of a well's long term yield.  |  |

| Casings            |                   |      |          |                |                  |             |                 |
|--------------------|-------------------|------|----------|----------------|------------------|-------------|-----------------|
| Depth from Surface | Borehole Diameter | Type | Material | Wall Thickness | Outside Diameter | Screen Type | Slot Size       |
| Feet to Feet       | (Inches)          |      |          | (Inches)       | (Inches)         |             | if Any (Inches) |
|                    |                   |      |          |                |                  |             |                 |
|                    |                   |      |          |                |                  |             |                 |
|                    |                   |      |          |                |                  |             |                 |
|                    |                   |      |          |                |                  |             |                 |
|                    |                   |      |          |                |                  |             |                 |
|                    |                   |      |          |                |                  |             |                 |
|                    |                   |      |          |                |                  |             |                 |
|                    |                   |      |          |                |                  |             |                 |
|                    |                   |      |          |                |                  |             |                 |

| Annular Material   |      |             |                         |
|--------------------|------|-------------|-------------------------|
| Depth from Surface | Fill | Description |                         |
| Feet to Feet       |      |             |                         |
| 0                  | 2    | Cement      | Concrete                |
| 2                  | 64   | Cement      | Portland / 5% Bentonite |
|                    |      |             |                         |
|                    |      |             |                         |
|                    |      |             |                         |
|                    |      |             |                         |
|                    |      |             |                         |
|                    |      |             |                         |
|                    |      |             |                         |

| Attachments   |
|---|
| <input type="checkbox"/> Geologic Log<br><input type="checkbox"/> Well Construction Diagram<br><input type="checkbox"/> Geophysical Log(s)<br><input type="checkbox"/> Soil/Water Chemical Analyses<br><input type="checkbox"/> Other _____ |
| <small>Attach additional information, if it exists.</small>   |

| Certification Statement  |                            |                                    |                    |
|--|----------------------------|------------------------------------|--------------------|
| I, the undersigned, certify that this report is complete and accurate to the best of my knowledge and belief |                            |                                    |                    |
| Name <u>Woodward Drilling Company, Inc.</u>  |                            |                                    |                    |
| <small>Person, Firm or Corporation</small>   |                            |                                    |                    |
| <u>550 River Road</u>  | <u>Rio Vista</u>           | <u>CA</u>                          | <u>94571</u>       |
| <small>Address</small>   | <small>City</small>        | <small>State</small>               | <small>Zip</small> |
| Signed <u>Concetta E. Woodward</u>   | <u>7/30/2013</u>           | <u>710079</u>                      | <u> </u>           |
| <small>C-57 Licensed Water Well Contractor</small>   | <small>Date Signed</small> | <small>C-57 License Number</small> | <small> </small>   |

File Original with DWR

State of California  
**Well Completion Report**

Refer to Instruction Pamphlet  
 No. e0183336

Page 1 of 1

Owner's Well Number PMW-4

Date Work Began 07/17/2013

Date Work Ended 7/18/2013

Local Permit Agency Sacramento County

Permit Number NA

Permit Date \_\_\_\_\_

| DWR Use Only – Do Not Fill In |           |
|-------------------------------|-----------|
| State Well Number/Site Number |           |
| Latitude                      | Longitude |
| APN/TRS/Other                 |           |

**Geologic Log**

Orientation  Vertical  Horizontal  Angle Specify \_\_\_\_\_

Drilling Method \_\_\_\_\_ Drilling Fluid \_\_\_\_\_

| Depth from Surface | Description                               |
|--------------------|---|
| Feet to Feet       | Describe material, grain size, color, etc |
|                    | Destruction of Well                       |
|                    |   |
|                    |   |
|                    |   |
|                    |   |
|                    |   |
|                    |   |
|                    |   |
|                    |   |
|                    |   |
|                    |   |
|                    |   |
|                    |   |
|                    |   |
|                    |   |
|                    |   |
|                    |   |
|                    |   |
|                    |   |
|                    |   |
|                    |   |
|                    |   |
|                    |   |
|                    |   |
|                    |   |
|                    |   |

**Well Owner**

Name Aerojet Rocketdyne, Inc.

Mailing Address 2001 Aerojet Rd

City Rancho Cordova State CA Zip 95742

**Well Location**

Address 2100 Aerojet Rd

City Rancho Cordova County Sacramento

Latitude \_\_\_\_\_ N Longitude \_\_\_\_\_ W  
Dec. Min. Sec. Dec. Min. Sec.

Datum \_\_\_\_\_ Dec. Lat. \_\_\_\_\_ Dec. Long. \_\_\_\_\_

APN Book \_\_\_\_\_ Page \_\_\_\_\_ Parcel \_\_\_\_\_

Township \_\_\_\_\_ Range \_\_\_\_\_ Section \_\_\_\_\_

**Location Sketch**  
 (Sketch must be drawn by hand after form is printed.)

North

West East

South

Illustrate or describe distance of well from roads, buildings, fences, rivers, etc. and attach a map. Use additional paper if necessary. Please be accurate and complete.

**Activity**

New Well

Modification/Repair

Deepen

Other \_\_\_\_\_

Destroy  
Describe procedures and materials under "GEOLOGIC LOG"

**Planned Uses**

Water Supply

Domestic  Public

Irrigation  Industrial

Cathodic Protection

Dewatering

Heat Exchange

Injection

Monitoring

Remediation

Sparging

Test Well

Vapor Extraction

Other Destroy

|                               |           |      |
|-------------------------------|-----------|------|
| Total Depth of Boring         | <u>65</u> | Feet |
| Total Depth of Completed Well | _____     | Feet |

**Water Level and Yield of Completed Well**

Depth to first water \_\_\_\_\_ (Feet below surface)

Depth to Static \_\_\_\_\_

Water Level \_\_\_\_\_ (Feet) Date Measured \_\_\_\_\_

Estimated Yield \* \_\_\_\_\_ (GPM) Test Type \_\_\_\_\_

Test Length \_\_\_\_\_ (Hours) Total Drawdown \_\_\_\_\_ (Feet)

\*May not be representative of a well's long term yield.

| Casings            |                   |      |          |                |                  |             |                 |
|--------------------|-------------------|------|----------|----------------|------------------|-------------|-----------------|
| Depth from Surface | Borehole Diameter | Type | Material | Wall Thickness | Outside Diameter | Screen Type | Slot Size       |
| Feet to Feet       | (Inches)          |      |          | (Inches)       | (Inches)         |             | if Any (Inches) |
|                    |                   |      |          |                |                  |             |                 |
|                    |                   |      |          |                |                  |             |                 |
|                    |                   |      |          |                |                  |             |                 |
|                    |                   |      |          |                |                  |             |                 |
|                    |                   |      |          |                |                  |             |                 |

| Annular Material   |      |             |                     |
|--------------------|------|-------------|---------------------|
| Depth from Surface | Fill | Description |                     |
| Feet to Feet       |      |             |                     |
| 0                  | 2    | Cement      | Concrete            |
| 2                  | 65   | Cement      | Portland / 5% Bents |
|                    |      |             |                     |
|                    |      |             |                     |

**Attachments**

Geologic Log

Well Construction Diagram

Geophysical Log(s)

Soil/Water Chemical Analyses

Other \_\_\_\_\_

Attach additional information, if it exists.

**Certification Statement**

I, the undersigned, certify that this report is complete and accurate to the best of my knowledge and belief

Name Woodward Drilling Company, Inc.

Person, Firm or Corporation

550 River Road Address Rio Vista City CA State 94571 Zip

Signed Concra G. Woodward Date Signed 7/30/2013 C-57 License Number 710079

C-57 Licensed Water Well Contractor



