

CO₂ SPARGING PHASE 3 FULL- SCALE IMPLEMENTATION AND MONITORING REPORT

LCP CHEMICALS SITE, BRUNSWICK, GA

Prepared for Honeywell

Prepared by:

Mutch Associates, LLC

360 Darlington Avenue

Ramsey, NJ 07446

In collaboration with:

Parsons

3577 Parkway Lane, Suite 100

Norcross, GA 30309

July 14, 2016

EXECUTIVE SUMMARY

In-situ carbon dioxide (CO₂) sparging was designed and implemented to treat a subsurface caustic brine pool (CBP) formed as a result of releases from historical production of industrial chemicals at the LCP Chemicals Site, Brunswick, GA (Site). The CBP is being addressed under an Administrative Settlement Agreement and Order on Consent (AOC), which was entered into between Honeywell and EPA on April 18, 2007. The remedial action objectives (RAOs) that are defined in the AOC include: 1) reducing the pH of the CBP to between 10 and 10.5 and 2) reducing the density of the CBP.

This report describes the implementation and monitoring results related to Phase 3 of CO₂ sparging and summarizes the effect of all three phases of sparging on groundwater quality within the deep Satilla aquifer beneath the Site. These three CO₂ sparging phases were as follows:

- Phase 1 conducted between October 2013 and February 2014;
- Phase 2 conducted between October 2014 and April 2015; and
- Phase 3 conducted between October 2015 and May 2016.

The technical objectives of Phase 3 sparging were to build upon the success of the first two phases and achieve compliance with the RAOs within the deep Satilla aquifer. Specifically, Phase 3 addressed two areas within the Phase 1 footprint and completed treatment in the southern area of the Site.

Sparging Activity

A total of 64 sparge wells were installed at the Site during Phase 3, bringing the total number of sparge wells to 209. Phase 3 sparging was initiated on October 10, 2015 and continued through April 7, 2016. After the post-sparge sampling event, remaining CO₂ in storage was sparged into select sparge wells from May 11, 2016 through May 17, 2016. As was performed in Phases 1 and 2, the target mass for each sparge well was calculated from interpolated groundwater alkalinity mappings. The targeted CO₂ per sparge well varied from 8,000 to 36,000 lb. All Phase 3 sparge wells received their target mass.

Reduction in pH

Prior to the start of Phase 1 CO₂ sparging, the average pH of the CBP was 11.3. After Phase 3, nearly all (28 out of 30; 93%) of deep Satilla monitoring points (monitoring wells and extraction wells) had a pH of less than 10.5. Most of these monitoring points had pH less than 7.5 (24 out of 30; 80%). The mean pH in the deep Satilla monitoring points decreased from 11.32 (2011-2012) to 7.11 as a result of CO₂ sparging. The median pH decreased from 11.44 to 6.57.

Reduction in Specific Gravity

The effect of CO₂ sparging on the density of groundwater was evaluated by two methods. First, pre-Phase 1 and post-Phase 3 measurements of groundwater specific gravity (SG) were compared for deep Satilla monitoring points where data was available. Second, pre-Phase 1 and post-Phase 3 SG was computed for all deep Satilla monitoring points using measured total dissolved solids (TDS) concentrations. In both cases, the SG decreased from pre-Phase 1 baseline conditions. Computed SG decreased in 20 out of 30 deep Satilla monitoring locations. The decrease in median computed SG was significant at the 95% confidence level, supporting the conclusion that CO₂ sparging decreased the density of the CBP. The decrease in SG was largely the result of the reductions in dissolved silica concentrations when the pH was decreased to circumneutral.

Reduction in Mercury (Hg) Concentrations

Prior to the start of CO₂ sparging, the total mercury concentration in the CBP ranged from 35.7 to 2,530 µg/L, with a mean of 270 µg/L and median of 128 µg/L. By the end of Phase 3, almost every monitoring point (28 out of 30) in the deep Satilla had lower total Hg when compared to pre-sparg levels. The majority (23 out of 30; 77%) of monitoring points had total Hg concentrations less than 20 µg/L. About one-third of all monitoring points (11 out of 30; 37%) had Hg concentrations less than 2.0 µg/L. At the end of Phase 3, the average total Hg concentration decreased 87% from 270 to 36 µg/L. The median Hg concentration decreased 97% from 128 to 4 µg/L.

Conclusions

In summary, for the Phase 3 sparging:

- Nearly all (28 out of 30; 93%) of the deep Satilla monitoring and extraction wells had a pH of less than 10.5. Most of these monitoring points had pH less than 7.5 (23 out of 30; 77%). In the southern area, the majority of post-Phase 3 discrete groundwater samples collected by Geoprobe from the base of the Satilla aquifer were less than 10.5; and
- The majority (23 out of 30; 77%) of the deep Satilla monitoring and extraction wells had total Hg concentrations less than 20 µg/L. About one-third of these monitoring points (11 out of 30; 37%) had total Hg concentrations less than 2.0 µg/L.

A summary of the overall effect of Phase 1 - 3 sparging on the CBP is presented below:

- CO₂ sparging has been extremely effective at lowering the pH in the deep Satilla aquifer. The mean pH in the deep Satilla monitoring points has decreased from 11.32 (2011-2012) to 7.11 as a result of CO₂ sparging (Table 4-1). The median pH decreased from 11.44 to 6.57 (Table 4-1).
- The SG (and therefore the density) of groundwater within the deep Satilla has decreased as a result of CO₂ sparging. Computed SG decreased in 20 out of 30 deep Satilla monitoring locations. The median computed SG decrease from 1.009 to 1.007 from pre-Phase 1 to post-Phase 3 was statistically significant at the 95% confidence level.
- CO₂ sparging has also been extremely effective at lowering concentrations of Hg in the deep Satilla. Almost every deep Satilla monitoring point (28 out of 30) has lower total Hg when compared to 2011-2012 levels as a result of CO₂ sparging. The mean Hg concentration in all monitoring points was lowered from 270 to 36 µg/L, a percent decrease of 87%. The median Hg concentration in all monitoring points was lowered from 128 to 4 µg/L, a percent decrease of 97%.

Recommendations

The AOC for the caustic brine plume requires that the pH be reduced to 10 to 10.5 and that density be reduced. The three Phase CO₂ sparging effort has clearly met both of these RAOs. To date, rebound of pH to values greater than 10.5 has been minimal during the rest period in-between phases. Therefore, extensive rebound is not expected within the treated area, with the exception of the eastern edge of the northern area, which will be addressed as part of a separate regulatory process for the soils beneath the former cell building. No additional sparging at the Site is recommended as the CO₂ treatment has achieved the RAOs.

Table of Contents

1	Introduction	1-1
1.1	Site Description	1-1
1.2	Summary of Proof of Concept Test.....	1-2
1.3	Summary of Phase 1 of Full-Scale Sparging.....	1-4
1.4	Summary of Phase 2 of Full-Scale Sparging.....	1-5
1.4.1	Technical Objectives of Phase 3.....	1-6
1.4.2	Reporting	1-7
2	System Construction.....	2-1
2.1	Sparge Well Construction	2-1
2.1.1	Sparge Well Locations within the Phase 1 Footprint	2-1
2.1.2	Sparge Well Locations in Southern Area	2-1
2.1.3	Sparge Well Installation and Development	2-1
2.1.4	Monitoring Well Completions.....	2-2
2.1.5	Top of Sandstone and Clay Isopach Mappings	2-2
2.2	CO ₂ Storage, Vaporization, and Distribution System	2-3
3	Procedures and Protocols	3-1
3.1	Groundwater Sampling.....	3-1
3.1.1	Monitoring Wells and Extraction Wells.....	3-1
3.2	Monitoring During Sparging	3-3
3.3	Sparge Operations	3-3
3.3.1	Sparge Regimens	3-3
3.3.2	Required CO ₂ Mass Per Well.....	3-4
3.3.3	Maximum Wellhead Pressures	3-5
3.3.4	Sequence of Operations.....	3-8
3.3.5	Sparge Well and Monitoring Well Maintenance	3-9
3.4	Field Measurements During Sparging.....	3-9
3.5	Measurement and Calculation of Flowrates and CO ₂ Mass	3-9
3.6	Piezometric Surface and Groundwater Table.....	3-10
3.7	Geoprobe Sampling.....	3-11
3.8	Air Monitoring	3-11
4	Results of Phase 3 Sparging.....	4-1
4.1	Sparge Well Flow Rates and Total CO ₂ Mass.....	4-1
4.1.1	CO ₂ Flow Rates	4-1
4.1.2	CO ₂ Total Mass	4-1
4.1.3	CO ₂ Mass Balance.....	4-1
4.2	Effect of Sparging on pH.....	4-2
4.2.1	Pre-sparge pH.....	4-2
4.2.2	pH Monitoring Results During Sparging	4-3
4.2.3	Post-sparge pH Results.....	4-5
4.2.4	Effect of Sparging on Coosawhatchie pH	4-10
4.3	Effect of Sparging on Silica, TDS and Specific Gravity.....	4-10
4.3.1	Effect of Sparging on Silica	4-11
4.3.2	Effect of Sparging on Total Dissolved Solids	4-12
4.3.3	Effect of Sparging on Specific Gravity	4-12
4.4	Effect of Sparging on Mercury.....	4-15

4.4.1	Pre-Sparge Mercury	4-15
4.4.2	Post-Sparge Mercury	4-18
4.4.3	Historical pH and Mercury Concentrations Versus Time	4-23
4.5	Effect of Sparging on Piezometric Surfaces	4-23
5	Conclusions and Recommendations.....	5-1
5.1	Conclusions	5-1
5.2	Recommendations	5-1
6	References.....	6-1

Appendix A. Boring Logs/Well Construction Diagrams

Appendix B. Well Development Logs

Appendix C. Purge Logs

Appendix D. Laboratory Analytical Data

Appendix E. Sparging Flow Rates and Masses

Appendix F. Air Quality Data

Appendix G. Hydrographs

LIST OF TABLES

Table 3-1	Monitoring Points for Phase 3 CO ₂ Sparging
Table 3-2	Water Quality Analytes and Associated Laboratory Methods
Table 3-3	Alkalinity-CO ₂ Dose Relationship
Table 3-4	Calculated Minimum Pneumatic Fracture Initiation Pressure for Phase 1 Sparge Wells
Table 3-5	Calculated Minimum Pneumatic Fracture Initiation Pressure for Phase 2 Sparge Wells
Table 3-6	Calculated Minimum Pneumatic Fracture Initiation Pressure for Phase 3 Sparge Wells
Table 3-7	Summary of Air Monitoring Results
Table 4-1	Summary of Pre- and Post-Sparge pH in Deep Satilla Monitoring Points within the Phase 1 Sparging Footprint
Table 4-2	Summary of Post-Sparge Geoprobe Sampling of Deep Satilla Groundwater in the Southern Area
Table 4-3	Summary of pH Data Collected in Monitoring Wells Screened in the Coosawhatchie A/B Aquifer
Table 4-4	Summary Statistics for Constituents in Deep Satilla Monitoring Points
Table 4-5	Pre- and Post-Sparge Specific Gravity
Table 4-6	Summary of Pre- and Post-Sparge Total Hg in Deep Satilla Monitoring Wells Within the Sparging Footprint
Table 4-7	Summary of Pre- and Post-Sparge Dissolved Hg in Deep Satilla Sparge Wells within the Sparging Footprint
Table 4-8	Summary of Pre- and Post-Sparge Dissolved Hg in Co-located Pairs of Geoprobe Points within the Sparging Footprint
Table 4-9	Summary of Mercury Concentrations in the Deep Satilla
Table 4-10	Difference in Water Levels in Selected Well Pairs

LIST OF FIGURES

- Figure 1-1: Site location map
- Figure 1-2: Map showing location of CBP footprint
- Figure 1-3: Conceptual model of CO₂ sparging
- Figure 2-1: Locations of Phase 3 sparge wells
- Figure 2-2: Locations of northern Phase 3 sparge wells
- Figure 2-3: Locations of southern Phase 3 sparge wells
- Figure 2-4: Locations of piezometers utilized in monitoring Phase 3 CO₂ sparging
- Figure 2-5: Monitoring well network used to evaluate Phase 3 CO₂ sparging
- Figure 2-6: Structural contours of the top of the variably-cemented sandstone
- Figure 2-7: Clay isopach map
- Figure 2-8: Site operations plan
- Figure 2-9: Process and instrumentation diagram
- Figure 3-1: Locations of deep Satilla monitoring and extraction wells
- Figure 3-2: Locations of mid and shallow Satilla monitoring wells
- Figure 3-3: Locations of Coosawhatchie A/B monitoring wells
- Figure 3-4: Interpolated alkalinity in the deep Satilla using data from monitoring locations
- Figure 3-5: Supplemental Geoprobe sampling locations and results for pH
- Figure 4-1: Average flow rates for Phase 3 sparge wells
- Figure 4-2: Average flow rates for Phase 1 and 2 sparge wells
- Figure 4-3: Total CO₂ mass for Phase 3 sparge wells
- Figure 4-4: Total CO₂ mass for Phase 1 and 2 sparge wells
- Figure 4-5: Pre-sparge (2011-2012) pH in deep Satilla monitoring and extraction wells
- Figure 4-6: Pre-sparge (Phase 3) pH in deep Satilla monitoring and extraction wells
- Figure 4-7: Pre-sparge (Phase 3) pH in sparge wells
- Figure 4-8: Pre-sparge (Phase 3) pH in deep Satilla monitoring, extraction, and sparge wells
- Figure 4-9: Pre-sparge (2012) pH in mid Satilla monitoring wells
- Figure 4-10: Pre-sparge (Phase 3) pH in mid Satilla monitoring wells
- Figure 4-11: pH as a function of time for MW-105C, EW-2, and MW-502B during 2012 and Phase 1-3 sparging
- Figure 4-12: pH as a function of time for MW-501B, EW-1, and MW-352B during 2012 and Phase 1-3 sparging
- Figure 4-13: pH as a function of time for MW-514B, EW-4, and MW-513B during 2012 and Phase 1-3 sparging

- Figure 4-14: pH as a function of time for MW-505B, EW-3, and MW-504B during 2012 and Phase 1-3 sparging
- Figure 4-15: pH as a function of time for EW-5, MW-511B, and EW-6 during 2012 and Phase 1-3 sparging
- Figure 4-16: pH as a function of time for MW-512B, EW-8, and MW-515B during 2012 and Phase 1-3 sparging
- Figure 4-17: pH as a function of time for MW-357A, MW-357B, and EW-9 during 2012 and Phase 1-3 sparging
- Figure 4-18: pH as a function of time for MW-518B, MW-516B, and EW-10 during 2012 and Phase 1-3 sparging
- Figure 4-19: pH as a function of time for MW-517B, EW-11, and MW-519B during 2012 and Phase 1-3 sparging
- Figure 4-20: pH as a function of time for MW-1C, MW-2C, and MW-115C during 2012 and Phase 1-3 sparging
- Figure 4-21: pH as a function of time for MW-510B during 2012 and Phase 1-3 sparging
- Figure 4-22: pH as a function of time for MW-503B, MW-353B, and MW-508B during 2012 and Phase 1-3 sparging
- Figure 4-23: pH as a function of time for MW-507B and MW-358B during 2012 and Phase 1-3 sparging
- Figure 4-24: pH as a function of time for MW-112C and MW-113C during 2012 and Phase 1-3 sparging
- Figure 4-25: Post-sparge (Phase 3) pH in deep Satilla monitoring and extraction wells
- Figure 4-26: Post-sparge (Phase 3) pH in sparge wells
- Figure 4-27: Post-sparge (Phase 3) pH in deep Satilla monitoring, extraction, and sparge wells
- Figure 4-28: Post-sparge (Phase 3) pH in southern Geoprobe locations
- Figure 4-29: Post-sparge (Phase 3) pH in mid Satilla monitoring wells
- Figure 4-30: Changes in deep Satilla specific gravity after sparging
- Figure 4-31: Relationship between specific gravity and TDS for deep Satilla groundwater
- Figure 4-32: Changes in deep Satilla computed specific gravity after sparging
- Figure 4-33: Pre-sparge (2011-2012) total mercury in deep Satilla monitoring and extraction wells
- Figure 4-34: Pre-sparge (Phase 3) total mercury in deep Satilla monitoring and extraction wells
- Figure 4-35: Pre-sparge (Phase 3) dissolved mercury in Phase 2 and Phase 3 sparge wells
- Figure 4-36: Pre-sparge (2011-2012) total mercury in mid Satilla monitoring wells
- Figure 4-37: Post-sparge (Phase 3) total mercury in deep Satilla monitoring and extraction wells
- Figure 4-38: Box plot of mercury concentrations in deep Satilla monitoring locations
- Figure 4-39: Post-sparge (Phase 3) dissolved mercury in sparge wells
- Figure 4-40: Post-sparge (Phase 3) total and dissolved mercury in deep Satilla monitoring, extraction and sparge wells
- Figure 4-41: Post-sparge (Phase 3) dissolved mercury in southern Geoprobe locations

- Figure 4-42: Relationship between Hg and pH in deep Satilla monitoring locations
- Figure 4-43: Post-sparge (Phase 3) total mercury in mid Satilla monitoring wells
- Figure 4-44: Historical pH and Hg in MW-519B and MW-115C
- Figure 4-45: Historical pH and Hg in EW-6 and EW-11
- Figure 4-46: PZ-63 hydrograph and daily precipitation data
- Figure 4-47: MW-515B and MW-112C hydrographs

LIST OF ACRONYMS

AOC	Agreement and Order on Consent
ARCO	Atlantic Refining Company
As	Arsenic
bgs	Below ground surface
CBP	Caustic brine pool
CaCO ₃	Calcium carbonate
CO ₂	Carbon dioxide
CO ₃ ²⁻	Carbonate ion
Cr	Chromium
Cr(III)	Trivalent chromium
Cr(VI)	Hexavalent chromium
CPT	Cone Penetrometer Test
DOM	Dissolved organic matter
DP	Distribution Panel
EPA	Environmental Protection Agency
EW	Extraction Well
ft	Feet
ft/d	Feet per day
gpm	Gallons per minute
Hg	Mercury
HDPE	High-density polyethylene
kW	Kilowatt
lb	Pounds
LCP	Linden Chemicals and Plastics
MW	Monitoring well
n	Sample size
NAVD	North American Vertical Datum
NA	Not available
NM	Not measured
NTU	Nephelometric turbidity unit
ORP	Oxidation reduction potential
P&ID	Process and instrumentation drawing
ppmv	Part per million by volume
psi	Pounds per square inch (gauge)
psia	Pounds per square inch – absolute
PVC	Poly vinyl chloride
PZ	Piezometer
RAO	Remedial Action Objective
RI	Remedial Investigation
ROI	Radius of influence
scfm	Standard cubic feet per minute
Si	Silica
SG	Specific gravity
SW	Sparge well
TDS	Total dissolved solids
µg/L	Microgram per liter

1 INTRODUCTION

Mutch Associates, LLC (Mutch), in collaboration with Parsons Environment & Infrastructure Group, Inc. (Parsons), have prepared this report of Phase 3 of carbon dioxide (CO₂) sparging at the LCP Chemicals Site in Brunswick, Georgia (Site). Phase 3 of CO₂ sparging was conducted in accordance with the *CO₂ Sparging Work Plan, LCP Chemicals Site, Brunswick, GA* dated April 24, 2013 (Sparging Work Plan) (Mutch Associates and Parsons, 2013a) and the *Technical Approach for Phase 3 CO₂ Sparging, LCP Chemicals Site, Brunswick GA (Revision 1)* dated September 1, 2015 (Phase 3 Memo) (Mutch Associates, 2015b). Formal approval of the Sparging Work Plan and Phase 3 Memo were granted by the U.S. Environmental Protection Agency, Region 4 (EPA) on May 1, 2013 and January 7, 2016, respectively. The CBP is being addressed under an Administrative Settlement Agreement and Order on Consent (AOC) entered into between EPA and Honeywell on April 18, 2007. The remedial action objectives (RAO) were defined in the AOC and included reducing the pH of the CBP to between 10 and 10.5 and reducing the density of the CBP.

This report describes the implementation and monitoring results related to Phase 3 of CO₂ sparging and summarizes the effect of all three phases of sparging on groundwater quality within the deep Satilla aquifer beneath the Site. This report is organized in the following manner:

- Section 1 – Introduction and background;
- Section 2 – Describes the sparge well installation and sparge system construction;
- Section 3 – Describes the specific procedures and protocols employed during sparging;
- Section 4 – Presents the results of sparging on pH, specific gravity, mercury (Hg), other geochemical parameters, and groundwater levels; and
- Section 5 – Conclusions and recommendations.

1.1 Site Description

The Site is located at 4125 Ross Road,¹ in the City of Brunswick, in Glynn County, Georgia, and is bordered by the Turtle River marshes to the west and south and urban areas of Brunswick to the north and east. The Site encompasses approximately 813 acres, of which 684 acres are tidally influenced salt marsh. A Site location map is provided in Figure 1-1.

During chemical production activities at the Site, a portion of the shallow aquifer was contaminated by releases from the chlor-alkali-manufacturing operations and a subsurface CBP formed. The CBP is

¹ A site address was developed as part of the County's upgrade to its 911-emergency system.

defined in the AOC as groundwater with a pH above 10.5. The dashed line on Figure 1-2 shows the location and extent of the CBP based on pH data collected in 2012.² The area within the 10.5 contour was 8.6 acres.

In July and August of 2014, Honeywell performed groundwater sampling via Geoprobe at the base of the Satilla aquifer along the southern boundary of the CBP as mapped in 2012. The purpose of this sampling was to improve delineation of the extent of the high pH (> 10.5) plume. Further details on this sampling are provided in the Phase 2 final report. Results of the re-mapping of the pH > 10.5 plume are shown as the solid line in Figure 1-2. Addition of the southern area increased the area of the CBP to 13.9 acres.

1.2 Summary of Proof of Concept Test

Full-scale CO₂ sparging was preceded by a Proof of Concept Test. The Proof of Concept Test was conducted from October 29, 2012 to November 17, 2012 in accordance with the *Final Work Plan for CO₂ Sparging Proof of Concept Test, LCP Chemicals Site, Brunswick, GA* (Proof of Concept Test Work Plan) dated September 11, 2012 (Mutch Associates, 2012). EPA approved the Proof of Concept Test Work Plan in a letter dated September 10, 2012. The Proof of Concept Test was designed to evaluate the feasibility of CO₂ sparging to remediate the CBP (Figure 1-3).

Key observations from the Proof of Concept Test that are relevant to the design and implementation of full-scale sparging, as described in the *CO₂ Sparging Proof of Concept Test Report* (Mutch Associates and Parsons, 2013b) are:

1. Significant pH reductions from pH 11-12 in the deep Satilla were achievable in 5 to 7 days sparging at circa 50 standard cubic feet per minute (scfm).
2. A radius of influence (ROI) of at least 20 feet was achieved in the deep Satilla and greater than 60 feet (ft) at the water table surface.
3. Hg levels in the high pH CBP waters fully-impacted by the sparging declined from 110-120 µg/L to 11-33 µg/L (70 to 90% reductions).
4. During sparging, significant mounding of the potentiometric surface was observed. Shallow Satilla wells within the 20-ft radius of sparge wells increased to within 1 ft of the ground surface.

² The mapping of the CBP (Figure 1-2) was created by kriging pH data from deep Satilla monitoring wells (MW series) from the May/June 2012 monitoring event, supplemented with data from September 2011 for extraction wells (EW series). For most wells, field pH values were used for the mapping. The only exceptions were MW-357A, MW-357B, MW-512B and MW-516B, where laboratory pH was conservatively used because field pH was considerably lower than historic values. Well MW-113C was not included in kriging because of poor resolution in this area of the site.

5. Significant rebound of pH or Hg was not observed based on results from groundwater monitoring conducted three months after completion of sparging.

The Proof of Concept Test demonstrated that CO₂ sparging is an effective, innovative technology, suitable for full-scale implementation at the Site (Figure 1-3). Observations made during testing further demonstrated that full-scale implementation of CO₂ sparging should be conducted over a multiple-year, sequential effort. The principal drivers for this sequential implementation were:

- Management of groundwater mounding caused by superposition of multiple, closely-spaced sparge wells; and
- Maximization of sparging efficiency.

The Proof of Concept Test indicated that managing groundwater mounding during full-scale implementation would be critical. The groundwater table rose to within 1 ft of the ground surface during the testing. This potential for mounding could be exacerbated by superposition of mounding from multiple nearby sparging wells and by seasonal rises of the groundwater table. Moreover, in some areas of the CBP, the water table is even closer to the surface than at the test site. These factors could impose a practical limit on the spacing of wells and the number of wells that could be sparged simultaneously. Conducting the implementation over multiple years would allow active sparge wells to be further apart, thereby reducing the superposition of groundwater mounding.

The Proof of Concept Test suggested that CO₂ sparge efficiency could be enhanced by a sparge regimen that emphasizes short bursts of sparging (anywhere from ½ to 4 hr) followed by rest periods. The rest periods would allow CO₂ gas residual saturation remaining in the formation to both dissolve and diffuse into the surrounding CBP waters. The Proof of Concept Test Report concluded that different sparge regimens should be tested during the first year of sparging in an effort to optimize sparge efficiency.

The Proof of Concept Test results also showed that the pH reached target levels in the deep Satilla at least 20 ft away from sparge well MW-1C (Mutch Associates and Parsons, 2013b). This indicated an effective ROI of at least 20 ft in the deep Satilla. Modest decreases in pH in deep Satilla wells were observed at radial distances greater than 20 ft, indicating some consumption of CO₂ demand. The ROI in the intermediate and shallow Satilla was significantly larger than 20 ft. For example, gas channels extended all the way from MW-1C to MW-517A, which is a distance of approximately 100 ft. As a result, there was some uncertainty regarding the ROI that would be achieved during full-scale implementation. The Proof of Concept Test Report indicated that further evaluation of ROI could be achieved by using an initial coarse grid spacing for sparge wells during the first year of sparging, followed by filling-in with a denser well spacing in future efforts based on observed results.

Although Hg concentrations are not a component of the AOC, the performance of the CO₂ sparging with respect to its impact on Hg concentrations was monitored. The Proof of Concept Test results showed a clear trend of decreasing Hg concentrations with decreasing pH as a result of CO₂ sparging. Furthermore, monitoring in these same wells showed a gradual lowering of dissolved Hg concentrations over time at a given pH (Mutch Associates and Parsons, 2013c). This effect appeared after 3 months and was sustained through 6 months after sparging was completed.

1.3 Summary of Phase 1 of Full-Scale Sparging

As described in the EPA-approved Sparging Work Plan (Mutch Associates and Parsons, 2013a), the technical objectives of Phase 1 of full-scale sparging were the following:

- Reduce pH as determined by measurements in deep Satilla monitoring wells and extraction wells;
- Determine the average ROI of sparging to develop a technical approach for Phase 2 of CO₂ sparging;
- Determine the optimal sparging regimen to maximize CO₂ utilization efficiency; and
- Reduce Hg concentrations as determined by comparison of pre- and post-sparging concentrations in mid and deep Satilla monitoring wells.

Phase 1 of CO₂ sparging at the Site is described in detail in the *CO₂ Sparging Phase 1 Full-scale Implementation and Monitoring Report, Revision 1* (Phase 1 Report), dated June 20, 2014 (Mutch Associates and Parsons, 2014). Phase 1 sparge wells were placed approximately 80 ft apart on a coarse, semi-regular, hexagonal grid pattern (Mutch Associates and Parsons, 2013a). This layout provided flexibility for various final sparge well spacings by placing additional sparge wells on the grid. Sparging was performed from November 8, 2013 to February 13, 2014. A total of 783,000 lb of CO₂ was sparged during Phase 1.

A summary of the key results from Phase 1 is presented below:

- All of the technical objectives of Phase 1 of CO₂ sparging were met.
- Sparging was effective in reducing the pH of the CBP groundwater. Following Phase 1 of sparging, 14 out of 15 deep Satilla monitoring points within a radial distance of 30 ft from a sparge well had a post-sparge pH < 10.0, and 13 out of 15 monitoring points had a post-sparge pH < 7.5. Many wells at distances greater than 30 ft showed significant decreases in pH.
- An average ROI of 32.9 ft was estimated from the pH versus distance data. This is considerably larger than the approximate 20 ft ROI measured in the Proof of Concept Test.

- The optimal sparging regimen was Regimen A (once per week). Some sparge wells required longer sparge durations of 8 to 24 hr to provide adequate flow.
- The efficiency of CO₂ sparging was evaluated by comparing the CO₂ demand of the CBP with the amount of CO₂ mass required to lower the pH to circumneutral and found to be 29%. This efficiency was approximately three times larger than the efficiency estimated from the Proof of Concept Test (9.7%).
- CO₂ sparging resulted in a significant decline in aqueous-phase Hg concentrations. In monitoring points where post-sparge pH was less than 7.5, the mean Hg concentration decreased from 94 µg/L to 21 µg/L (n = 22), a decrease of 78%.
- The pre-and post-sparging aquifer testing showed no sharp loss of aquifer transmissivity. The mean of six pre-sparge well specific capacities was 0.011 gpm/ft. The mean of ten post-sparge specific capacities measured approximately 2 weeks after sparging was 0.035 gpm/ft.
- The pre-sparge aquifer testing indicated that the basal Satilla varies in hydraulic conductivity within the CBP from 2 to 17 ft/d, with a mean value of 9.9 ft/d. The Proof of Concept pre-sparging aquifer test had previously measured a hydraulic conductivity of 8.9 ft/d in that area of the Site.
- A significant fraction of the injected CO₂ remained in the formation as residual CO₂ saturation and was not vented to the atmosphere. The emplacement of CO₂ residual saturation into the Satilla provides a long-term source of pH-neutralization and Hg immobilization for water flowing from upgradient locations. This may also serve as protection against pH rebound.
- As the CO₂ residual saturation dissolves into the surrounding groundwater, a process that could take months or years, aquifer properties such as hydraulic conductivity and storativity should concomitantly approach pre-sparge levels, except for whatever impact the minimal reduction in porosity may have on these properties. Experience during the Proof of Concept Test and Phase 1 suggested that these latter impacts were not of particular concern.

1.4 Summary of Phase 2 of Full-Scale Sparging

The technical objectives of Phase 2 sparging was to continue to make progress in meeting the RAOs in the deep Satilla groundwater. Phase 2 of CO₂ sparging at the Site is described in detail in the *CO₂ Sparging Phase 2 Full-scale Implementation and Monitoring Report, Revision 1* (Phase 2 Report), dated September 1, 2015 (Mutch Associates and Parsons, 2015). Based on the average radius of influence (ROI) observed during Phase 1 of 33 feet (ft), the final layout of Phase 2 sparge wells within the Phase 1 sparging footprint was designed to form sparge “columns,” with consideration given to overlap. A total of 58 Phase 2 sparge wells were installed within the Phase 1 footprint (SW-66 through SW-123).

Prior to the Phase 2 sparging, the southern boundary of the CBP was further defined via a Geoprobe sampling program that delineated the extent of the high pH plume to the south. This newly delineated “southern area” was added to the sparging program, bringing the total area to 13.9 acres. This southern area was treated for the first time as part of Phase 2 sparging, utilizing 22 new wells. Phase 2 sparge wells in the southern area were placed approximately 114 ft apart on a coarse, semi-regular, hexagonal grid pattern. This was done so that a final spacing of 66 ft (consistent with a 33 ft ROI) could be achieved by placing additional sparge wells in Phase 3 at the geometric center of triangles formed by the Phase 2 wells.

Sparging was performed from October 17, 2014 to April 28, 2015. The total amount of CO₂ injected during Phase 2 was 1,521,000 lb. Phase 2 sparge wells received 1,199,000 lb while Phase 1 sparge wells received additional 321,000 lb.

A summary of the key results from Phase 2 is presented below:

- Only four deep Satilla monitoring points within the sparging footprint had a pH above 10.5 after Phase 2 sparging.
- Post-sparge Geoprobe groundwater sampling of pH in the southern area supported the selected ROI of 33 ft within the Phase 1 footprint.
- The mean Hg concentration in Phase 2 monitoring points where the pH was less than 10.5 was 12.4 µg/L, an 89% reduction from pre-Phase 1 levels.
- Hg measurements throughout the entire sparging program showed that additional reductions in Hg should occur over time as groundwater remains at neutral pH.

1.4.1 Technical Objectives of Phase 3

The technical objectives of Phase 3 sparging were to build upon the success of the first two phases and to finally achieve the RAOs within the deep Satilla aquifer. Specifically, Phase 3 addressed two areas within the Phase 1 footprint and completed treatment in the southern area. These are discussed in more detail below.

By the end of Phase 2, treatment within the Phase 1 footprint was largely complete. However, at the end of Phase 2, two monitoring points along the eastern edge (MW-352B and MW-513B) and two monitoring point along the western edge (EW-5) of the sparging footprint did not achieve a circumneutral final pH (Phase 2 Report). In addition, the pH increased above 10.5 in one monitoring well just outside the sparging footprint (MW-510B). To address these areas, a total of 14 wells were installed within the Phase 1 footprint. Two wells were installed near EW-5 and MW-510B. The remaining twelve wells were installed along the eastern edge of the sparging footprint to address high pH groundwater near MW-352B

and MW-513B. Ten of these wells form a “sparge column” to treat groundwater that may be entering the sparging footprint from the east

The conceptual layout for the southern area, first presented in the Phase 2 technical memo (Mutch Associates, 2014), featured a coarse hexagonal grid pattern where Phase 2 sparge wells are 114.3 ft apart. Post-Phase 2 Geoprobe sampling of groundwater in the southern area demonstrated sparging influence that was consistent with the 33 ft ROI observed during Phase 1. Therefore, a final spacing of 66 ft (consistent with a 33 ft ROI) was achieved by placing additional sparge wells at the geometric center of triangles formed by the Phase 2 wells.

1.4.2 Reporting

Data collected during Phase 3 sparging is compiled and evaluated in this report. Specifically, this report contains the following information:

- Borings / well construction logs for sparge wells installed prior to Phase 3 sparging;
- A tabular summary of injection activities at each well, including mass of CO₂ injected per event;
- Changes in pH and specific gravity observed in the monitoring well network;
- Pre- and post-sparge groundwater monitoring results of other constituents such as Hg, total dissolved solids (TDS), silica (Si), arsenic (As) and chromium (Cr);
- A description of supplemental Geoprobe sampling of deep Satilla groundwater along the western edge of the sparging footprint to delineate the extent of the pH 10.5 plume;
- Recommendations for future activities relating to groundwater at the Site.

2 SYSTEM CONSTRUCTION

2.1 Sparge Well Construction

2.1.1 Sparge Well Locations within the Phase 1 Footprint

To address the identified high pH areas within the Phase 1 footprint, 14 new sparge wells (SW-196 through SW-209) were installed (Figure 2-1 and Figure 2-2). Two of these sparge wells (SW-196 and SW-197) were installed north of SW-23 to treat areas near EW-5 and MW-510B. Twelve sparge wells (SW-198, SW-199, SW-200 through SW-209) were placed along the eastern edge of the Phase 1 footprint near the existing infiltration galleries. Two of these twelve sparge wells were located west of the galleries, to fill a small gap in sparging coverage south of SW-121. The remaining ten sparge wells form a “sparge column” to treat groundwater that may be entering the sparging footprint from the east. The wells that form the sparge column were spaced approximately 50 ft apart so that there is significant overlap between adjacent ROI.

2.1.2 Sparge Well Locations in Southern Area

The conceptual layout for the southern area was first presented in the Phase 2 technical memo (Mutch Associates, 2014). This layout featured a coarse hexagonal grid pattern where Phase 2 sparge wells are 114.3 ft apart. Post-Phase 2 Geoprobe sampling of groundwater in the southern area demonstrated sparging influence that was consistent with the 33 ft ROI observed during Phase 1. Based on this result, a total of 50 sparge wells were installed in the southern area during Phase 3 (SW-146 through SW-195). Consistent with the conceptual layout, Phase 3 sparge wells completed the grid in the southern area with a final spacing of 66 ft on center. The as-built locations of the Phase 3 wells are shown on Figure 2-1 and Figure 2-3. Sparge wells SW-180 through SW-182 are located outside the pH 10.5 contour in the southern area, but were installed and sparged to lower dissolved Hg concentrations in this area which ranged from 31 to 76 µg/L (Mutch Associates and Parsons, 2015). Slight alterations to the regular grid were needed for SW-177 and SW-178, due to an existing concrete wall on the Site.

2.1.3 Sparge Well Installation and Development

Sparge wells were constructed with 2 ft of 2-inch diameter, 0.010-inch slotted Schedule 40 PVC screen with a 2-inch Schedule 40 PVC riser. At most locations, permeable aquifer material (i.e. fine to medium sand) was encountered directly above the variably-cemented sandstone. At these locations, the well screen was set at the top of the variably-cemented sandstone. When less permeable aquifer material unsuitable for sparging was present at the base of the Satilla aquifer (i.e. silt, very fine sand, sand with little to some silt), the screen was set at the deepest interval where the more permeable aquifer material (i.e. fine

to medium sand) was encountered. When a clay stratum was encountered directly above the variably-cemented sandstone, the well screen was set in permeable aquifer material at the base of the clay stratum, after grouting the boring to the top of the clay with 95% Type 2 Portland / 5% bentonite if the clay had been penetrated greater than 6 in. Well construction was completed with a 20/30 sand pack to 2 ft above the top of screen, followed by a 2-ft bentonite seal, and cement grout to the surface. Boring logs / well construction diagrams are provided in Appendix A in a standardized form and for all three phases of sparge well installation.

Following installation, sparge wells were developed by removing an average of 70 gallons of water with the goal of achieving a turbidity of 50 Nephelometric Turbidity Units (NTU). During well development, yields less than 0.5 gallons per minute (gpm) were observed in a number of sparge wells; these wells were surged with a surge block to improve yield. Final yields and water quality data (i.e. pH, specific conductance) obtained during well development are included in the summary table provided in Appendix B.

No additional shallow piezometers were installed during Phase 3 since there were already 35 piezometers to monitor shallow groundwater rise. The locations of the piezometers installed during Phases 1 and 2 are provided in Figure 2-4.

2.1.4 Monitoring Well Completions

The monitoring well network used to evaluate Phase 3 CO₂ sparging is shown on Figure 2-5. To reduce the potential for groundwater surfacing, threaded plugs were installed on all monitoring wells within the sparging footprint to contain the possible rise of water. Similar to Phases 1 and 2, the monitoring wells were outfitted with fittings and ports to allow for instrumentation cables and manual pressure measurements (Mutch Associates and Parsons, 2014).

2.1.5 Top of Sandstone and Clay Isopach Mappings

The mapping of the top of the variably-cemented sandstone was updated prior to Phase 3 sparge well installation. This map was used to estimate depth of the variably-cemented sandstone from ground surface at planned Phase 3 sparge well locations (Figure 2-1 through Figure 2-3). Field data for the elevation of the top of the variably-cemented sandstone was gathered from Phase 1 and 2 sparge well boring logs, boring logs from Site monitoring wells and extraction wells, Geoprobe drilling reports, Cone Penetrometer Tests (CPTs), and exploratory borings from the Remedial Investigation (RI). The elevation data was catalogued and consolidated into a master database and used as the basis for interpolation of the top of variably-cemented sandstone elevation over the entire Site. The interpolation was accomplished

using Ordinary Kriging with 2nd order trend removal with the Geostatistical Analyst package of ArcGIS (ESRI).³ The map (Figure 2-6) shows the variably-cemented sandstone as a continuous unit at elevations varying from -39.5 to -43.0 ft (NAVD 88). The variably-cemented sandstone surface generally deepens moving north-northwest (NNW) across the sparging footprint.

A clay isopach map was prepared in order to estimate the location and thickness of clay deposition to assist in well screen placement (Figure 2-7). Data used for the clay isopach map was obtained from the same sources as the top elevation of the variably-cemented sandstone described above. Clay thickness was interpolated over the entire sparging footprint using inverse-distance weighting interpolation with the Geostatistical Analyst package of ArcGIS. Clay is not pervasive in the subsurface, and is typically thicker in the northern portion of the sparging footprint.

2.2 CO₂ Storage, Vaporization, and Distribution System

Equipment to store, vaporize, and distribute CO₂ to the sparge wells was installed at the Site in October and November 2013, as summarized below.

- Storage and vaporization equipment included two 50-ton refrigerated bulk tanks for liquid CO₂ storage, two 105-kW process vaporizers to convert liquid CO₂ to gaseous form, pressure regulators to reduce CO₂ line pressure from 300 pounds per square inch (psi) to a field delivery pressure of approximately 50 psi, a trim heater to adjust the final temperature of the gaseous CO₂, a flow meter, and other instrumentation and controls.
- Distribution system equipment included distribution piping, eight distribution panels (DPs), portable hoses, and instrumentation. The distribution panels included three 1-inch branch lines following the upstream pressure regulator; each branch line included a downstream pressure regulator and a flow meter (rotameter). A temperature gauge also was provided at each distribution panel. Temperature measurements, together with the flow and pressure measurements, were used to estimate CO₂ mass sparged into each sparge well.

Further detail regarding the equipment installed to support sparging is described in the Phase 1 Report (Mutch Associates and Parsons, 2014). Various system components installed during Phase 1 are also illustrated below.

³ Ordinary Kriging was performed using an experimental semivariogram (lag size: 43.3 ft, number of lags: 12) modeled with a Gaussian function optimized to reduce root mean square error (nugget: 1.84, major range: 346.6, partial sill: 0.453). Kriging was performed using a search neighborhood of 4 sectors with 45 degree offset (min/max neighbors: 10/15).

Based on the investigations described in the Phase 2 report, the sparging footprint was expanded to the south. To accommodate Phase 2 and Phase 3 sparging in this area, three additional distribution panel locations were established (DP-9, DP-10, and DP-11), and approximately 800 ft of additional distribution piping was installed at the Site in September and October 2014, as shown on Figure 2-8. On January 7, 2015, distribution panels were shifted from locations DP-1, DP-5, and DP-8 (following substantial completion of sparging at these locations), to locations DP-11, DP-10, and DP-9, respectively, to allow for sparging in the south and southwest. A process and instrumentation drawing (P&ID) illustrating the additional piping and distribution panels is provided as Figure 2-9.



Left: 105-kW process vaporizers.



Right: 50-ton CO₂ storage tanks

Pressure Gauge

Bleed Valve

Sparge Well

CO₂ Gas Delivery
Hose to Sparge Well



Above: Typical distribution panel. **Below:** Typical sparge wellhead installation

Rotameter for Flow
Measurement (with
Needle Valve)

Downstream
Pressure Regulator

Upstream
Pressure
Regulator



Temperature
Gauge

3 PROCEDURES AND PROTOCOLS

3.1 Groundwater Sampling

3.1.1 Monitoring Wells and Extraction Wells

Prior to and following CO₂ sparging, specific monitoring and extraction wells were sampled to provide baseline and post-sparge groundwater quality data. Post-sparge sampling of Satilla monitoring wells occurred approximately 2 weeks after the end of Phase 3 sparging. The monitoring wells and extraction wells that were sampled are presented on Table 3-1. The locations of deep Satilla monitoring wells are shown in Figure 3-1; mid Satilla monitoring wells are shown in Figure 3-2.

Table 3-1: Monitoring Points for Phase 3 CO₂ Sparging

Deep Satilla Monitoring Wells			
MW-105C ^(b)	MW-357B	MW-507B ^(a)	MW-515B
MW-112C ^(a,b)	MW-358B ^(a)	MW-508B ^(a)	MW-516B ^(b)
MW-113C ^(a,b)	MW-501B ^(b)	MW-510B ^(a)	MW-517B
MW-115C ^(b)	MW-502B ^(b)	MW-511B ^(b)	MW-518B ^(b)
MW-352B	MW-503B ^(a,b)	MW-512B ^(b)	MW-519B
MW-353B ^(a)	MW-504B ^(b)	MW-513B ^(b)	MW-1C
MW-357A	MW-505B	MW-514B ^(b)	MW-2C
Deep Satilla Extraction Wells			
EW-1	EW-4	EW-8	EW-11
EW-2	EW-5	EW-9	
EW-3	EW-6	EW-10	
Mid Satilla Monitoring Wells			
MW-352A	MW-504A	MW-513A	MW-517A
MW-502A	MW-505A	MW-514A	

^(a) Indicates a well outside of the sparging area which served as a background monitoring well.

^(b) Indicates well was selected for measurement of specific gravity in the field pre-and post-sparging.

Wells were purged and sampled using the low flow “Tubing-in-Screened-Interval” method, pursuant to the groundwater sampling operating procedure (effective date March 2013) contained in the *Field Branches Quality System and Technical Procedures* (<http://www.epa.gov/region4/sesd/fbqstp/index.html>) (USEPA Region 4 Science and Ecosystem Support Division, 2013). The guidance document *Groundwater Sampling Guidelines for Superfund and RCRA Project Managers* (Yeskis and Zavala, 2002) was also referenced for additional technical support. Per the method, the tubing intake was lowered to the middle of the screened interval of the well, and a peristaltic pump was used to purge the groundwater at a low flow rate. Throughout the purge process, depth-to-water measurements were collected to assess and maintain stable drawdown. A minimum one equipment volume was purged prior to stabilization parameters (pH, specific conductivity, dissolved oxygen, and turbidity). Although not considered stabilization

parameters, temperature and oxidation reduction potential were also recorded. Once the required parameters were stable for three consecutive readings, and goals for turbidity had been reached,⁴ groundwater samples were collected for laboratory analysis as described in Table 3-2.

Table 3-2: Water Quality Analytes and Associated Laboratory Methods

Analyte	Method	Description
pH	EPA SW-846 9040B	Ion selective electrode
Alkalinity	SM 2320B	Potentiometric titration
Total Hg Filtered/dissolved Hg ^(a)	EPA SW-846 7470A	Cold-vapor atomic absorption spectrophotometry
Total dissolved solids	SM 2540C	Gravimetric
Total metals & silica ^(b)	EPA SW-846 6010B	Inductively Coupled Plasma – Atomic Emission Spectroscopy

^(a) If after 2 hours of purging or 5 well volumes had been purged, and turbidity was still greater than 50 NTUs, a filtered sample for Hg was also collected.

^(b) Total metals included aluminum, arsenic, barium, beryllium, calcium, cobalt, chromium, iron, potassium, magnesium, manganese, sodium, nickel, selenium, vanadium, zinc.

The groundwater samples were preserved on ice and submitted to TestAmerica Laboratories in Savannah, GA for analysis. Once the groundwater samples had been collected, approximately 900 mL of groundwater were pumped into a graduated cylinder and the specific gravity was determined using a hydrometer for those wells indicated on Table 3-1. Purge logs, including a summary of stabilization parameters and specific gravity measurements, are provided in Appendix C. All of the water quality data collected as part of Phase 3 sampling is presented in Appendix D.

A subset of groundwater samples collected from extraction wells (EWs) during this and previous monitoring events had sodium concentrations and specific conductance values much lower than historical values. The well casings of extraction wells are located in subsurface vaults that are susceptible to infiltration from rainwater or shallow groundwater when there is a high groundwater table. This infiltration of rain water or shallow groundwater likely resulted in some samples from extraction wells that are not entirely representative of the CBP. For the purpose of this assessment, when measured sodium concentration or specific conductance values from Phase 3 sampling were less than 40% of historical averages, the groundwater samples were considered non-representative of deep Satilla groundwater. The only extraction well sampled during Phase 3 monitoring that was affected by dilution was EW-10 (post-Phase 3). As a result, the post-Phase 3 sample from this well was not submitted to the laboratory for analysis of other parameters. Water quality measurements (i.e. Hg, Si and TDS, etc.) from extraction wells that were suspected to be affected by dilution throughout Phases 1 – 3 are not displayed on figures or used to

⁴ Goals for turbidity were: less than 10 NTUs or a minimum 1-hr purge with turbidity less than 50 NTUs and with turbidity measurements within 10%; or a minimum 5-well volume purge or 2-hr purge, whichever occurred first.

calculate averages or percent removals. It should be noted that pH values collected in these extraction wells were considered to be not significantly affected by this dilution because of the logarithmic scale of pH. A 10:1 dilution of deep Satilla is required to bias measured pH values low by one standard unit. The pH measured in the extraction wells described above were included in figures and included in summary tables of this report.

3.2 Monitoring During Sparging

Groundwater pH and conductivity were measured throughout the sparging program in all monitoring points within the sparging footprint. A portable peristaltic pump was used to pump water to the surface. Tubing was lowered to the mid-point of the screen and water was pumped with a flow rate that ranged from 0.25 to 2.50 L/min. The water passed through a flow cell equipped with a YSI Professional Plus multi-parameter probe that measured pH, specific conductance, barometric pressure, and temperature. The probe was set to take readings every 30 seconds. Wells were pumped until all parameters were stabilized over three consecutive readings. The final stabilized reading was used as the data point of record. The data was recorded on the internal memory of the meter and was reported at the end the day.

Field measurements of pH and conductivity occurred at a frequency of approximately once per week in deep Satilla monitoring points within the sparging footprint. Several wells to the west of the sparging footprint were sampled approximately once per month to assess lateral migration of the CBP. A few deep Satilla monitoring wells to the east of the sparging footprint were sampled at the end of Phase 3. In addition, wells screened in the Coosawatchie A/B formation (HWEast2, HWEast3, HWEast5, MW-352D, MW-115, and MW-360D) were sampled at the end of Phase 3 operations to assess effect of sparging on pH (Figure 3-3). Shallow Satilla monitoring wells were not monitored as part of Phase 3 sparging effort.

All pH electrodes were calibrated daily to ensure accuracy of results. A three-point standard curve using pH 4.01, 7.00, and 10.01 was used. A valid pH calibration curve was obtained only when the slope was within 5% of the theoretical value of -59 mV/pH . Specific conductance was also calibrated daily. A calibration check was performed at least once per day to ensure electrode stability.

3.3 Sparge Operations

3.3.1 Sparge Regimens

Phase 1 of CO₂ sparging tested four sparging regimens to optimize CO₂ efficiency (Mutch Associates and Parsons, 2014). The Phase 1 Report recommended a once per week regimen with a 4-hr duration to start, with adaptive management to optimize well-specific performance. Phase 1 sparging also indicated that specific wells needed longer sparging intervals (e.g. 8 or 24 hr) to provide adequate mass

flows of CO₂. Since this approach was successful in Phases 1 and 2, the same procedures were applied throughout Phase 3 of CO₂ sparging.

3.3.2 Required CO₂ Mass Per Well

During Phase 1 sparging, an overall mass of at least 8,000 to 9,000 lb of CO₂ per sparge well was estimated to treat moderate alkalinity groundwater (< 4,000 mg/L CaCO₃). Areas of higher alkalinity were sparged at approximately 1.5-times (12,000 lb) to 2-times (16,000 lb) this amount to account for the increased demand. To prepare for Phase 2, alkalinity was measured in select sparge wells and Geoprobe locations. This information was combined with deep Satilla alkalinity data collected prior to Phase 1 to interpolate alkalinity across the entire sparging footprint. This alkalinity map was further updated with additional information from Phase 3 sparge wells in the northern area of the Site (Figure 3-4).⁵ The interpolated alkalinity map shows high alkalinity areas in the northern portion of the Site near the elevated pad, and in the southwestern area of the Site.

To refine the estimate of CO₂ dosing in high alkalinity areas, the total mass of CO₂ was scaled from the 8,000 lb baseline established in Phase 1 using the following procedure. First, the average alkalinity within a 33-ft radius of each sparge well was estimated using the interpolated alkalinity map (Figure 3-4) and the zonal statistics toolbox of ArcGIS (version 10.3). Second, an alkalinity multiplier was calculated for each sparge well by dividing the average alkalinity by 4,000 mg/L as CaCO₃ (the baseline alkalinity from Phase 1). Finally, the required CO₂ dose was determined by scaling up the baseline in a linear fashion according to Table 3-3.

This method of calculating required CO₂ mass was also retroactively applied to Phase 1 and 2 sparge wells. In light of the new alkalinity data, a small number of Phase 1 and 2 sparge wells had less than the required CO₂ mass using the linear scale-up method described above. Therefore, these wells were sparged during Phase 3 to achieve the revised target. In addition, Phase 2 sparge wells in the southern area that had already met the new mass requirements received approximately 2,000 lb of CO₂ during Phase 3. The purpose of the additional sparging was to treat high pH groundwater that may have moved into the zone of influence of a Phase 2 well during sparging of Phase 3 sparge wells. A secondary benefit of sparging

⁵ This map was created using the radial basis function interpolator in ArcGIS Geostatistical Analyst. Data used for the interpolation are indicated on Figure 3-4. Phase 2 sparge wells with a pH <10.5 were excluded from the interpolation data set because they were assumed to have been influenced by Phase 1 sparging. MW-105C was replaced with March 2014 data because of an error in reporting of alkalinity from the lab. The data set was supplemented with alkalinity values from 2010 (MW-101C, MW-106C, MW-304C, MW-306B, MW-351B, MW-355B), 2006 (MW-307B), and 2003 (MW-114C and MW-116C).

these wells was the replenishment of the residual saturation of CO₂ which helps protect against long-term rebound of pH.

Table 3-3: Alkalinity-CO₂ Dose Relationship

Average Alkalinity within ROI (mg/L as CaCO ₃)	Alkalinity Multiplier	CO ₂ dose (lb)
Less than 4,000	Less than 1.00	8,000
4,001 to 6,000	1.01 to 1.50	12,000
6,001 to 8,000	1.51 to 2.00	16,000
8,001 to 10,000	2.01 to 2.50	20,000
10,001 to 12,000	2.51 to 3.00	24,000
12,001 to 14,000	3.01 to 3.50	28,000
14,001 to 16,000	3.51 to 4.00	32,000
16,001 to 18,000	4.01 to 4.50	36,000
18,001 to 20,000	4.51 to 5.00	40,000

The only sparge well that was an exception to the CO₂ dosing described above was SW-124. Prior to the start of Phase 2, pre-sparge sampling of SW-124 indicated pH < 10.5 (9.82) and low Hg (8 µg/L), indicating this area is not part of the CBP. Therefore, this well was not sparged during Phase 2 and its target CO₂ was effectively set to zero.

3.3.3 Maximum Wellhead Pressures

Fractures can be generated in geologic formations if air or any other gas is injected at a pressure that exceeds the sum of the natural strength of the formation and the in-situ stresses present (Suthersan, 1997). The pressure required to fracture a consolidated geologic formation is a function of the cohesive or tensile strength of the formation and the pressure exerted by the weight of soil and water. Because the Satilla aquifer is primarily composed of non-cohesive sands, cohesive strength was conservatively assumed to be zero. Therefore, considering only the weight of the water and soil, the minimum pneumatic fracture initiation pressure, P_i is:

$$P_i > d_w(\gamma_w \phi + \gamma_{soil}(1 - \phi)) + (d_{tot} - d_w)\gamma_{soil}(1 - \phi) \quad (3-1)$$

where d_w is the depth of water (saturated thickness), d_{tot} is the total depth of soil, φ is the soil porosity, γ_w is the specific weight of water (62.4 lb/ft³) and γ_{soil} is the specific weight of soil.

Sparge wells (enumerated below in the tables as SWs) at the Site were screened at different intervals and therefore would have their own unique minimum pneumatic fracture initiation pressures. Table 3-4 through Table 3-6 provides calculated minimum pneumatic fracture initiation pressures for all sparge wells (Phase 1 through 3).

The calculations of P_i presented in Table 3-4 through Table 3-6 assumed a 5-ft unsaturated zone, porosity of 0.30, and a specific gravity of soil equal to 2.65 (specific weight of soil equal to 116 lb/ft³). The 5 ft of unsaturated zone provides a conservative estimate of P_i (the actual depth of the unsaturated zone varies from approximately 3 to 4 ft). There is also additional head loss from the well head to the base of the sparge well screen, resulting in lower effective pressures at the well screen. Therefore, actual field conditions at a particular sparge well would yield a slightly larger value of P_i , which could allow for slightly higher sparging pressures at the well head. During sparging implementation, pressure applied to individual sparge wells was gradually increased until a satisfactory flow was achieved or until pressures were no more than 2 to 3 psi of P_i .

Table 3-4: Calculated Minimum Pneumatic Fracture Initiation Pressure for Phase 1 Sparge Wells

Sparge Well	Top of Screen, d_{tot} (ft bgs)	Depth of water, d_w (ft)	P_i (psi)	Sparge Well	Top of Screen, d_{tot} (ft bgs)	Depth of water, d_w (ft)	P_i (psi)
SW-2	47.5	42.5	32.3	SW-34	42.0	37.0	28.4
SW-3	46.0	41.0	31.2	SW-35	42.0	37.0	28.4
SW-4	48.5	43.5	32.9	SW-36	47.0	42.0	31.9
SW-5	48.5	43.5	32.9	SW-37	49.0	44.0	33.3
SW-6	48.5	43.5	32.9	SW-38	49.5	44.5	33.6
SW-7	48.0	43.0	32.6	SW-39	49.5	44.5	33.6
SW-8	48.0	43.0	32.6	SW-40	50.0	45.0	34.0
SW-9	47.5	42.5	32.3	SW-41	48.5	43.5	32.9
SW-10	47.5	42.5	32.3	SW-42	49.5	44.5	33.6
SW-11	49.5	44.5	33.6	SW-43	46.0	41.0	31.2
SW-12	49.0	44.0	33.3	SW-44	47.0	42.0	31.9
SW-13	49.5	44.5	33.6	SW-45	42.0	37.0	28.4
SW-14	47.0	42.0	31.9	SW-46	42.0	37.0	28.4
SW-15	47.0	42.0	31.9	SW-47	44.0	39.0	29.8
SW-16	49.0	44.0	33.3	SW-48	45.0	40.0	30.5
SW-17	48.5	43.5	32.9	SW-49	50.5	45.5	34.3
SW-18	50.5	45.5	34.3	SW-50	49.0	44.0	33.3
SW-19	44.0	39.0	29.8	SW-51	50.0	45.0	34.0
SW-20	49.0	44.0	33.3	SW-52	49.5	44.5	33.6
SW-21	44.0	39.0	29.8	SW-53	46.5	41.5	31.6
SW-22	48.0	43.0	32.6	SW-54	42.0	37.0	28.4
SW-23	48.0	43.0	32.6	SW-55	40.5	35.5	27.4
SW-24	48.5	43.5	32.9	SW-56	45.5	40.5	30.9
SW-25	51.0	46.0	34.7	SW-57	46.0	41.0	31.2
SW-26	50.0	45.0	34.0	SW-58	49.0	44.0	33.3
SW-27	49.5	44.5	33.6	SW-59	49.5	44.5	33.6
SW-28	49.5	44.5	33.6	SW-60	45.5	40.5	30.9
SW-29	50.0	45.0	34.0	SW-61	47.0	42.0	31.9
SW-30	50.0	45.0	34.0	SW-62	45.0	40.0	30.5
SW-31	47.0	42.0	31.9	SW-63	47.6	42.6	32.3
SW-32	47.5	42.5	32.3	SW-64	50.5	45.5	34.3
SW-33	46.0	41.0	31.2	SW-65	48.0	43.0	32.6

Table 3-5: Calculated Minimum Pneumatic Fracture Initiation Pressure for Phase 2 Sparge Wells

Sparge Well	Top of Screen, d_{tot} (ft bgs)	Depth of water, d_w (ft)	P_i (psi)	Sparge Well	Top of Screen, d_{tot} (ft bgs)	Depth of water, d_w (ft)	P_i (psi)
SW-66	48	43	32.6	SW-106	49	44	33.3
SW-67	46.5	41.5	31.6	SW-107	51	46	34.7
SW-68	49	44	33.3	SW-108	48.75	43.75	33.1
SW-69	49	44	33.3	SW-109	49	44	33.3
SW-70	46.5	41.5	31.6	SW-110	49	44	33.3
SW-71	47.5	42.5	32.3	SW-111	46	41	31.2
SW-72	47	42	31.9	SW-112	43	38	29.1
SW-73	48	43	32.6	SW-113	42	37	28.4
SW-74	49	44	33.3	SW-114	45	40	30.5
SW-75	48	43	32.6	SW-115	47	42	31.9
SW-76	45.7	40.7	31.0	SW-116	46	41	31.2
SW-77	46	41	31.2	SW-117	45.5	40.5	30.9
SW-78	48	43	32.6	SW-118	44	39	29.8
SW-79	49.5	44.5	33.6	SW-119	45	40	30.5
SW-80	49.5	44.5	33.6	SW-120	50	45	34.0
SW-81	48.5	43.5	32.9	SW-121	48	43	32.6
SW-82	49	44	33.3	SW-122	50	45	34.0
SW-83	43.5	38.5	29.5	SW-123	43	38	29.1
SW-84	46.5	41.5	31.6	SW-124	44.5	39.5	30.2
SW-85	47.5	42.5	32.3	SW-125	46	41	31.2
SW-86	45	40	30.5	SW-126	46	41	31.2
SW-87	50	45	34.0	SW-127	48.5	43.5	32.9
SW-88	48	43	32.6	SW-128	47	42	31.9
SW-89	49	44	33.3	SW-129	46.5	41.5	31.6
SW-90	49	44	33.3	SW-130	47	42	31.9
SW-91	48.5	43.5	32.9	SW-131	48.5	43.5	32.9
SW-92	43	38	29.1	SW-132	48.5	43.5	32.9
SW-93	46	41	31.2	SW-133	49	44	33.3
SW-94	44	39	29.8	SW-134	47.5	42.5	32.3
SW-95	42.5	37.5	28.8	SW-135	46	41	31.2
SW-96	41	36	27.8	SW-136	46	41	31.2
SW-97	49	44	33.3	SW-137	48	43	32.6
SW-98	49	44	33.3	SW-138	48	43	32.6
SW-99	50	45	34.0	SW-139	48.5	43.5	32.9
SW-100	49	44	33.3	SW-140	49.5	44.5	33.6
SW-101	42.5	37.5	28.8	SW-141	49	44	33.3
SW-102	43	38	29.1	SW-142	49	44	33.3
SW-103	42	37	28.4	SW-143	48	43	32.6
SW-104	41.5	36.5	28.1	SW-144	47	42	31.9
SW-105	44	39	29.8	SW-145	48	43	32.6

Table 3-6: Calculated Minimum Pneumatic Fracture Initiation Pressure for Phase 3 Sparge Wells

Sparge Well	Top of Screen, d_{tot} (ft bgs)	Depth of water, d_w (ft)	P_i (psi)	Sparge Well	Top of Screen, d_{tot} (ft bgs)	Depth of water, d_w (ft)	P_i (psi)
SW-146	46.5	41.5	31.6	SW-178	50	45	34.0
SW-147	46	41	31.2	SW-179	47	42	31.9
SW-148	46	41	31.2	SW-180	47	42	31.9
SW-149	47.4	42.4	32.2	SW-181	48.5	43.5	32.9
SW-150	46.5	41.5	31.6	SW-182	50	45	34.0
SW-151	44.5	39.5	30.2	SW-183	50	45	34.0
SW-152	45.5	40.5	30.9	SW-184	52	47	35.4
SW-153	47.5	42.5	32.3	SW-185	49.5	44.5	33.6
SW-154	45.5	40.5	30.9	SW-186	51.25	46.25	34.9
SW-155	47	42	31.9	SW-187	50	45	34.0
SW-156	47	42	31.9	SW-188	50	45	34.0
SW-157	46.5	41.5	31.6	SW-189	46	41	31.2
SW-158	47.5	42.5	32.3	SW-190	49	44	33.3
SW-159	46.5	41.5	31.6	SW-191	50	45	34.0
SW-160	47	42	31.9	SW-192	48.5	43.5	32.9
SW-161	48	43	32.6	SW-193	52.5	47.5	35.7
SW-162	47.5	42.5	32.3	SW-194	47	42	31.9
SW-163	47	42	31.9	SW-195	48.5	43.5	32.9
SW-164	49.5	44.5	33.6	SW-196	47.5	42.5	32.3
SW-165	47.5	42.5	32.3	SW-197	45	40	30.5
SW-166	47	42	31.9	SW-198	46	41	31.2
SW-167	48.5	43.5	32.9	SW-199	47	42	31.9
SW-168	46	41	31.2	SW-200	51	46	34.7
SW-169	46.5	41.5	31.6	SW-201	53	48	36.1
SW-170	48.5	43.5	32.9	SW-202	45.5	40.5	30.9
SW-171	47.5	42.5	32.3	SW-203	46	41	31.2
SW-172	47	42	31.9	SW-204	45.5	40.5	30.9
SW-173	47	42	31.9	SW-205	46	41	31.2
SW-174	47	42	31.9	SW-206	45.5	40.5	30.9
SW-175	48	43	32.6	SW-207	50	45	34.0
SW-176	45	40	30.5	SW-208	50	45	34.0
SW-177	50	45	34.0	SW-209	48	43	32.6

3.3.4 Sequence of Operations

Phase 3 sparging was initiated on October 10, 2015 and continued through April 7, 2016, with sparge operations suspended over the 2-week holiday period between December 23, 2015 and January 4, 2016. After the post-sparge sampling event, remaining CO₂ in storage was sparged into select sparge wells from May 11, 2016 through May 17, 2016.

Newly installed sparge wells were commissioned prior to Phase 3 sparging operations commenced. The sparge well commissioning process entailed gradually applying pressure to individual wells to

understand well-specific pressure / flow relationships, while at the same time making observations and collecting shallow groundwater elevations to understand the potential for groundwater mounding and surfacing. Initial guidelines for sparge well sequencing included the following:

- Two sparge wells per distribution panel would be sparged simultaneously, initially for approximately 4-hr periods.
- Extended duration sparging would be applied to areas with high alkalinity.
- During sparging, water levels were monitored in piezometers. Superposition of mounding was not significant and groundwater levels generally never rose to within 1 ft of the ground surface.

3.3.5 Sparge Well and Monitoring Well Maintenance

Basic maintenance was required on sparge wells and monitoring wells. Notably, two sparge wells (SW-36 and SW-141) were damaged while clearing vegetation and were repaired using a PVC coupling.

3.4 Field Measurements During Sparging

During sparging of a well, measurements of temperature, flow rate and pressure were made at the distribution panel. Pressure was measured at a gauge just downstream of the rotameter. These measurements were collected at periodic intervals, typically every half hour during normal sparging operations. The collected measurements were recorded in electronic spreadsheets stored on waterproof tablets and copied to a master spreadsheet for calculation of total mass sparged (see Section 3.5). A summary of these measurements for each sparge well is provided in Appendix E.

3.5 Measurement and Calculation of Flowrates and CO₂ Mass

The flow rate of gas to the sparge well was read from a distribution panel rotameter upstream of the well head. Rotameters report accurate flow rates only when the operating conditions (temperature and pressure) are the same as the conditions under which the rotameter was calibrated. When operating and calibration conditions differ, flow readings from a rotameter must be corrected. The rotameter correction equation for gases is:

$$Q^* (\text{scfm}) = Q_{\text{rotameter}} \sqrt{\left(\frac{T_{\text{std}}}{T_{\text{act}}}\right) \left(\frac{P_{\text{act}}}{P_{\text{std}}}\right)} \quad (3-2)$$

where $Q_{\text{rotameter}}$ is the flow reading from the rotameter, Q^* is the gas volumetric flow rate (in scfm), P_{act} is the actual pressure (in psia), T_{act} is the actual temperature (in °R), P_{std} is the standard pressure (in psia), T_{std} is the standard temperature (530 °R) of the rotameter correction. Rotameters installed on the permanent

system were calibrated for carbon dioxide, so an additional specific gravity correction was not required. For CO₂ sparging, Equation 3-2 becomes:

$$Q^* (\text{scfm CO}_2) = Q_{\text{rotameter}} \sqrt{\left(\frac{530^\circ\text{R}}{T_{\text{act}} + 460}\right) \left(\frac{P_{\text{act}} + 14.7}{14.7 \text{ psi}}\right)} \quad (3-3)$$

The rotameter used for the portable system was not calibrated for CO₂. Therefore, a specific gravity correction was also required:

$$Q^* (\text{scfm CO}_2) = Q_{\text{rotameter}} \sqrt{\left(\frac{530^\circ\text{R}}{T_{\text{act}} + 460}\right) \left(\frac{P_{\text{act}} + 14.7}{14.7 \text{ psi}}\right) \left(\frac{1}{\text{SG}}\right)} \quad (3-4)$$

The mass of CO₂ injected into sparge wells was calculated by numerically integrating the flow versus time data for each sparge well (Appendix E). The trapezoidal method of integration was employed and the equation used to calculate the mass for each well is shown below:

$$M_{\text{sparged}} = \rho_{\text{gas}}^* \int Q^* dt \approx \rho_{\text{gas}}^* \sum \bar{Q}^* \Delta t \quad (3-5)$$

where ρ_{gas}^* represents the density of carbon dioxide equal to 0.1144 lb/ft³ at standard temperature and pressure (70 °F and 14.7 psi). A correction factor (C_F) of 1.136 was used to modify Equation 3-4 to more accurately account for the mass to each sparge well (Mutch Associates and Parsons, 2014):

$$Q^* (\text{scfm CO}_2) = C_F Q_{\text{rotameter}} \sqrt{\left(\frac{530^\circ\text{R}}{T_{\text{act}} + 460}\right) \left(\frac{P_{\text{act}} + 14.7}{14.7 \text{ psi}}\right)} \quad (3-6)$$

3.6 Piezometric Surface and Groundwater Table

The 20 shallow piezometers installed prior to Phase 2, the 15 piezometers installed prior to Phase 1, and the shallow Satilla monitoring wells were checked for water level rise via manual measurement with an electronic water level meter.

A total of ten pressure transducers (Solinst, Levelogger) were installed in Satilla monitoring wells. The transducers were used to obtain information on piezometric surface rise in the deep Satilla and shallow groundwater level rise throughout the sparging program. Five transducers were placed within the sparging footprint: MW-352B, MW-501B, MW-513B, MW-515B and MW-519A. Five transducers were placed to the west of the sparging footprint: MW-112C, MW-353B, MW-503B, MW-507B and MW-508B. Each transducer was set to a designated depth within the well and securely affixed to prevent any movement.

Automatic data loggers connected to each transducer were synchronized for time and programmed to record water levels at 5-minute intervals during the CO₂ sparging period. All transducers were installed by October 30th, 2015. Transducers installed in MW-508B and MW-513B failed about a month into Phase 3 therefore and data was available only through November 29, 2015. The remaining eight transducers collected data through March 16, 2016.

3.7 Geoprobe Sampling

Geoprobe sampling of deep Satilla groundwater was performed in January 2016 to delineate the extent of high pH groundwater northwest of SW-152 and SW-159. The details of this work are described in the Technical memorandum entitled *Supplemental Geoprobe Investigation, LCP Chemicals Site, Brunswick GA* (Mutch Associates, 2015a) dated December 22, 2015. The work was approved by EPA on January 15, 2016. The memo proposed a minimum of two samples and a maximum of four samples (at locations denoted TL-01 through TL-04 on Figure 3-5) in cleared areas as determined by a 2015 tree-line survey, accessible with a Geoprobe rig. As per the memo, one additional sample would be collected beyond the initial sample if the pH measured in the field was above 10.5. The results for the first two locations GP-36 and GP-37 were 10.44 and 10.48, respectively (Figure 3-5). Since these were less than 10.5, additional sampling was not performed. The groundwater sampling purge logs for these samples are provided in Appendix C.

Post-sparg Geoprobe sampling was performed to provide groundwater quality data after sparging in the southern area. The sampling program consisted of 18 locations along the pre-sparg Geoprobe transects to allow for pre-sparg and post-sparg comparisons of water quality. Also, the locations were placed at varying distances from sparg wells to provide information on the radius of influence in the southern area. Each location was sampled using a 4-ft screen set approximately 1 ft above the estimated depth to sandstone, with the exception of GP-50a and GP-51a, where the screen was set approximately 3 ft above the estimated depth to sandstone. Samples were measured for pH in the field and field-filtered using a 0.45 µm filter. The samples were then sent to TestAmerica Laboratories in Savannah, GA for analysis of dissolved Hg using EPA method SW-846 7470A.

3.8 Air Monitoring

Ambient air monitoring during sparging consisted of grab sample monitoring for carbon dioxide, oxygen, and hydrogen sulfide using a MultiRae IR Plus multi-gas meter, and for Hg using a Jerome Model 431X meter. The air space near representative sparg wells was sampled over the course of the program. Typically, measurements were collected at the sparg well heads and approximately 10 ft north, south, east, and west of the sparg wells (i.e., five locations per sparg well).

Approximately 174 sampling events (five locations each) were conducted over the course of the program; sample results are reported on the forms provided in Appendix F; a summary of the results is provided below (Table 3-7). No exceedances of action levels for the four air constituents monitored were observed.

Table 3-7: Summary of Air Monitoring Results

Air Constituent	Units	Action Level	Minimum Observed Level	Maximum Observed Level	Notes
CO ₂	ppmv	2,500	440	800	
O ₂	% by volume	> 19.5% and < 22.0%	20.9	20.9	
H ₂ S	ppmv	10	0.0	3.8	Only 1 sample above 0.0
Hg	mg/m ³	0.05	0.000	0.004	Only 7 samples above 0.000

4 RESULTS OF PHASE 3 SPARGING

4.1 Sparge Well Flow Rates and Total CO₂ Mass

4.1.1 CO₂ Flow Rates

The first two weeks of sparging operations involved a “break-in” period where CO₂ was injected into each Phase 3 sparge well for the first time. The initial injections provided critical information on injection pressures required to achieve flow. All Phase 3 wells had measureable flow at moderate pressures (30 to 35 psi gauge) indicating that they were functional sparge wells.

The average flow rates for each Phase 3 sparge well varied from 10.8 scfm (SW-193) to 46.8 scfm (SW-205) (Figure 4-1). The average flow rate for all Phase 3 sparge wells was 24.1 scfm. Average flow rates for Phase 1 and Phase 2 wells sparged during Phase 3 were similar (Figure 4-2).

4.1.2 CO₂ Total Mass

The total amount of CO₂ injected during Phase 3 was 1,156,000 lb. By comparison, 783,000 lb was sparged during Phase 1 and 1,521,000 lb was sparged during Phase 2. The sparged mass and target mass of CO₂ for each of the Phase 3 sparge wells are shown on Figure 4-3. As described earlier in Section 3.2.2, sparge well target masses ranged from 8,000 to 32,000 lb of CO₂. All Phase 3 sparge wells received their target mass. The sparged mass and target mass of CO₂ for each Phase 1 and Phase 2 sparge well sparged during Phase 3 are shown in Figure 4-4. All Phase 1 and Phase 2 sparge wells received their target mass. As described earlier, all Phase 2 sparge wells in the southern area (SW-126 through SW-145) received at least 2,000 lb during Phase 3 of CO₂ to treat high pH groundwater that may have moved into the zone of influence of a Phase 2 well during sparging of Phase 3 sparge wells and to replenish residual saturation of CO₂.

4.1.3 CO₂ Mass Balance

A system-wide mass balance was performed for Phase 3 to determine the total mass of CO₂ injected and to verify the masses injected into each sparge well. The total mass delivered to the Site must be equal to the sum of the CO₂ mass sparged, the CO₂ left in inventory and any major losses during start-up:

$$M_{\text{delivered}} = M_{\text{sparged}} + M_{\text{inventory}} + M_{\text{major losses}} \quad (4-1)$$

The total mass delivered to the Site by Airgas was 1,208,000 lb (604 tons). The storage tanks had approximately 5,000 lb (2.5 tons) remaining in inventory at conclusion of sparging. During system start-up, the tank telemetry system indicated that approximately 15,000 lb (7.5 tons) was used, effectively setting

$M_{\text{major losses}}$. The mass of CO₂ sparged, calculated using numerical integration of the flow versus time data (Equation 3-5), was 1,156,000 (578 tons). The mass balance error was calculated according to:

$$\text{Error \%} = \frac{(M_{\text{sparged}} + M_{\text{inventory}} + M_{\text{major losses}}) - M_{\text{delivered}}}{M_{\text{delivered}}} \times 100\% \quad (4-2)$$

The mass balance error calculated using this approach was -2.6%:

$$\text{Error \%} = \frac{(1,156,000 + 15,000 + 5,000) - 1,208,000}{1,208,000} \times 100\% = -2.6\% \quad (4-3)$$

This is an acceptable level of error for this type of system mass balance.

4.2 Effect of Sparging on pH

4.2.1 Pre-sparge pH

Deep Satilla Monitoring and Extraction Wells

Groundwater monitoring results from deep Satilla monitoring and extraction wells from 2011-2012 (Figure 4-5) serve as an appropriate pre-sparge baseline for the CBP. The CBP during this period was characterized as consistently having pH between 10.5 and 12.0 (Table 4-1). As described in Section 2.1, the Phase 1 sparging footprint was determined via interpolation of these pH values.

The pH in groundwater sampled from deep Satilla monitoring locations prior to the start of Phase 3 sparging is shown in Figure 4-6. In general, pH within the sparging footprint varied from 6.18 (MW-357B) to 11.71 (MW-516B).

Sparge Wells

Pre-sparge pH in Phase 3 sparge wells (Figure 4-7) varied from 5.94 (SW-173) to 11.98 (SW-205). Many of the Phase 3 sparge wells in the southern area had a pre-sparge pH less than 10.5 as a result of the Phase 2 effort. A composite map showing pH in deep Satilla monitoring locations (monitoring wells, extraction wells, sparge wells) is provided as Figure 4-8. This map displays all information that was known about the pH of deep Satilla groundwater prior to the start of Phase 3 sparging.

Mid Satilla Monitoring Wells

The pH in the mid Satilla aquifer beneath the Site is generally lower than the deep Satilla, consistent with the conceptual model of the CBP as a dense plume at the base of the aquifer. Mid Satilla pH within the sparging footprint from 2011-2012 (Figure 4-9) varied from 6.38 (MW-501A) to 11.60 (MW-514A).

Only MW-512A and MW-514A had pH greater than 10.5, indicating that these wells are screened at elevations that is representative of the CBP. After Phase 1, the pH in MW-512A and MW-514A had decreased to 8.59 and 6.86, respectively (Mutch Associates and Parsons, 2014). Prior to Phase 3, mid Satilla wells had pH ranging from 5.77 (MW-513A) to 8.53 (MW-517A) (Figure 4-10).

4.2.2 pH Monitoring Results During Sparging

As described earlier, pH was measured in various monitoring wells and extraction wells throughout the sparging footprint during all phases of CO₂ sparging. Field pH measurements versus time for all 31 deep Satilla monitoring points within 50 ft of a sparge well are shown in Figures 4-11 through 4-21. As illustrated below for MW-512B and MW-519B, each chart shows the 2011-2012 pre-sparging pH. The first point for each phase represents the pre-sparging baseline for that particular phase. Likewise, the last point for each phase represents the post-sparging monitoring for that phase.

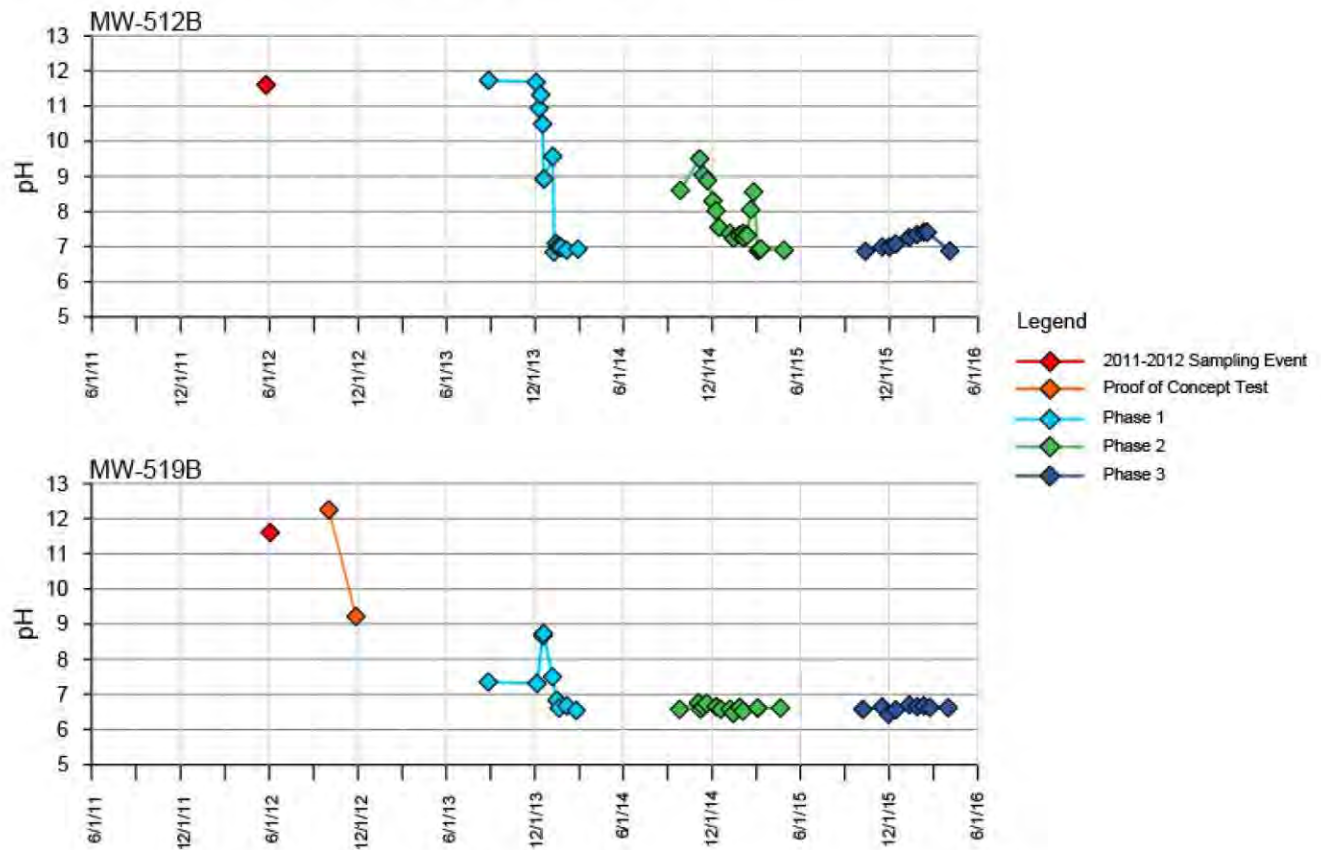

Above: pH as a function of time in MW-512B and MW-519B for all three sparging phases.

The pH versus time for all 31 deep Satilla monitoring points generally show that pH has decreased in the deep Satilla aquifer during CO₂ sparging with minimal rebound. For example, MW-501B (Figure 4-

12) decreased from pH 11.7 to pH 6.8 during Phase 1 of sparging and has stayed between 6.7 and 7.0 through all of the subsequent sparging phases. Approximately half of deep Satilla monitoring points (14 out of 31) have exhibited similar behavior: EW-1, EW-2, EW-9, EW-11, MW-1C, MW-2C, MW-357A, MW-501B, MW-502B, MW-504B, MW-505B, MW-517B, MW-518B and MW-519B. A few monitoring points have shown gradual decreases in pH throughout all three phases: EW-3, EW-8 and MW-511B. A relatively small number of monitoring points have shown evidence of rebound, but the pH decreased again during subsequent sparging phases. Examples of monitoring points exhibiting this behavior include EW-4, EW-6, EW-10, MW-105C, MW-115C, MW-352B, MW-357B, MW-512B and MW-515B. MW-513B and MW-516B are the only deep Satilla monitoring points that have not exhibited a decrease in pH as a result of CO₂ sparging. MW-513B and MW-516B had post-Phase 3 sparging pH values of 10.62 and 11.83, respectively.

SW-196 and SW-197 were installed specifically to address high pH water on the northwestern edge of the Phase 1 sparging footprint near MW-510B and EW-5 (Figure 2-2). Therefore, MW-510B and EW-5 were useful monitoring points for assessing the effectiveness of sparging in this area. The pH versus time for MW-510B (Figure 4-21) shows a decreased in pH from 10.9 to approximately 7.0 within a few weeks of sparging during Phase 3. Likewise, the pH in EW-5 decreased toward the end of Phase 3, finishing with a pH of 9.41 (Figure 4-15).

The pH of MW-352B (Figure 4-12) decreased from pH 12.00 to 9.55 during Phase 2, only to rebound back to pH 11.39 at the end of Phase 2. The nearest sparge well to MW-352B is SW-123, which was sparged during Phase 2 and was located on the edge of the Phase 2 sparge well network. The pH rebound observed in MW-352B was likely caused by westward movement of untreated groundwater east of SW-123. As discussed in Section 2.1.1, a “sparge column” of ten sparge wells (SW-200 to SW-209) was installed and sparged during Phase 3 to address the area along the eastern edge of the sparging footprint. In addition, SW-123 was sparged during Phase 3 to re-treat the area near MW-352B. This approach proved to be successful, as the pH in MW-352B slowly decreased throughout Phase 3 to a final value of 8.68.

The pH of MW-513B (Figure 4-13) decreased from 11.34 to 6.51 after Phase 1, with a rebound to pH 9.30 by the start of Phase 2. During Phase 2, the pH was highly variable ranging from 7.42 to 11.69. During Phase 3, the pH of MW-513B dropped below 10.5 on numerous occasions with a final pH of 10.62 at the end of Phase 3.

Field pH versus time for deep Satilla monitoring wells west of the sparging footprint are provided in Figures 4-22 through 4-24. The pH in these wells has been relatively stable over time with MW-508B as the only exception. The pH in MW-508B varied from 9.0 to 10.0 from June 2012 through June 2015

(the end of Phase 2). However, at the start of Phase 3, the pH was substantially lower (7.83) and decreased even lower by the end of Phase 3 (7.10). This well is reasonably close (approximately 70 ft) to the edge of the sparging footprint, however there were no sparge wells running in the vicinity of MW-508B during Phase 3. It is likely that water treated via CO₂ sparging has travelled west towards MW-508B since the end of Phase 2.

4.2.3 Post-sparge pH Results

As discussed in Section 3.1, pH was measured in the field in all deep monitoring and extraction wells, and select mid Satilla monitoring wells within the sparging footprint at the end of Phase 3. In addition, field pH was measured in select sparge wells and in discrete groundwater samples collected from the deep Satilla aquifer via Geoprobe in the southern area of the Site.

Deep Satilla Monitoring and Extraction Wells

A summary of the changes in pH in deep Satilla monitoring and extraction wells within the Phase 1 footprint is provided in Table 4-1. Post-Phase 3 pH results are also shown below and on Figure 4-25 in plan view for deep Satilla monitoring and extraction wells. After Phase 3, nearly all (28 out of 30; 93%) of deep Satilla monitoring and extraction wells within the sparging footprint had a pH of less than 10.5. Most of these monitoring points had pH less than 7.5 (24 out of 30; 80%). The mean pH in these same deep Satilla monitoring points decreased from 11.32 (2011-2012) to 7.11 as a result of CO₂ sparging (Table 4-1). The median pH decreased from 11.44 to 6.57.

As mentioned in the previous section, the only deep Satilla monitoring points within the sparging footprint above pH 10.5 at the end of Phase 3 were MW-516B (pH 11.83) and MW-513B (pH 10.62). MW-513B has had its pH driven down to near-neutral at various points during sparging, but the final pH was marginally above 10.5 at the end of Phase 3.

Table 4-1: Summary of Pre- and Post-Sparge pH in Deep Satilla Monitoring Points within the Phase 1 Sparging Footprint

Monitoring Point	Pre-sparge 2011-2012	Pre-Phase 1	Post-Phase 1	Pre-Phase 2	Post-Phase 2	Pre-Phase 3	Post-Phase 3	Δ pH ^(e)
EW-1	11.33 (a)	11.28	6.27	6.50	6.32	6.29	6.22	-5.11
EW-2	11.20 (a)	10.50	6.57	7.26	6.47	6.35	6.39	-4.81
EW-3	11.78 (a)	11.01	9.84	9.79	7.01	6.65	6.53	-5.25
EW-4	11.73 (a)	11.53	7.01	8.50	9.69	6.81	6.74	-4.99
EW-5	11.02 (a)	11.21	10.74	9.06	11.22	10.73	9.41	-1.61
EW-6	11.49 (a)	11.75	7.41	6.96	6.78	8.68	6.97	-4.52
EW-8	10.88 (a)	10.91	9.09	7.52	6.59	6.49	6.61	-4.27
EW-9	11.44 (a)	11.14	6.73	7.30	6.68	6.55	6.60	-4.84
EW-10	11.23 (a)	11.42	7.34	7.41	7.67	8.92	NS	-----
EW-11	11.72 (a)	8.20	6.49	6.85 (d)	6.39	6.41	6.53	-5.19
MW-105C	11.35	11.08	6.68	10.4	6.38	6.19	6.38	-4.97
MW-115C	12.00 (c)	10.70 (c)	6.68	9.83	8.63	8.91	8.44	-3.56
MW-1C	12.24 (b)	8.98	6.64	6.61	6.55	6.64	6.46	-5.78
MW-2C	11.10 (b)	8.71	6.49	6.70	6.65	6.63	6.57	-4.53
MW-352B	11.96	11.53	12.89	12.00	11.39	11.48	8.68	-3.28
MW-357A	11.20 (c)	10.20	6.54	6.79	6.46	6.48	6.51	-4.69
MW-357B	11.60 (c)	11.08	8.82	8.78	6.20	6.18	6.37	-5.23
MW-501B	11.64	11.30 (c)	6.81	6.79	6.73	6.63	6.80	-4.84
MW-502B	11.53	10.90 (c)	6.45	6.44	6.50	6.37	6.40	-5.13
MW-504B	11.18	11.20	6.49	6.62	6.40	6.60	6.47	-4.71
MW-505B	10.94	10.04	6.85	6.91	6.59	6.53	6.57	-4.37
MW-510B	9.57	11.33	10.20	9.28	10.90	10.62	6.56	-3.01
MW-511B	11.93	12.20	9.81	8.66	6.58	6.45	6.55	-5.38
MW-512B	11.60 (c)	11.73	6.93	8.60	6.90	6.87	6.88	-4.72
MW-513B	11.52	11.34	6.51	9.30	11.69	11.62	10.62	-0.90
MW-514B	11.62	10.37	6.31	6.77	6.11	7.00	6.05	-5.57
MW-515B	10.15	11.24	8.80	9.39	8.66	8.56	7.54	-2.61
MW-516B	11.20 (c)	11.30 (c)	11.48	11.62	11.60	11.71	11.83	0.63
MW-517B	10.65	9.81	6.48	6.57	6.54	6.49	6.38	-4.27
MW-518B	10.60	10.87	6.39	6.82	6.53	6.36	6.50	-4.10
MW-519B	11.60	7.35	6.54	6.57	6.61	6.57	6.62	-4.98
Mean:	11.32	10.72	7.69	8.02	7.59	7.57	7.11	-4.22
Median:	11.44	11.08	6.73	7.30	6.61	6.63	6.57	-4.88

(a) Extraction well pH from Aug/Sept 2011

(b) Indicates pH value was measured in September 2012 prior to the Proof of Concept Test

(c) Lab pH was more consistent with historical data therefore it was substituted for field pH

(d) Indicates value was collected shortly after the start of Phase 2 sparging

(e) Δ pH calculated using Pre-sparge (2011-2012) and Post-Phase 3 pH data

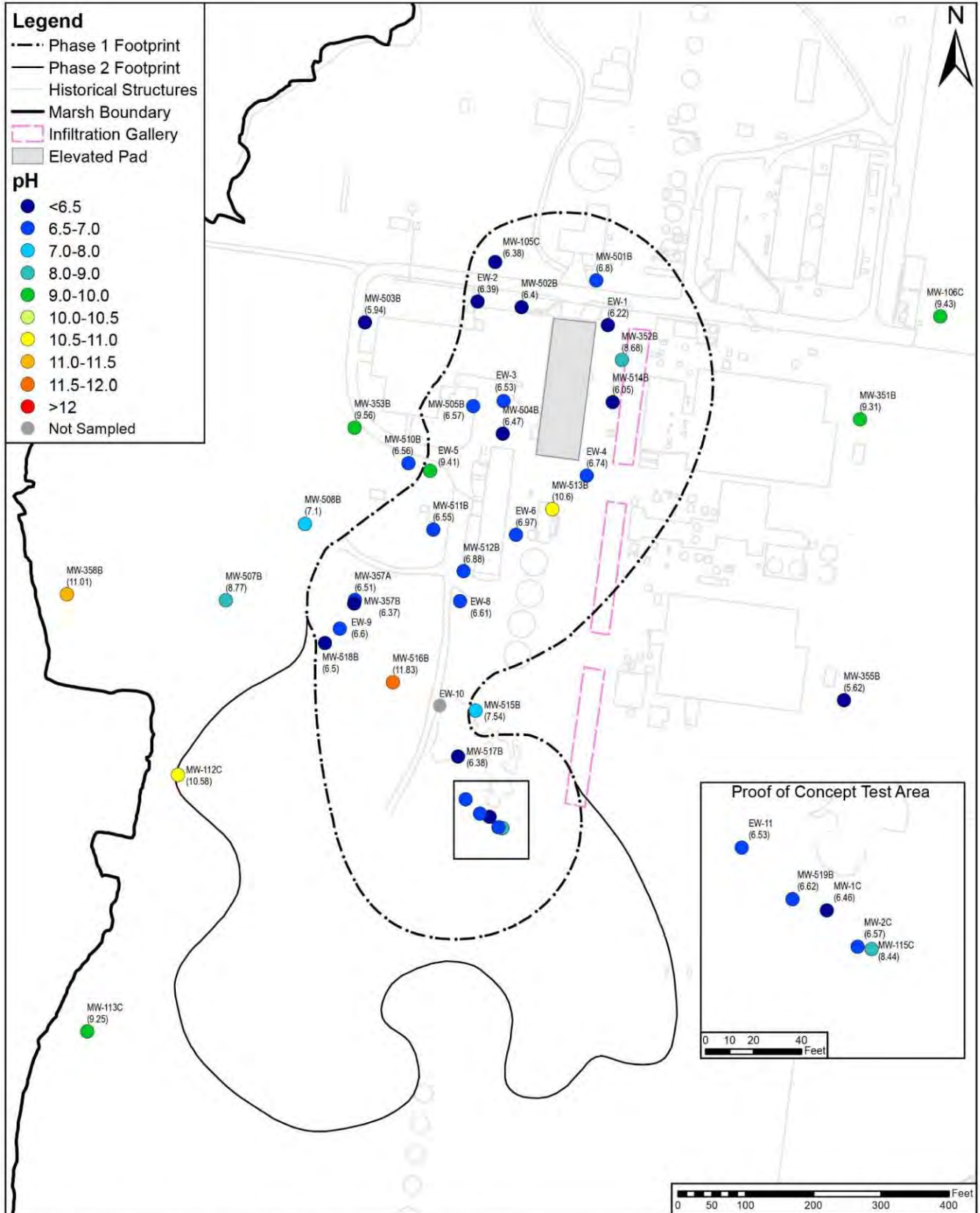

Above: Post-Phase 3 pH for deep Satilla monitoring wells and extraction wells.

Sparge Wells

Post-Phase 3 pH values in all 209 sparge wells are shown in Figure 4-26. The mean and median pH in these wells were 6.89 and 6.71, respectively. A large majority (191 out of 209 or 91%) of these wells showed pH less than 7.5. A small number of sparge wells had a pH greater than 7.5 (e.g. SW-6, SW-18, SW-73, SW-106). The sparge well with the highest pH (10.05) was measured in SW-49, a Phase 1 sparge well on the southeastern edge of the sparging footprint. SW-49 is in close proximity to the former pH 10.5 contour, and thus the pH of groundwater near SW-49 is expected to increase as the natural westward hydraulic gradient in the Satilla aquifer brings slightly-alkaline, non-sparged groundwater into the area.

Since there was an inventory of CO₂ (approximately 79,000 lb) in storage following planned Phase 3 sparging, sparge wells with pH greater than 8.5 received a relatively small amount (2,000 to 6,000 lb) of supplemental CO₂. SW-113 and SW-73 were resampled for pH one week after the conclusion of supplemental sparging. The pH was less than 7.0 in both sparge wells (SW-113: pH 6.68, SW-73: pH 6.89). Based on previous experience at this Site, the pH in all of the other sparge wells that received supplemental CO₂ is also expected to be between 6.5 to 7.0.

The pH in all deep Satilla monitoring locations (monitoring wells, extraction wells, and sparge wells) is shown in Figure 4-27. The two monitoring locations with pH greater than 10.5 (MW-513B and MW-516B) are isolated areas with neutral pH water on all sides. MW-513B (pH 10.62) is located within a triangle formed by SW-52, SW-59 and SW-110, all of which had neutral pH at the end of Phase 3 (pH 7.07 to 7.39). Likewise, MW-516B (pH 11.83) is located within a rectangle formed by SW-11, SW-20, SW-75 and SW-82, all which had neutral pH at the end of Phase 3 (pH 6.65 to 6.82).

Groundwater Sampled via Geoprobe

As described in Section 3.1.2, a total of 18 discrete groundwater samples were collected via Geoprobe from the base of the Satilla aquifer in the southern area of the Site at the end of Phase 3. The pH and dissolved Hg concentrations from these samples are summarized in Table 4-2, along with groundwater pH and Hg results from Geoprobe sampling performed at the end of Phase 2. Note that the data in Table 4-2 is sorted by distance from Geoprobe sampling location to the nearest sparge well. The pH at these Geoprobe locations are shown in Figure 4-28 along with 33-ft radii extended outward from southern area Phase 2 and 3 sparge wells. Post-Phase 2 results showed that the pH was between 6.86 and 7.82 at distances between 15 and 25 ft. At distances 30 ft or greater, pH was between 7.14 and 11.67, with several locations with pH less than 10.0. These results were consistent with the observed average ROI of 33 ft within the Phase 1 footprint.

Table 4-2: Summary of Post-Sparge Geoprobe Sampling of Deep Satilla Groundwater in the Southern Area

Geoprobe ID	Distance from GP to nearest SW (ft)	Nearest SW	pH ^(a)	Hg (µg/L) ^(b)
<i>Post-Phase 2</i>				
GP-26	14.9	SW-129	6.86	13
GP-22	15.0	SW-130	7.82	33
GP-31	20.0	SW-138	7.09	17
GP-23	20.0	SW-131	7.04	7
GP-21	25.1	SW-133	6.77	21
GP-25	29.9	SW-127	7.14	26
GP-35	30.0	SW-143	10.69	5.7
GP-27A	30.0	SW-126	10.56	45
GP-27	34.9	SW-126	11.54	41
GP-28	35.1	SW-139	10.39	13
GP-34	53.6	SW-143	11.49	14
GP-29	54.7	SW-140	11.27	37
GP-24	56.0	SW-127	9.32	62
GP-30	61.9	SW-140	11.67	170
GP-20	68.4	SW-7	9.13	75
GP-32	69.2	SW-48	9.46	2.9
<i>Post-Phase 3</i>				
GP-39	15.0	SW-190	8.43	25
GP-42	15.2	SW-185	6.60	15
GP-40	19.0	SW-188	6.91	4
GP-48	19.8	SW-155	7.16	33
GP-43	20.0	SW-138	5.91	0.43
GP-44	24.6	SW-176	9.92	79
GP-52	25.0	SW-166	8.54	3.1
GP-51	26.0	SW-129	11.85	120
GP-51A	26.4	SW-129	9.60	32
GP-49	26.6	SW-131	9.25	42
GP-46	29.4	SW-160	9.73	60
GP-41	29.6	SW-188	9.08	33
GP-45	34.3	SW-169	9.50	75
GP-47	35.0	SW-150	9.80	55
GP-50A	38.5	SW-151	9.28	120
GP-50	39.8	SW-151	11.18	45
GP-38	39.9	SW-189	10.62	46

(a) Results are for field-measured pH

(b) Results are for dissolved Hg

Post-Phase 3 results show that pH in groundwater collected by Geoprobe was generally less than 10.5. The only exceptions were GP-38, GP-50, and GP-51. Near the GP-50 (pH 11.18) and GP-51 (pH 11.85) sampling locations, additional Geoprobe samples were collected with a screen elevation that was 2 ft higher. These groundwater samples, denoted GP-50A and GP-51A, had a considerably lower pH of 9.28 and 9.60, respectively. These results indicate that there is a sharp vertical pH gradient at these locations and that most of the water above the base of the Satilla aquifer near GP-50 and GP-51 was treated by sparging.

Mid Satilla Monitoring Wells

Results for post-sparging pH in mid Satilla monitoring points are shown in Figure 4-29. The pH in mid Satilla wells within the sparging footprint varied from 6.18 (MW-513A) to 9.13 (MW-517A). Mid Satilla wells have generally decreased in pH throughout all three phases. Most notably, MW-514A decreased from pH 11.6 in 2012 (Figure 4-9) to 6.37 after Phase 3 (Figure 4-29). Groundwater in the mid and shallow Satilla is easier to treat than the deep Satilla with CO₂ sparging because of inverted cone that originates at the well screen of a sparge well.

Table 4-3: Summary of pH Data Collected in Monitoring Wells Screened in the Coosawhatchie A/B Aquifer

Monitoring Well	May 31, 2012	Jan 15, 2014	Feb 21-22, 2014	Dec 11, 2014	Apr 8-9, 2015	Apr 13-14, 2016
MW-115D	10.22	10.10	10.14	10.17	9.99	10.13
MW-352D	6.35	6.80	6.84	6.81	6.78	8.00
MW-360D	9.92	10.09	10.15	10.46	10.34	10.28
HW-East2	6.58	-	6.38	6.44	6.44	6.45
HW-East3	6.63	-	6.32	6.65	6.50	6.98
HW-East5	9.00	-	7.13	7.18	7.29	7.51

4.2.4 Effect of Sparging on Coosawhatchie pH

The effect of sparging on pH in the Coosawhatchie A/B aquifer was assessed by monitoring six wells screened in this aquifer. MW-352D, MW-115D, MW-360D, HW-East2, HW-East3, HW-East5 were sampled near the end of the Phase 3 sparging effort on April 13-14, 2016. This data, along with measurements made prior to the start of sparging (May 31, 2012), which serve as a pre-sparging baseline, and measurements made during Phase 1 and 2 sparging, are summarized in Table 4-3. Most of the Coosawhatchie monitoring wells have been relatively stable since the start of sparging. The only monitoring well to increase is MW-352D which increased from 6.35 to 8.00 from May 2012 to April 2016. However, this is only marginally higher than the pH 7.27 measured in May 2010. HW-East5 decreased from 9.00 to 7.51. The relatively small changes in pH in Coosawhatchie wells indicate that sparging in the deep Satilla has not had a significant effect on water quality in the Coosawhatchie A/B aquifer. This is an expected result given the separation of these units by the variably-cemented sandstone.

4.3 Effect of Sparging on Silica, TDS and Specific Gravity

The effect of sparging on silica, TDS and specific gravity is discussed in following subsections using pre- and post-sparging concentration summary statistics (Table 4-4) and demonstrating discussion of the changes in concentration within the deep Satilla aquifer before and after sparging.

4.3.1 Effect of Sparging on Silica

Silica concentrations in the deep Satilla measured through all phases of CO₂ sparging are summarized in Table 4-4. Prior to Phase 1 sparging, silica values within the sparging footprint ranged from 30 mg/L (MW-357A) to 17,000 mg/L (MW-352B). High silica areas generally greater than 1,000 mg/L were on the eastern edge of the sparging footprint. A low silica area existed near the Proof of Concept Test, as a result of prior sparging in this area. After Phase 1, most deep Satilla monitoring points showed a decrease in silica to less than 200 mg/L as a result of the lower pH. As discussed in the Phase 1 Report, dissolved silica concentrations decrease with decreasing pH to maintain equilibrium with amorphous SiO₂. Pre-and post-sparging aquifer testing during Phase 1 showed no sharp loss of aquifer transmissivity. Therefore, silica precipitation does not appear to cause a loss in aquifer permeability.

Table 4-4: Summary Statistics for Constituents in Deep Satilla Monitoring Points

Chemical Constituent	Sample Period	Sample Size (n)	Mean ^(a)	Median	Standard Deviation ^(b)
Total Dissolved Solids, TDS (mg/L)	Pre-Phase 1	28	16,000	12,000	13,000
	Post-Phase 1	29	13,000	11,000	8,100
	Pre-Phase 2	24	13,000	11,000	8,100
	Post-Phase 2	27	14,000	9,700	12,000
	Pre-Phase 3	29	16,000	12,000	13,000
	Post-Phase 3	30	13,000	9,800	9,400
Silica, Si (mg/L as SiO ₂)	Pre-Phase 1	28	1,400	400	3,300
	Post-Phase 1	29	760	75	2,600
	Pre-Phase 2	24	720	120	2,400
	Post-Phase 2	27	930	93	2,400
	Pre-Phase 3	29	1,000	130	2,400
	Post-Phase 3	30	310	120	830

(a) When measured values were below the MDL (i.e. “U” qualified), half the MDL was used in calculation of the mean.

(b) In several cases the standard deviation is greater than the median and mean of the dataset. A standard deviation calculated from the data can be larger than the mean or median when the distribution of observations covers a wide-range of values and follows a skew-positive probability distribution. This was the case for all of the Si datasets.

Silica concentrations in most deep Satilla monitoring points that were low at the end of the Phase 1 were relatively unchanged at the start of Phase 3. The largest decreases in silica over the course of Phase 3 were observed for EW-5 (2,000 to 250 mg/L) and MW-352B (10,000 to 280 mg/L). Overall, changes in silica concentrations parallel changes in pH measured in deep Satilla monitoring points. At the end of Phase 3, the only two wells that had silica concentrations greater than 1,000 mg/L (MW-513B and MW-516B) had pH greater than 10.5. Overall, mean silica has decreased from 1,400 to 310 mg/L from pre-Phase 1 to post-Phase 3 (Table 4-4). Median silica decreased from 400 to 120 mg/L.

4.3.2 Effect of Sparging on Total Dissolved Solids

TDS measured in deep Satilla monitoring points throughout all phases of CO₂ sparging are summarized in Table 4-4. Prior to Phase 1 sparging, TDS in deep Satilla monitoring points within the sparging footprint ranged from 2,600 mg/L (MW-105C) to 56,000 mg/L (MW-352B), with a mean of 16,000 mg/L (n = 28) and median of 12,000 mg/L. Note that MW-352B had the highest TDS and silica prior to Phase 1 (see Section 4.3.1). TDS concentrations appear to have large spatial variability; monitoring points showing the highest concentrations are often near points with relatively low concentrations. For example, MW-352B (56,000 mg/L) is neighbored by EW-1 (3,500 mg/L) and MW-514B (5,300 mg/L).

Pre-Phase 3 TDS in deep Satilla monitoring points ranged from 3,800 mg/L (MW-514B) to 59,000 mg/L (MW-352B), with a mean of 16,000 mg/L (n = 29) and median of 12,000 mg/L. Post-Phase 3 TDS in deep Satilla monitoring points ranged from 3,000 mg/L (EW-4) to 41,000 mg/L (EW-5). Overall, mean and median TDS in deep Satilla monitoring points within the sparging footprint decreased from pre-Phase 1 to post-Phase 3. The mean TDS decreased from 16,000 mg/L to 13,000 mg/L, for a percent decrease of 19%. The median TDS decreased from 12,000 mg/L to 9,800 mg/L, for a percent decrease of 18%.

There are numerous geochemical reactions occurring during CO₂ sparging which can affect TDS. The reaction which appears to have the largest effect on TDS is precipitation of amorphous silica. As discussed in Section 4.3.1, mean silica concentrations decreased from 1,400 to 300 mg/L, resulting in a decrease of 1,100 mg/L. Silica results from the laboratory were reported in units of “mg/L as SiO₂.” Since dissolved silica exists in natural waters predominantly as silicic acid (Si(OH)₄), the decrease in dissolved solids due to loss of silica is even larger (1,800 mg/L), and accounts for more than 50% of the mean decrease in TDS (3,000 mg/L). Amorphous silica is also capable of adsorbing and co-precipitating other cations such as iron, aluminum, manganese, and magnesium. Thus, most of the loss in TDS is probably the result of silica precipitation. CO₂ sparging is not expected to have a large effect on sodium and chloride which are the major components of TDS within the CBP, and these ions generally behave conservatively (i.e. do not precipitate or adsorb). CO₂ sparging is expected to increase the concentrations of bicarbonate ion which is produced when high pH water is neutralized by CO₂.

4.3.3 Effect of Sparging on Specific Gravity

Specific gravity (SG) of a liquid is defined as the ratio of density of the liquid (ρ) to a reference density (ρ_{ref}), usually taken to be the density of pure water at 4°C ($\rho_{\text{ref}} = 1.0000 \text{ g/mL}$):

$$SG = \frac{\rho}{\rho_{\text{ref}}} \quad (4-4)$$

As a result of this definition, the density of a liquid is linearly proportional to its specific gravity. The presence of dissolved solids in water has the effect of increasing its density. Since all groundwaters possess some level of dissolved solids, groundwater samples collected from the Site would be expected to have a specific gravity greater than 1.0000.

Measured specific gravity values from Phases 1, 2 and 3 are summarized in Table 4-5. The majority of specific gravity measurements recorded during Phase 1 were between 1.01 and 1.02. A more precise field hydrometer was used to record specific gravity during Phase 2 and Phase 3 sparging. The effect of CO₂ sparging on SG is shown graphically in Figure 4-30 where the change in specific gravity (Δ SG) from pre-Phase 1 to post-Phase 3 is plotted against the change in pH (Δ pH) over the same time period. Negative Δ SG values indicate a decrease in specific gravity over the course of CO₂ sparging. The Δ SG value was negative for 6 out of 7 monitoring wells which showed a decrease in pH of more than 2 units. This supports the conclusion that CO₂ sparging decreased the measured SG.

Measuring accurate SG in the field after CO₂ sparging is difficult because of the presence of CO₂ in the water. CO₂ exsolvates creating a flow of gas which partially fluidizes the field hydrometer. The gas flow pushes the hydrometer upward creating a slight positive bias (i.e. larger SG) and can prevent the hydrometer from reaching a stable level in the water. In addition, dissolved CO₂ nucleates as small gas bubbles on the outer wall of the hydrometer glass proving an artificial buoyancy which can create a positive bias.

To address this potential bias and to expand the number of wells used to evaluate changes in groundwater SG, measured TDS values were used to estimate SG for all deep Satilla monitoring points within the sparging footprint. Figure 4-31 shows a linear relationship between the TDS and SG (plotted as SG – 1) for deep Satilla groundwater using data collected in 1995-1996 as part of the RI (blue circles) and data collected during Phase 3 (green circles). Both the RI and Phase 3 data fall on a straight line, but there is larger variation in the Phase 3 data, likely due to the complications of measuring SG in the presence of CO₂. The dashed blue line on Figure 4-31 represents a linear regression using the 1995-1996 RI data only, to avoid influence from CO₂ sparging on measured SG. The slope of this relationship (7.54×10^{-7}) matches very closely a published relationship from Kohfahl et al. (2015) for NaCl-dominated natural waters (6.4×10^{-7}). Therefore, the site-specific pre-sparg slope (7.54×10^{-7}) was used to calculate SG from TDS for all deep Satilla monitoring points within the sparging footprint.

Table 4-5: Pre- and Post-Sparge Specific Gravity

Monitoring Point	Pre-Phase 1	Post-Phase 1	Pre-Phase 2	Post-Phase 2	Pre-Phase 3	Post-Phase 3	Δ SG ^(c)
MW-105C	NM ^(a)	1.01	1.0045	1.0050	1.0055	1.0065	-
MW-112C	NM	NM ^(b)	1.0225	1.0280	1.0225	1.0205	-
MW-113C	NM	NM ^(b)	1.0240	1.0250	1.0250	1.0245	-
MW-115C	1.03	1.045	1.0240	1.0220	1.0220	1.0215	-0.01
MW-501B	NM ^(a)	1.02	1.0105	1.0160	1.0110	1.0115	-
MW-502B	1.02	1.023	1.0050	1.0075	1.0048	1.0065	-0.01
MW-503B	1.00	1.01	1.0005	1.0025	1.0025	1.0060	0.01
MW-504B	1.02	1.02	1.0155	1.0070	1.0050	1.0060	-0.01
MW-511B	1.02	1.02	1.0150	1.0110	1.0125	1.0075	-0.01
MW-512B	1.025	1.01	1.0130	1.0180	1.0175	1.0160	-0.009
MW-513B	1.01	1.02	1.0120	1.0165	1.0175	1.0290	+0.02
MW-514B	1.00	1.01	1.0040	1.0045	1.0015	1.0040	0.00
MW-516B	1.02	1.02	1.0180	1.0180	1.0155	1.0165	0.00
MW-518B	1.03	1.02	1.0085	1.0050	1.0070	1.0070	-0.02
Mean:	1.02	1.02	1.0126	1.0133	1.0121	1.0131	
Median:	1.02	1.02	1.0125	1.0135	1.0118	1.0095	

(a) MW-105C and MW-501B were inadvertently not measured (NM) in the field for the Pre-Phase 1 sample period.

(b) MW-112C and MW-113C were not measured in the field for Phase 1.

(c) Δ SG was calculated from Pre-Phase 1 to Post-Phase 3.

The effect of CO₂ sparging on the computed SG is shown graphically in Figure 4-32 where the change in specific gravity (Δ SG) from pre-Phase 1 to post-Phase 3 is plotted against the change in pH (Δ pH) over the same time period. The majority of points (20 out of 30) have a negative Δ SG value indicating a decrease in computed SG over the course of CO₂ sparging. The mean computed SG decreased from 1.013 to 1.010 (n = 30) and the median computed SG decreased from 1.009 to 1.007 (n = 30).

The decrease in median computed SG from pre-Phase 1 to post-Phase 3 was statistically significant at the 95% confidence level. Since neither the pre-Phase 1 or post-Phase 3 computed SG data were normally distributed, the non-parametric Wilcoxon signed-rank test was used to test for differences in median SG between pre-Phase 1 and post-Phase 3. The assumptions of this test are that the data are paired and that each pair is chosen randomly and independently. Both of these assumptions are met. The null hypothesis of this test is that the median SG values of the pre-Phase 1 and post-Phase 3 are equal. The alternative hypothesis is that the post-Phase 3 median is less than the pre-Phase 1 median. The p-value resulting from the Wilcoxon signed-rank test was 0.026 which is less than the criteria for rejecting the null hypothesis at 95% confidence for a one-tailed hypothesis test (0.050). We can therefore state with greater than 95% confidence that the median post-Phase 3 computed SG is lower than the median pre-Phase 1 computed SG.

4.4 Effect of Sparging on Mercury

4.4.1 Pre-Sparge Mercury

Deep Satilla Monitoring and Extraction Wells

Groundwater monitoring results for total Hg in the deep Satilla from 2011-2012 (Figure 4-33) serve as an appropriate pre-sparge baseline for the CBP because sparging began in late 2013 as part of the Proof of Concept Test. During this period, deep Satilla groundwater within the Phase 1 sparging footprint exhibited total Hg concentrations between 36 (MW-516B) and 2,530 µg/L (EW-6) with a mean of 270 µg/L (Table 4-6). In general, groundwater in the northern part of the Phase 1 footprint had the highest Hg concentrations, typically greater than 200 µg/L. Concentrations in the southern part of the Phase 1 footprint typically had concentrations approximately between 100 and 200 µg/L.

Pre-Phase 3 results for total Hg in deep Satilla monitoring locations are shown in Figure 4-34. Deep Satilla total Hg concentrations within the entire sparging footprint ranged from 0.68 µg/L (J-qualified, EW-11) to 500 µg/L (MW-352B). Many monitoring locations (21 out of 30) had mercury concentrations below 20 µg/L reflective of reductions in Hg concentrations as a result of Phase 1 and 2 sparging.

Sparge Wells

Pre-Phase 3 dissolved Hg measurements for Phase 2 and Phase 3 sparge wells are shown on Figure 4-35 and summarized in Table 4-7. Dissolved Hg in Phase 2 sparge wells are generally low as a result of prior treatment, ranging from < 0.2 µg/L (SW-141) to 71 µg/L (SW-118). Dissolved Hg in Phase 3 sparge wells ranged from 2.0 µg/L (SW-165) to 830 µg/L (SW-198) with many locations along the eastern edge of the northern area (e.g. SW-198, SW-203, SW-205, SW-207 and SW-209) at concentrations greater than 400 µg/L. These wells had not been sparged in prior phases. The dissolved Hg concentrations are consistent with those measured in nearby deep Satilla monitoring points (e.g. MW-352B and EW-6) prior to the start of Phase 1.

Table 4-6: Summary of Pre- and Post-Sparge Hg in Deep Satilla Monitoring Wells Within the Sparging Footprint

Monitoring Point	Pre-Sparge 2011-2012 ^(a)	Pre-Phase 1	Post-Phase 1	Pre-Phase 2	Post-Phase 2	Pre-Phase 3	Post-Phase 3	Hg Change (µg/L)	Hg % Change from 2011-2012
EW-1	68	50	0.53	3.8	2.1	3.3	1.1	-67	-98.4%
EW-2	119	60	6.7	NA ^(b)	2.7	3.6	3.2	-116	-97.3%
EW-3	384	NA ^(b)	71	170	40	23	15	-369	-96.1%
EW-4	219	NA ^(b)	20	NA ^(b)	36	25	7	-212	-96.8%
EW-5	433	300	180	NA ^(b)	75 ^(a)	350	140	-293	-67.7%
EW-6	2,530	430	180	NA ^(b)	41	78	84	-2446	-96.7%
EW-8	92	48	2.7	1.6	NA ^(b)	1.3	1.7	-90	-98.2%
EW-9	160	120	NA ^(b)	NA ^(b)	NA ^(b)	16	4.7	-155	-97.1%
EW-10	101	68	35	32	NA ^(b)	NA ^(b)	NA ^(b)	NA	NA
EW-11	160	48	3	NA ^(b)	0.95	0.68 J	0.72	-159	-99.6%
MW-105C	60	58	2.4	1.6	0.95	1.1	1.1	-59	-98.2%
MW-115C	98	62	19	26	24	13	5.9	-92	-94.0%
MW-1C	110 ^(c)	43	11	3.7	2.9	1.2	1.2	-109	-98.9%
MW-2C	110 ^(c)	49	34	5.3	6.4	3.8	1	-109	-99.1%
MW-352B	1,080	690	260	390	470 ^(a)	500	90	-990	-91.7%
MW-357A	111	71	4.1	50	13	12	1	-110	-99.1%
MW-357B	178	180	5.7	45	2.2	1.1	1.9	-176	-98.9%
MW-501B	39	48	13	25	28	17	3.3	-36	-91.5%
MW-502B	98	120	4.4	18	2.9	2.2	0.91	-109	-99.1%
MW-504B	392	320	7.7	6	2.4	1.1	1.1	-391	-99.7%
MW-505B	301	53	32	32	14	17	33	-268	-89.0%
MW-510B ^(d)	135	97	72	130	40	96 ^(e)	18	-117	-86.7%
MW-511B	280	160	82	31	1.9	12	3	-277	-98.9%
MW-512B	202	85	30	120	17	12	11	-191	-94.6%
MW-513B	342	12	11	78	270 ^(a)	270	460	118	34.5%
MW-514B	77	40	4.1	26	3.7	98	1.9	-75	-97.5%
MW-515B	56	30	10	30	10	11	9.5	-47	-83.0%
MW-516B	36	34	37	64	55 ^(a)	50	160	124	344%
MW-517B	128	92	14	6.9	16	13	22	-106	-82.8%
MW-518B	124	53	4.8	4.5	13	12	7.4	-117	-94.0%
MW-519B	152	31	15	7.7	4.1	2.9	3.1	-149	-98.0%
Mean:	270	119	39	52	43	55	36	-234	-86.7%
Median:	128	60	14	26	13	12	4.0	-124	-96.9%

(a) EW data from September 2011 sampling event, MW data from May/June 2012 sampling event unless indicated otherwise

(b) Sample result not representative of deep Satilla groundwater (see Section 3.1.1)

(c) Indicates Hg value was measured in September 2012 prior to the Proof of Concept Test

(d) MW-510B was added to this list as part of Phase 3 since it is now within the sparging footprint

(e) MW-510B Pre-Phase 3 measured dissolved (field filtered) Mercury

Table 4-7: Summary of Pre- and Post-Sparge Dissolved Hg in Deep Satilla Sparge Wells within the Sparging Footprint

<i>Phase 2 Sparge Wells</i>						
Sparge Well	Pre-Phase 2	Post-Phase 2	Pre-Phase 3	Post-Phase 3	Hg Change (µg/L)	Hg % Change
SW-68	54	0.59	1.0	3.3	-51	-93.9%
SW-71	110	63	29	6.5	-104	-94.1%
SW-73	120	20	53	1.7	-118	-98.6%
SW-87	13	7.3	5.5	5.5	-7.5	-57.7%
SW-106	150	4.6	4.1	3.0	-147	-98.0%
SW-108	790	56	73	91	-699	-88.5%
SW-113	620	12	40	10	-610	-98.4%
SW-115	240	2.9	6.0	0.41	-240	-99.8%
SW-124	7.5	4.8	8.8	27	20	260%
SW-128	28	11	25	9.1	-19	-67.5%
SW-134	66	23	30	12	-54	-81.8%
SW-135	31	23	16	10	-21	-67.7%
SW-136	76	23	21	21	-55	-72.4%
SW-137	63	17	8.0	3.2	-60	-94.9%
SW-141	1.7	0.2 U	0.2 U	4.6	2.9	171%
SW-145	24	0.28	1.0 U	0.58	-23	-97.6%
Mean^(a):	150	17	20	13	-137	-91.3%

<i>Phase 3 Sparge Wells</i>						
Sparge Well	Pre-Phase 2	Post-Phase 2	Pre-Phase 3	Post-Phase 3	Hg Change (µg/L)	Hg % Change
SW-154	-	-	59	5.8	-53	-90.2%
SW-165	-	-	2.0	0.52	-1.5	-74.0%
SW-172	-	-	78	8.0	-70	-89.7%
SW-191	-	-	7.0	0.2 U	-6.8	-97.1%
SW-198	-	-	830	11	-819	-98.7%
SW-201	-	-	48	38	-10	-20.8%
SW-203	-	-	670	5.2	-665	-99.2%
SW-205	-	-	500	0.64	-499	-99.9%
SW-207	-	-	410	20	390	-95.1%
SW-209	-	-	730	1.0 U	-729	-99.9%
Mean^(a):	-	-	333	9	-324	-97.3%

(a) When measured values were below the MDL (i.e. "U" qualified), half the MDL was used in calculation of the mean.

Mid Satilla Monitoring Wells

Total Hg concentrations in mid Satilla monitoring wells from 2011-2012 (Figure 4-36) had concentrations between 0.64 µg/L and 522 µg/L. Hg concentrations in mid Satilla monitoring wells are generally lower than in the deep Satilla. The highest concentrations were observed in MW-352A (522 µg/L) and MW-514A (503 µg/L), located west of the former cell buildings and east of the elevated pad. These wells are in the same area as MW-352B, which had very high Hg concentrations in the deep Satilla (discussed above).

4.4.2 Post-Sparge Mercury

As discussed in Section 3.1, total Hg was measured in all deep monitoring and extraction wells, and select mid Satilla monitoring wells within the sparging footprint at the end of Phase 3. In addition, dissolved Hg was measured in select sparge wells and in groundwater samples collected from the deep Satilla aquifer via Geoprobe in the southern area of the Site.

Deep Satilla Monitoring and Extraction Wells

Post-sparge (Phase 3) total Hg concentrations for deep Satilla monitoring wells and extraction wells are shown in Figure 4-37. The majority (23 out of 30)⁶ of monitoring points within the Phase 1 footprint showed Hg concentrations less than 20 µg/L. About one-third of all points (11 out of 30) had Hg concentrations less than 2.0 µg/L. Deep Satilla monitoring and extraction well Hg results are summarized in Table 4-6. Overall, nearly all monitoring points (28 out of 30) in the deep Satilla has lower total Hg when compared to 2011-2012 levels as a result of CO₂ sparging. The mean Hg concentration in all monitoring points was lowered from 270 to 36 µg/L, a percent decrease of 87%. The median Hg concentration in all monitoring points was lowered from 128 to 4.0 µg/L, a percent decrease of 97%.

The decrease in Hg in deep Satilla monitoring points is shown graphically in Figure 4-38 in the form of box plot using the data from Table 4-6. The boundary of the box closest to zero indicates the 25th percentile, a line within the box marks the median, and the boundary of the box farthest from zero indicates the 75th percentile. The error bars above and below the box indicate the 95th and 5th percentiles values, respectively. The box plot illustrates the decreasing trend of median Hg concentrations from pre-Phase 1 through post-Phase 3.

Sparge Wells

Post-Phase 3 dissolved Hg concentrations in Phase 2 and Phase 3 sparge wells are shown on Figure 4-39 and are summarized in Table 4-7. The mean dissolved Hg in Phase 2 sparge wells has decreased from 150 µg/L (Pre-Phase 2) to 13 µg/L (Post-Phase 3). There are many examples of continued and sustained decreases in dissolved Hg with time (e.g. SW-71, SW-115, SW-136, SW-134, SW-137). Many Phase 2 sparge wells (11 out of 16) were less than or equal to 20 µg/L at the end of Phase 3 sparging. Dissolved Hg concentrations decreased in all ten Phase 3 sparge wells that were sampled (Table 4-7). The mean Hg

⁶ As discussed in Section 3.1.1, groundwater collected from EW-10 at the end of Phase 3 had a lower specific conductance than historical values for the CBP and was considered non-representative of deep Satilla groundwater. Hence, the number of deep Satilla monitoring points considered within the sparging footprint decreased from 31 to 30.

concentration in Phase 3 sparge wells was lowered from 333 to 9 µg/L, a percent decrease of 97%. Percent decreases of greater than 90% were observed in 7 out of 10 Phase 3 sparge wells. The mean dissolved Hg concentration in the Phase 2 and 3 sparge wells (taken collectively) after Phase 3 was 11 µg/L. A summary of post-Phase 3 Hg in all deep Satilla monitoring wells, extraction wells and sparge wells is shown below and in Figure 4-40.

Groundwater Sampled via Geoprobe

Post-phase 3 dissolved Hg results for discrete groundwater samples collected via Geoprobe in the southern area of the Site are shown on Figure 4-41 and summarized on Table 4-8 and Table 4-9. Concentrations ranged from 0.43 µg/L (GP-43) to 120 µg/L (GP-51 and GP-50a). The mean and median dissolved Hg concentrations were 46 and 42 µg/L, respectively. Pre-Phase 2 Geoprobe results serve as an appropriate baseline for comparison since sparging in the southern area began during Phase 2. The average dissolved Hg concentrations in groundwater collected via Geoprobe decreased from 99 µg/L to 45 µg/L as a result of sparging in the southern area, a decrease of 55%.

Dissolved Hg results from pre-Phase 2 and post-Phase 2 are also shown on Figure 4-41 (grey symbols) to examine the effect of CO₂ sparging on Hg concentrations at co-located Geoprobe pairs. This information is also summarized in Table 4-8 for clarity. In general, specific locations that showed improvement in pH to near-neutral (e.g. GP-06/GP-25, GP-12/GP-42) levels also showed a substantial decrease in dissolved Hg.

Relationship Between pH and Hg in Deep Satilla Groundwater

As discussed earlier, Hg concentrations generally decreased as the pH was lowered to near-neutral as a result of CO₂ sparging. The Proof of Concept Test showed that Hg concentrations decreased sharply when the pH was lowered below pH 8.0 (Mutch Associates and Parsons, 2013b). A similar dependence was present in the Phase 1 data except that there was inherently more variability because the entire CBP was represented (top panel of Figure 4-42). The post-sparge Phase 3 relationship between Hg and pH for deep Satilla monitoring locations is shown in the bottom panel of Figure 4-42. The Hg versus pH relationship is not as evident in the Phase 3 data as it was in the Phase 1 data. This is because most of the Phase 3 groundwater samples were between pH 6.0 and 7.5 as a result of sparging whereas the Phase 1 pre- and post-sparging data covered a much wider pH range (6 to 12). Overall, Hg concentrations are expected to continue to decrease at recently-sparged locations because of the kinetic effect of Hg immobilization after sparging has ended (Mutch Associates and Parsons, 2013c).

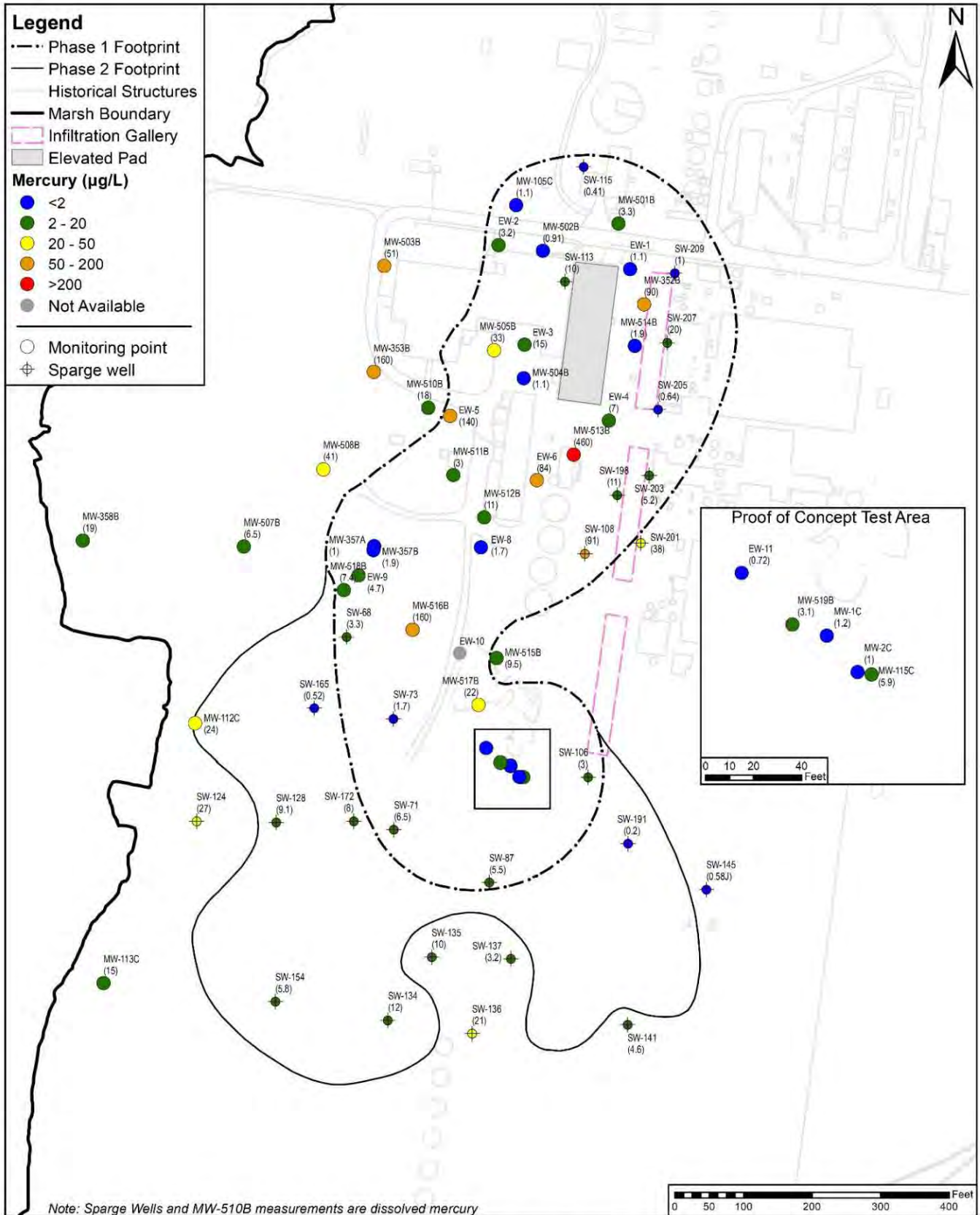

Above: Post-Phase 3 Hg for deep Satilla monitoring, extraction and sparge wells.

Table 4-8: Summary of Pre- and Post-Sparge Dissolved Hg in Co-located Pairs of Geoprobe Points within the Sparging Footprint

<i>Phase 2</i>			
Geoprobe pair	Pre-Phase 2	Post-Phase 2	Hg Change (µg/L)
GP-01/GP-20	N/A	75	N/A
GP-02/GP-21	180	21	-159
GP-03/GP-22	110	33	-77
GP-04/GP-23	160	7.0	-153
GP-05/GP-24	220	62	-158
GP-06/GP-25	78	26	-52
GP-09/GP-26	74	13	-61
GP-10/GP-27	42	41 ^(a)	-1
GP-12/GP-29	160	37 ^(a)	-123
GP-13/GP-30	25	170 ^(a)	+145
GP-14/GP-31	33	17	-16
GP-17/GP-35	5.0	5.7 ^(a)	+0.7
Mean:	99	42	-57

<i>Phase 3</i>			
Geoprobe pair	Pre-Phase 3	Post-Phase 3	Hg Change (µg/L)
GP-12/GP-42	150	15	-135
GP-17/GP-38	5.0	46 ^(b)	+41
GP-14/GP-43	33	0.43	-33
GP-6/GP-47	78	55	-23
GP-10/GP-50A ^c	42	120 ^(b) (45)	+78
GP-9/GP-51A ^d	74	32 ^(b) (120)	-42
Mean:	64	45	-19

- (a) Indicates pH was above 10.5 at the end of Phase 2
 (b) Indicates pH was above 10.5 at the end of Phase 3
 (c) GP-50 value shown in parenthesis (base of Satilla)
 (d) GP-51 value shown in parenthesis (base of Satilla)

Table 4-9: Summary of Mercury Concentrations in the Deep Satilla

Monitoring Points							
		Sample Size (n)	Mean	Standard Deviation	Median	Average Difference ^(a)	Average % Change ^(a)
Total Hg (µg/L)	2011-2012	31	270	463	128	-234	-87%
	Pre-Phase 1	29	119	150	60		
	Post-Phase 1	30	39	63	14		
	Pre-Phase 2	25	52	83	26		
	Post-Phase 2	27	43	100	13		
	Pre-Phase 3	30	55	115	12		
	Post-Phase 3	30	36	90	4.0		
Selected Sparge Wells							
		Sample Size (n)	Mean	Standard Deviation	Median	Average Difference ^(b)	Average % Change ^(b)
Dissolved Hg (µg/L)	Pre-Phase 2	16	150	230	64	-324	-97%
	Post-Phase 2	16	17	19	12		
	Pre-Phase 3	10	333	332	244		
	Post-Phase 3	10	9.0	11	5.5		
Geoprobe Locations							
		Sample Size (n)	Mean	Standard Deviation	Median	Average Difference ^(b)	Average % Change ^(b)
Dissolved Hg (µg/L)	Pre-Phase 2	15	83	68	74	-37	-44%
	Post-Phase 2	16	36	41	24		
	Post-Phase 3	17	46	36	42		

(a) Average difference and average percent change for monitoring points was calculated using mean value from 2011-2012 and mean value from post-Phase 3.

(b) Average difference and average percent change for sparge wells and Geoprobe locations was calculated using mean value from pre-Phase 2 and mean value from post-Phase 3.

The CBP is generally a sulfide-rich, reducing environment. Dissolved Hg speciation in the presence of sulfide is dominated by: complexes with sulfide such as HgHS^- , HgS_2^{2-} ; complexes with polysulfides such as $\text{Hg}(\text{S}_x)_2^{2-}$ and HgS_xOH^- ; complexes with thiol groups present on dissolved organic matter (DOM); and $\text{HgS}(\text{s})$ precipitated as metacinnabar or cinnabar (Skylberg, 2008). The geochemical conceptual model for Hg within the CBP is discussed in the RI (GeoSyntec Consultants, 1997) and in the Proof of Concept Test Final Report (Mutch Associates and Parsons, 2013b). Solubility of Hg in the presence of sulfide generally decreases with decreasing pH as a result of precipitation of Hg sulfide, $\text{HgS}(\text{s})$ (Jay et al., 2000).

Mid Satilla Monitoring Wells

Post-sparge total Hg concentrations for the mid Satilla are shown in plan view in Figure 4-43. Concentrations ranged from 2.3 µg/L to 550 µg/L with more than half of concentrations less than 20 µg/L. In general, Hg concentrations in the mid Satilla continue to decrease with each sparging event. For example, MW-352A and MW-514A, the two mid Satilla monitoring wells with the highest pre-Phase 1 Hg

concentrations (both were $\geq 300 \mu\text{g/L}$), showed large decreases after Phase 1 to $11 \mu\text{g/L}$ and $47 \mu\text{g/L}$, respectively. After Phase 2, these two wells had concentrations of $3.3 \mu\text{g/L}$ and $3.2 \mu\text{g/L}$, respectively. At the end of Phase 3, Hg at these locations are even lower at $2.2 \mu\text{g/L}$ and $2.3 \mu\text{g/L}$, respectively. Since, water collected from MW-513A during low-flow sampling had a turbidity greater than 50 NTU, a filtered and unfiltered sample were collected for Hg in accordance with the work plan (Mutch Associates and Parsons, 2013a). The filtered sample showed a dissolved Hg of $29 \mu\text{g/L}$, consistent with the low pH of 6.18 measured at this location. The unfiltered sample had a total Hg of $550 \mu\text{g/L}$, indicating that a large fraction of the total Hg has been immobilized on the soil solids.

4.4.3 Historical pH and Mercury Concentrations Versus Time

The historical pH Hg concentrations values for wells MW-519B and MW-115C, and EW-6 and EW-11 are shown in Figures 4-44 and 4-45, respectively. As discussed above, a significant reduction in Hg concentration is expected when groundwater reaches a neutral pH. The plots show that Hg concentrations continue to decline or remain stable over time as groundwater maintains a neutral pH. For example, MW-519B (Figure 4-44) shows a steady linear decrease in Hg concentration from the Proof of Concept Test through to the end of Phase 2. Hg concentrations in MW-519B have now stabilized at approximately $3 \mu\text{g/L}$. The historical plot of MW-115C (Figure 4-44) shows that the reduction in Hg concentration due to lowering the pH is not immediately reversible when a slight rise in pH occurs. The Proof of Concept Test, Phase 1 and Phase 2 sparging influenced the pH of groundwater near MW-115C. As expected, Hg concentrations decreased. However, when the pH increased slightly after Phase 2, the Hg concentrations remained at lower levels and did not rebound. This suggests that Hg reductions are not quickly reversible. Similarly, EW-6 ($84 \mu\text{g/L}$) and EW-11 ($0.72 \mu\text{g/L}$) (Figure 4-45) show sustained reductions in Hg concentrations since reaching a neutral pH. EW-6 is noteworthy because concentrations were at or above $1,000 \mu\text{g/L}$ for a long time and as high as $2,530 \mu\text{g/L}$ in September 2011.

4.5 Effect of Sparging on Piezometric Surfaces

Similar to the Proof of Concept Test and the previous two phases of sparging, the piezometric surface in the deep Satilla Aquifer and the groundwater table in the Satilla Aquifer were influenced during sparging. The mounding of the groundwater table in the Satilla, as observed in the hydrograph of PZ-63, is shown in Figure 4-46. The water elevation in PZ-63 represents the piezometric surface 5 to 7 ft below the water table, not the water table itself. As expected, the water elevation in PZ-63 fluctuated as a function of flow rate and radial distance to nearby operating sparge wells. After a sparge event was initiated, the water level in the piezometer increased quickly, reaching a peak of 1 to 3 ft above the original water elevation approximately 4 hours after the start of sparging. Once sparging concludes, it takes approximately 8 hours

for the water level to return to the pre-sparging water elevation. A detailed description of this process accompanied with figures is available in the Phase 1 Report (Mutch Associates and Parsons, 2014).

The water levels in the 35 shallow piezometers on site were checked periodically while sparging into the accompanying sparge wells. The northern portion of the Site adjacent to the access road has been particularly sensitive to daylighting of shallow groundwater because the elevation of the road was low relative to the ground, and the high density of the sparge network in the northern area. The sparging procedures were adjusted throughout Phase 3 to shorten sparging durations in the northern portion of the Site in an effort to minimize or preclude additional instances of the groundwater table surfacing on the road. The long-term effect of sparging on the groundwater table was an increase in water level elevation during sparging, followed by a gradual return to pre-sparging levels (e.g. PZ-63).

As was the case during the previous phases, the piezometric surface in the deep Satilla monitoring wells within the sparge footprint was strongly influenced by sparging. The piezometric surface changed as a function of sparge well flow rates and radial distance from the sparge well. During Phase 3, five monitoring wells within the Phase 1 footprint were outfitted with transducers (MW-352B, MW-501B, MW-513B, MW-515B, and MW-519B) and five monitoring wells (MW-353B, MW-503B, MW-507B, MW-508B, MW-112C) outside the sparging footprint recorded the piezometric surface throughout the sparging program. Hydrographs for MW-515B and MW-112C are provided in Figure 4-47, and all hydrographs for these monitoring wells are provided in Appendix G. The general behavior of the piezometric surface in a deep Satilla monitoring well under the influence of sparging is as follows: the piezometric surface increased in a matter of minutes after sparging began and steadily increased with the sparge flow rate throughout the sparging event. Near the end of the sparge period, the piezometric surface reached a maximum value. The piezometric surface declined immediately after sparging ended, often to a lower elevation than pre-sparging. The water level then returned to pre-sparging conditions approximately 8 hours after sparging ended. A detailed description of this process accompanied with figures is available in the Phase 1 Report (Mutch Associates and Parsons, 2014).

Table 4-10: Difference in Water Levels in Selected Well Pairs

	North End of Site	Center of Site	South End of Site
Historical Period	MW-501B to MW-503B (347 feet apart)	MW-513B to MW-508B (366 feet apart)	MW-516B to MW-112C (346 feet apart)
Jul-07	1.4	2.3	1.4
Oct-09	1.4	4.3	1.2
Historical Average:	1.4	3.3	1.3
Phase 1	MW-501B to MW-503B (347 feet apart)	MW-513B to MW-508B (366 feet apart)	MW-516B to MW-112C (346 feet apart)
Beginning of Sparging	1.3	2.5	1.9
Winter Rest Period	1.3	3.1	1.6
End of Sparging	1.3	3.9	1.2
Average During Sparging:	1.3	3.1	1.5
Phase 2	MW-501B to MW-503B (347 feet apart)	MW-513B to MW-508B (366 feet apart)	MW-516B to MW-112C (346 feet apart)
Beginning of Sparging	1.5	4.3	1.8
Winter Rest Period	1.4	4.2	1.6
End of Sparging	1.2	4.0	1.3
Average During Sparging:	1.3	4.1	1.6

Notes:

1. All values in units of feet (ft)
2. A positive number indicates the well within the sparging footprint had a higher water level than the well west of the sparging footprint
3. The first well in each pair is the well within the sparging footprint and the second well is located west of the sparging footprint. i.e. MW-501B is within the sparging footprint

As discussed in Section 2.1.5, monitoring wells and piezometers within the sparging footprint were fitted with threaded caps prior to sparging. These threaded caps were extremely effective in containing the rising waters in monitoring wells and piezometers. There were no apparent long term effects of sparging on the piezometric surface in the deep Satilla. The piezometric surface elevation rose and fell during sparge operations but gradually returned to pre-sparge levels during rest periods.

During Phase 1 and 2, water levels in three pairs of monitoring wells were measured with transducers to evaluate change in head differences sparging efforts to assess migration of deep Satilla water outside the sparging footprint. One well within each pair was located within the sparging footprint and one well was located west of the sparging footprint, adjacent to the marsh. The selected well pairs were MW-501B and MW-503B, MW-513B and MW-508B, and MW-516B and MW-112C. Available groundwater levels from July 2007 and October 2009 (provided by EPS Planning Specialists, Inc.) and data from Phase 1 operations were used to calculate the historical averages of pre-sparge head differences in each monitoring well pair, as shown in Table 4-10. Hydrographs of these paired water levels (in ft NAVD 88) are provided in the Phase 2 report (Mutch Associates and Parsons, 2015). A least squares regression, linear trend line

was fit to water levels obtained from monitoring well transducer data and the difference between the trend lines was taken at three points during the sparging period and then averaged. For each monitoring pair, the average head difference during sparging was not significantly different from the historical average as shown in Table 4-10. Therefore, CO₂ sparging had an insignificant impact on deep Satilla groundwater migration as the average westerly hydraulic gradient did not appreciably change during the sparging activities.

5 CONCLUSIONS AND RECOMMENDATIONS

5.1 Conclusions

In summary, for the Phase 3 sparging:

- Nearly all (28 out of 30; 93%) of the deep Satilla monitoring and extraction wells had a pH of less than 10.5. Most of these monitoring points had pH less than 7.5 (23 out of 30; 77%). In the southern area, the majority of post-Phase 3 discrete groundwater samples collected by Geoprobe from the base of the Satilla aquifer were less than 10.5; and
- The majority (23 out of 30; 77%) of the deep Satilla monitoring and extraction wells had total Hg concentrations less than 20 µg/L. About one-third of these monitoring points (11 out of 30; 37%) had total Hg concentrations less than 2.0 µg/L.

A summary of the overall effect of Phase 1 - 3 sparging on the CBP is presented below:

- CO₂ sparging has been extremely effective at lowering the pH in the deep Satilla aquifer. The mean pH in the deep Satilla monitoring points has decreased from 11.32 (2011-2012) to 7.11 as a result of CO₂ sparging (Table 4-1). The median pH decreased from 11.49 to 6.57 (Table 4-1).
- The SG (and therefore the density) of groundwater within the deep Satilla has decreased as a result of CO₂ sparging. Computed SG decreased in 20 out of 30 deep Satilla monitoring locations. The median computed SG decrease from 1.009 to 1.007 from pre-Phase 1 to post-Phase 3 was statistically significant at the 95% confidence level.
- CO₂ sparging has also been extremely effective at lowering concentrations of Hg in the deep Satilla. Almost every deep Satilla monitoring point (28 out of 30) has lower total Hg when compared to 2011-2012 levels as a result of CO₂ sparging. The mean Hg concentration in all monitoring points was lowered from 270 to 36 µg/L, a percent decrease of 87%. The median Hg concentration in all monitoring points was lowered from 128 to 4 µg/L, a percent decrease of 97%.

5.2 Recommendations

The AOC for the caustic brine plume requires that the pH be reduced to 10 to 10.5 and that density be reduced. The three Phase CO₂ sparging effort has clearly met both of these RAOs. To date, rebound of pH to values greater than 10.5 has been minimal during the rest period in-between phases. Therefore, extensive rebound is not expected within the treated area, with the exception of the eastern edge of the northern area, which will be addressed as part of a separate regulatory process for the soils beneath the

former cell building. No additional sparging at the Site is recommended as the CO₂ treatment has achieved the RAOs.

6 REFERENCES

- Columbia Analytical Services, 2012. Laboratory Results for LCP Chemical, dated June 4, 2012.
- GeoSyntec Consultants, 1997. Remedial Investigation Report Ground Water Operable Unit Volume I LCP Chemicals Brunswick, Georgia.HWEL.018.
- Jay, J.A., Morel, F.M.M., Hemond, H.F., 2000. Mercury speciation in the presence of polysulfides. *Environ. Sci. Technol.* 34, 2196-2200.
- Kohfahl, C., Post, V.E.A., Hamann, E., Prommer, H., Simmons, C.T., 2015. Validity and slopes of the linear equation of state for natural brines in salt lake systems. *Journal of Hydrology* 523, 190-195.
- Mutch Associates, 2012. Final Work Plan for CO₂ Sparging Proof of Concept Test.
- Mutch Associates, 2014. Technical Approach for Phase 2 CO₂ Sparging, LCP Chemicals Site, Brunswick GA.
- Mutch Associates, 2015a. Supplemental Geoprobe Investigation, LCP Chemicals Site, Brunswick GA
- Mutch Associates, 2015b. Technical Approach for Phase 3 CO₂ Sparging, LCP Chemicals Site, Brunswick GA (Revision 1)
- Mutch Associates, Parsons, 2013a. CO₂ Sparging Work Plan, LCP Chemicals Site, Brunswick, GA.
- Mutch Associates, Parsons, 2013b. CO₂ Sparging Proof of Concept Test Report.
- Mutch Associates, Parsons, 2013c. CO₂ Sparging Proof of Concept: 6 month post-sparge monitoring results.
- Mutch Associates, Parsons, 2014. CO₂ Sparging Phase 1 Full-Scale Implementation And Monitoring Report.
- Mutch Associates, Parsons, 2015. CO₂ Sparging Phase 2 Full-Scale Implementation And Monitoring Report. Revision 2
- Pettine, M., Barra, I., Campanella, L., Millero, F.J., 1998. Effect of Metals on the Reduction of Chromium(VI) with Hydrogen Sulfide. *Water Res.* 32, 2807-2813.
- Pettine, M., Millero, F.J., Passino, R., 1994. Reduction of chromium(VI) with hydrogen-sulfide in NaCl media. *Marine Chem.* 46, 335-344.
- Skyllberg, U., 2008. Competition among thiols and inorganic sulfides and polysulfides for Hg and MeHg in wetland soils and sediments under suboxic conditions: Illumination of controversies and implications for MeHg net production. *J. Geophys. Res.* 113, G00C03.
- Suthersan, S.S., 1997. *Remediation Engineering: Design Concepts*. CRC Press.
- USEPA Region 4 Science and Ecosystem Support Division, 2013. *Field Branches Quality System and Technical Procedures*.

Yeskis, D., Zavala, B., 2002. Ground-Water Sampling Guidelines for Superfund and RCRA Project Managers.

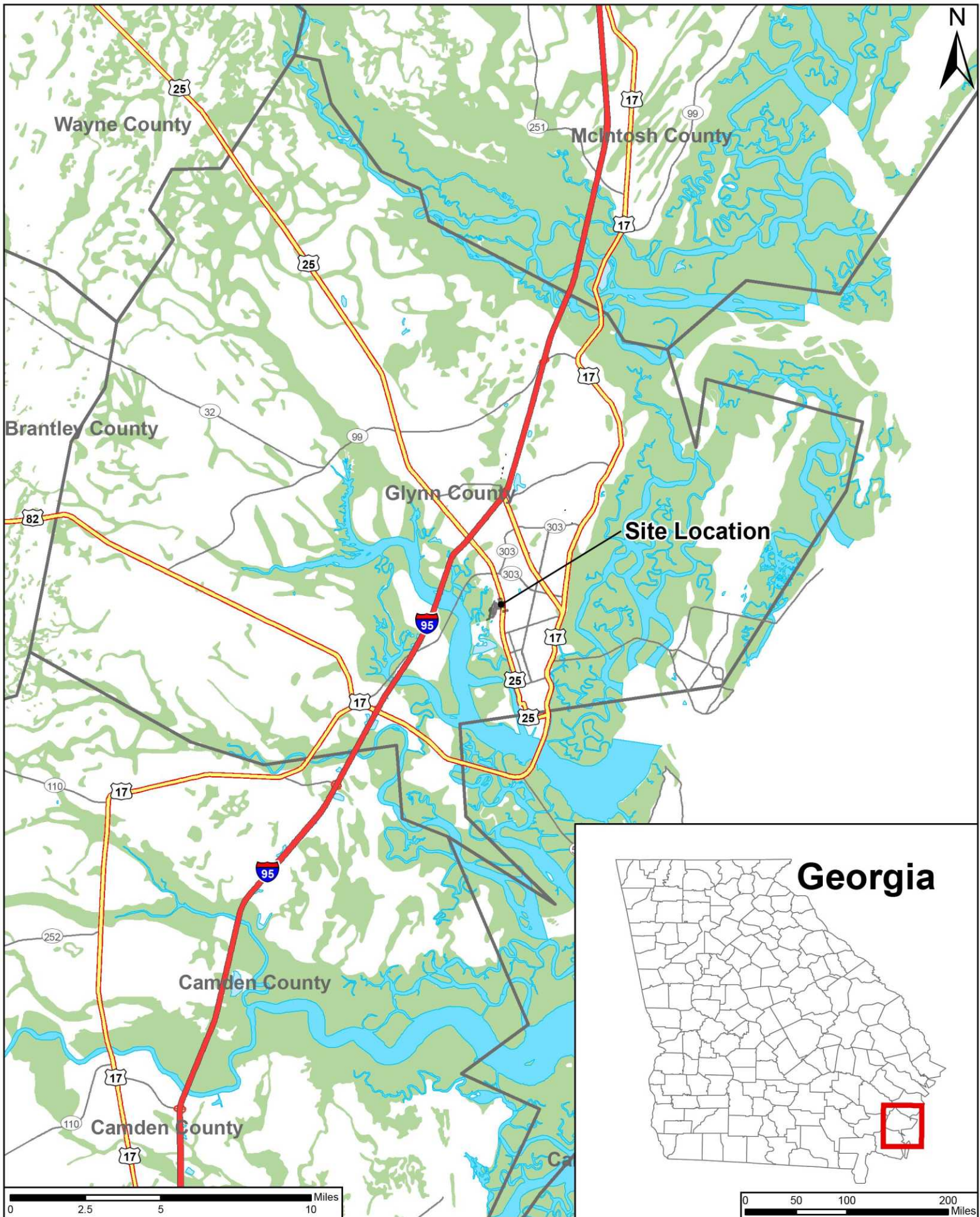

Figure 1-1: Site location map
 LCP Chemicals Site, Brunswick, GA

Legend

- Deep Satilla Monitoring Point
- CBP, pH>10.5



Figure 1-2: Map showing location of CBP footprint
LCP Chemicals Site, Brunswick, GA

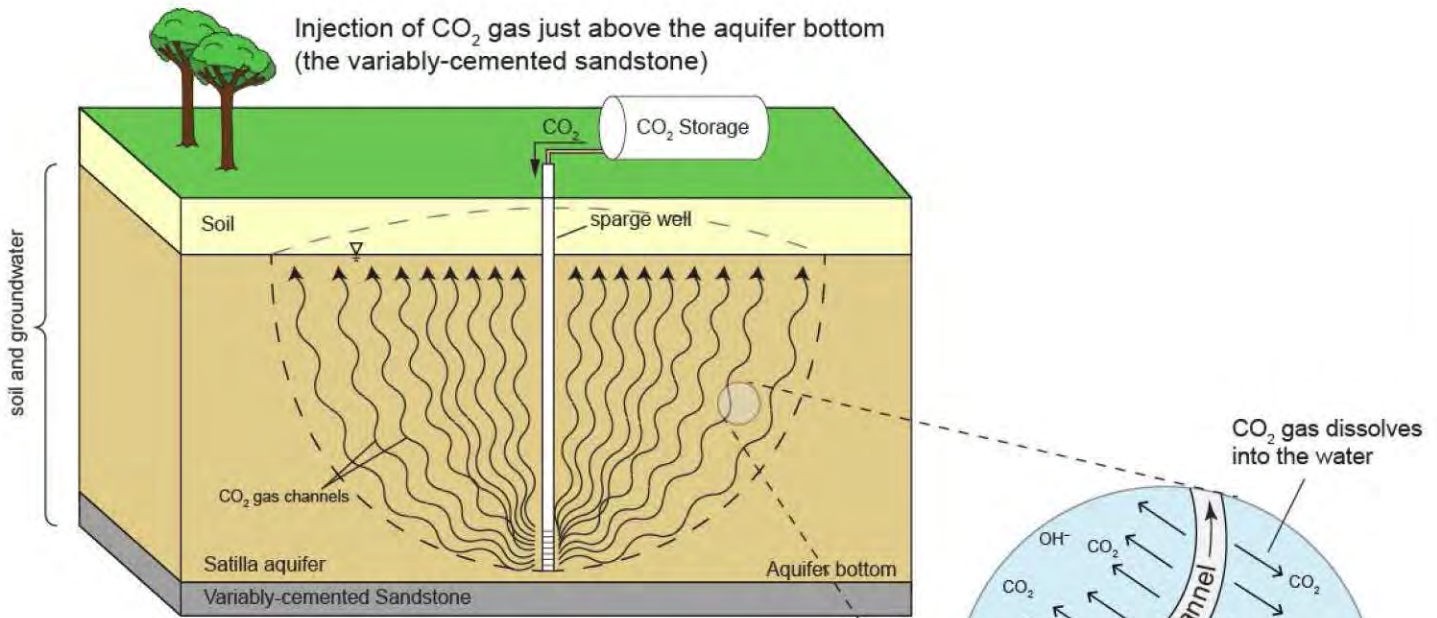

CO₂ reacts with alkali (OH⁻); pH is neutralized & a pH buffer (HCO₃⁻) is produced which prevents excessive pH decline

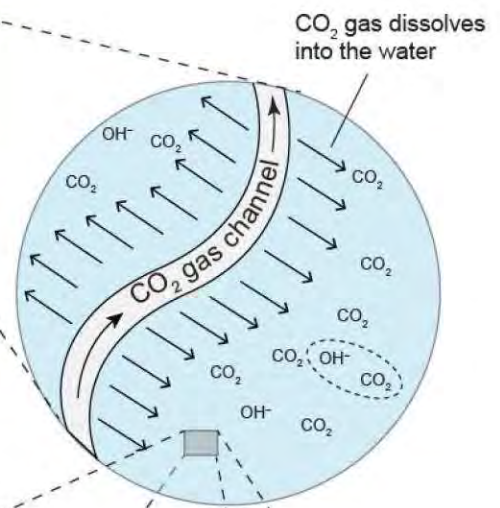
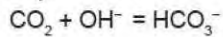

When the pH is lowered, mercury is immobilized as mercury sulfide, HgS(s).

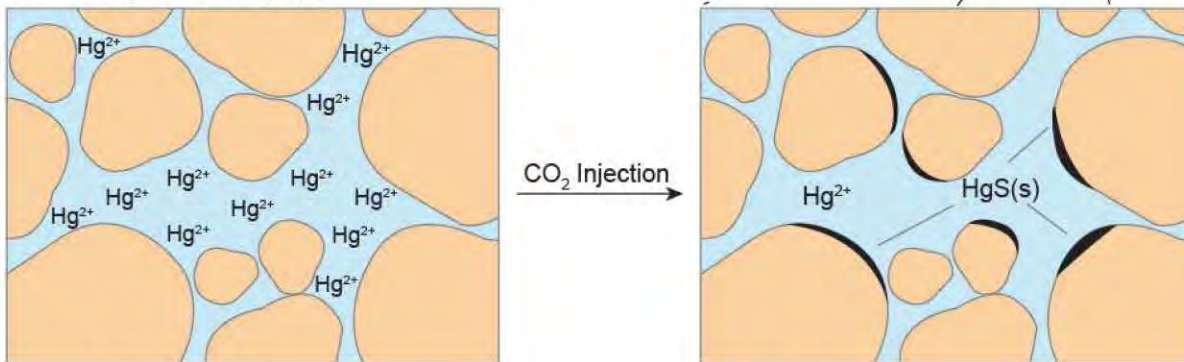

Before

After

Figure 1-3: Conceptual model of CO₂ sparging

LCP Chemicals Site, Brunswick, GA

Legend

Sparse Wells

- Proof of Concept
- Phase 1
- Phase 2
- Phase 3
- Phase 1 Footprint
- Phase 2 Footprint
- Historical Structures
- Marsh Boundary
- Infiltration Gallery
- Elevated Pad

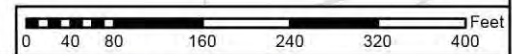
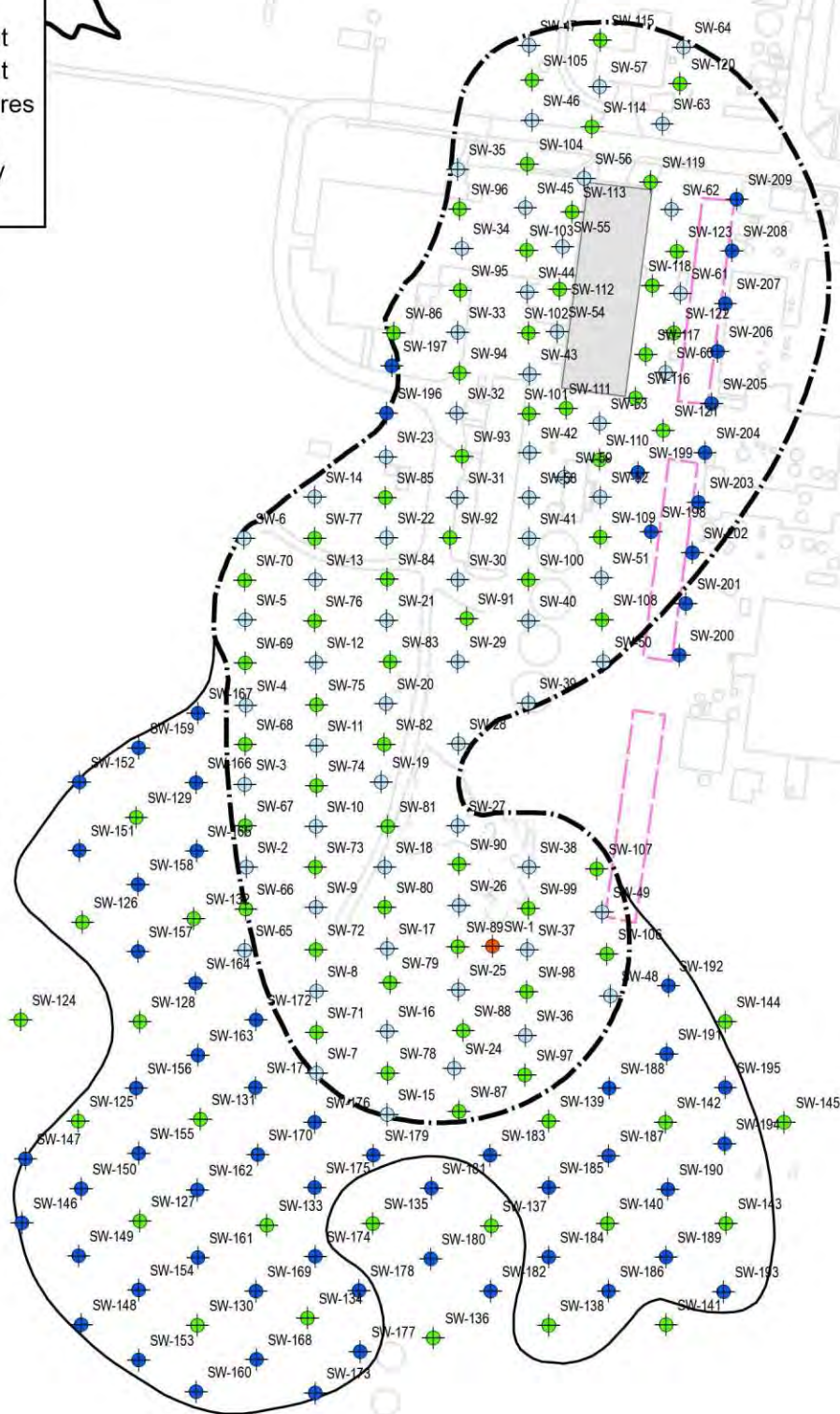

Figure 2-1: Locations of Phase 3 sparse wells
LCP Chemicals Site, Brunswick, GA

Legend

Sparge Wells

- Proof of Concept
- ⊕ Phase 1
- ⊕ Phase 2
- ⊕ Phase 3

--- Phase 1 Footprint

— Phase 2 Footprint

— Historical Structures

— Marsh Boundary

▭ Infiltration Gallery

▭ Elevated Pad

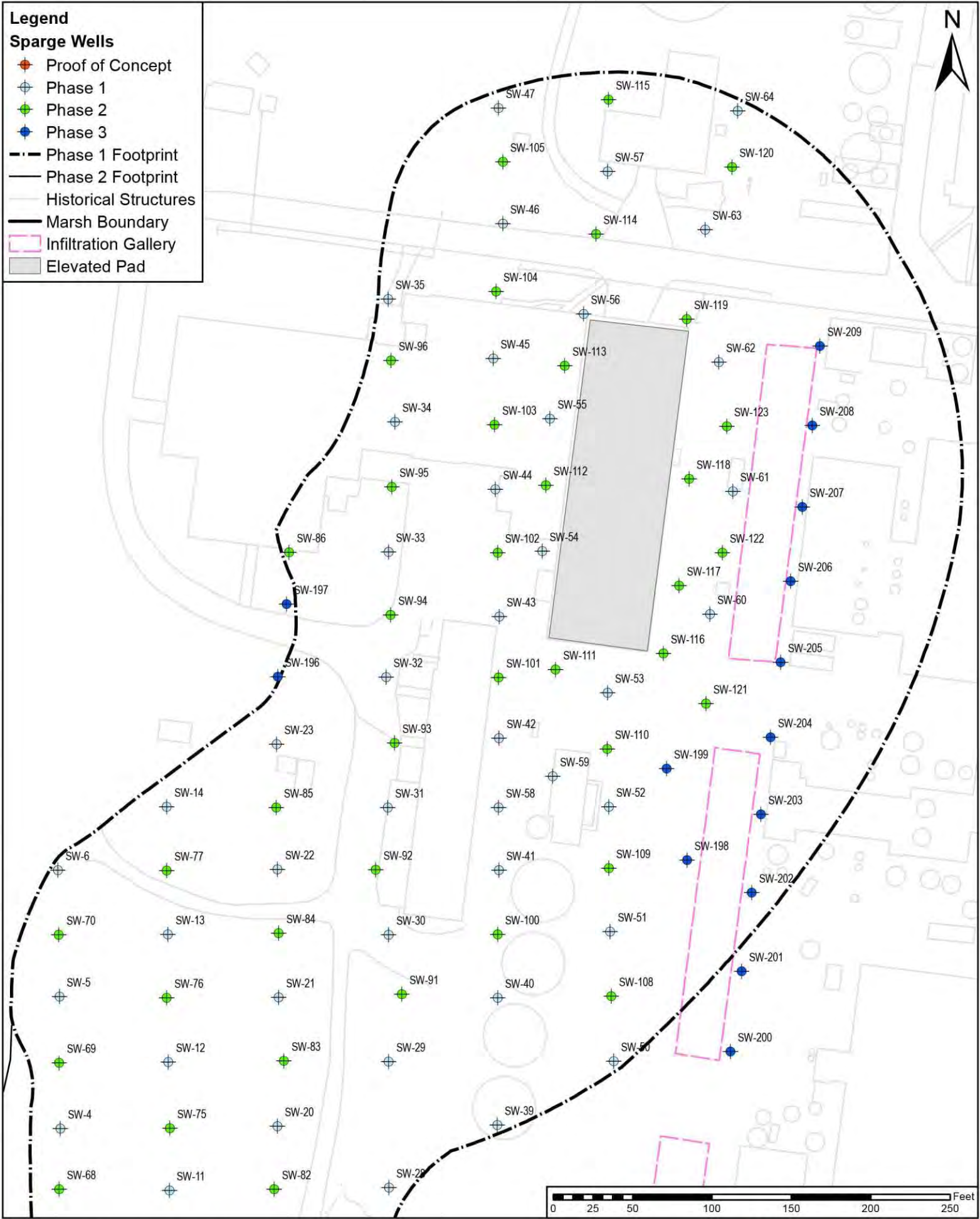

Figure 2-2: Locations of Northern Phase 3 sparge wells
LCP Chemicals Site, Brunswick, GA

Legend

Sparge Wells

- Proof of Concept
- ⊕ Phase 1
- ⊕ Phase 2
- Phase 3

--- Phase 1 Footprint

— Phase 2 Footprint

— Historical Structures

— Marsh Boundary

▭ Infiltration Gallery

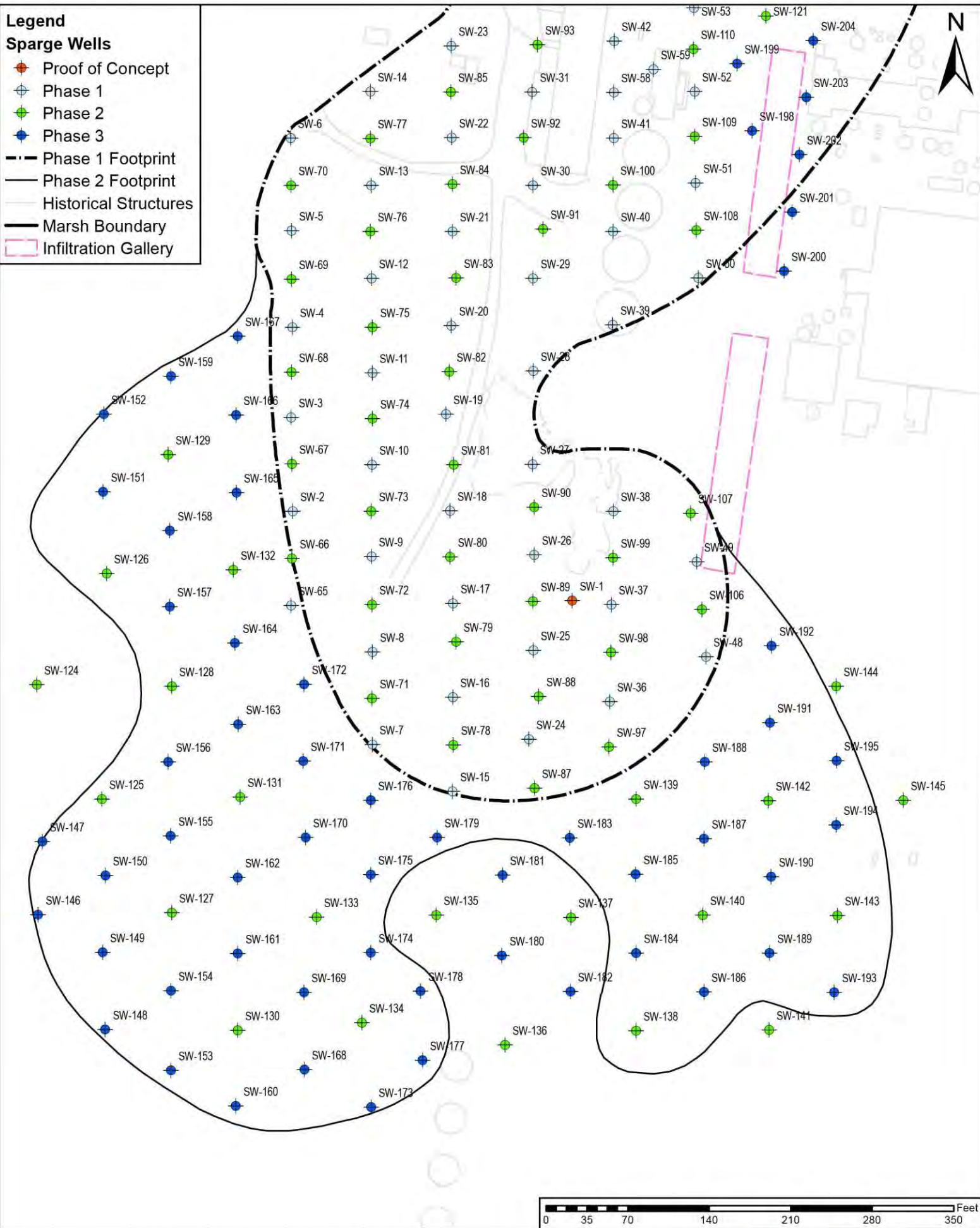

Figure 2-3: Locations of Southern Phase 3 sparge wells
LCP Chemicals Site, Brunswick, GA

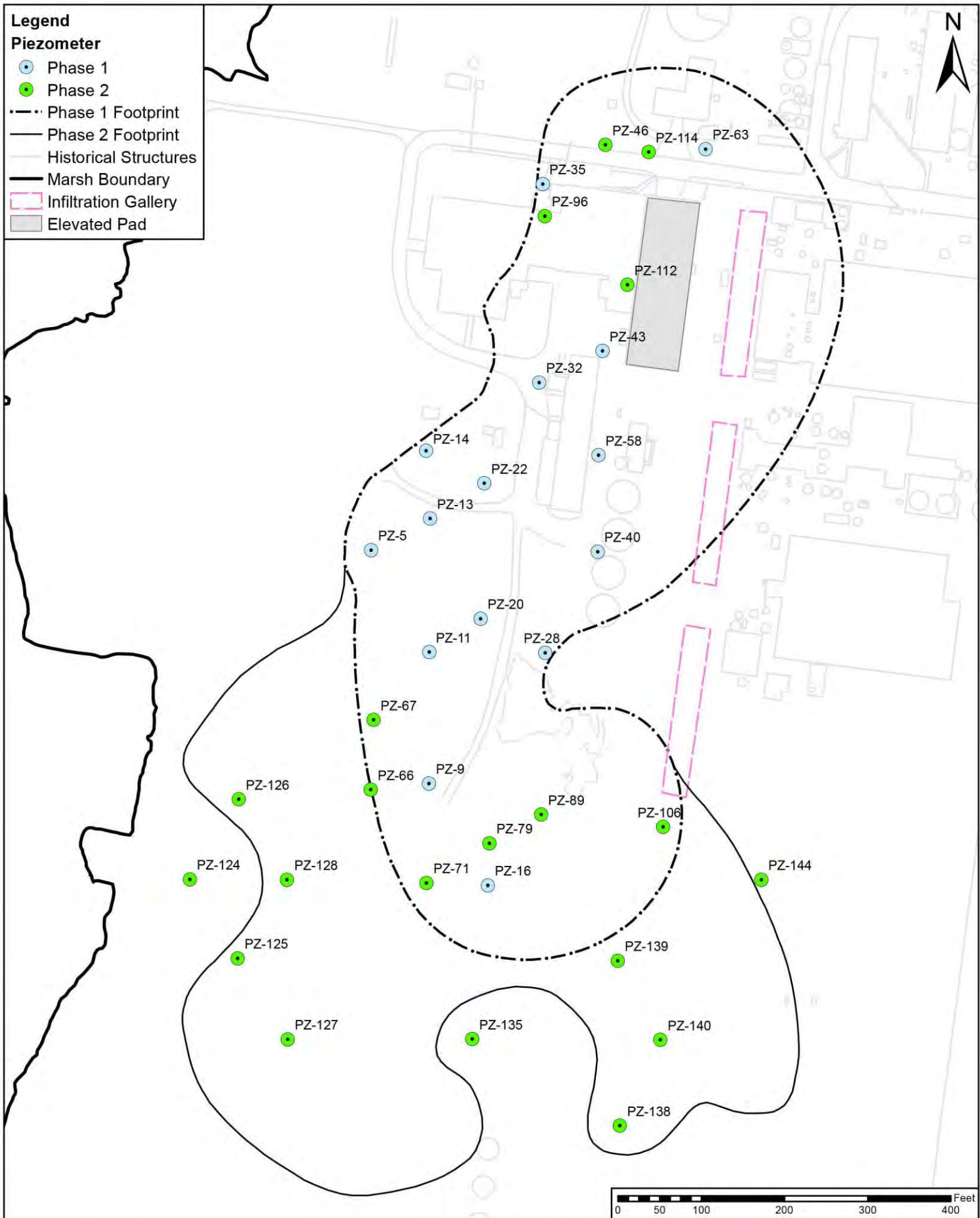

Figure 2-4: Location of piezometers utilized in monitoring Phase 3 CO₂ sparging
LCP Chemicals Site, Brunswick, GA

Legend

- Phase 1 Footprint
- Phase 2 Footprint
- Historical Structures
- Marsh Boundary
- Infiltration Gallery
- Elevated Pad
- Extraction well (EW) in treatment area
- Monitoring well (MW) in treatment area
- MW outside treatment area
- MW not monitored during Phase 3
- EW not monitored during Phase 3
- ◆ Sparge Wells

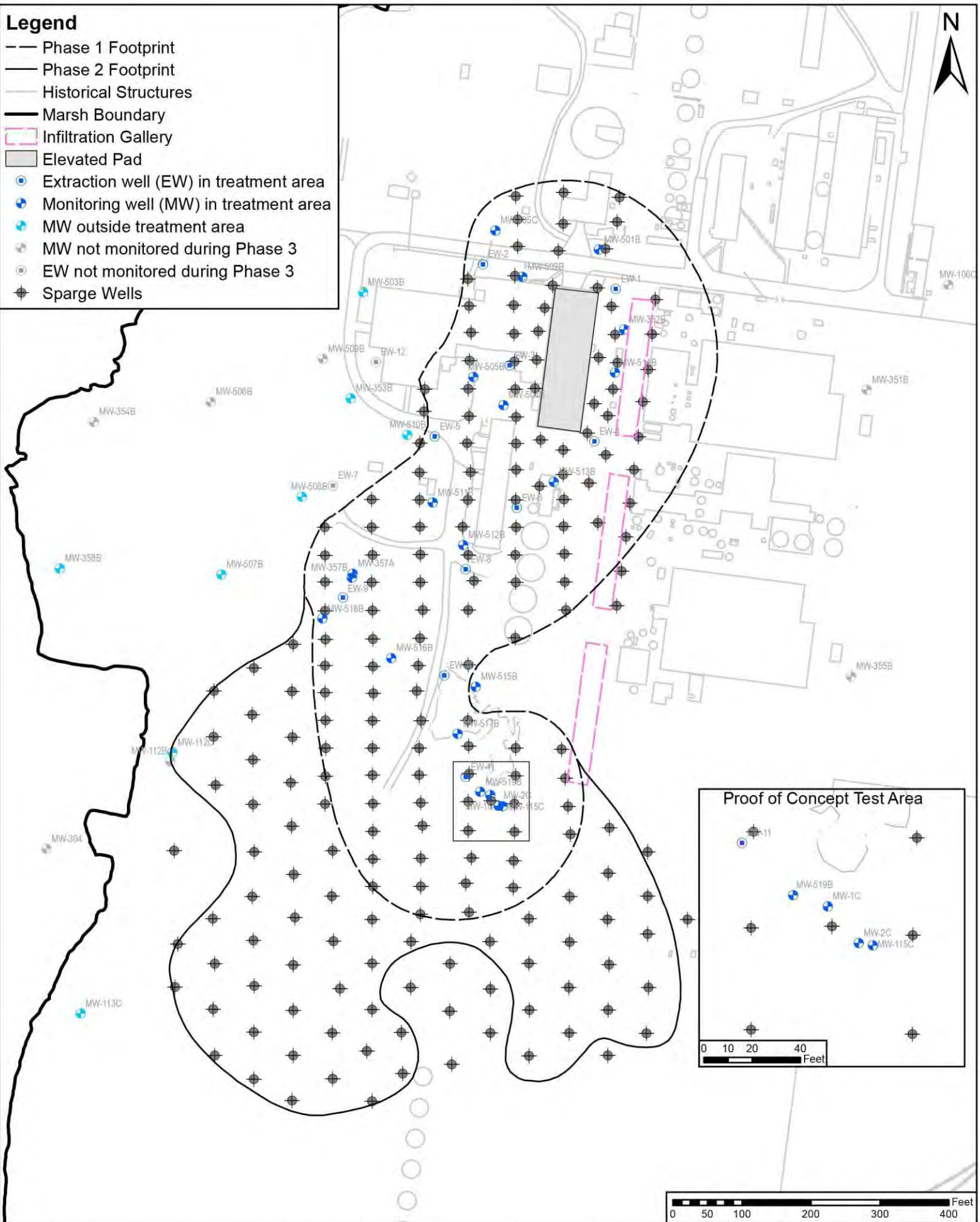

Figure 2-5: Monitoring well network used to evaluate Phase 3 CO₂ sparging
LCP Chemicals Site, Brunswick, GA

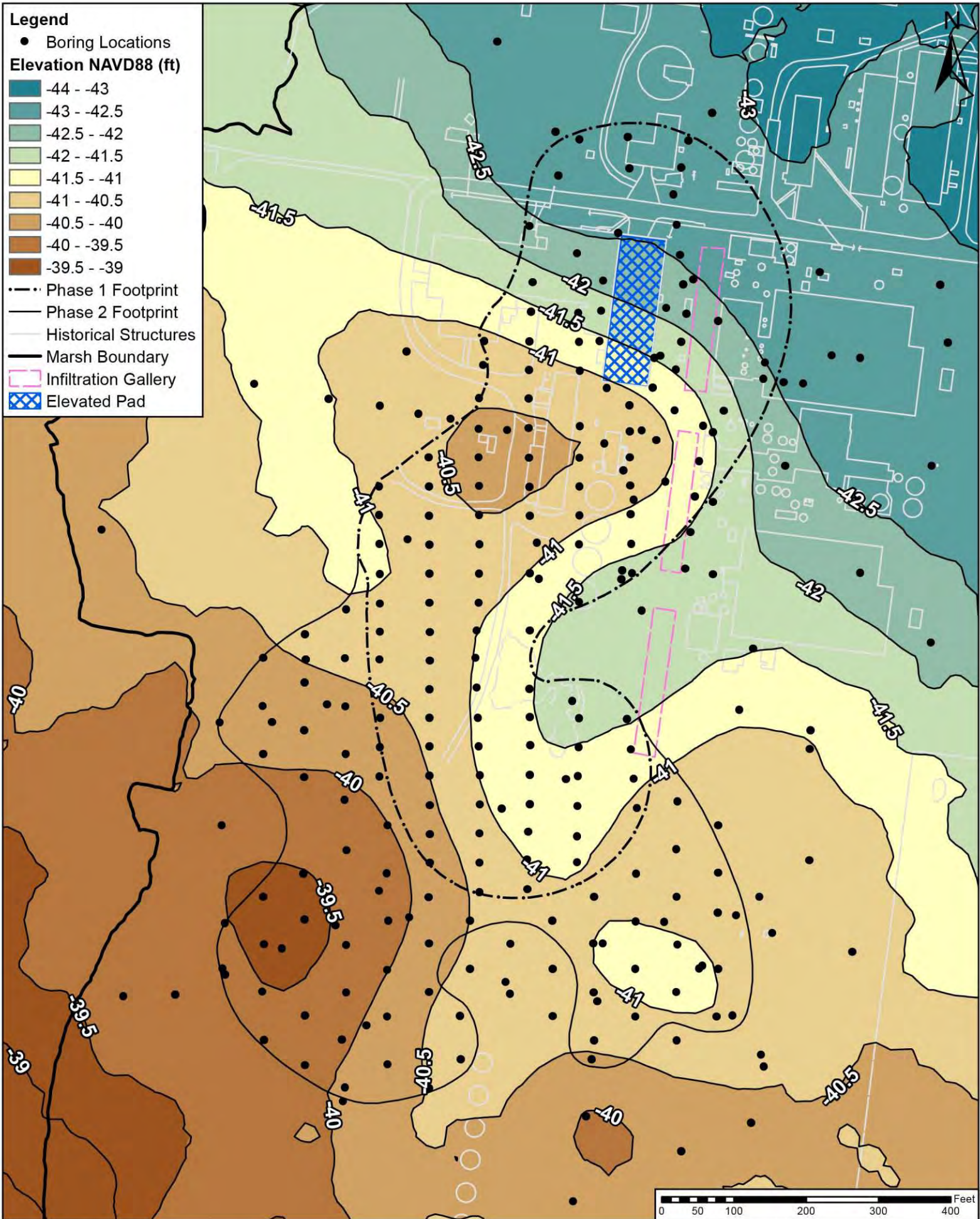

Figure 2-6: Structural contours of the top of the variably-cemented sandstone
LCP Chemicals Site, Brunswick, GA

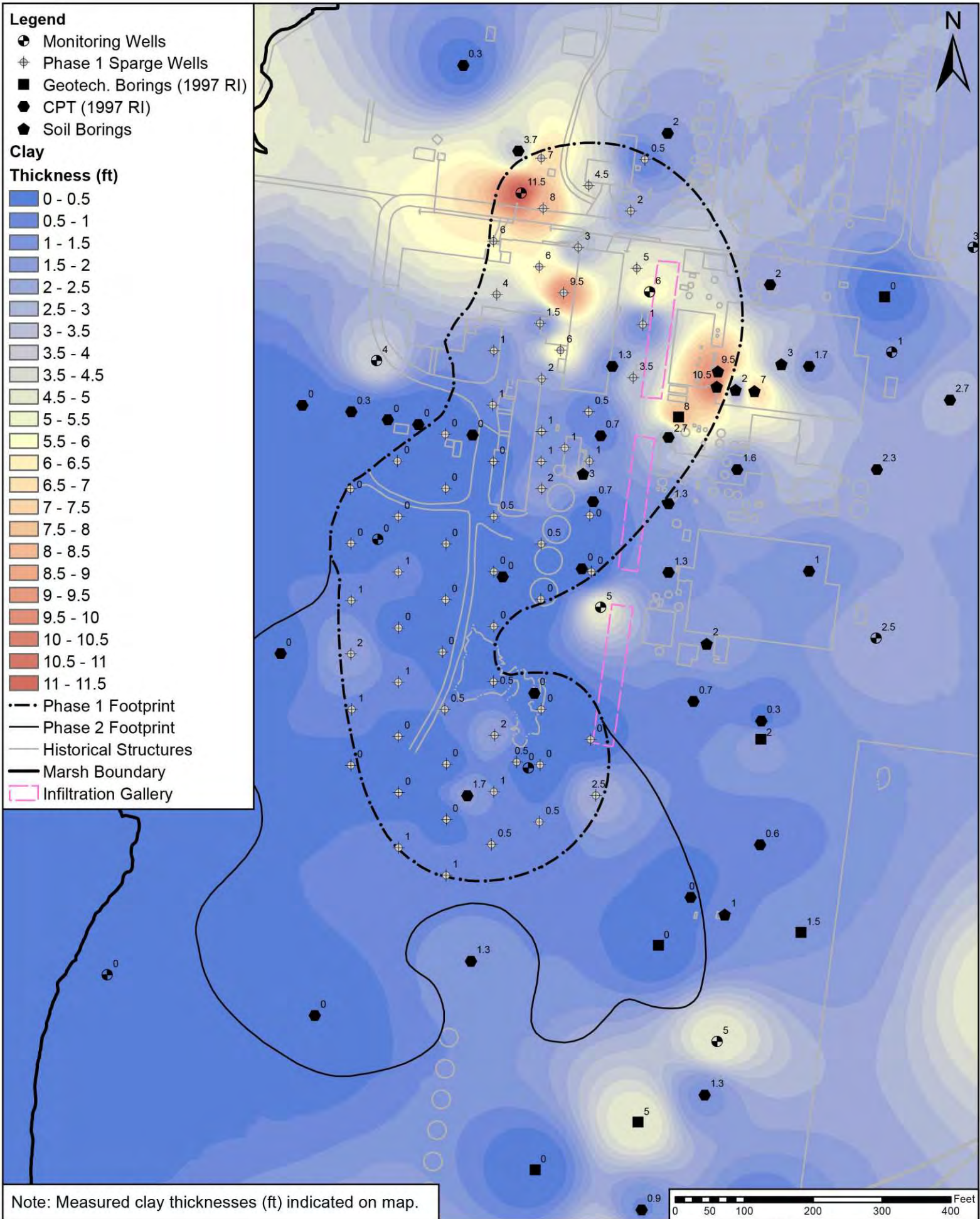
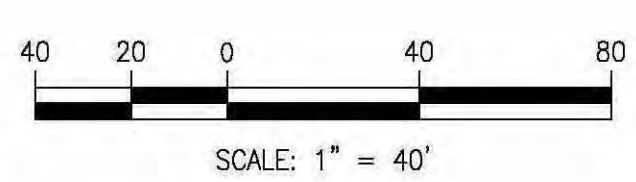
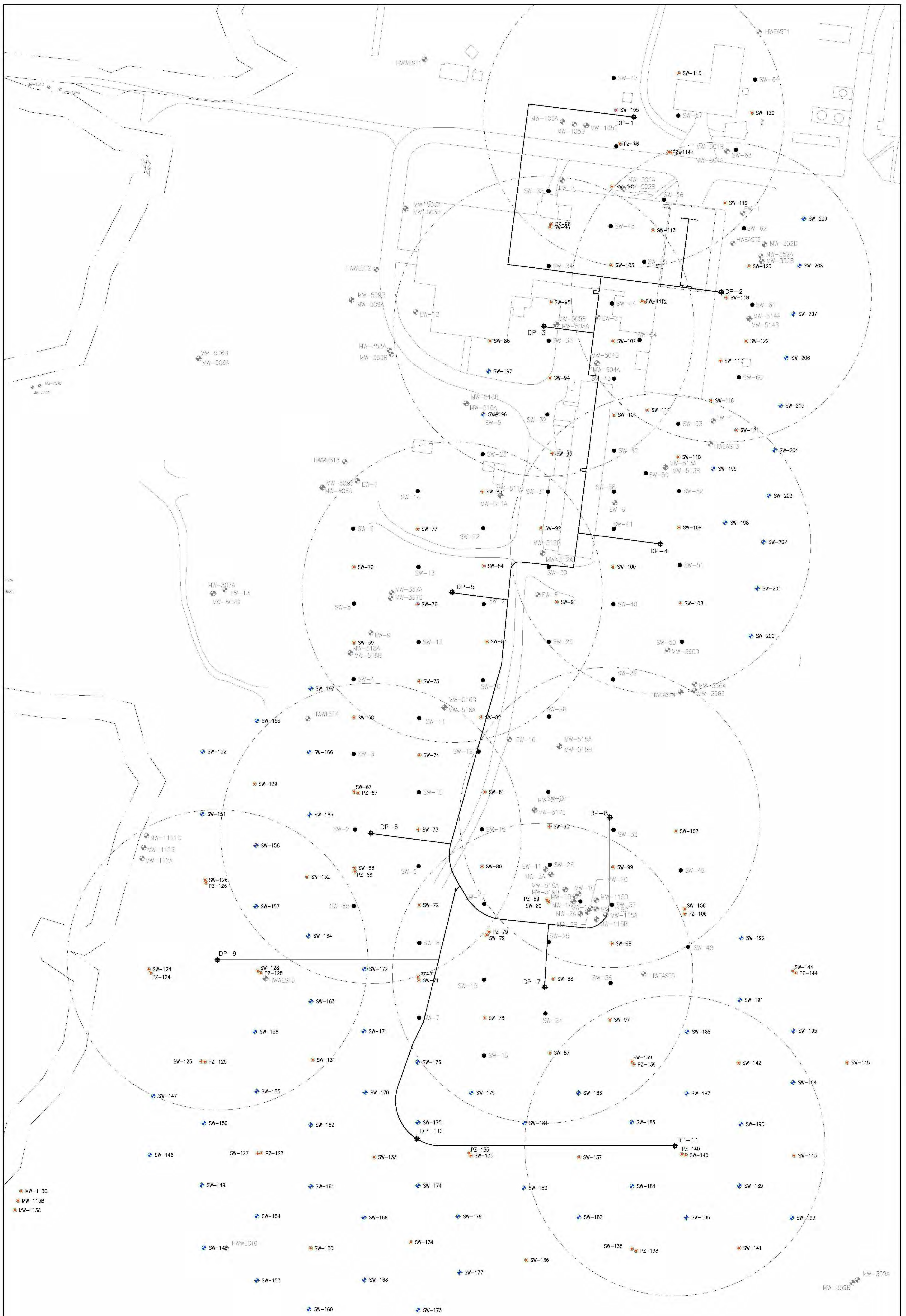

Figure 2-7: Clay isopach map
LCP Chemicals Site, Brunswick, GA



NO.	DESCRIPTION	DATE	DRAWN	CHK'D	APP'D
C	FOR INFORMATION ONLY	6/27/16	RRR		
B	FOR INFORMATION ONLY	4/15/14	JTS		
A	FOR INFORMATION ONLY	10/23/13	JTS		

PROJECT TITLE
Honeywell
 LCP CHEMICALS SITE
 CARBON DIOXIDE SPARGING SYSTEM
 BRUNSWICK, GEORGIA

PARSONS
 ENVIRONMENT AND INFRASTRUCTURE
 OFFICE: 301 PLAINFIELD ROAD
 SYRACUSE, NY 13212
 (315) 451-9560

DRAWING TITLE: **FIGURE 2-8**
 SITE OPERATIONS PLAN
 SCALE: 1"=40'-0"
 DRAWING NO.: **FIGURE 2-8**
 JOB: 4484.34
 WBS:
 REV: **C**

NOTICE: THIS DRAWING IS THE PROPERTY OF HONEYWELL. IT IS FURNISHED SUBJECT TO RETURN ON DEMAND AND THE CONDITION THAT THE INFORMATION AND TECHNOLOGY EMBODIED HEREIN SHALL NOT BE DISCLOSED OR USED AND THE DRAWING SHALL NOT BE REPRODUCED OR COPIED IN WHOLE OR IN PART EXCEPT AS PREVIOUSLY AUTHORIZED IN WRITING. ANY PERSON WHO MAY RECEIVE OR OBSERVE THIS DESIGN WILL BE HELD STRICTLY LIABLE FOR ANY VIOLATION WHETHER WILLFUL OR NEGLIGENT.

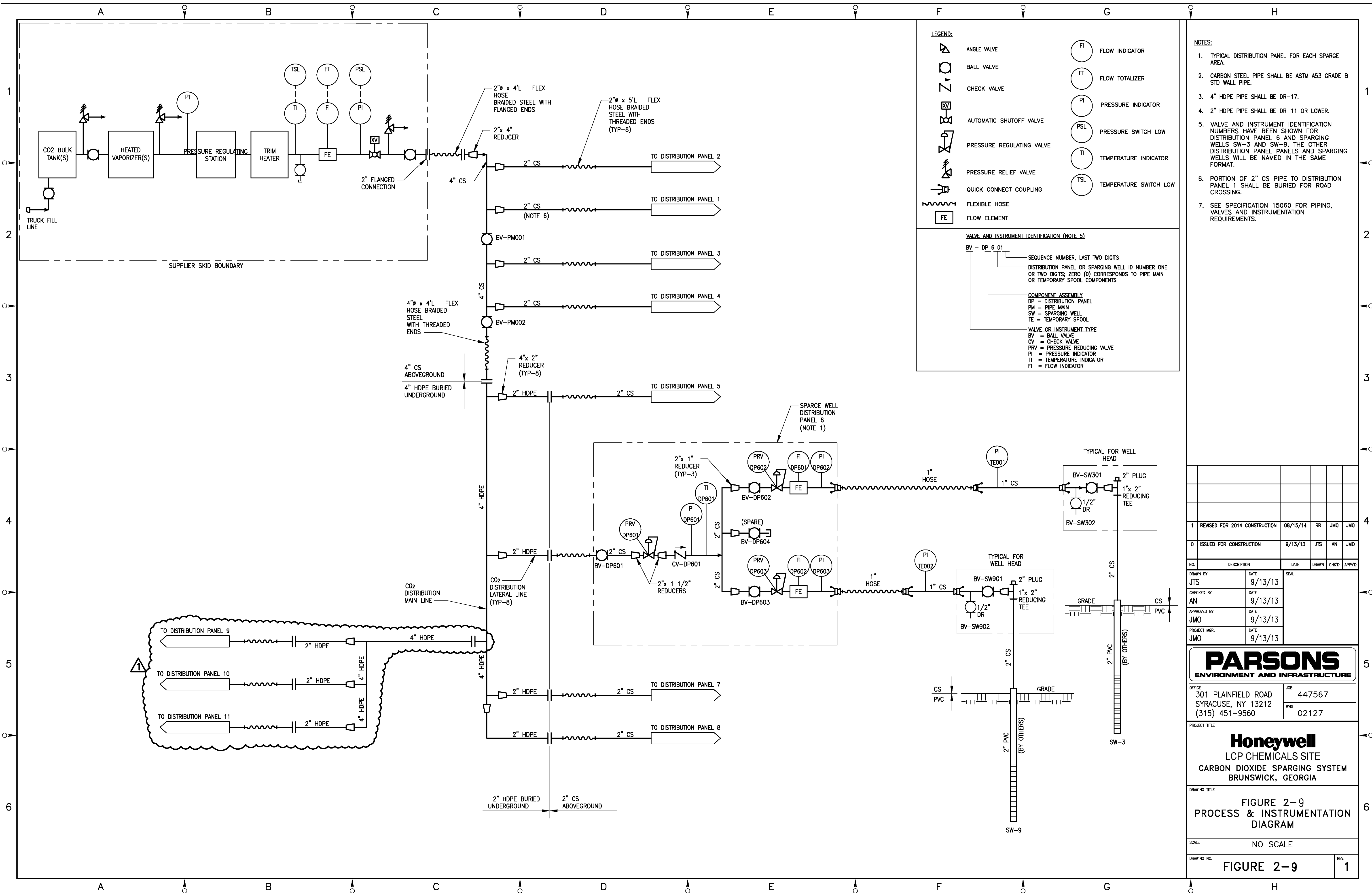

LEGEND:

	ANGLE VALVE		FLOW INDICATOR
	BALL VALVE		FLOW TOTALIZER
	CHECK VALVE		PRESSURE INDICATOR
	AUTOMATIC SHUTOFF VALVE		PRESSURE SWITCH LOW
	PRESSURE REGULATING VALVE		TEMPERATURE INDICATOR
	PRESSURE RELIEF VALVE		TEMPERATURE SWITCH LOW
	QUICK CONNECT COUPLING		
	FLEXIBLE HOSE		
	FLOW ELEMENT		

VALVE AND INSTRUMENT IDENTIFICATION (NOTE 5)

BY - DP 6 01

- SEQUENCE NUMBER, LAST TWO DIGITS
- DISTRIBUTION PANEL OR SPARGING WELL ID NUMBER ONE OR TWO DIGITS; ZERO (0) CORRESPONDS TO PIPE MAIN OR TEMPORARY SPOOL COMPONENTS

COMPONENT ASSEMBLY

- DP = DISTRIBUTION PANEL
- PM = PIPE MAIN
- SW = SPARGING WELL
- TE = TEMPORARY SPOOL

VALVE OR INSTRUMENT TYPE

- BV = BALL VALVE
- CV = CHECK VALVE
- PRV = PRESSURE REDUCING VALVE
- PI = PRESSURE INDICATOR
- TI = TEMPERATURE INDICATOR
- FI = FLOW INDICATOR

- NOTES:**
- TYPICAL DISTRIBUTION PANEL FOR EACH SPARGE AREA.
 - CARBON STEEL PIPE SHALL BE ASTM A53 GRADE B STD WALL PIPE.
 - 4" HDPE PIPE SHALL BE DR-17.
 - 2" HDPE PIPE SHALL BE DR-11 OR LOWER.
 - VALVE AND INSTRUMENT IDENTIFICATION NUMBERS HAVE BEEN SHOWN FOR DISTRIBUTION PANEL 6 AND SPARGING WELLS SW-3 AND SW-9. THE OTHER DISTRIBUTION PANEL PANELS AND SPARGING WELLS WILL BE NAMED IN THE SAME FORMAT.
 - PORTION OF 2" CS PIPE TO DISTRIBUTION PANEL 1 SHALL BE BURIED FOR ROAD CROSSING.
 - SEE SPECIFICATION 15060 FOR PIPING, VALVES AND INSTRUMENTATION REQUIREMENTS.

NO.	DESCRIPTION	DATE	DRAWN	CHK'D	APP'VD
1	REVISED FOR 2014 CONSTRUCTION	08/15/14	RR	JMO	JMO
0	ISSUED FOR CONSTRUCTION	9/13/13	JTS	AN	JMO

PARSONS
ENVIRONMENT AND INFRASTRUCTURE

OFFICE: 301 PLAINFIELD ROAD SYRACUSE, NY 13212 (315) 451-9560

JOB: 447567

WBS: 02127

Honeywell
LCP CHEMICALS SITE
CARBON DIOXIDE SPARGING SYSTEM
BRUNSWICK, GEORGIA

DRAWING TITLE: **FIGURE 2-9
PROCESS & INSTRUMENTATION
DIAGRAM**

SCALE: NO SCALE

DRAWING NO. **FIGURE 2-9** REV. **1**

- Legend**
- Phase 1 Footprint
 - Phase 2 Footprint
 - Historical Structures
 - Marsh Boundary
 - ▭ Infiltration Gallery
 - ▭ Elevated Pad
 - ⊕ Extraction Well
 - ⊕ Deep Satilla Monitoring Well

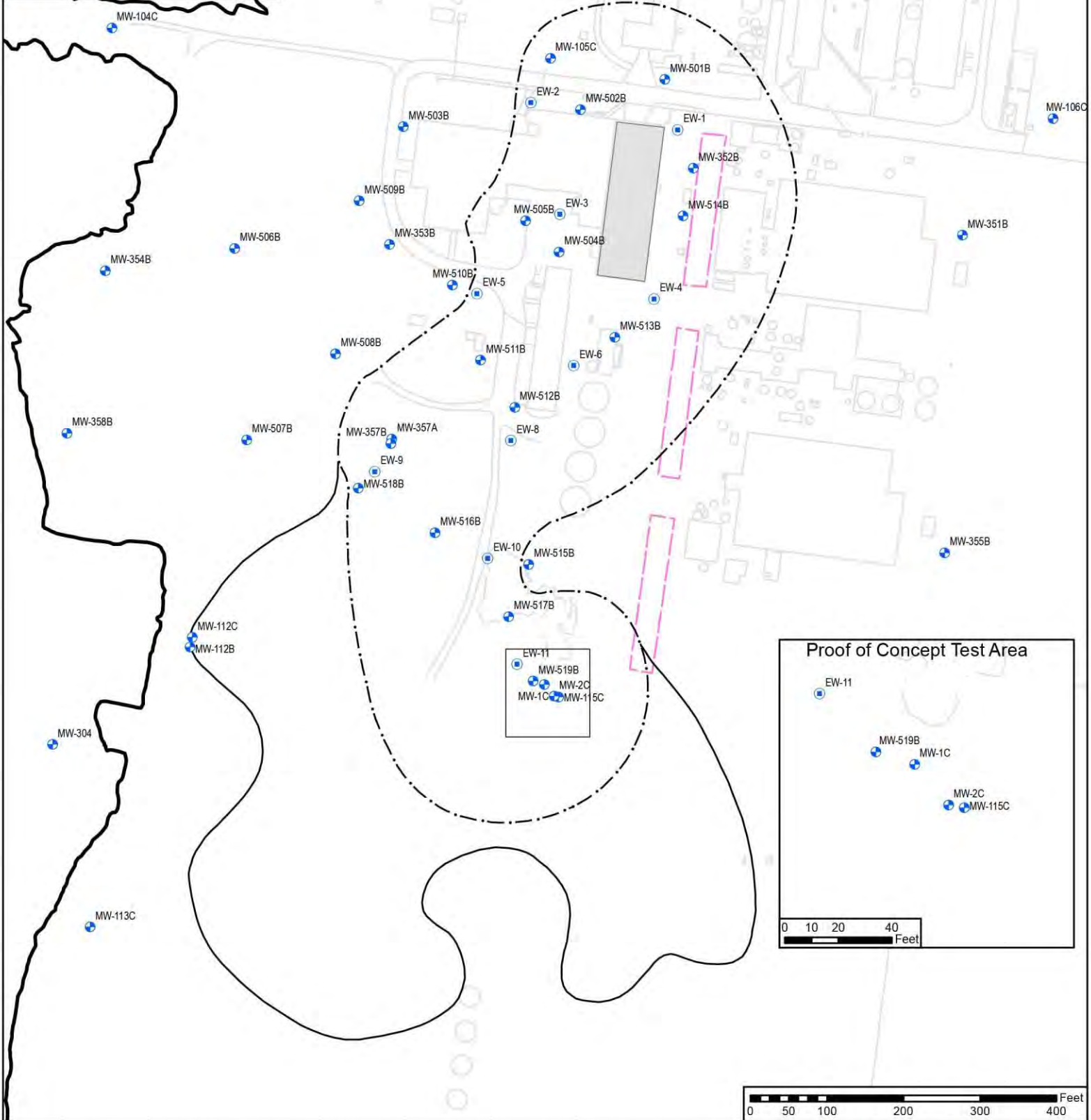

Figure 3-1: Locations of deep Satilla monitoring and extraction wells
LCP Chemicals Site, Brunswick, GA

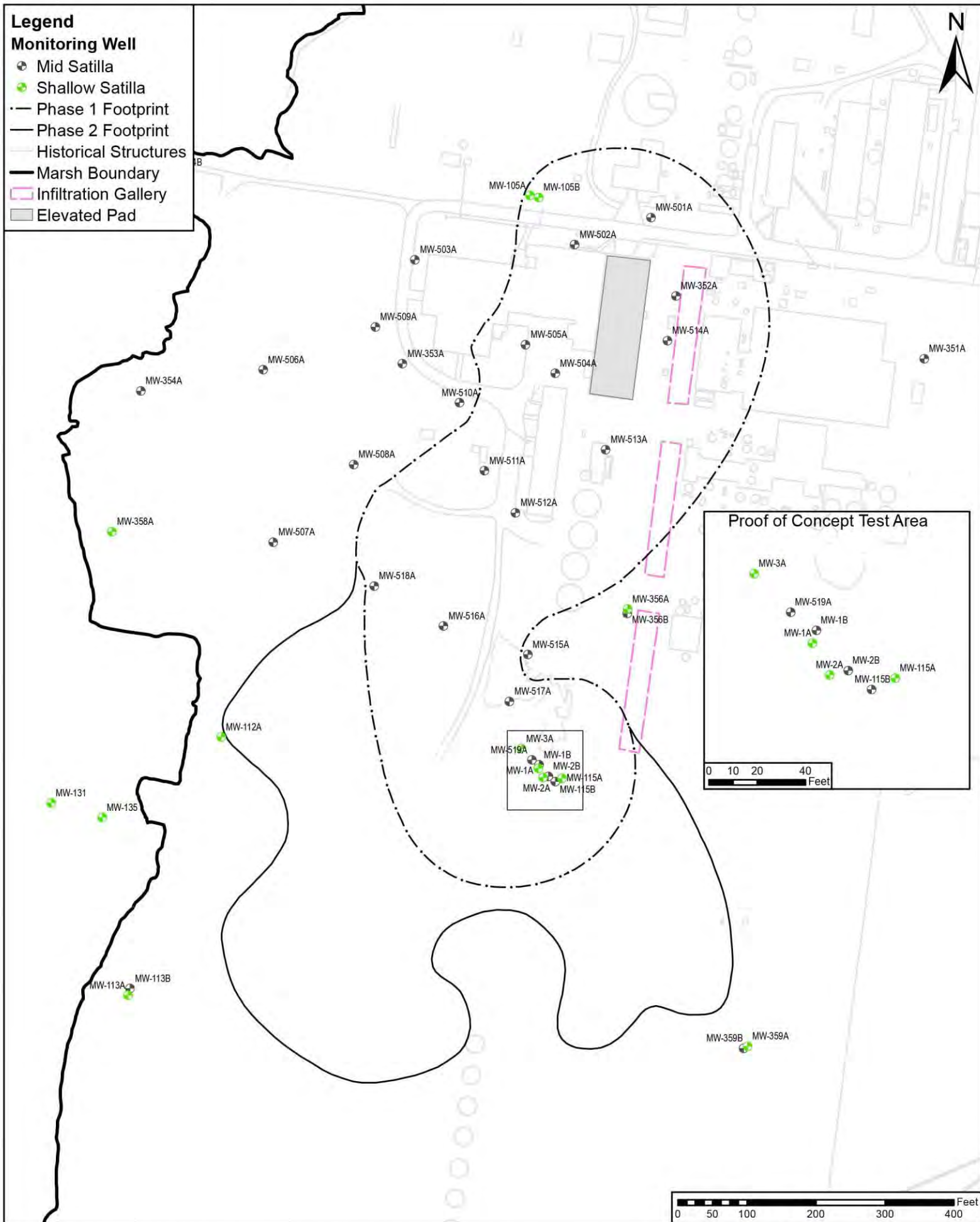

Figure 3-2: Locations of mid and shallow Satilla monitoring wells
 LCP Chemicals Site, Brunswick, GA

Legend

- Coosawhatchie Monitoring Well
- - - Phase 1 Footprint
- Phase 2 Footprint
- Historical Structures
- Marsh Boundary
- ▭ Infiltration Gallery
- ▭ Elevated Pad

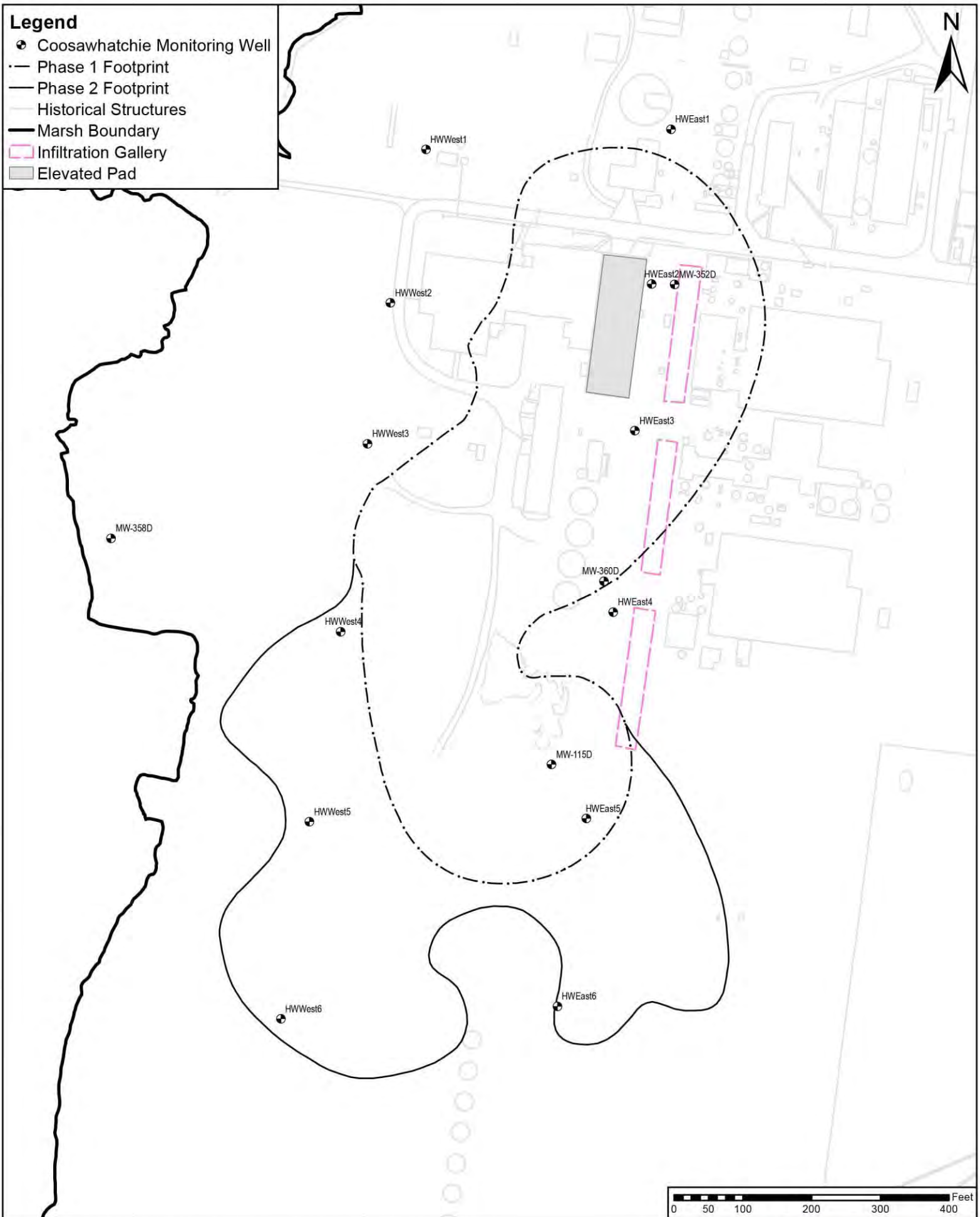

Figure 3-3: Locations of Coosawhatchie A/B monitoring wells
LCP Chemicals Site, Brunswick, GA

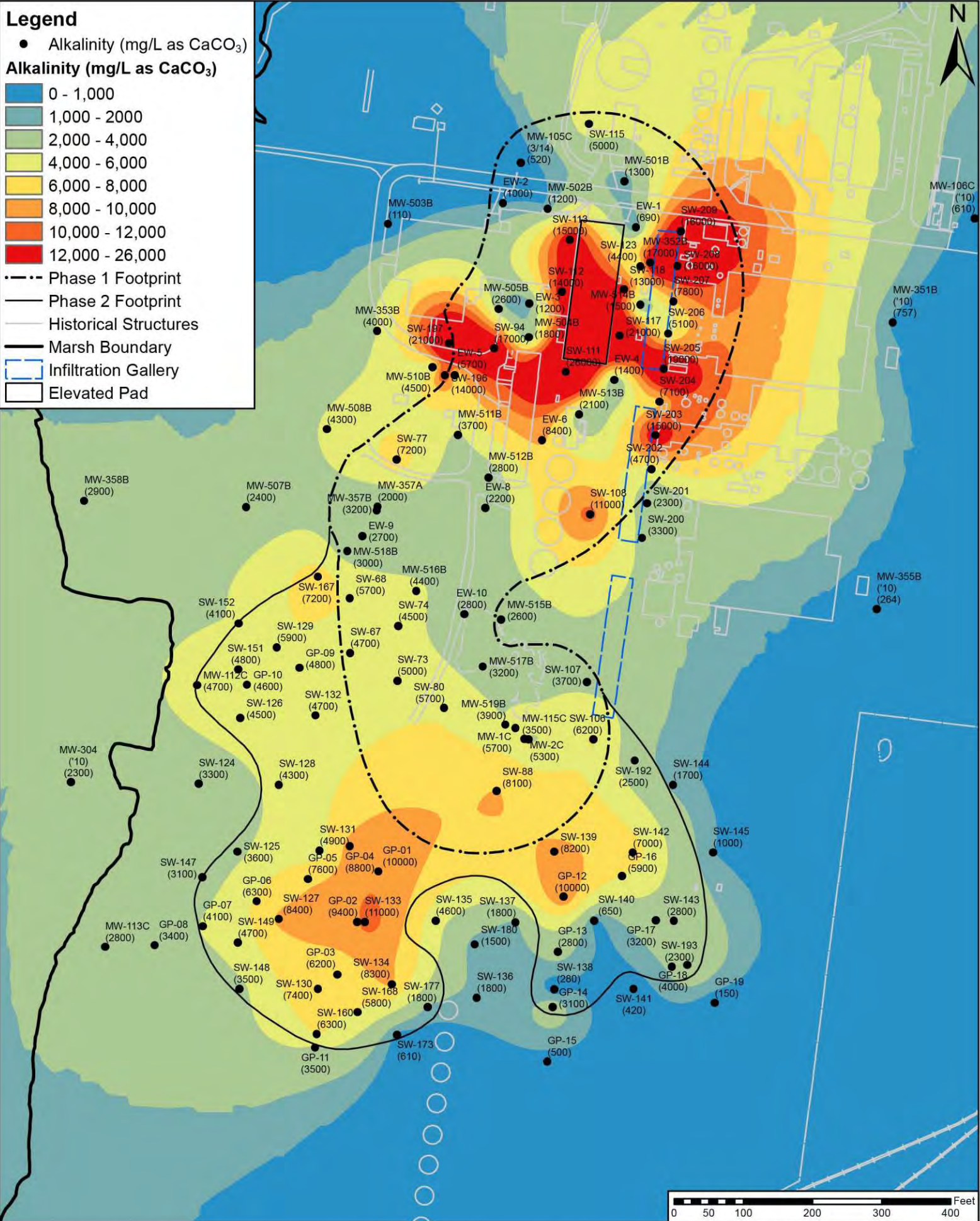

Figure 3-4: Interpolated alkalinity in the Satilla using data from deep monitoring locations LCP Chemicals Site, Brunswick, GA

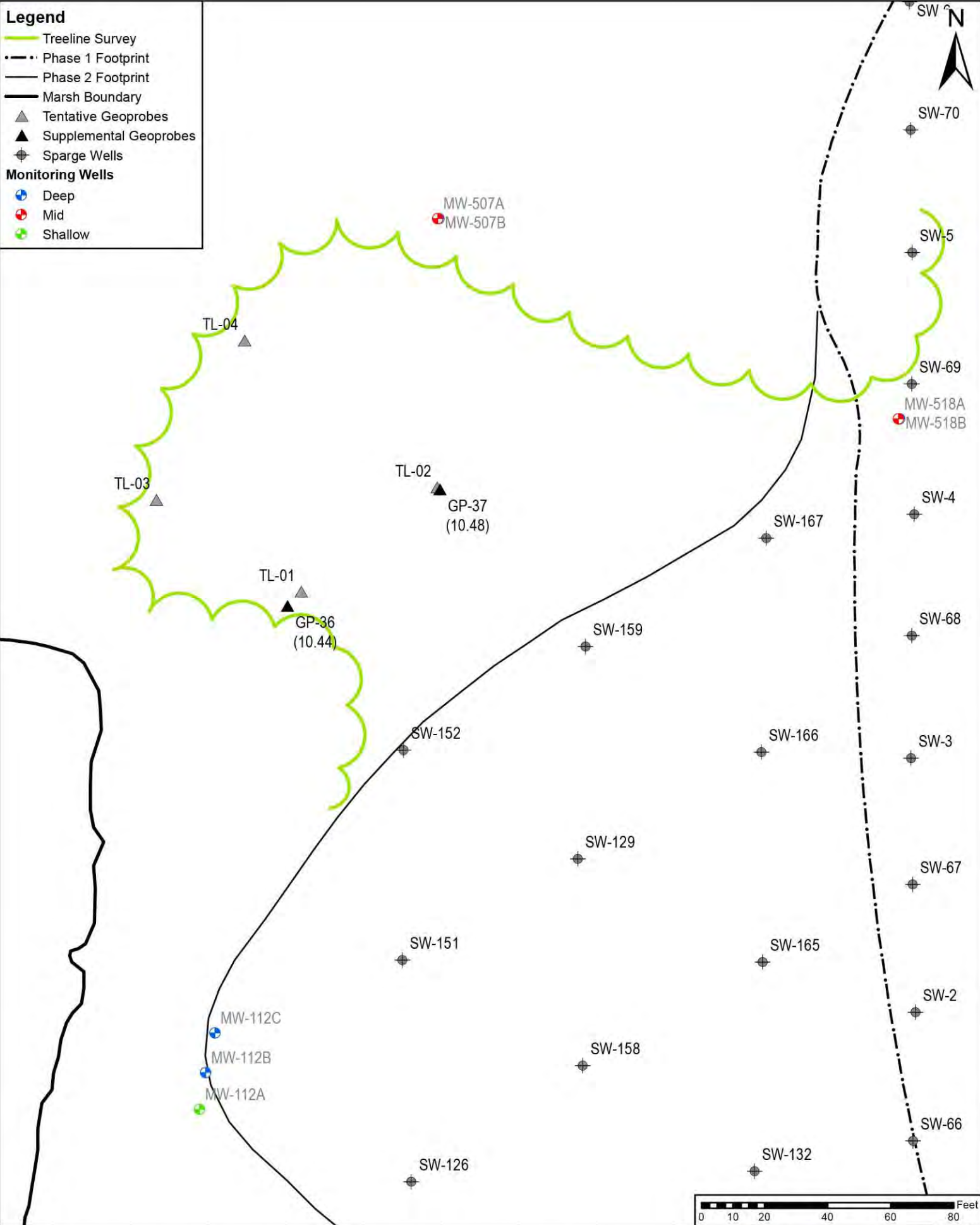

Figure 3-5: Supplemental Geoprobe sampling locations and results for pH
 LCP Chemicals Site, Brunswick, GA

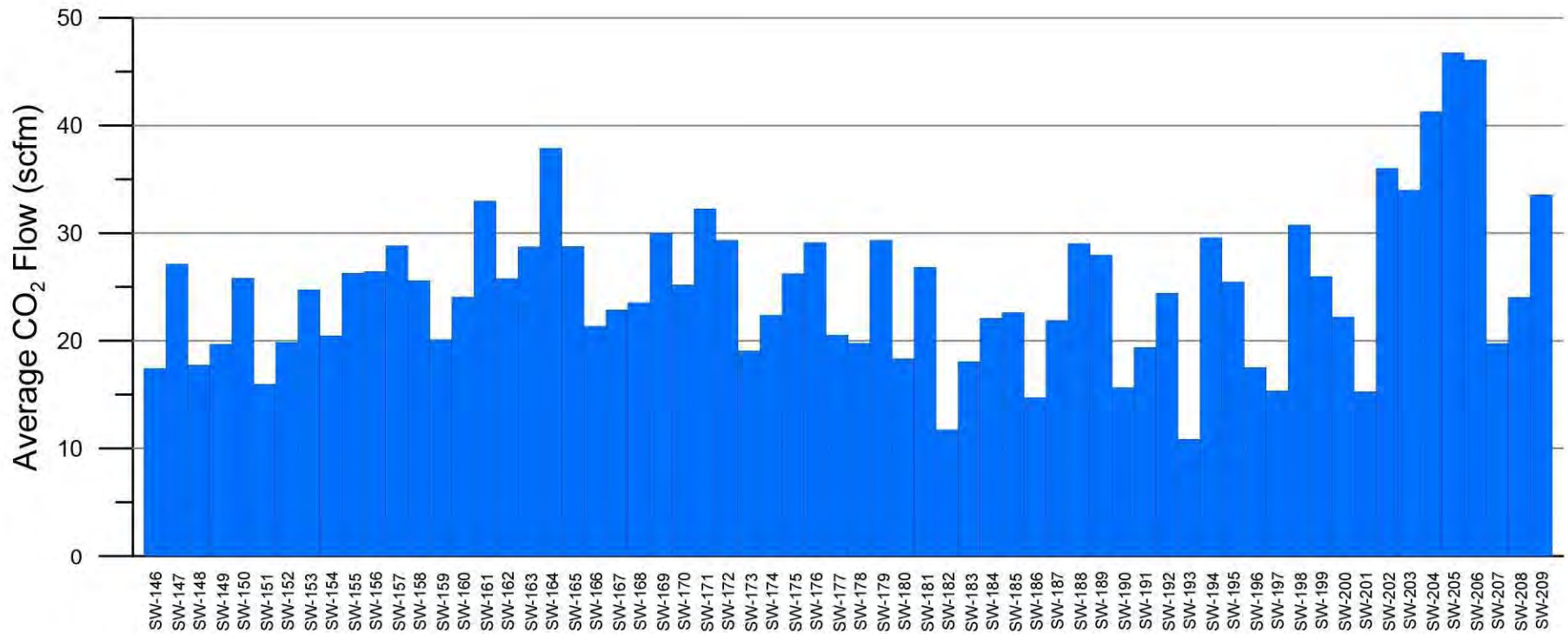

Figure 4-1: Average flow rates for Phase 3 sparge wells
 LCP Chemicals Site, Brunswick, GA

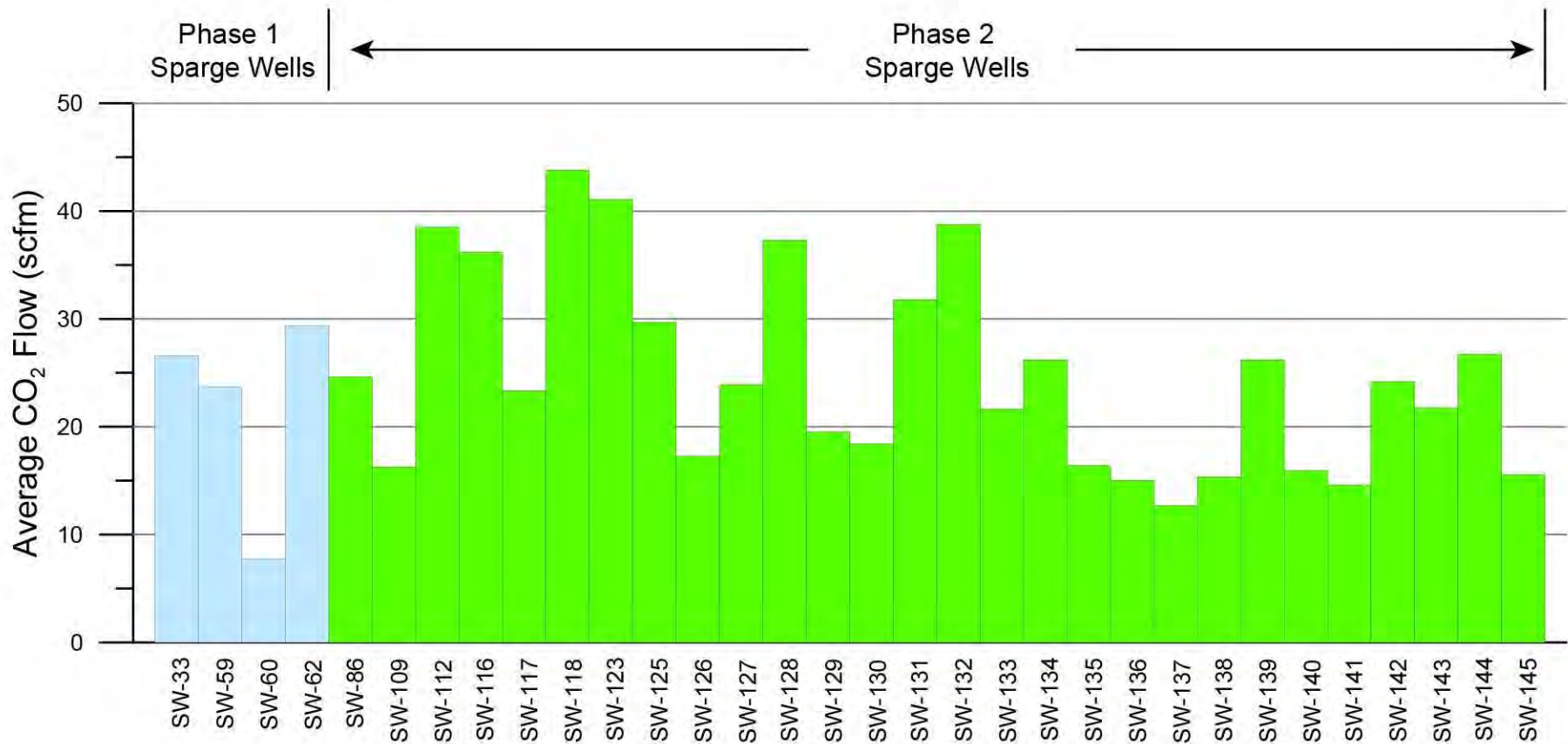

Figure 4-2: Average flow rates for Phase 1 and 2 sparge wells
 LCP Chemicals Site, Brunswick, GA

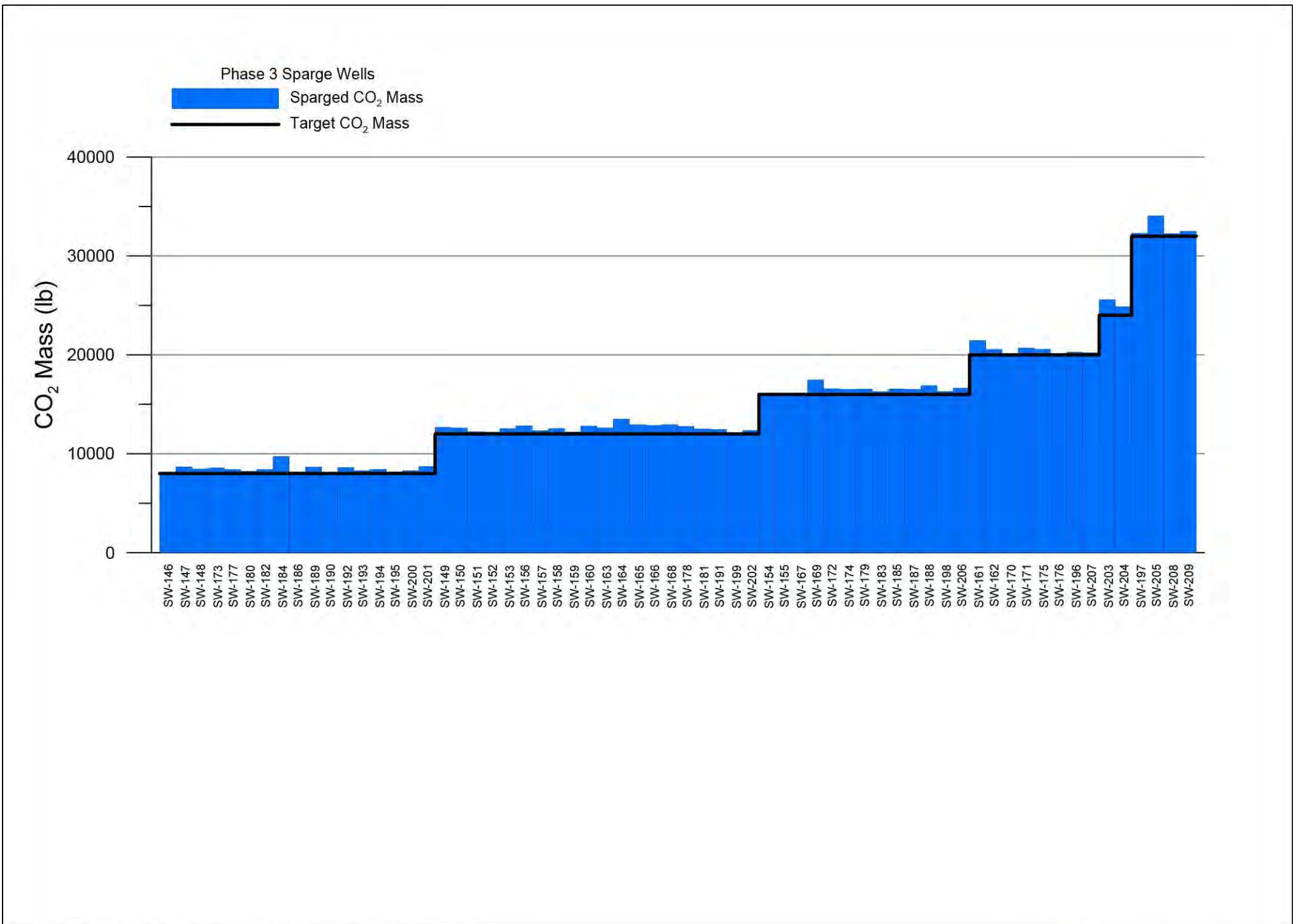

Figure 4-3: Total CO₂ mass for Phase 3 sparge wells
 LCP Chemicals Site, Brunswick, GA

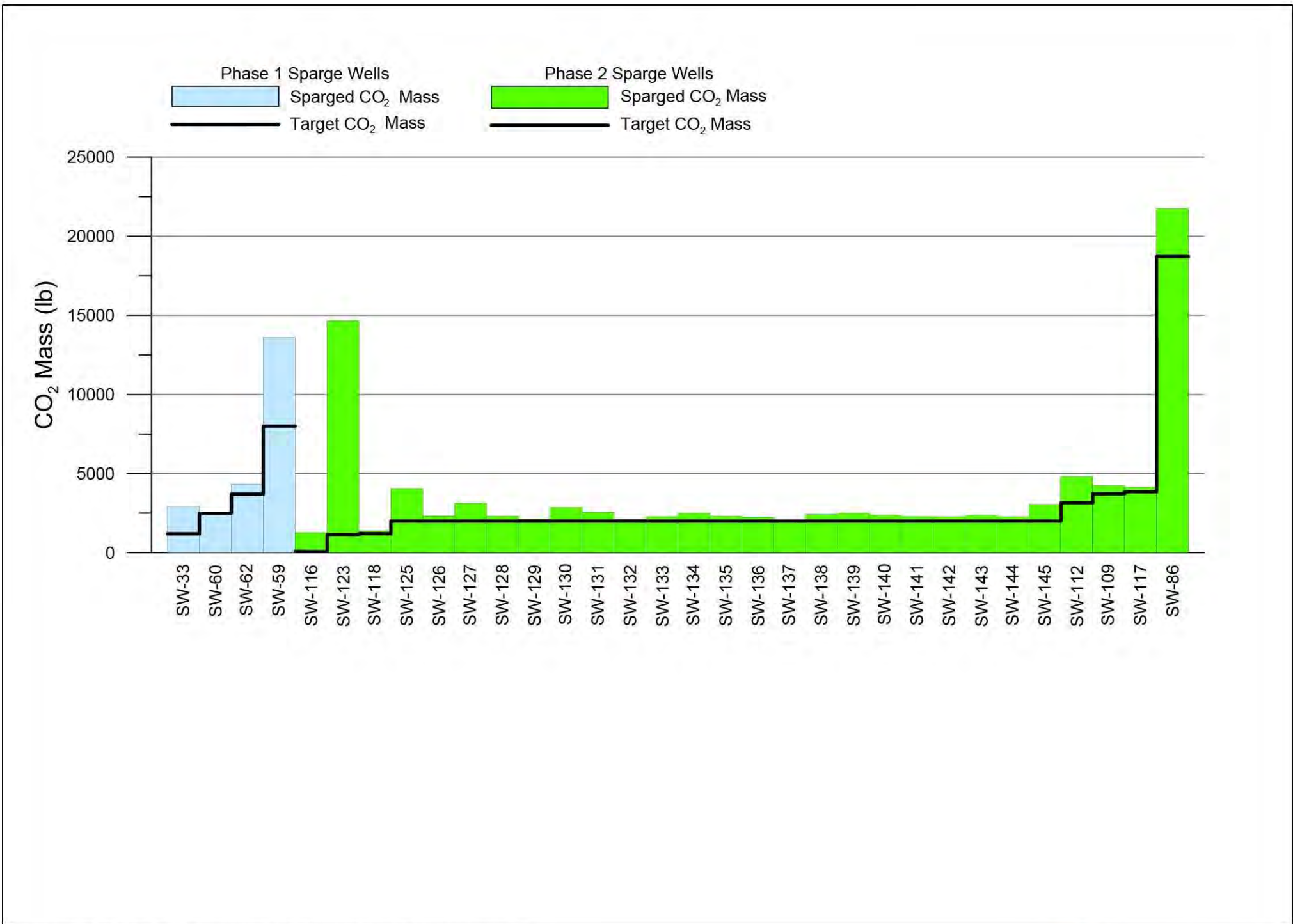

Figure 4-4: Total CO₂ mass for Phase 1 and 2 sparge wells
 LCP Chemicals Site, Brunswick, GA

- Legend**
- · - Phase 1 Footprint
 - Phase 2 Footprint
 - Historical Structures
 - Marsh Boundary
 - Infiltration Gallery
 - Elevated Pad

- pH**
- <6.5
 - 6.5-7.0
 - 7.0-8.0
 - 8.0-9.0
 - 9.0-10.0
 - 10.0-10.5
 - 10.5-11.0
 - 11.0-11.5
 - 11.5-12.0
 - >12

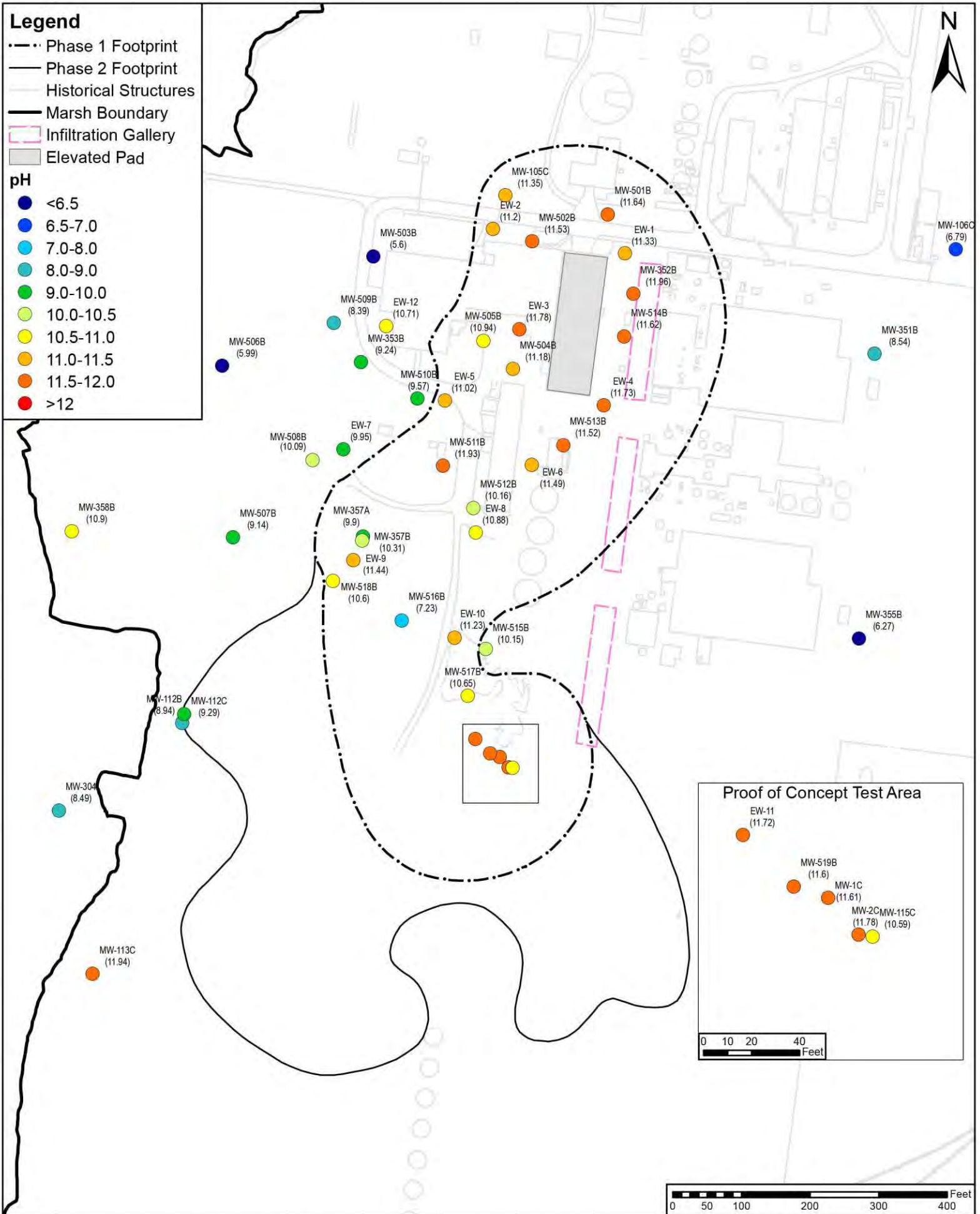

Figure 4-5: Pre-sparge (2011-2012) pH in deep Satilla monitoring and extraction wells LCP Chemicals Site, Brunswick, GA

- Legend**
- · - Phase 1 Footprint
 - Phase 2 Footprint
 - Historical Structures
 - Marsh Boundary
 - Infiltration Gallery
 - Elevated Pad

- pH**
- <6.5
 - 6.5-7.0
 - 7.0-8.0
 - 8.0-9.0
 - 9.0-10.0
 - 10.0-10.5
 - 10.5-11.0
 - 11.0-11.5
 - 11.5-12.0
 - >12

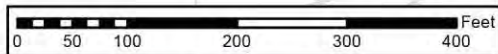
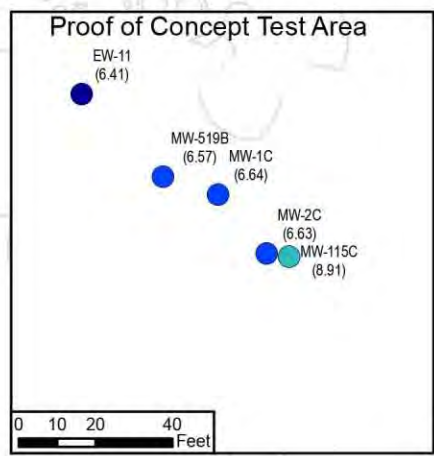
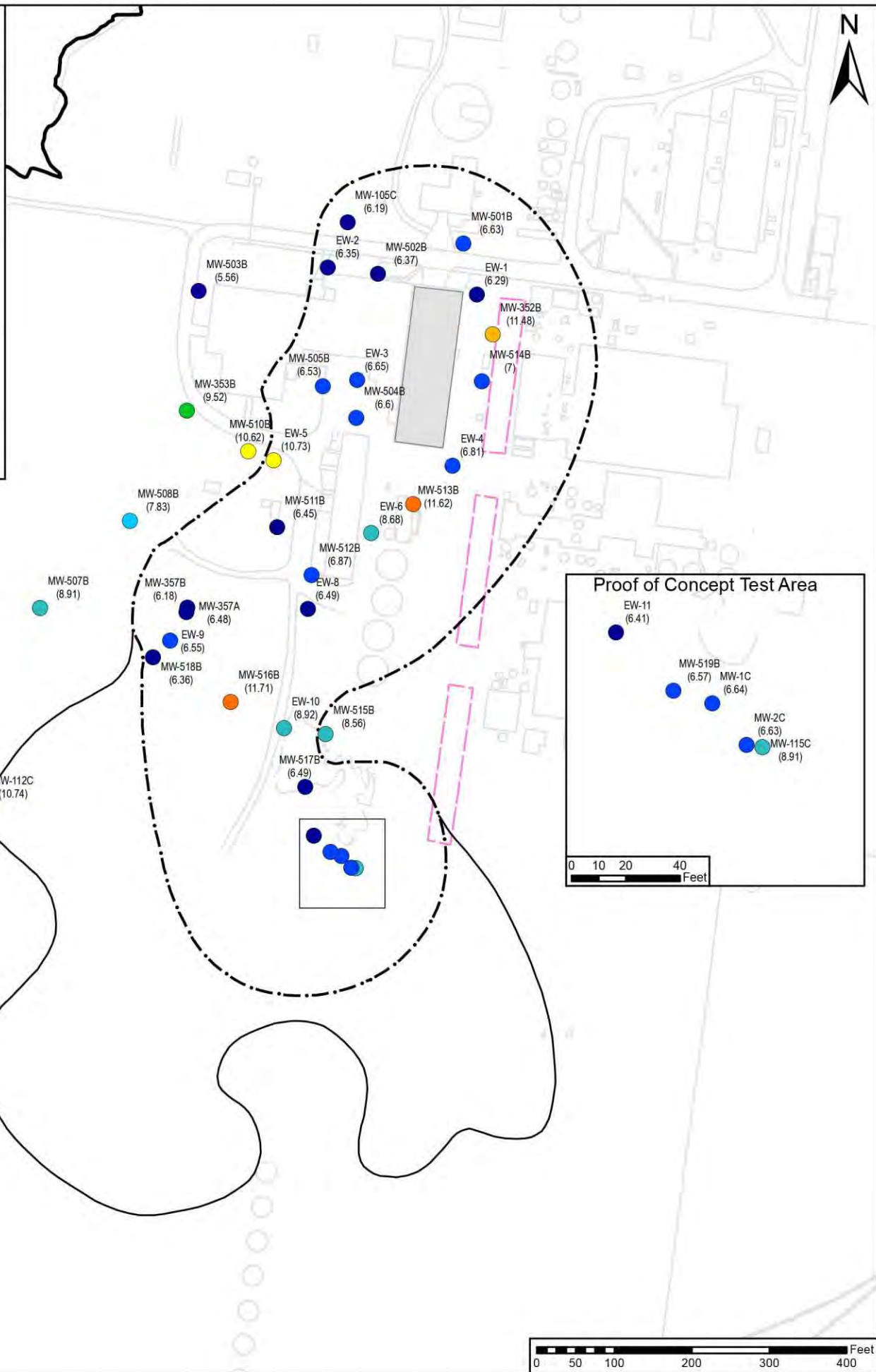

Figure 4-6: Pre-sparge (Phase 3) pH in deep Satilla monitoring and extraction wells
LCP Chemicals Site, Brunswick, GA

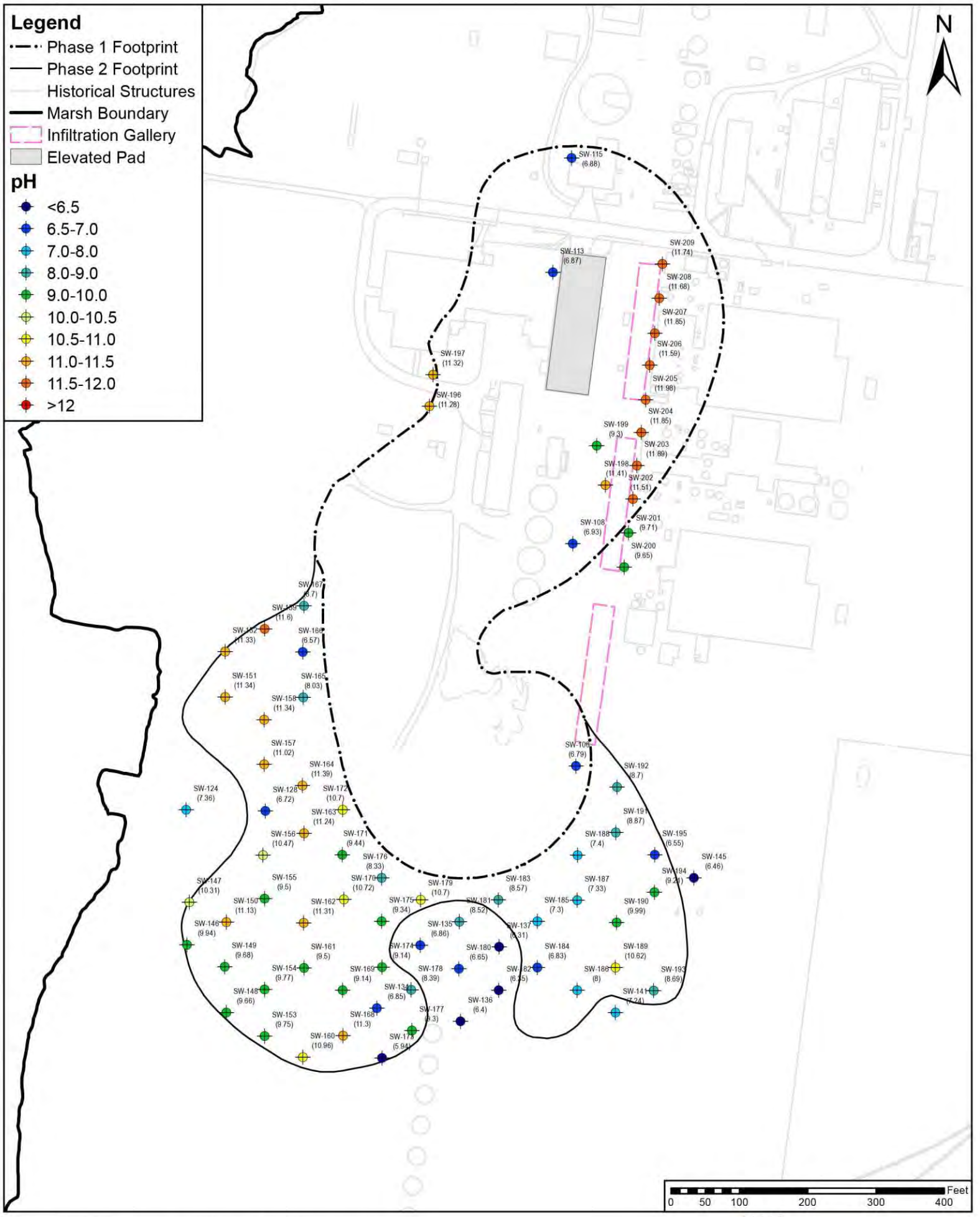

Figure 4-7: Pre-surge (Phase 3) pH in sparge wells
 LCP Chemicals Site, Brunswick, GA

Legend

- · - Phase 1 Footprint
- Phase 2 Footprint
- Historical Structures
- Marsh Boundary
- Infiltration Gallery
- Elevated Pad

pH

- <6.5
- 6.5-7.0
- 7.0-8.0
- 8.0-9.0
- 9.0-10.0
- 10.0-10.5
- 10.5-11.0
- 11.0-11.5
- 11.5-12.0
- >12
- Not Sampled

- Monitoring point
- ⊕ Sparge well

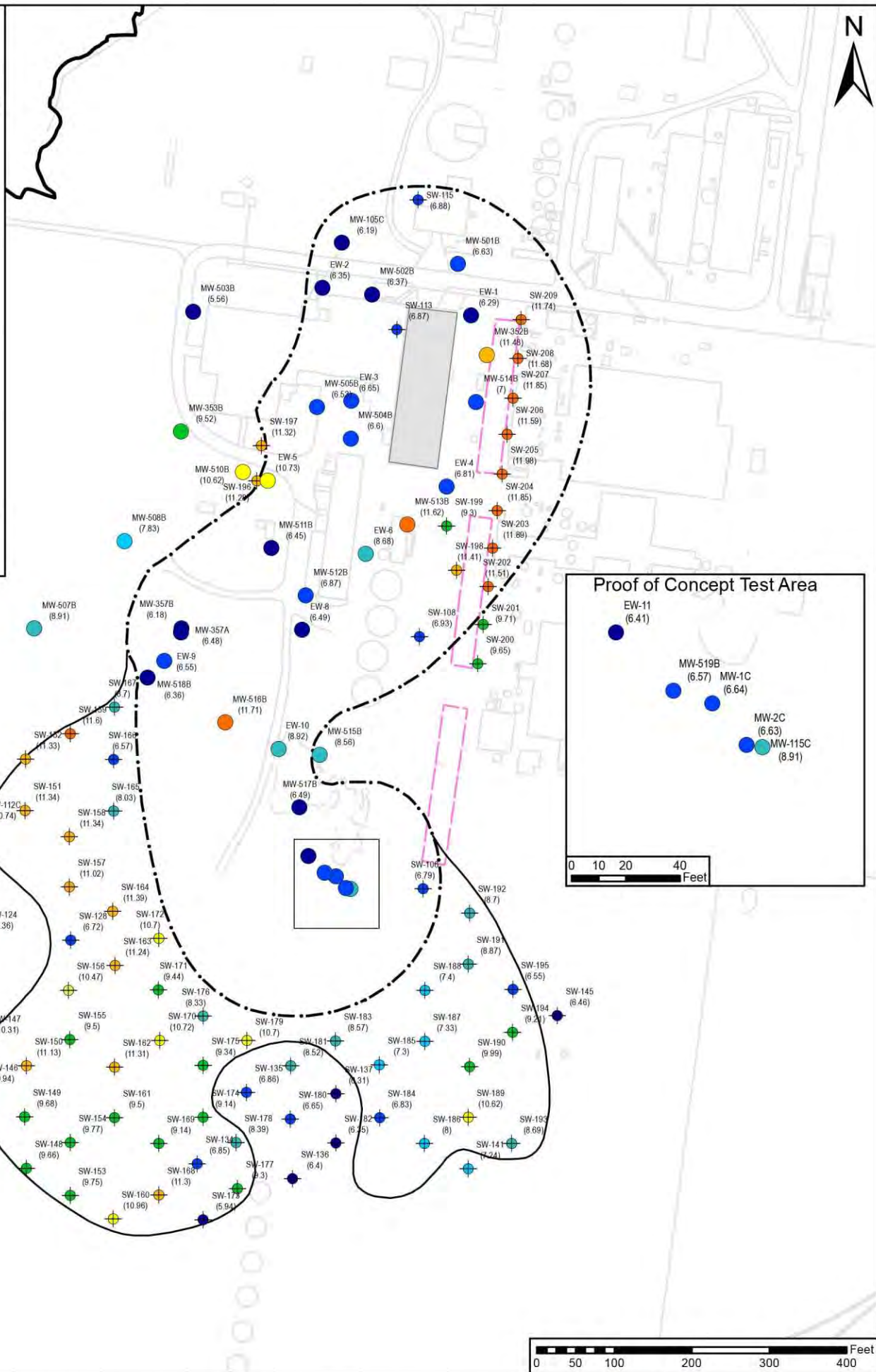

Figure 4-8: Pre-sparge (Phase 3) pH in deep Satilla monitoring, extraction and sparge wells

LCP Chemicals Site, Brunswick, GA

- Legend**
- · - Phase 1 Footprint
 - Phase 2 Footprint
 - Historical Structures
 - Marsh Boundary
 - Infiltration Gallery
 - Elevated Pad

- pH**
- <6.5
 - 6.5-7.0
 - 7.0-8.0
 - 8.0-9.0
 - 9.0-10.0
 - 10.0-10.5
 - 10.5-11.0
 - 11.0-11.5
 - 11.5-12.0
 - >12

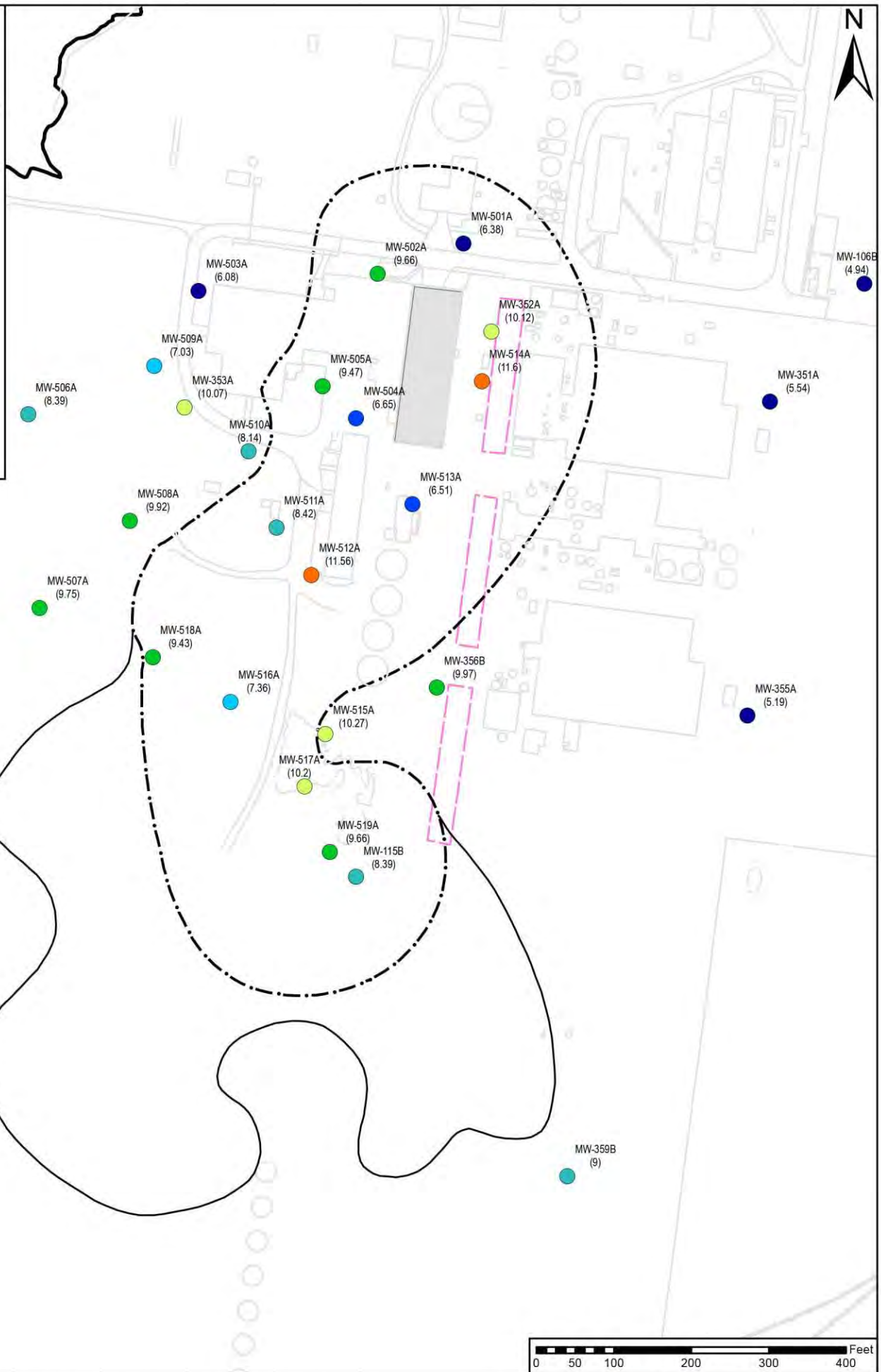

Figure 4-9: Pre-sparge (2012) pH in mid Satilla monitoring wells
 LCP Chemicals Site, Brunswick, GA

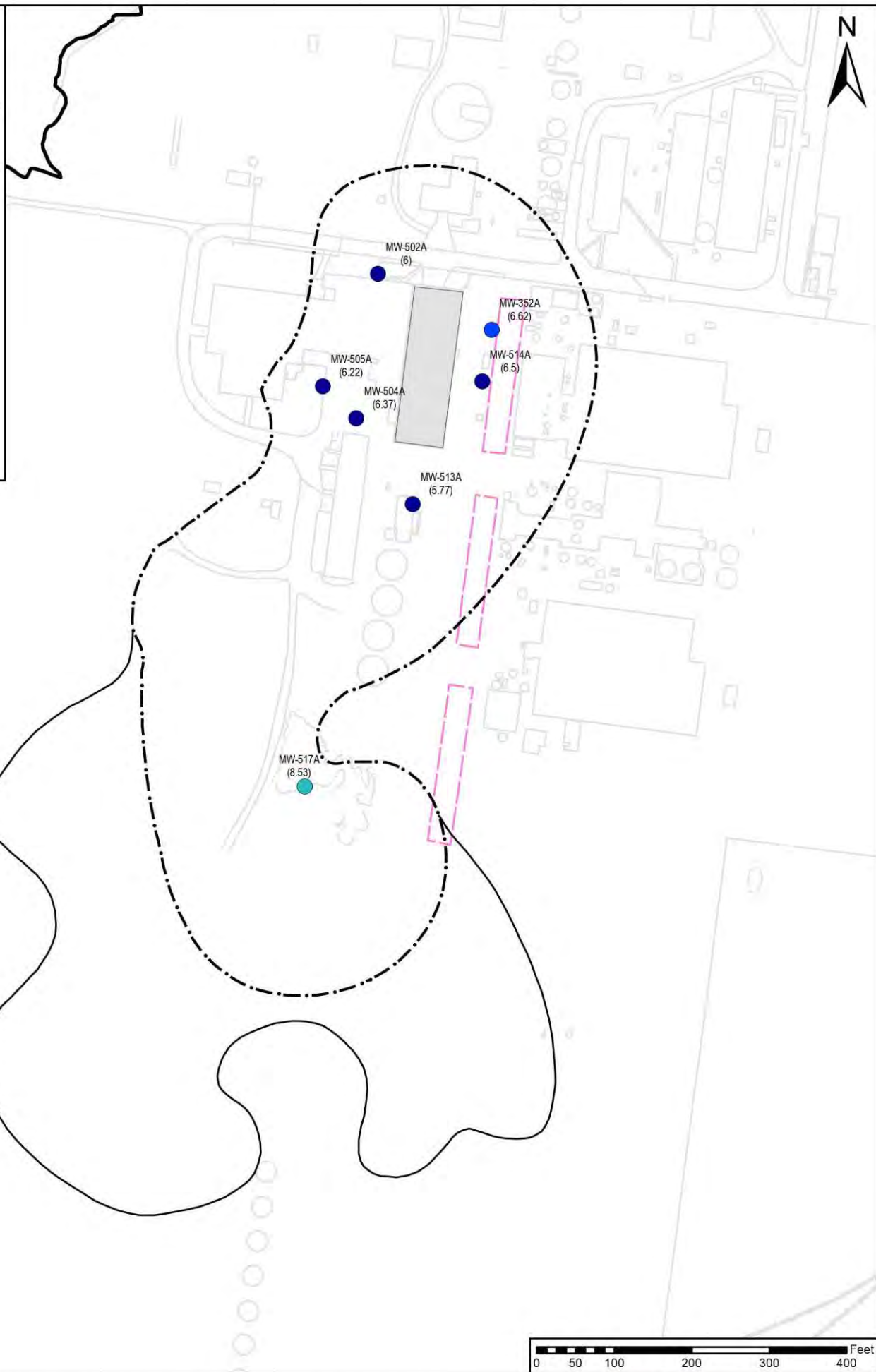
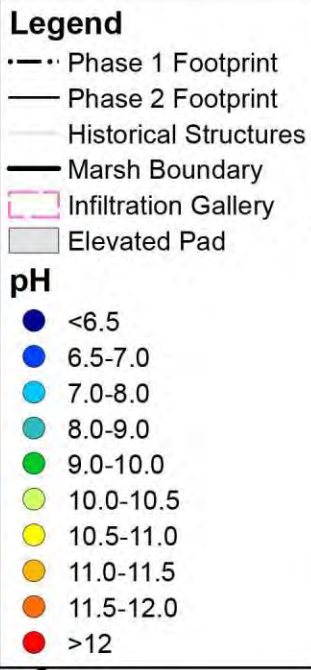

Figure 4-10: Pre-sparge (Phase 3) pH in mid Satilla monitoring locations
LCP Chemicals Site, Brunswick, GA

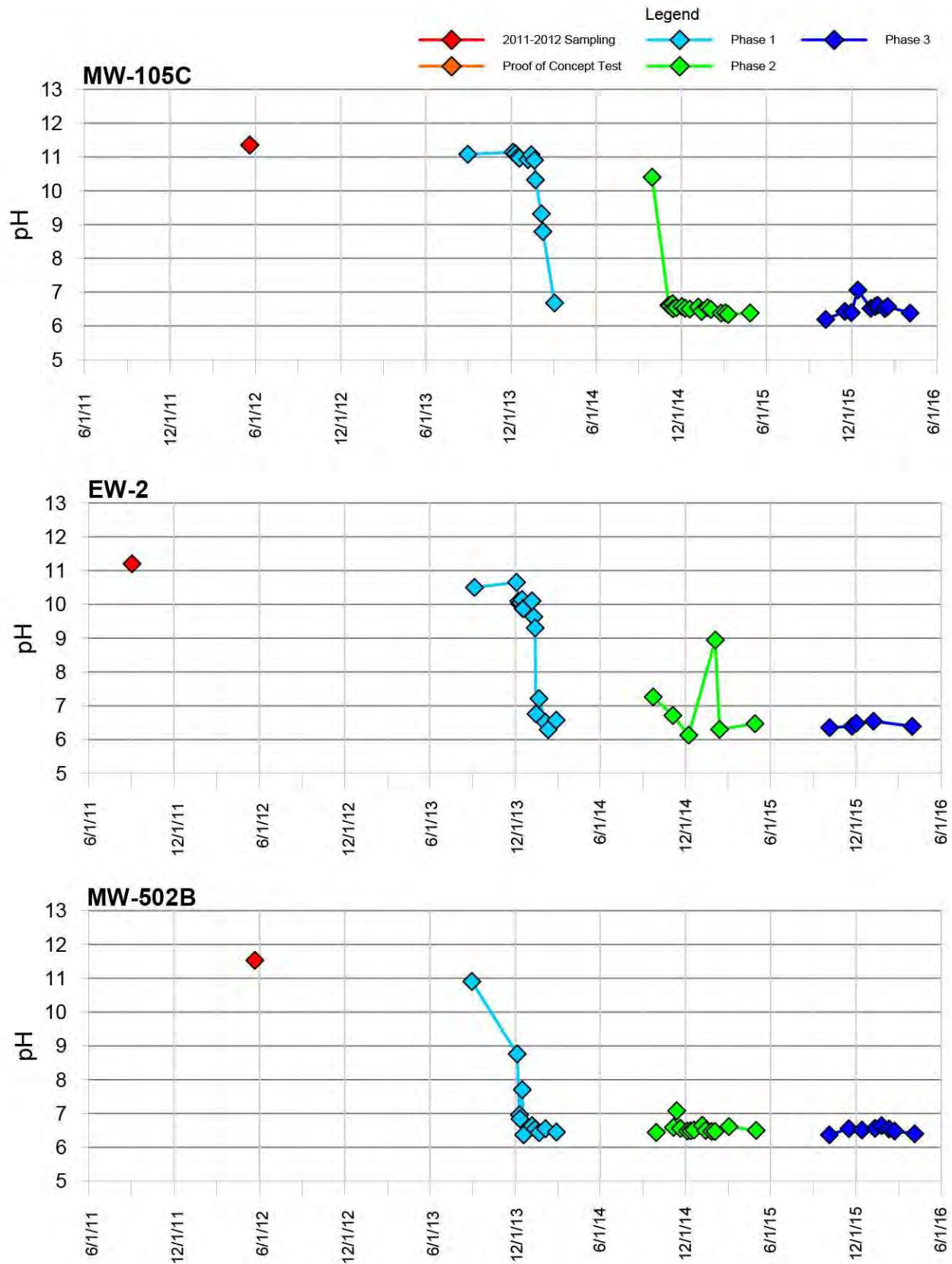

Figure 4-11: pH as a function of time for MW-105C, EW-2 and MW-502B during 2012 and Phase 1-3 sparging
 LCP Chemicals Site, Brunswick, GA

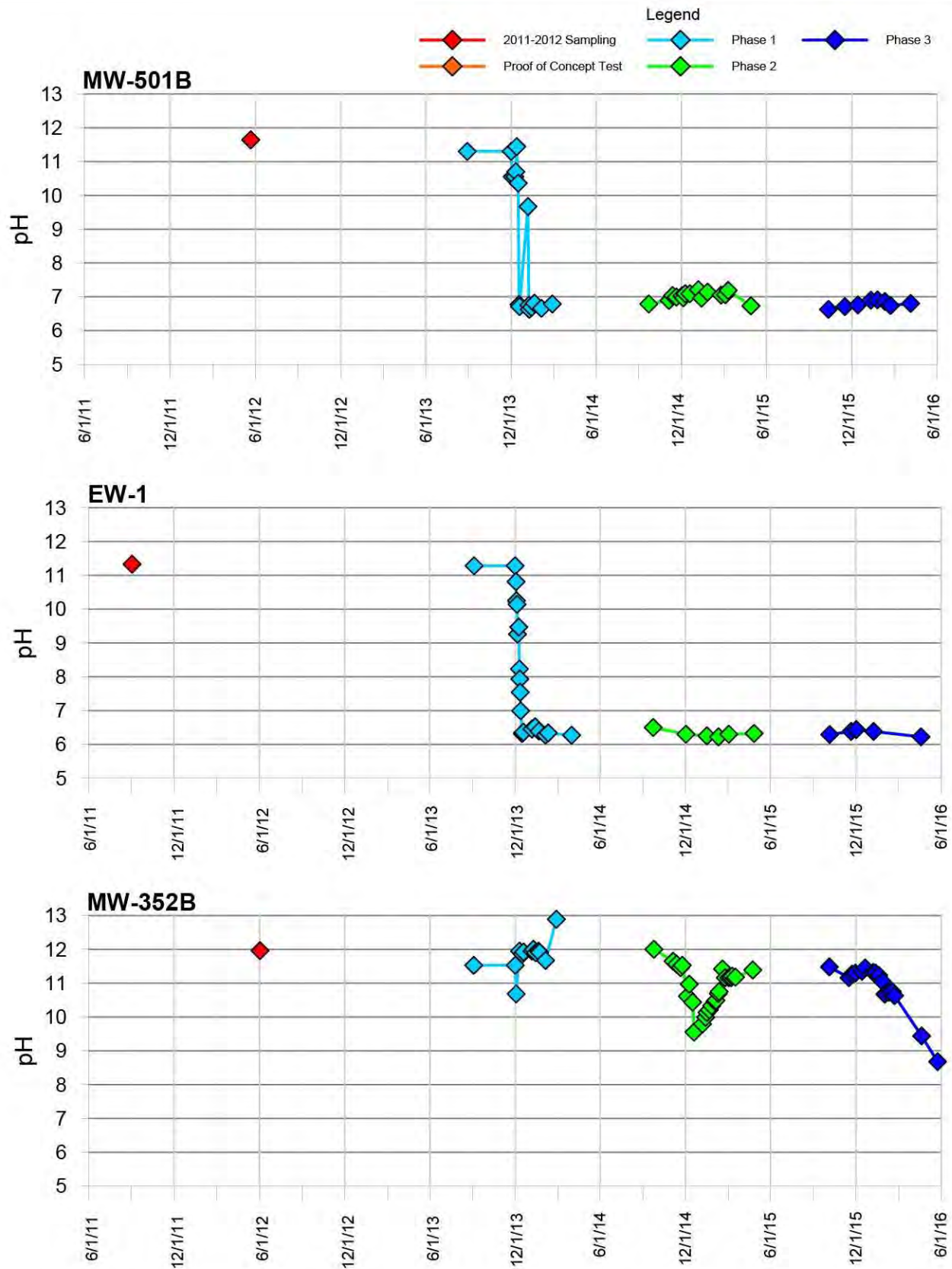

Figure 4-12: pH as a function of time for MW-501B, EW-1 and MW-352B during 2012 and Phase 1-3 sparging
 LCP Chemicals Site, Brunswick, GA

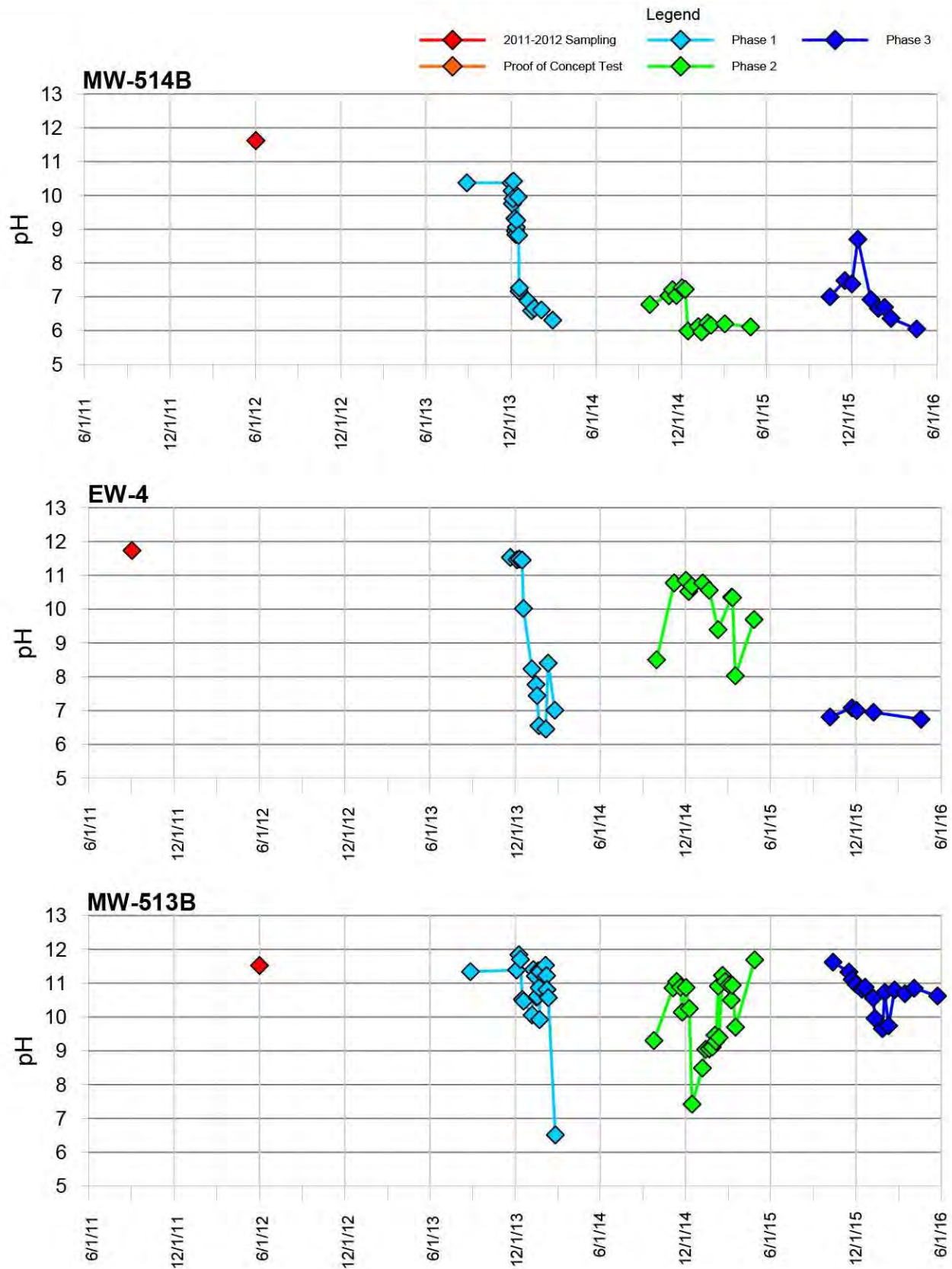

Figure 4-13: pH as a function of time for MW-514B, EW-4 and MW-513B during 2012 and Phase 1-3 Sparging
 LCP Chemicals Site, Brunswick, GA

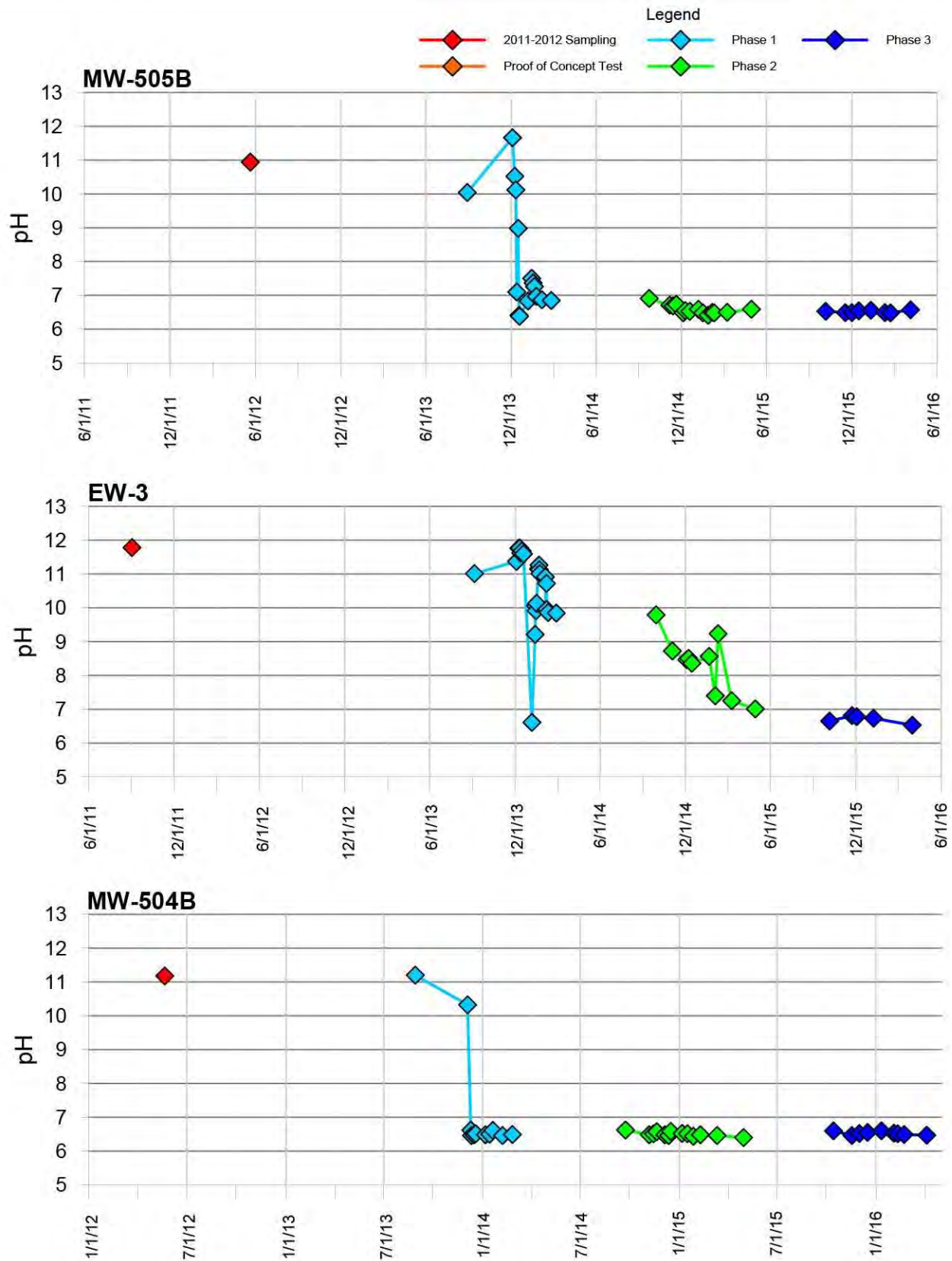

Figure 4-14: pH as a function of time for MW-505B, EW-3 and MW-504B during 2012 and Phase 1-3 Sparging
 LCP Chemicals Site, Brunswick, GA

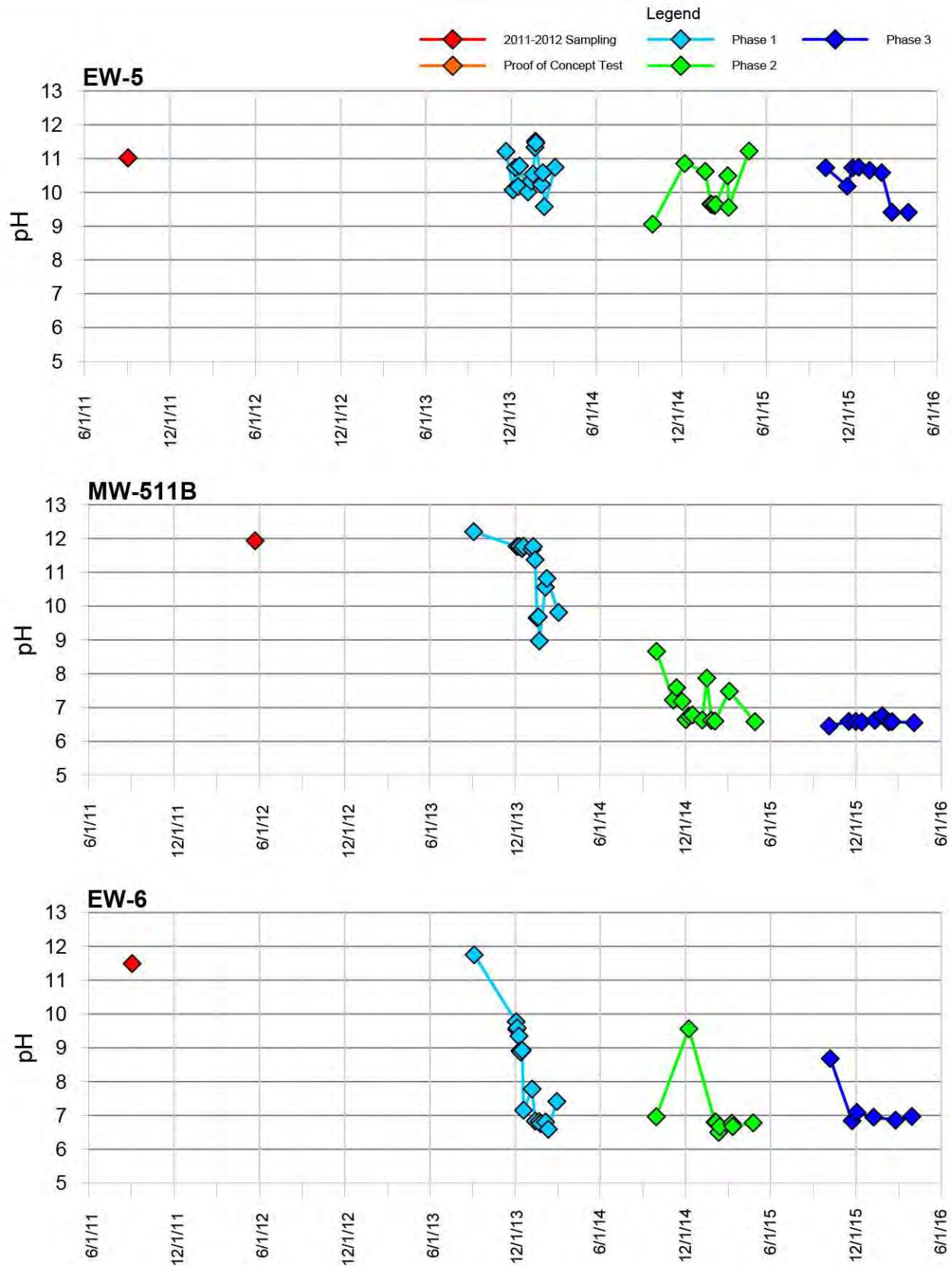

Figure 4-15: pH as a function of time for EW-5, MW-511B and EW-6 during 2012 and Phase 1-3 Sparging
 LCP Chemicals Site, Brunswick, GA

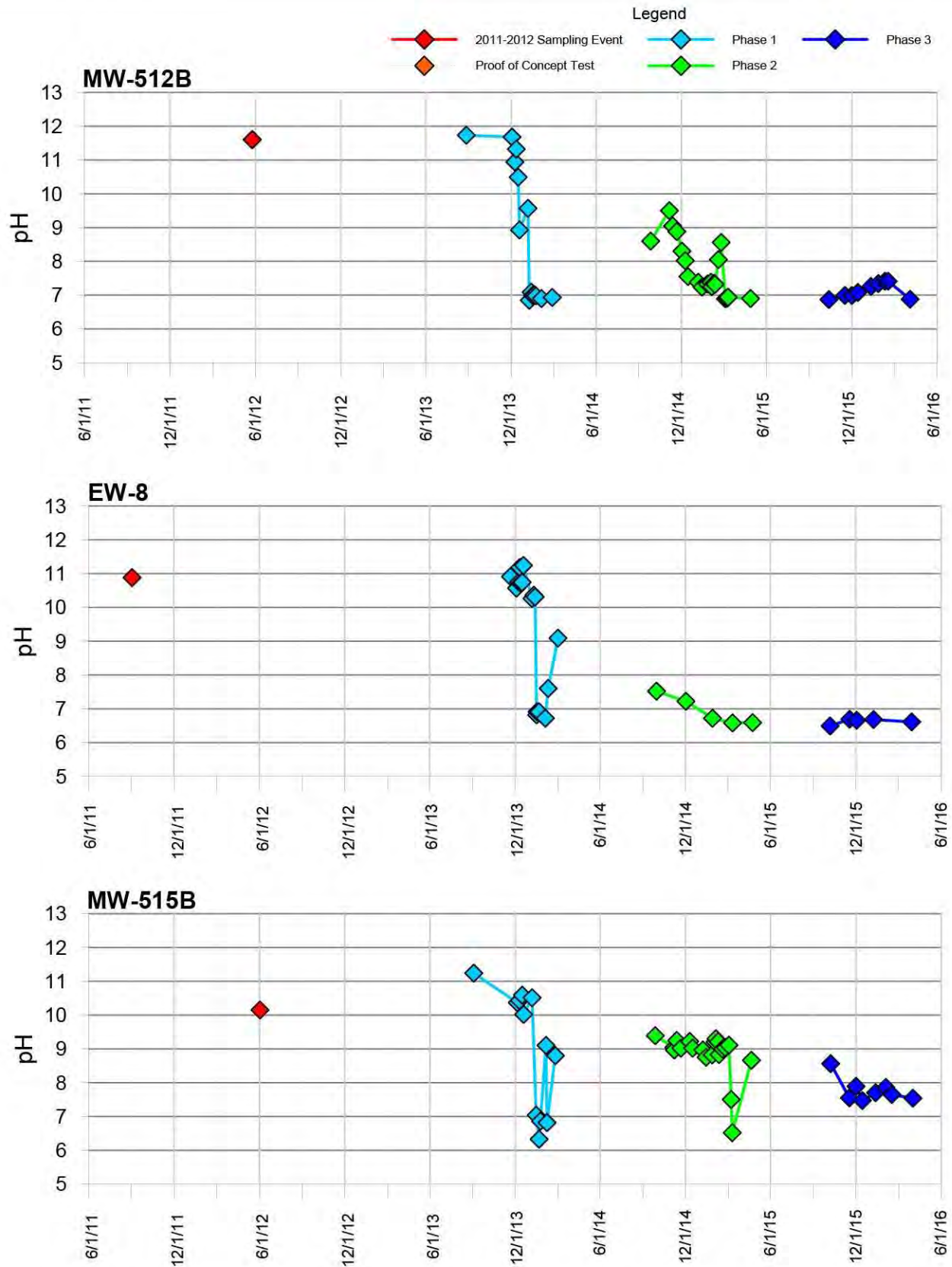

Figure 4-16: pH as a function of time for MW-512B, EW-8 and MW-515B during 2012 and Phase 1-3 Sparging
 LCP Chemicals Site, Brunswick, GA

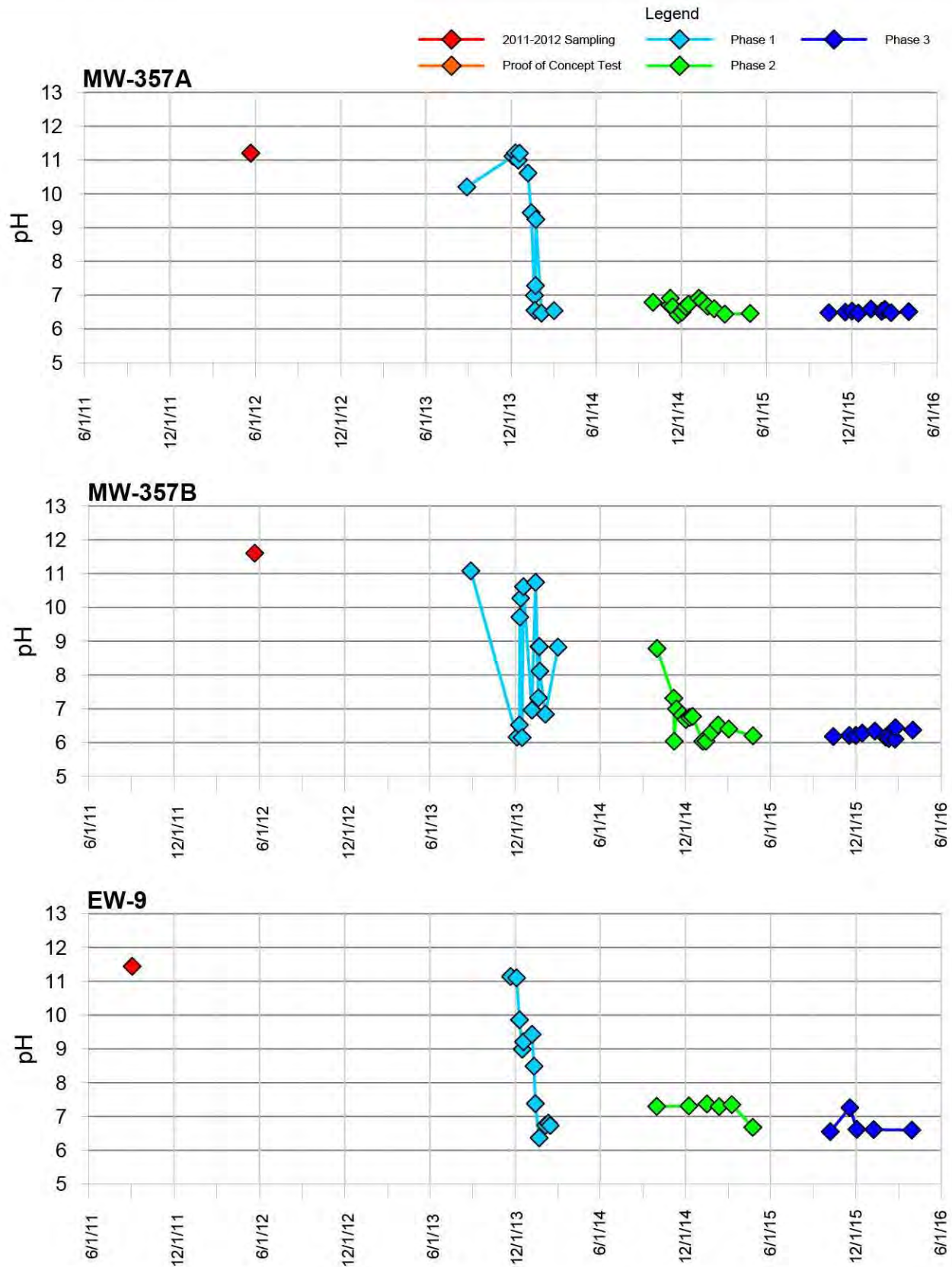

Figure 4-17: pH as a function of time for MW-357A, MW-357B and EW-9 during 2012 and Phase 1-3 Sparging
 LCP Chemicals Site, Brunswick, GA

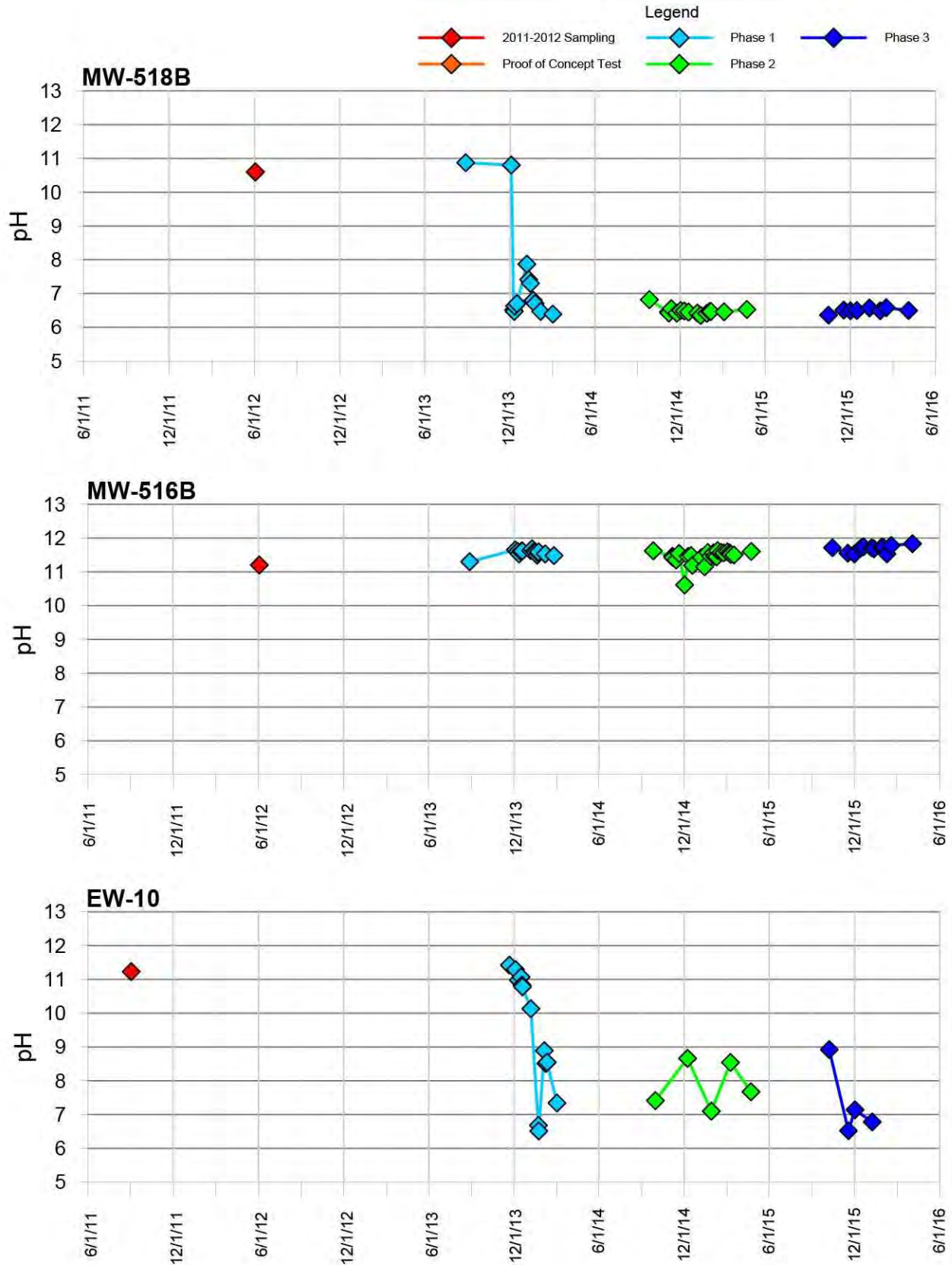

Figure 4-18: pH as a function of time for MW-518B, MW-516B and EW-10 during 2012 and Phase 1-3 Sparging
LCP Chemicals Site, Brunswick, GA

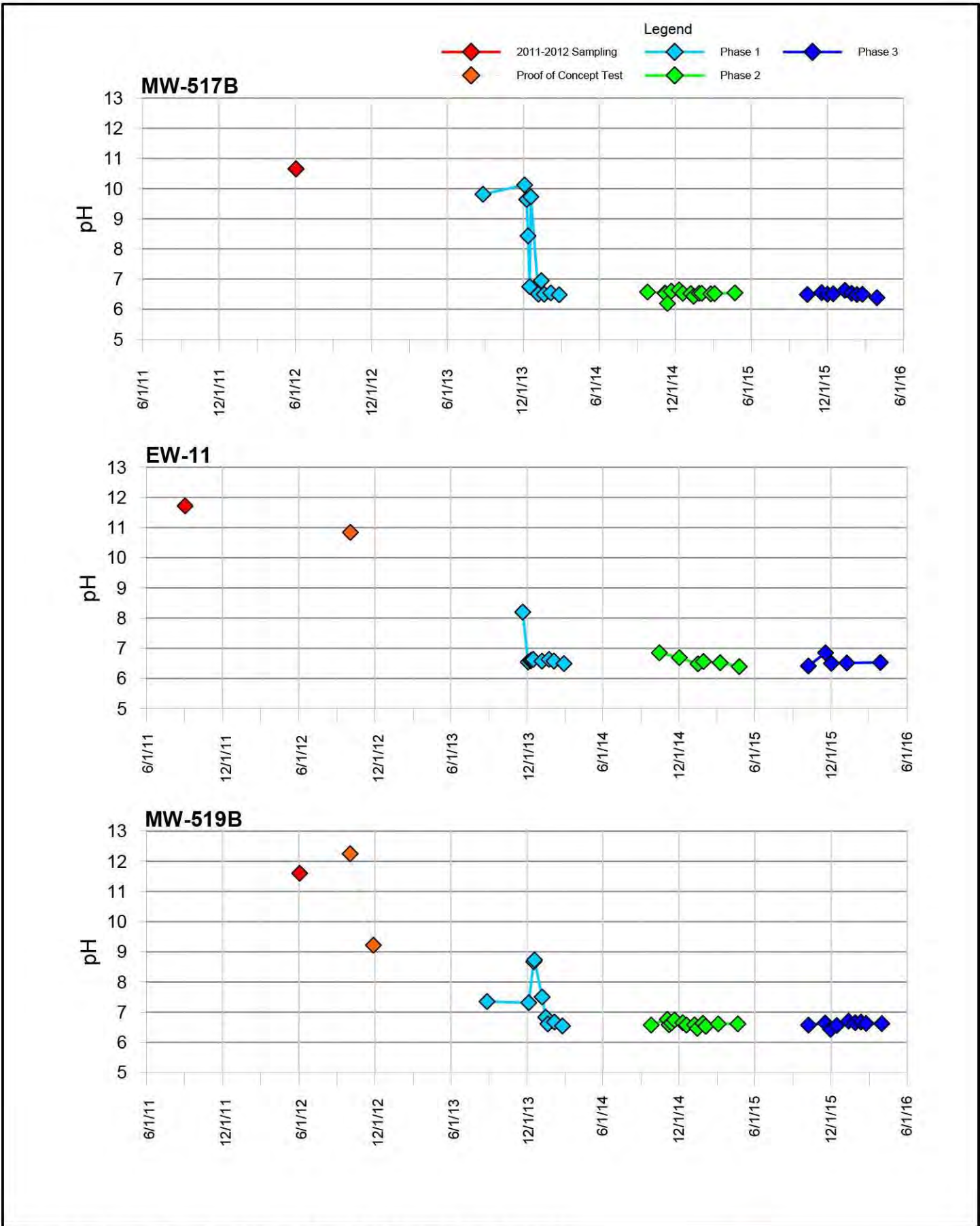

Figure 4-19: pH as a function of time for MW-517B, EW-11 and MW-519B during 2012 and Phase 1-3 Sparging
 LCP Chemicals Site, Brunswick, GA

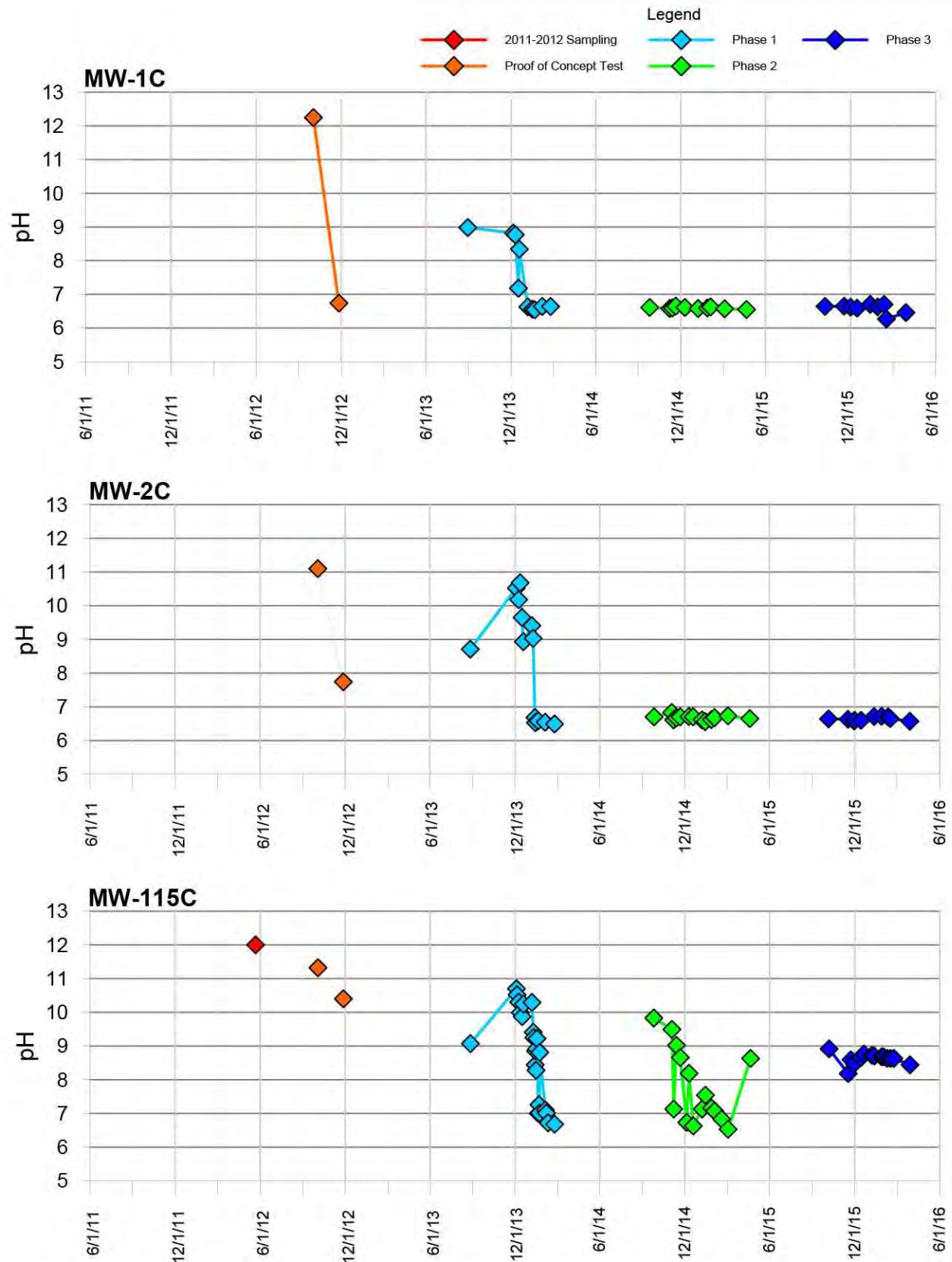

Figure 4-20: pH as a function of time for MW-1C, MW-2C and MW-115C during 2012 and Phase 1-3 Sparging
LCP Chemicals Site, Brunswick, GA

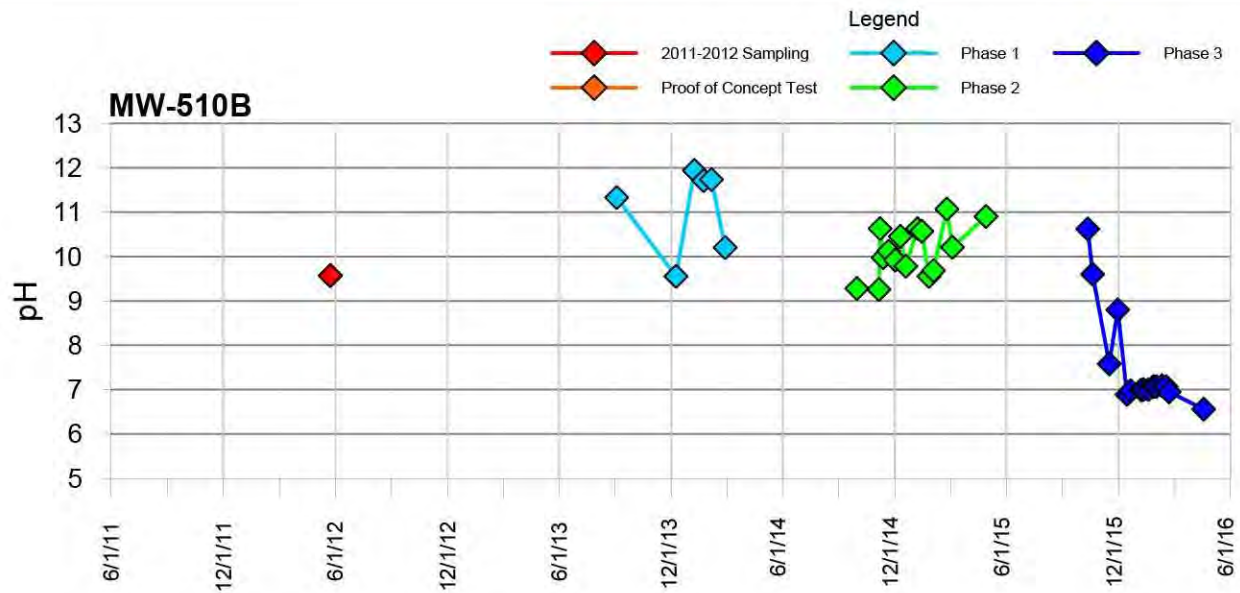

Figure 4-21: pH as a function of time for MW-510B during 2012 and Phase 1-3 Sparging
 LCP Chemicals Site, Brunswick, GA

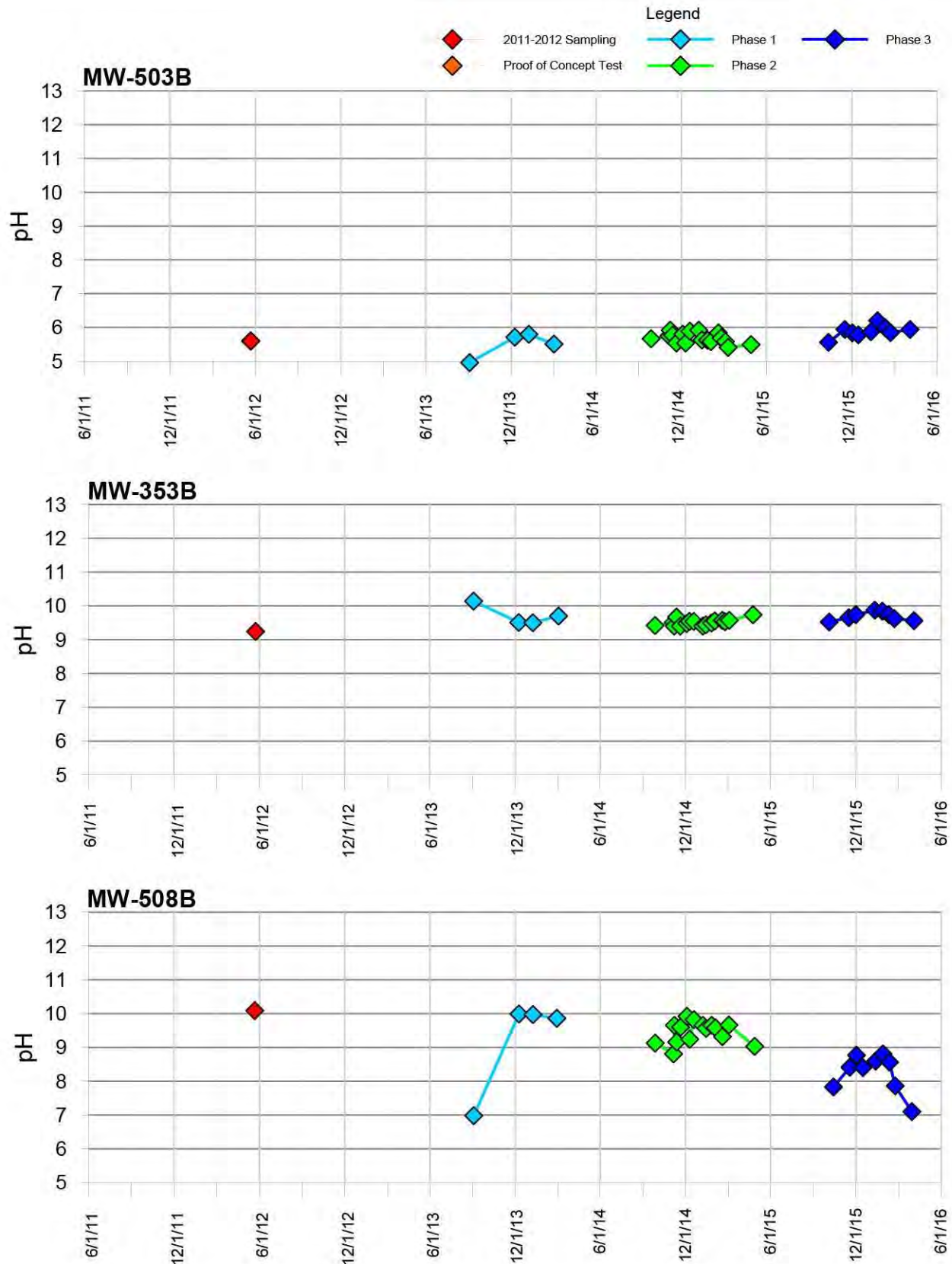

Figure 4-22: pH as a function of time for MW-503B, MW-353B and MW-508B during 2012 and Phase 1-3 Sparging
 LCP Chemicals Site, Brunswick, GA

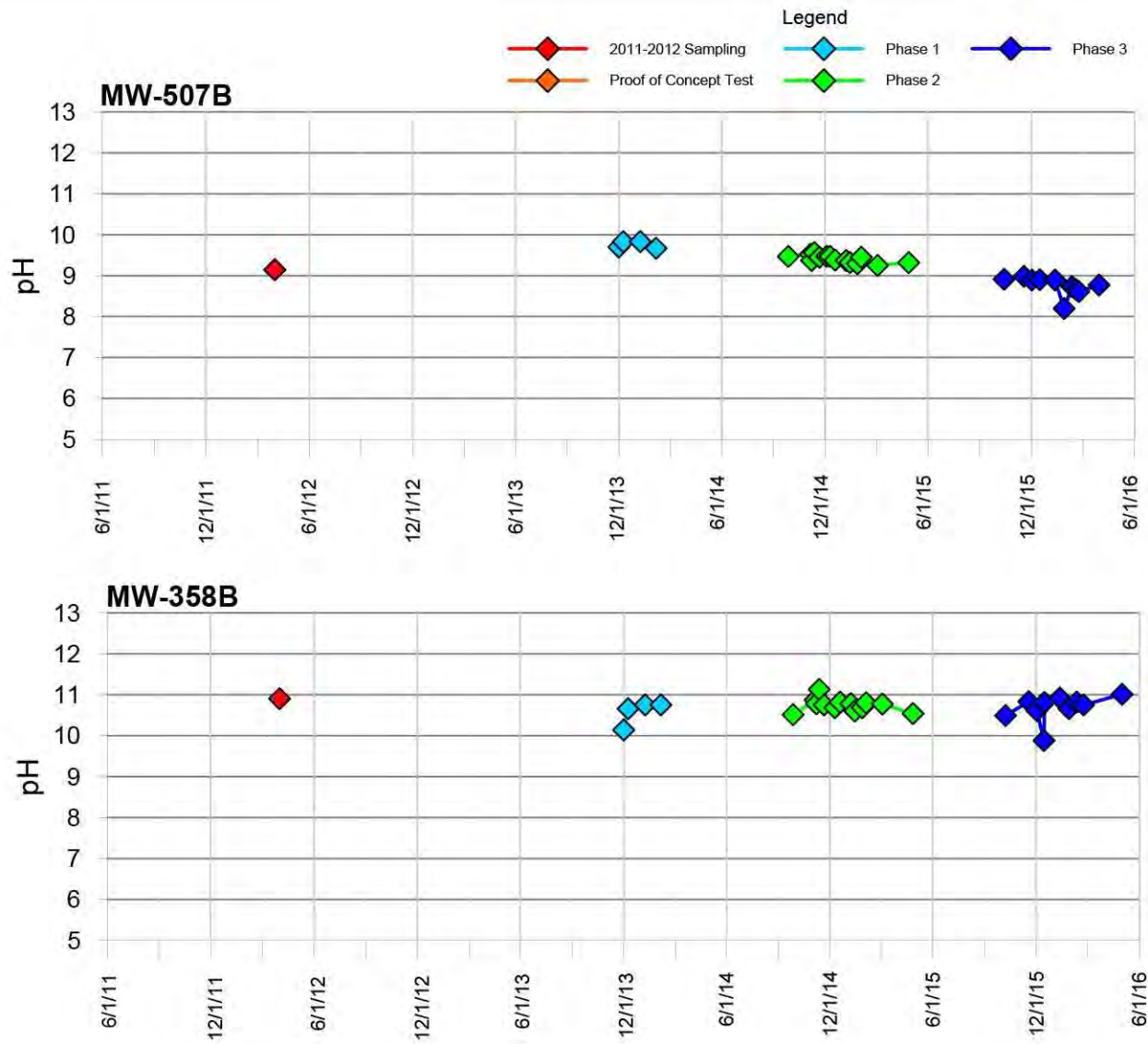

Figure 4-23: pH as a function of time for MW-507B and MW-358B during 2012 and Phase 1-3 Sparging
 LCP Chemicals Site, Brunswick, GA

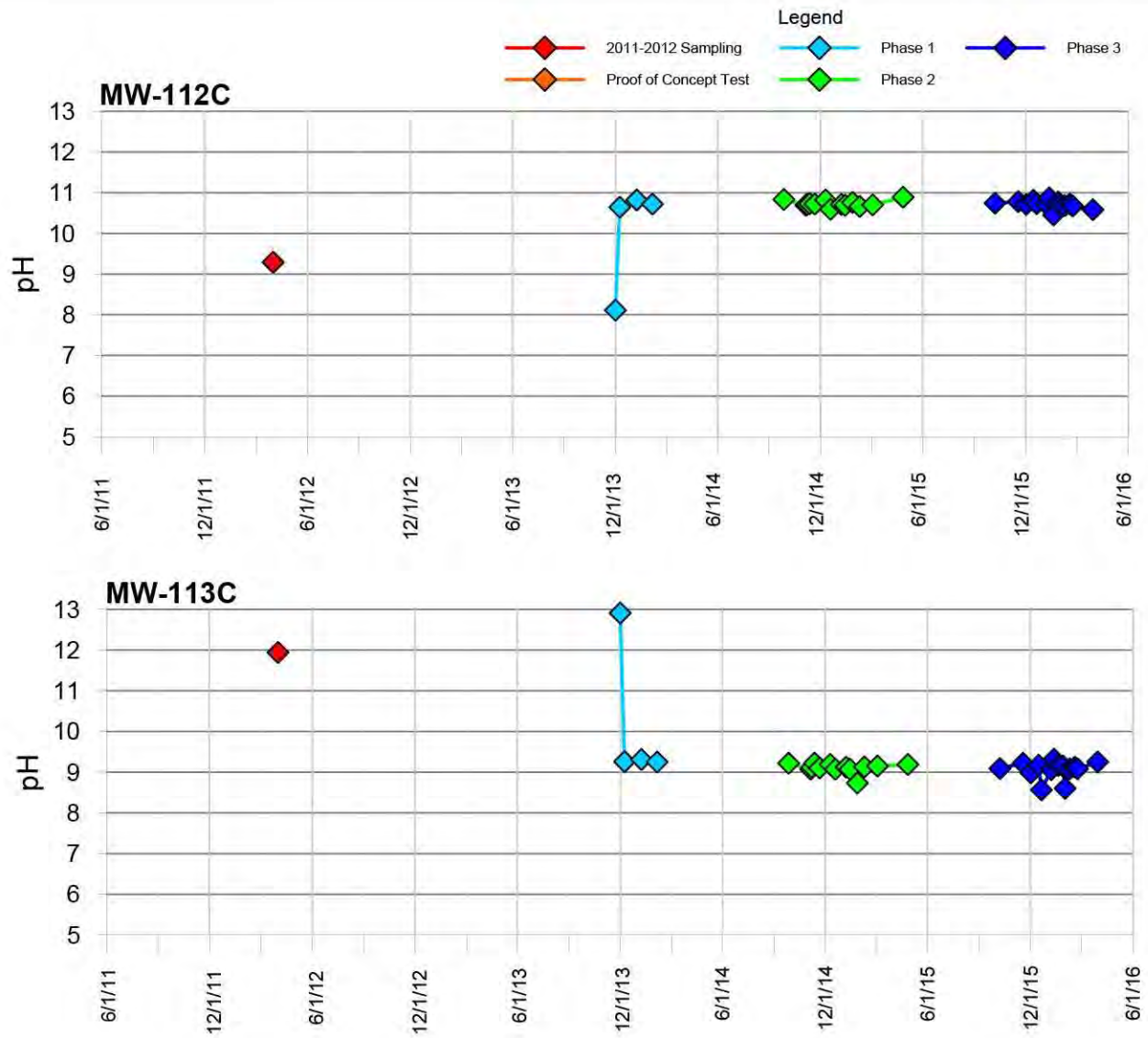

Figure 4-24: pH as a function of time for MW-112C and MW-113C during 2012 and Phase 1-3 Sparging
LCP Chemicals Site, Brunswick, GA

Legend

- · - Phase 1 Footprint
- Phase 2 Footprint
- Historical Structures
- Marsh Boundary
- Infiltration Gallery
- Elevated Pad

pH

- <6.5
- 6.5-7.0
- 7.0-8.0
- 8.0-9.0
- 9.0-10.0
- 10.0-10.5
- 10.5-11.0
- 11.0-11.5
- 11.5-12.0
- >12
- Not Sampled

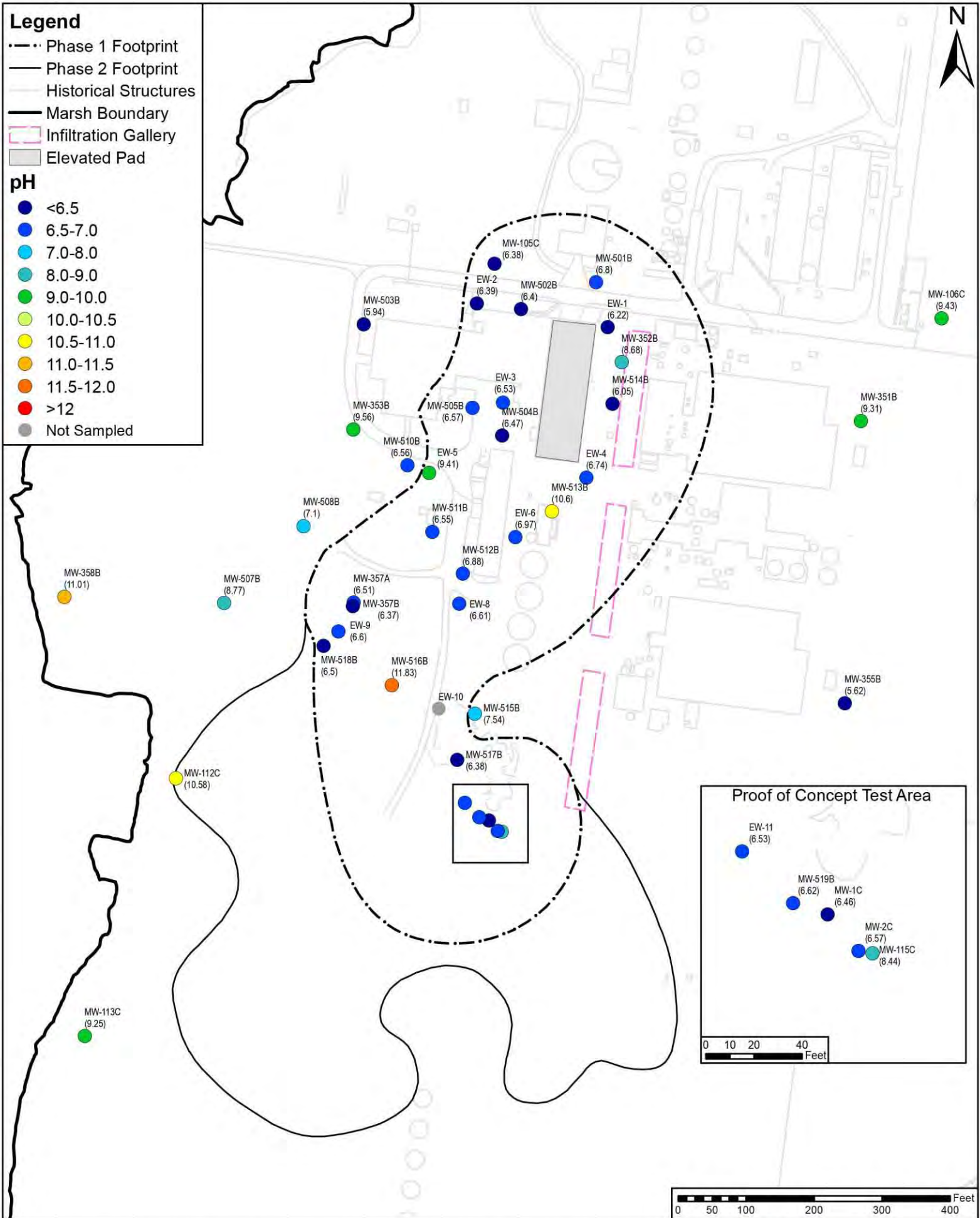

Figure 4-25: Post-sparge (Phase 3) pH in deep Satilla monitoring and extraction wells
LCP Chemicals Site, Brunswick, GA

- Legend**
- - - Phase 1 Footprint
 - Phase 2 Footprint
 - Historical Structures
 - Marsh Boundary
 - Infiltration Gallery
 - Elevated Pad

- pH**
- <6.5
 - 6.5-7.0
 - 7.0-8.0
 - 8.0-9.0
 - 9.0-10.0
 - 10.0-10.5
 - 10.5-11.0
 - 11.0-11.5
 - 11.5-12.0
 - >12

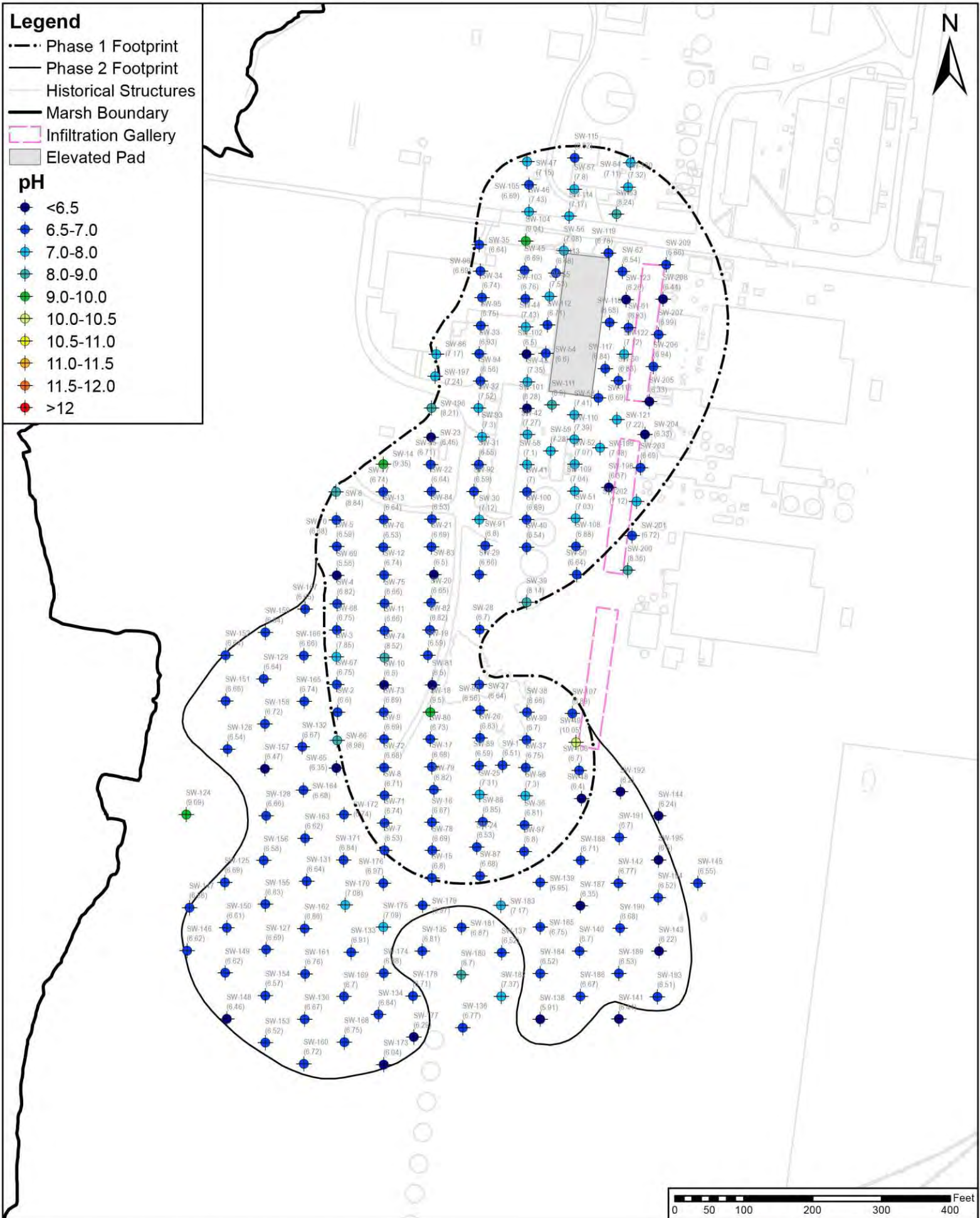

Figure 4-26: Post-sparge (Phase 3) pH in sparge wells
LCP Chemicals Site, Brunswick, GA

Legend

- · - Phase 1 Footprint
- Phase 2 Footprint
- Historical Structures
- Marsh Boundary
- Infiltration Gallery
- Elevated Pad

pH

- <6.5
- 6.5-7.0
- 7.0-8.0
- 8.0-9.0
- 9.0-10.0
- 10.0-10.5
- 10.5-11.0
- 11.0-11.5
- 11.5-12.0
- >12
- Not Sampled

- Monitoring point
- ⊕ Sparge well

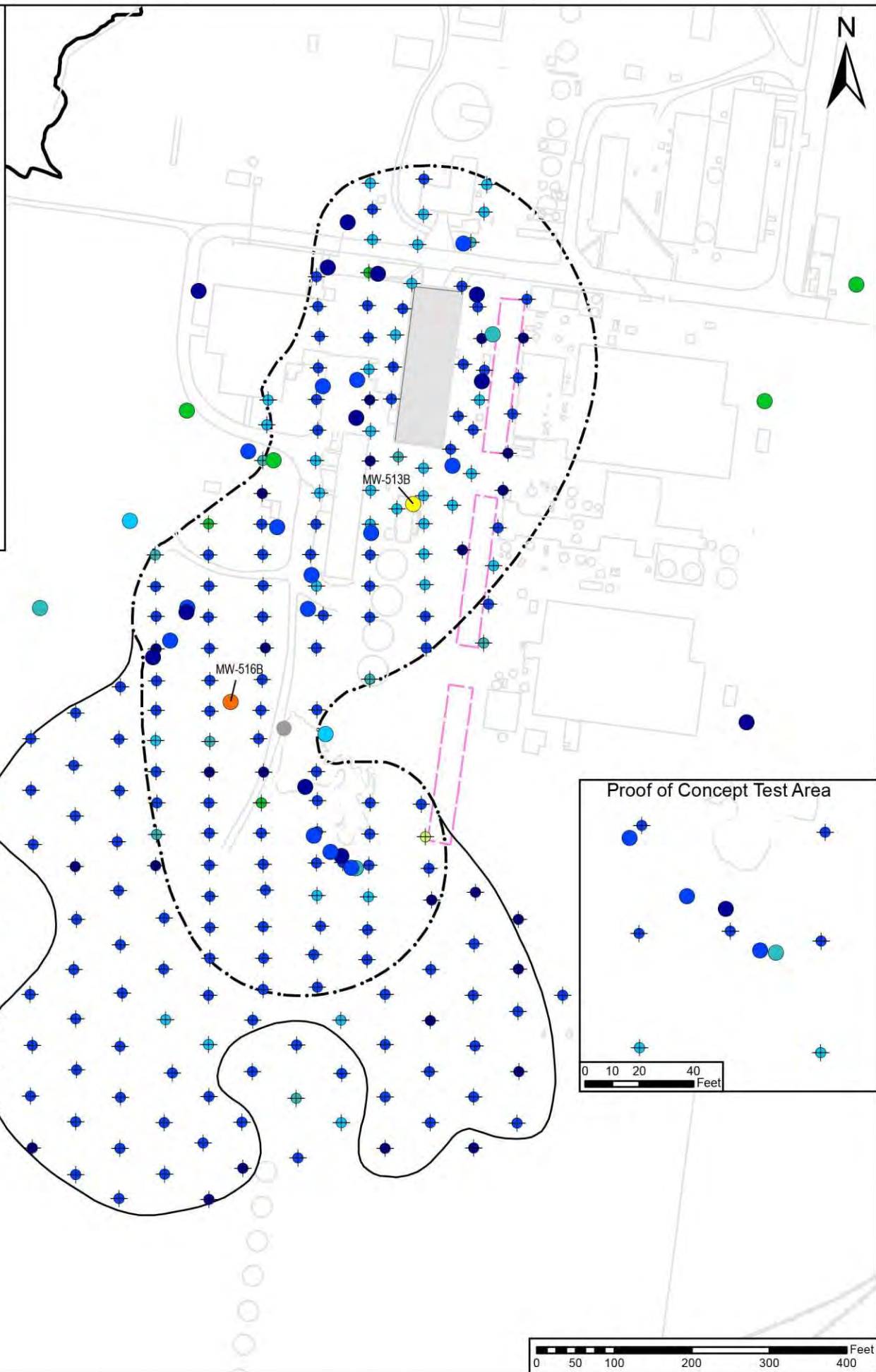

Figure 4-27: Post-sparge (Phase 3) pH in deep Satilla monitoring, extraction and sparge wells
 LCP Chemicals Site, Brunswick, GA

Legend

Post-Phase 3 Geoprob

pH

- ▲ < 6.5
- ▲ 6.5 - 7.0
- ▲ 7.0 - 8.0
- ▲ 8.0 - 9.0
- ▲ 9.0 - 10.0
- ▲ 10.0 - 10.5
- ▲ 10.5 - 11.0
- ▲ 11.0 - 11.5
- ▲ 11.5 - 12.0
- ▲ > 12.0

Phase 2 Geoprob

- ▲ Post-Sparge
- ▲ Pre-Sparge

- ⊕ Sparge Wells
- 33 ft ROI
- Phase 1 Footprint
- Phase 2 Footprint
- Historical Structures
- Marsh Boundary
- ▭ Infiltration Gallery
- ▭ Elevated Pad

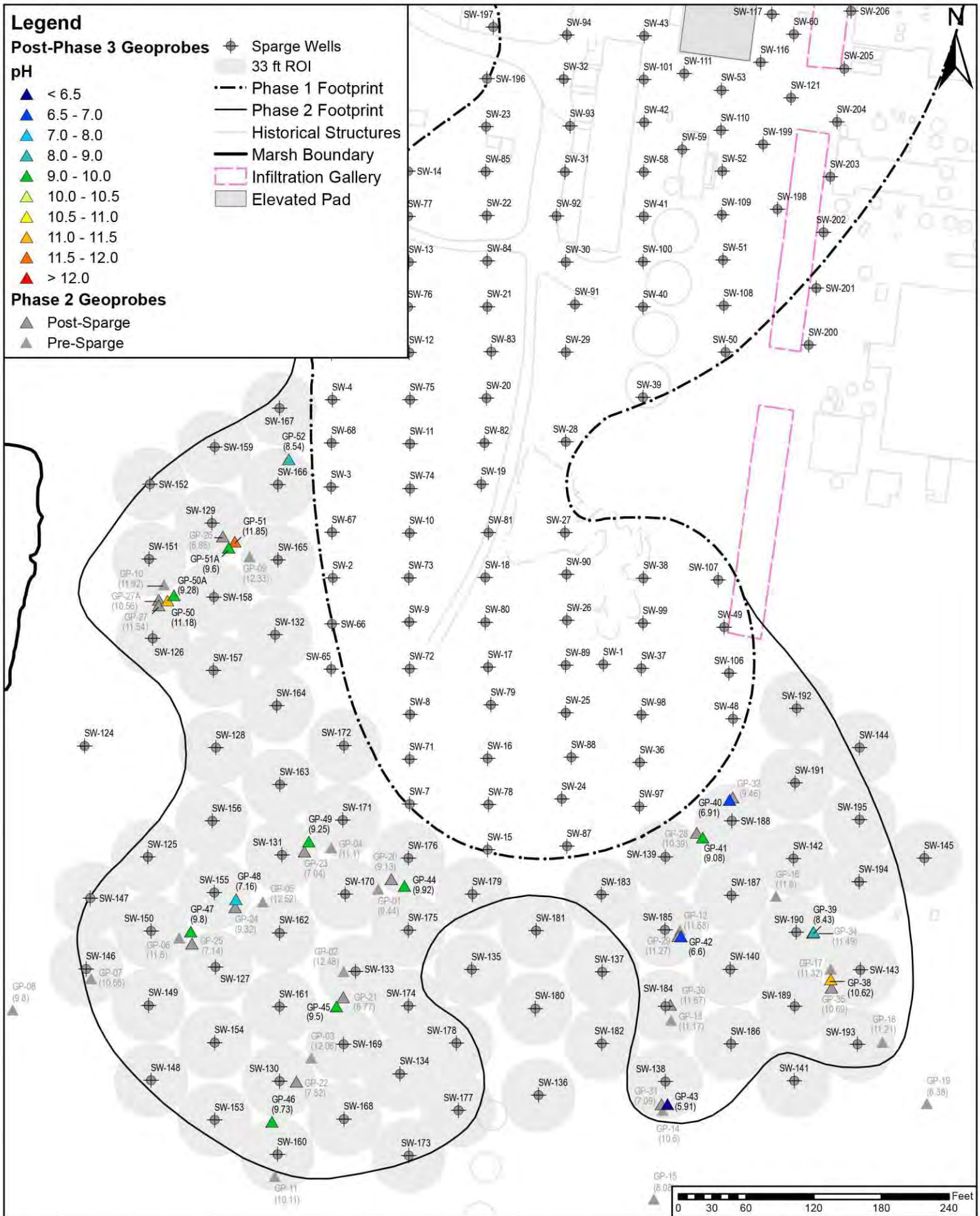

Figure 4-28: Post-sparge (Phase 3) pH in southern Geoprobe locations
LCP Chemicals Site, Brunswick, GA

Legend

- · - Phase 1 Footprint
- Phase 2 Footprint
- Historical Structures
- Marsh Boundary
- ▭ Infiltration Gallery
- ▭ Elevated Pad

post3_pH

- <6.5
- 6.5-7.0
- 7.0-8.0
- 8.0-9.0
- 9.0-10.0
- 10.0-10.5
- 10.5-11.0
- 11.0-11.5
- 11.5-12.0
- >12

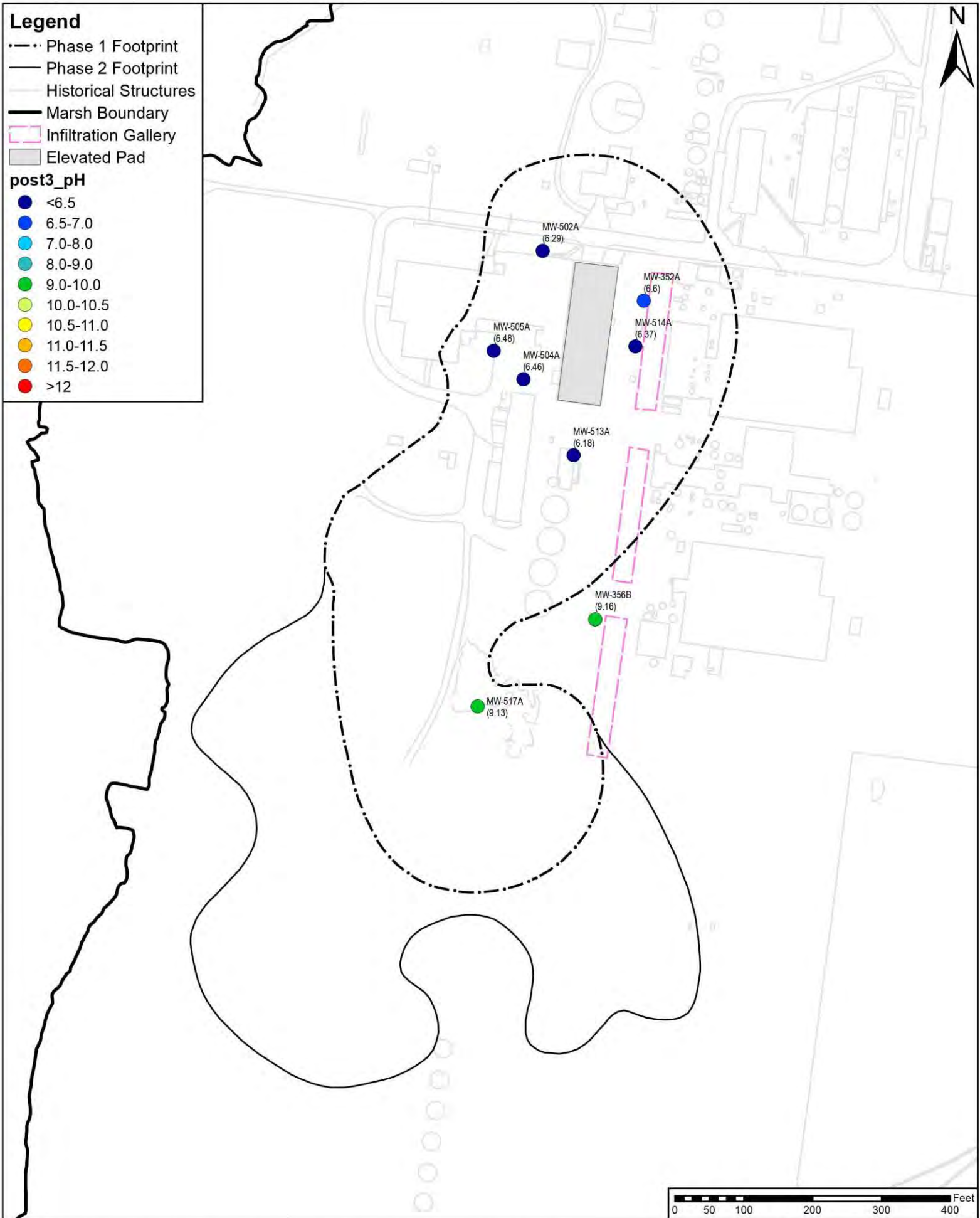

Figure 4-29: Post-sparging (Phase 3) pH in mid Satilla monitoring wells
LCP Chemicals Site, Brunswick, GA

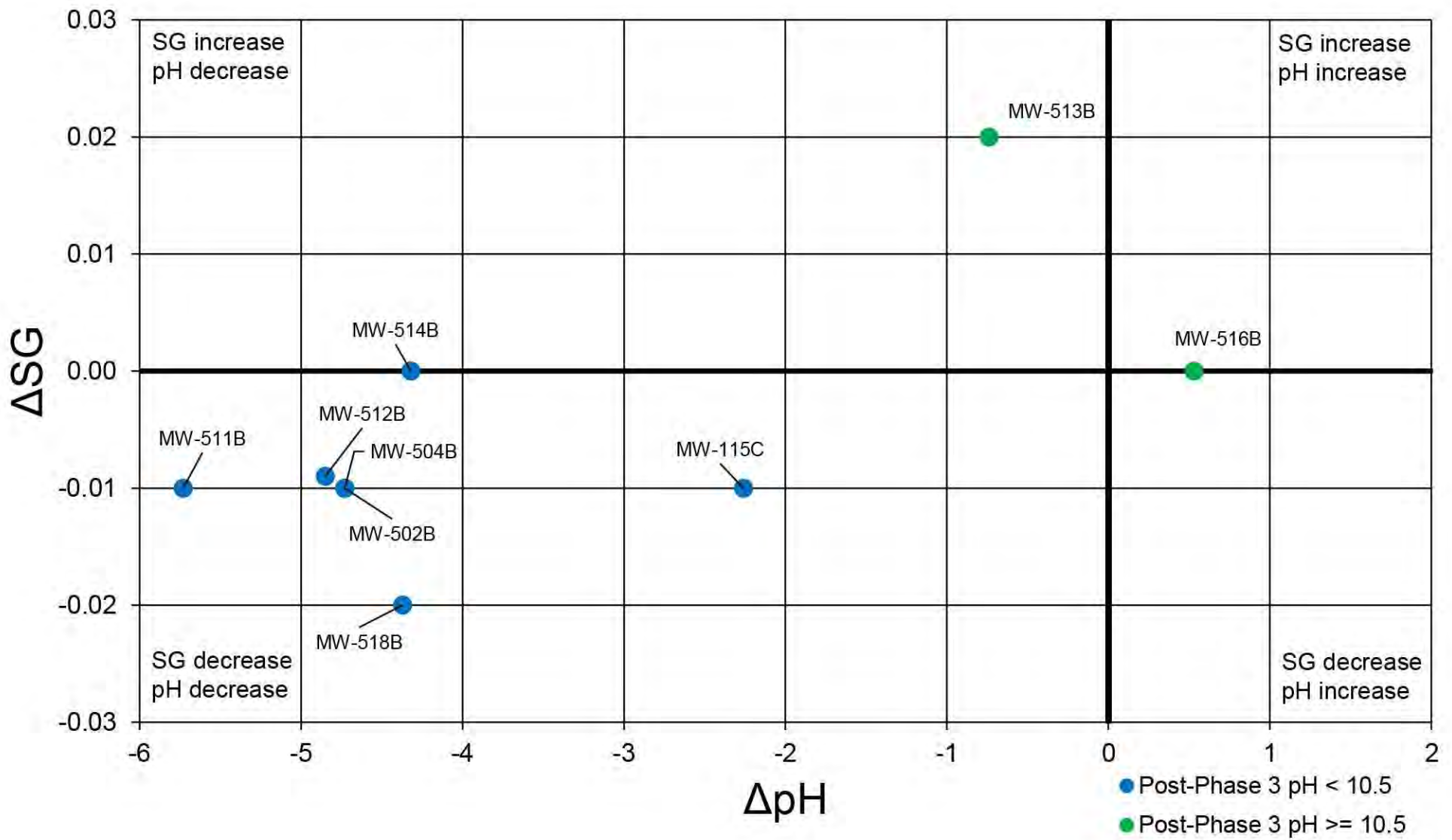
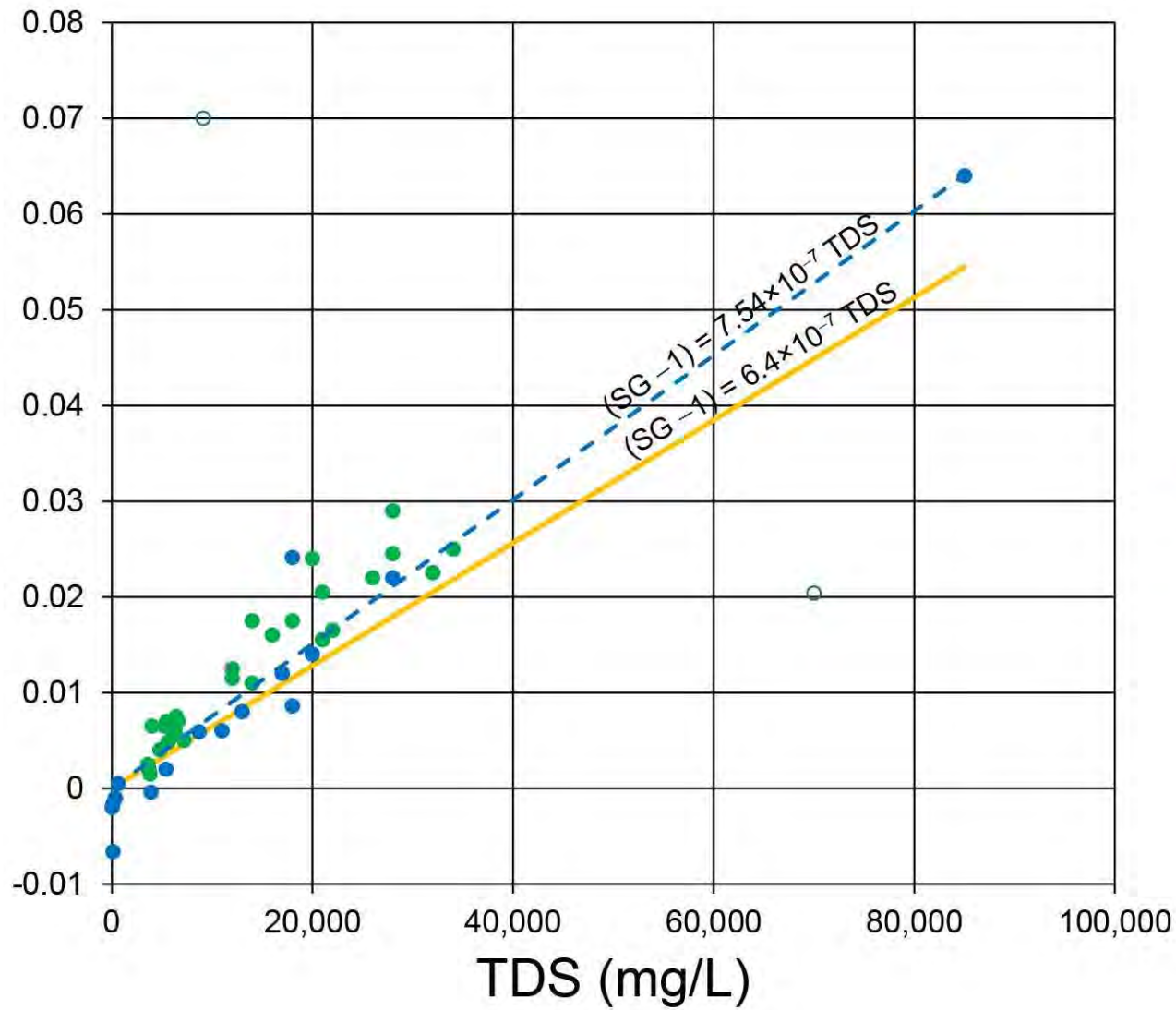

Figure 4-30: Changes in deep Satilla specific gravity due to sparging
 LCP Chemicals Site, Brunswick, GA

SG - 1.0



- R.I. data (1995-1996)
- R.I. data (1995-1996) - outliers
- Phase 3 (2015-2016)
- Regression (Kohfahl et al, 2015) ———
- Regression R.I. Data - - - -

Figure 4-31: Relationship between specific gravity and TDS for deep Satilla groundwater
LCP Chemicals Site, Brunswick, GA

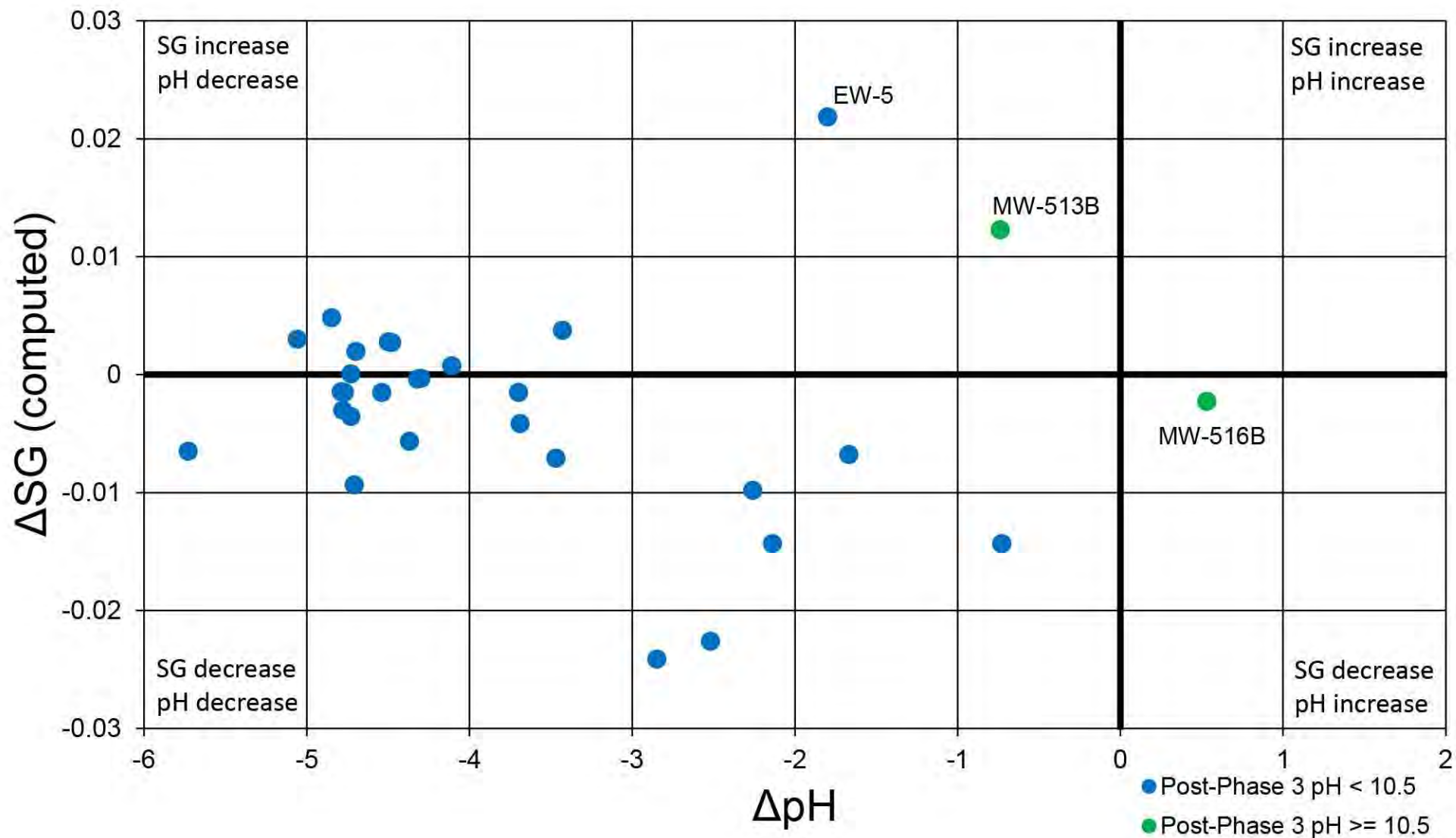

Figure 4-32: Changes in deep Satilla computed specific gravity due to sparging
 LCP Chemicals Site, Brunswick, GA

Legend

- · - Phase 1 Footprint
- Phase 2 Footprint
- Historical Structures
- Marsh Boundary
- Infiltration Gallery
- Elevated Pad

Total Mercury (µg/L)

- <2
- 2 - 20
- 20 - 50
- 50 - 200
- >200

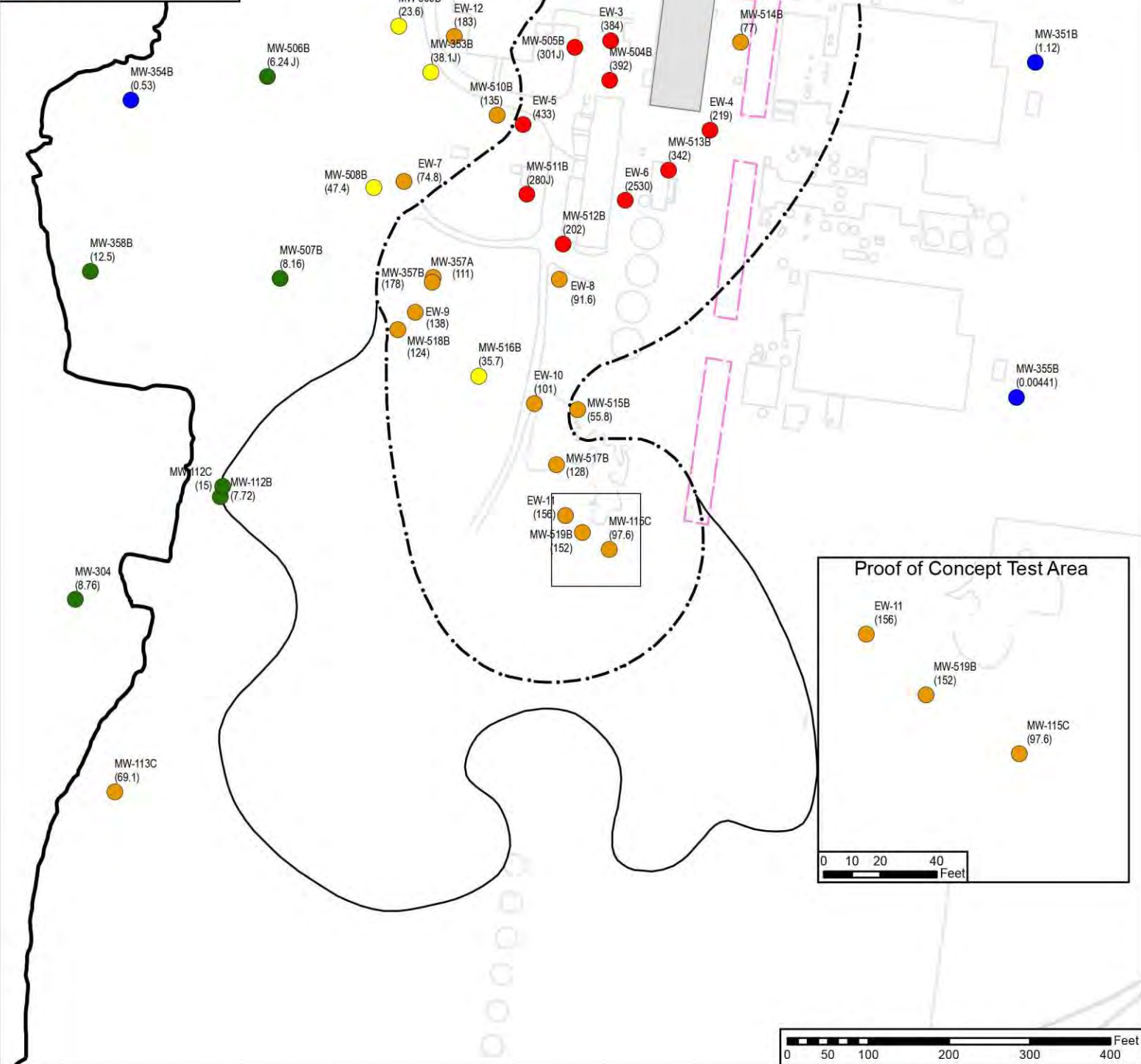

Figure 4-33: Pre-sparg (2011-2012) total mercury in deep Satilla monitoring and extraction wells
LCP Chemicals Site, Brunswick, GA

Legend

- · - Phase 1 Footprint
- Phase 2 Footprint
- Historical Structures
- Marsh Boundary
- Infiltration Gallery
- Elevated Pad

Total Mercury (µg/L)

- <2
- 2 - 20
- 20 - 50
- 50 - 200
- <200
- Not Available

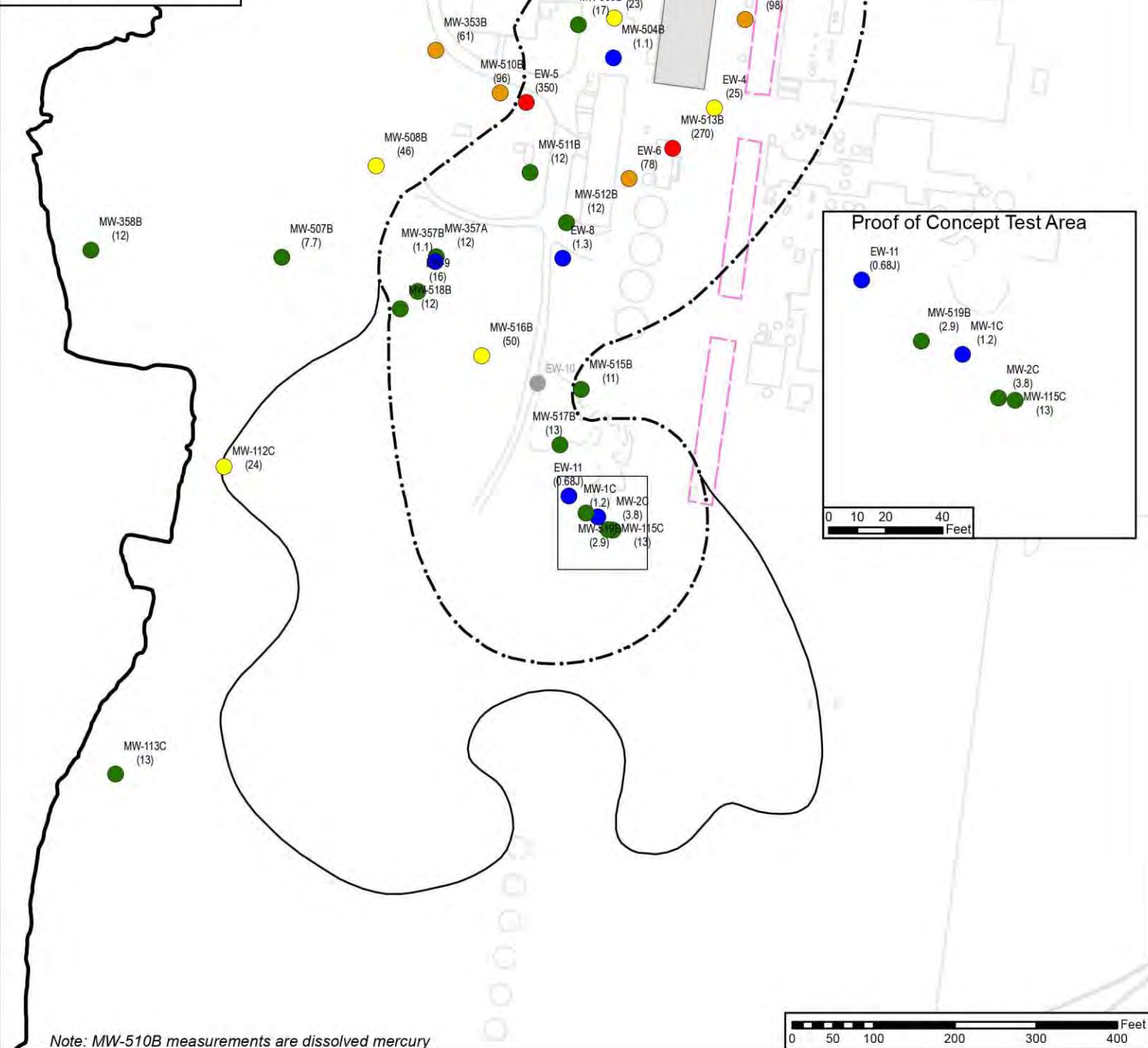

Note: MW-510B measurements are dissolved mercury

Figure 4-34: Pre-sparg (Phase 3) total mercury in deep Satilla monitoring and extraction wells
LCP Chemicals Site, Brunswick, GA

Legend

- · - Phase 1 Footprint
- Phase 2 Footprint
- Historical Structures
- Marsh Boundary
- Infiltration Gallery
- Elevated Pad

Dissolved Mercury ($\mu\text{g/L}$)

- <2
- 2 - 20
- 20 - 50
- 50 - 200
- >200

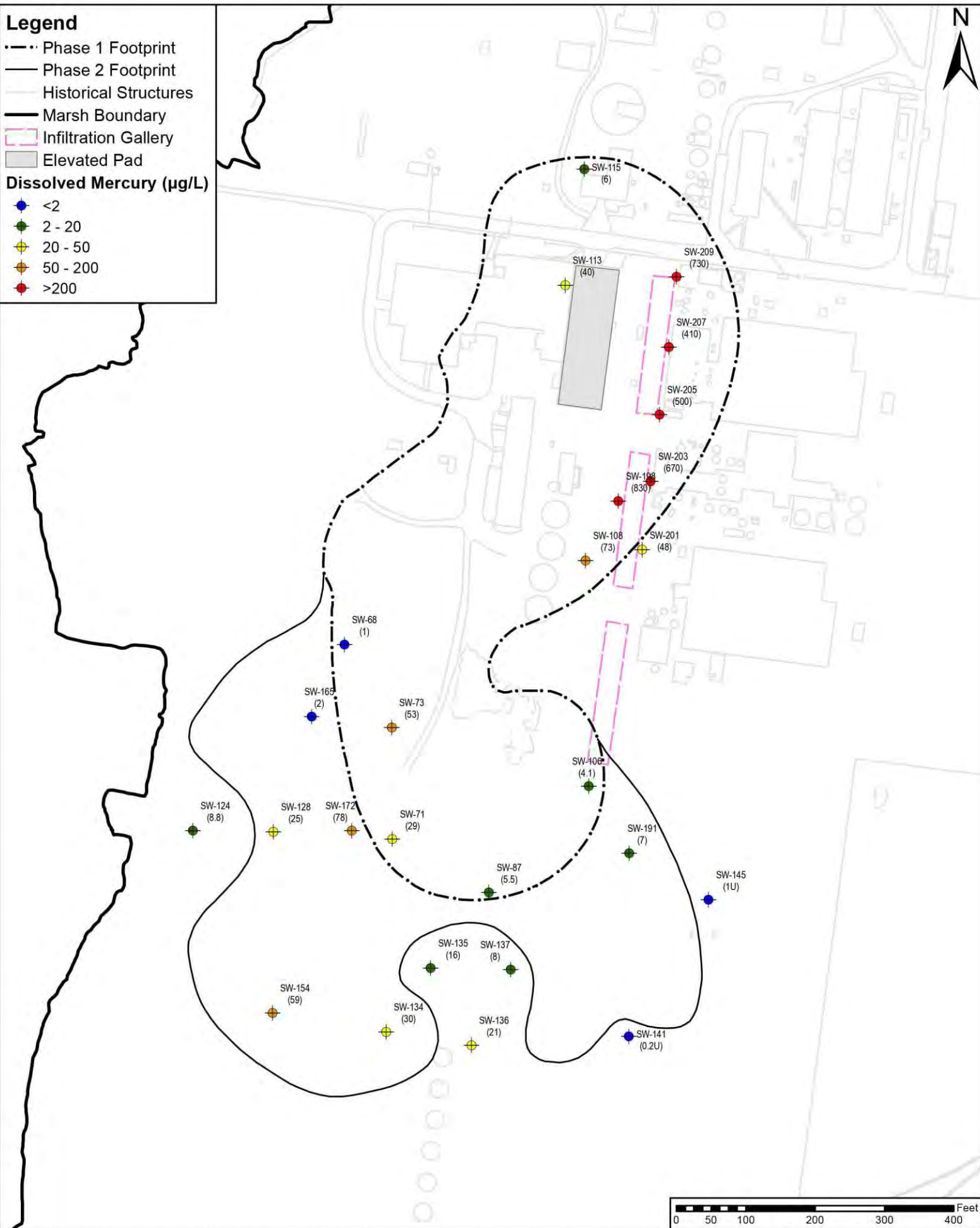

Figure 4-35: Pre-sparge (Phase 3) dissolved mercury in Phase 2 and Phase 3 sparge wells
 LCP Chemicals Site, Brunswick, GA

Legend

- · - Phase 1 Footprint
- Phase 2 Footprint
- Historical Structures
- Marsh Boundary
- Infiltration Gallery
- Elevated Pad

Total Mercury (µg/L)

- <2
- 2 - 20
- 20 - 50
- 50 - 200
- >200

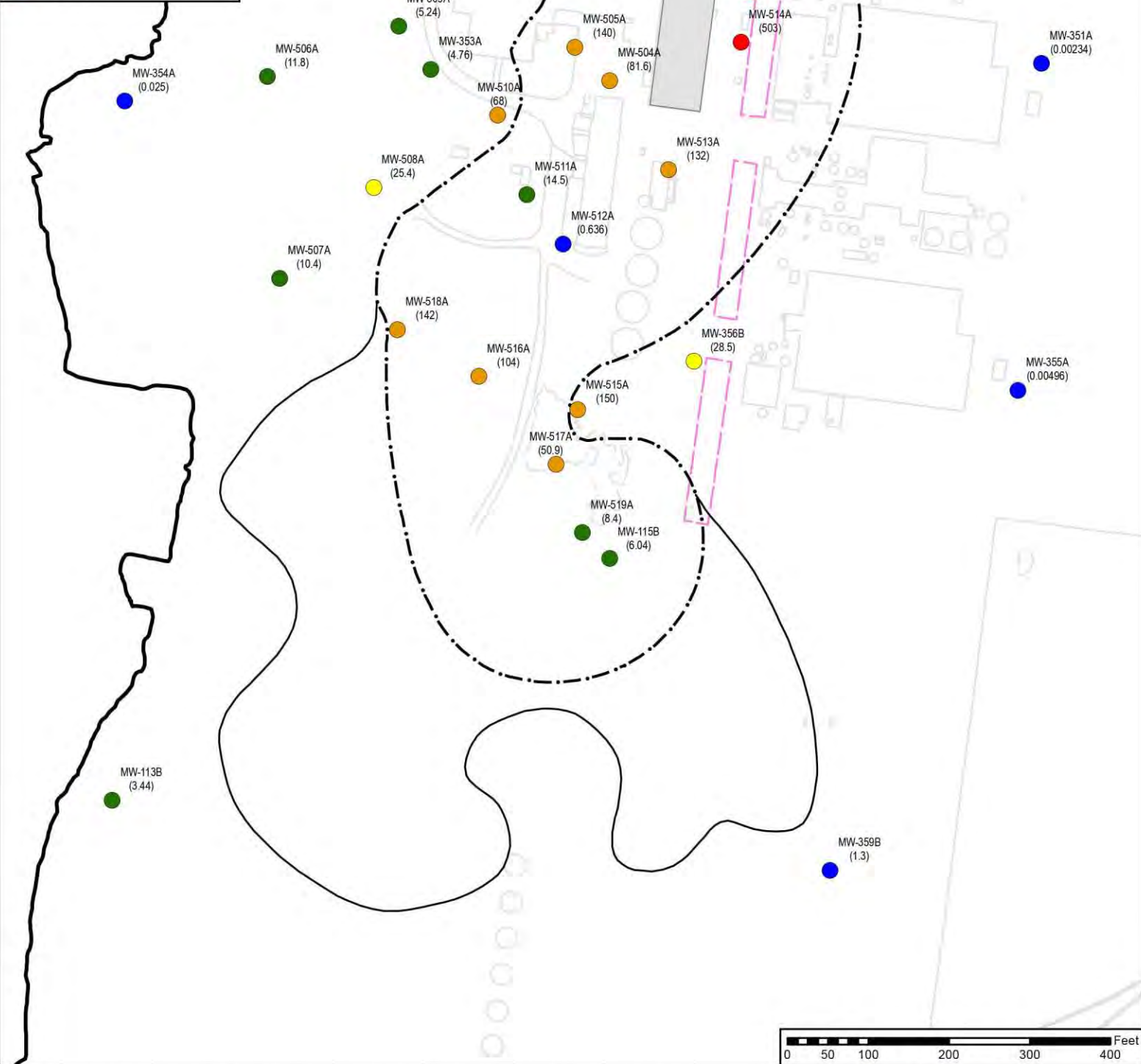

Figure 4-36: Pre-sparge (2012) total mercury in mid Satilla monitoring wells
LCP Chemicals Site, Brunswick, GA

Legend

- · - Phase 1 Footprint
- Phase 2 Footprint
- Historical Structures
- Marsh Boundary
- Infiltration Gallery
- Elevated Pad

Total Mercury (µg/L)

- <2
- 2 - 20
- 20 - 50
- 50 - 200
- >200
- Not Available

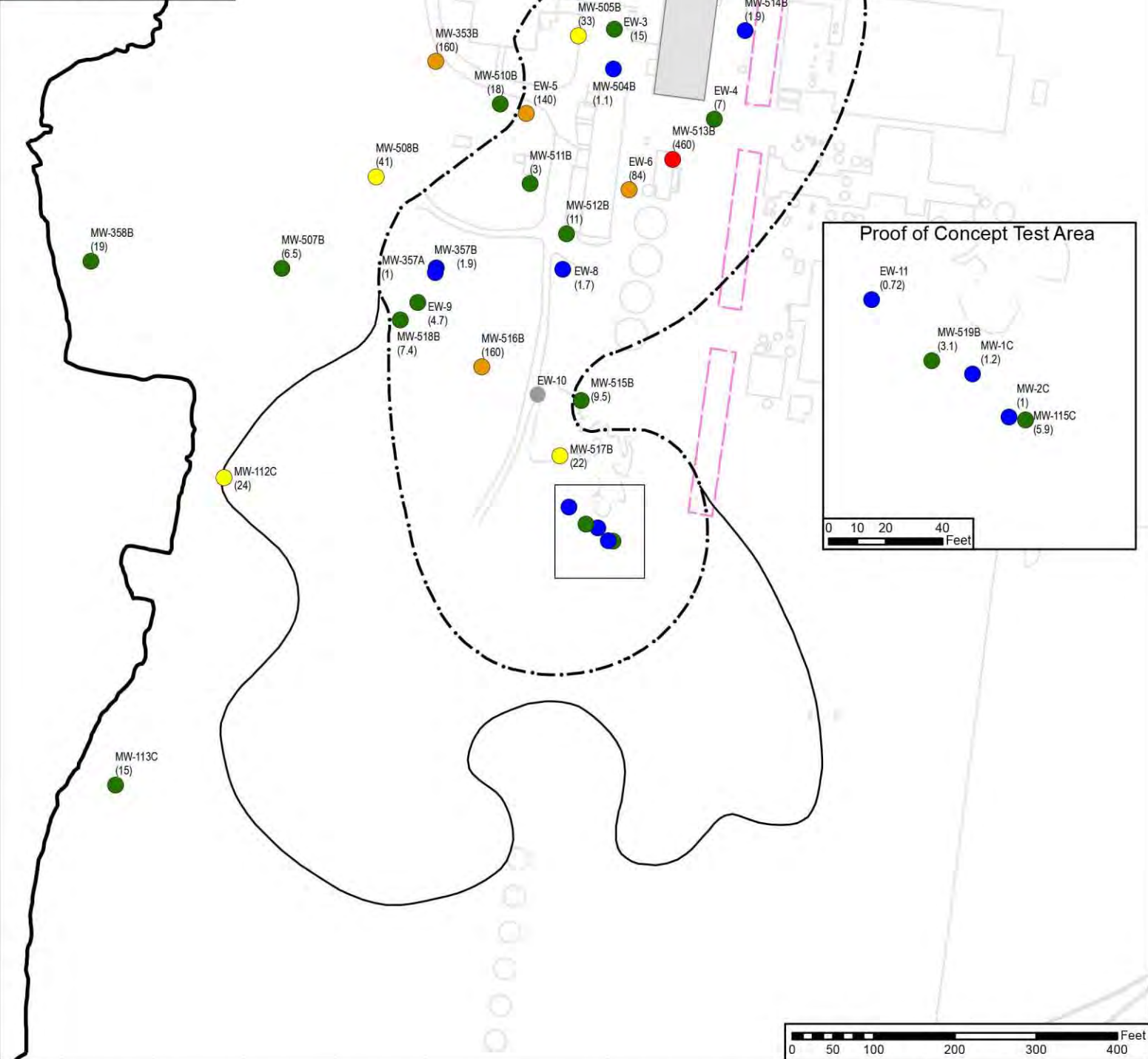
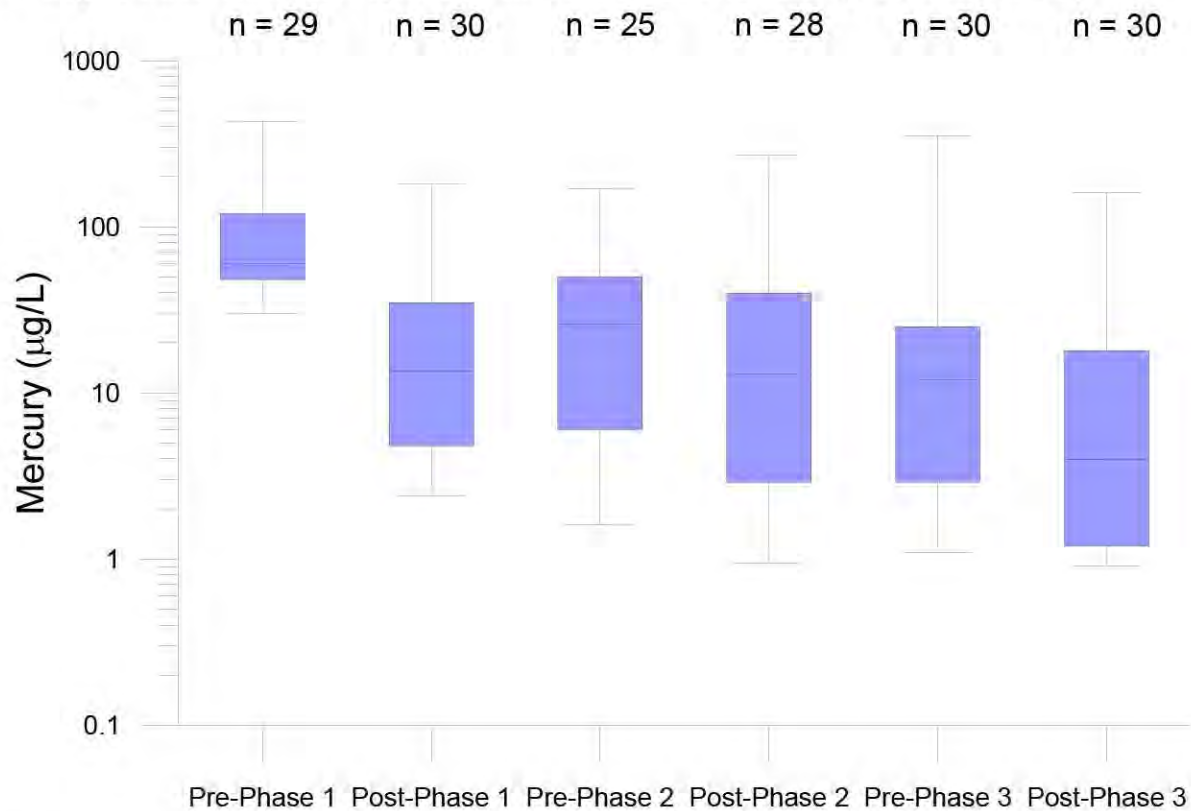

Figure 4-37: Post-sparge (Phase 3) total mercury in deep Satilla monitoring and extraction wells
LCP Chemicals Site, Brunswick, GA

Deep Satilla monitoring wells and extraction wells (northern area)



Geoprobe locations (southern area)

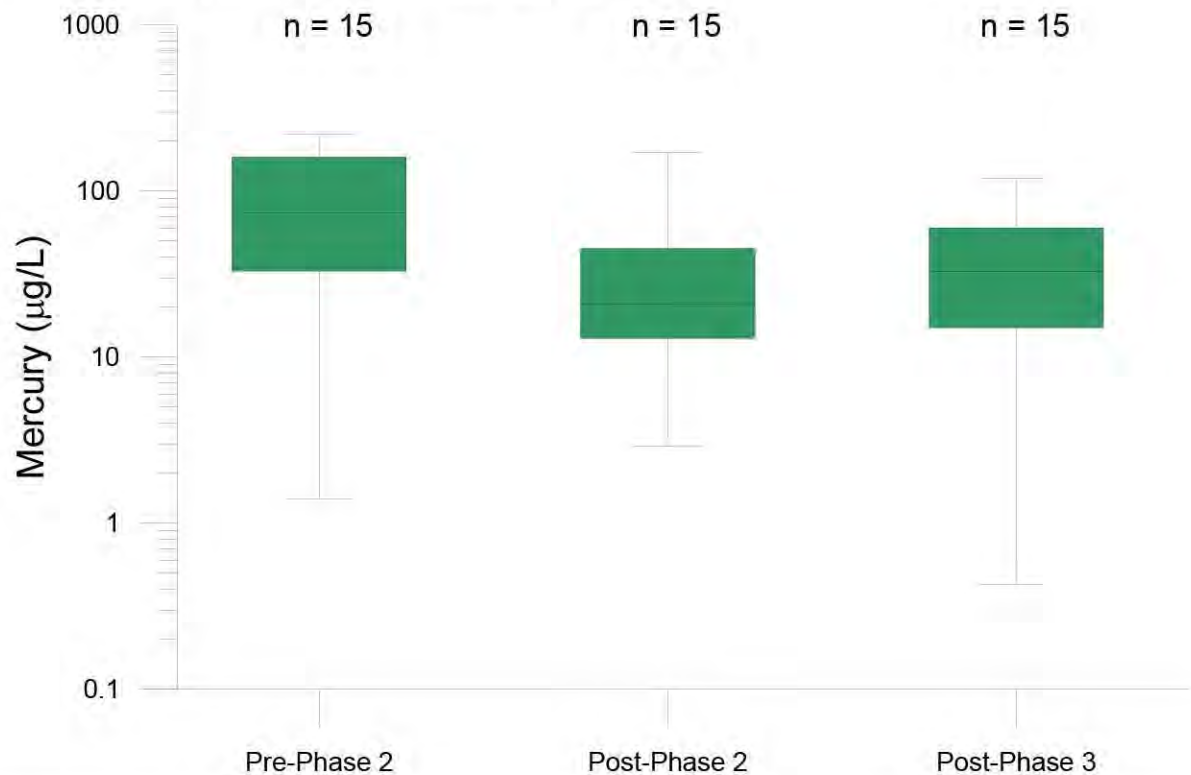

Figure 4-38: Box plot of mercury concentrations in deep Satilla monitoring locations

LCP Chemicals Site, Brunswick, GA

Legend

- Phase 1 Footprint
- Phase 2 Footprint
- Historical Structures
- Marsh Boundary
- Infiltration Gallery
- Elevated Pad

Dissolved Mercury ($\mu\text{g/L}$)

- <2
- 2 - 20
- 20 - 50
- 50 - 200
- >200

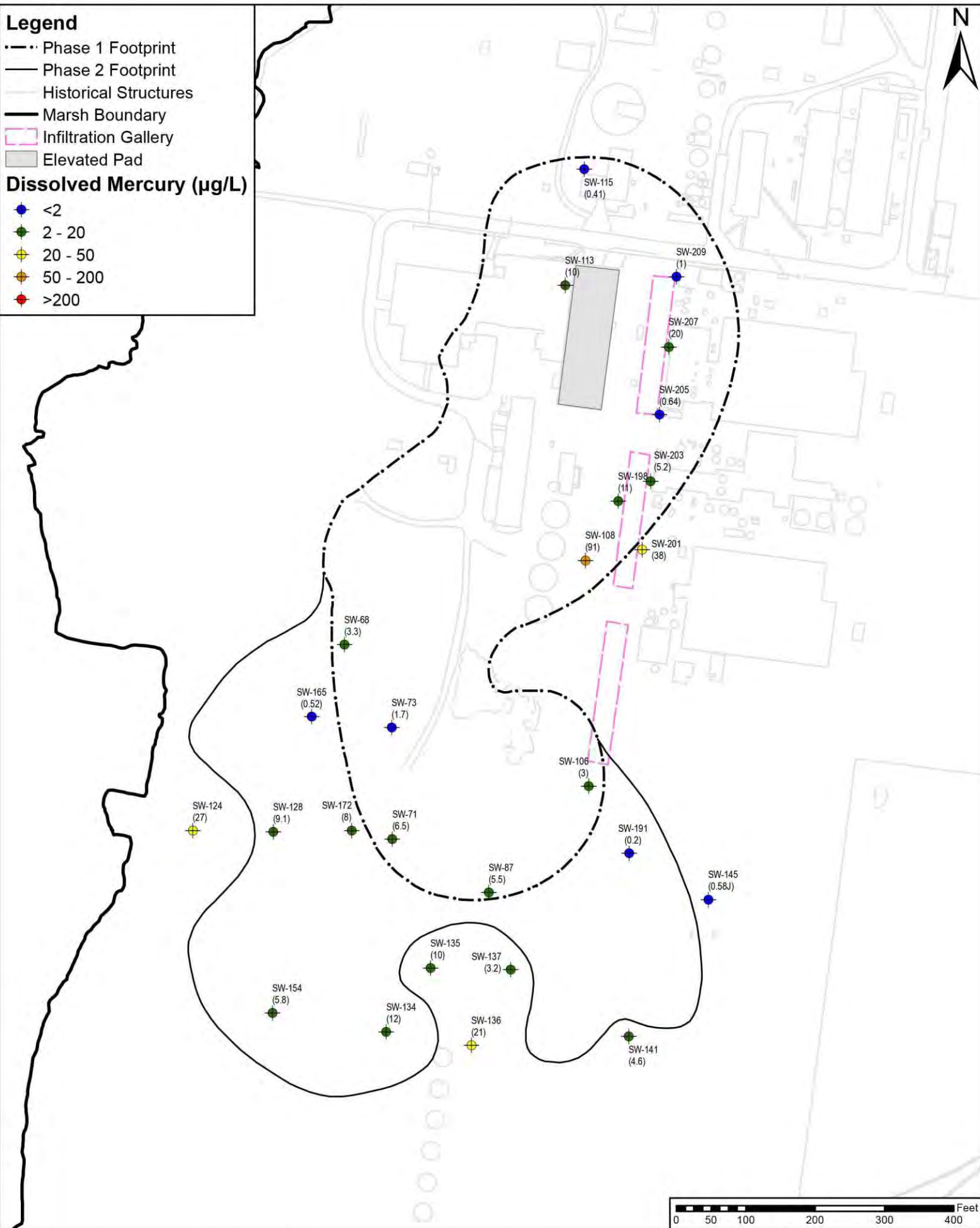

Figure 4-39: Post-spargage (Phase 3) dissolved mercury in sparge wells
LCP Chemicals Site, Brunswick, GA

Legend

- · - Phase 1 Footprint
- Phase 2 Footprint
- Historical Structures
- Marsh Boundary
- Infiltration Gallery
- Elevated Pad

Mercury (µg/L)

- <2
- 2 - 20
- 20 - 50
- 50 - 200
- >200
- Not Available

○ Monitoring point

⊕ Sparge well

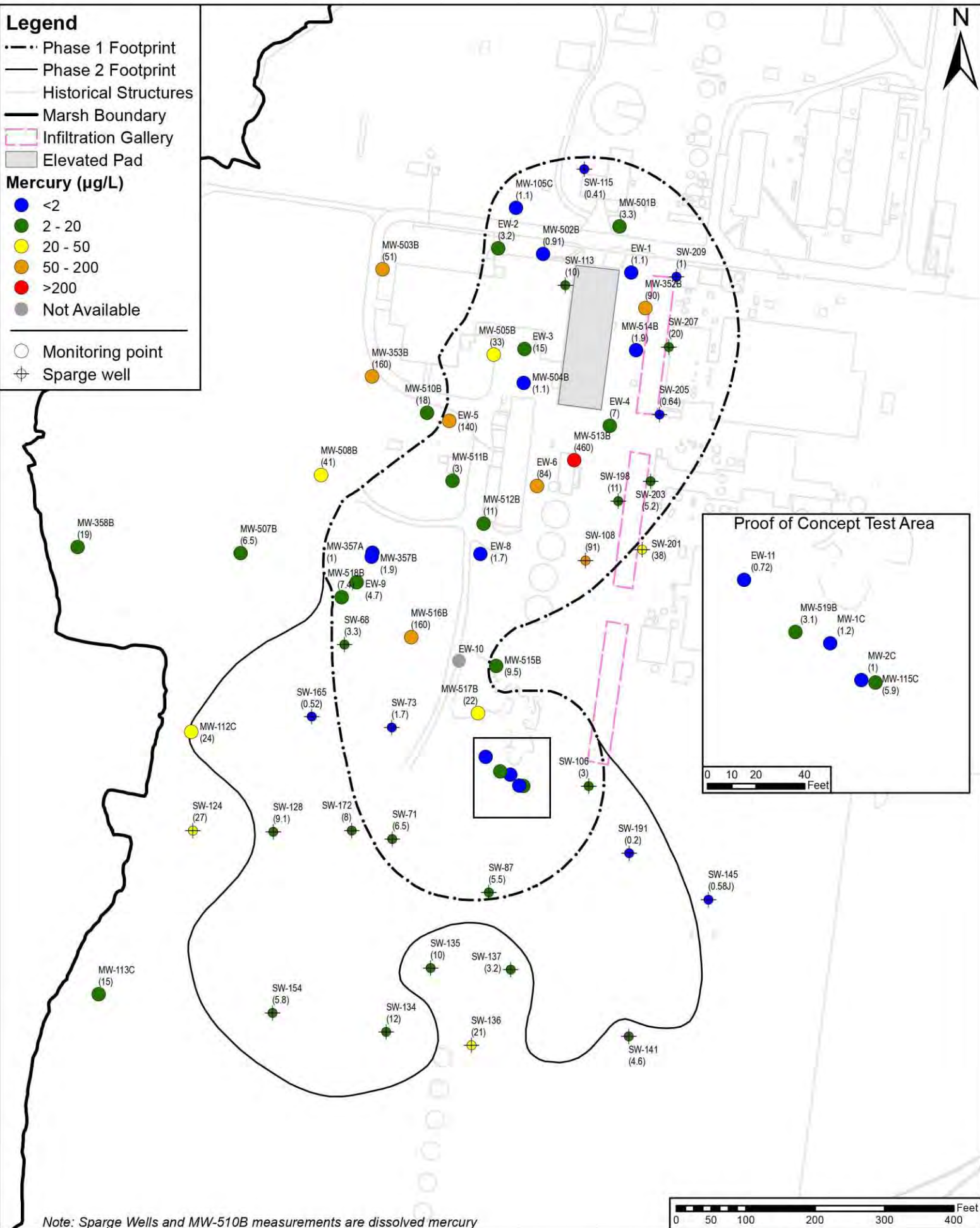

Note: Sparge Wells and MW-510B measurements are dissolved mercury

Figure 4-40: Post-sparge (Phase 3) total and dissolved mercury in deep Satilla monitoring, extraction and sparge wells
LCP Chemicals Site, Brunswick, GA

Legend

- Post-Phase 3 Geoprob**
- Total Mercury ($\mu\text{g/L}$)**
 - ▲ <2
 - ▲ 2 - 20
 - ▲ 20 - 50
 - ▲ 50 - 200
 - ▲ >200
- Phase 2 Geoprob**
 - ▲ Post-Sparge
 - ▲ Pre-Sparge
- Sparge Wells
- 33 ft ROI
- Phase 1 Footprint
- Phase 2 Footprint
- Historical Structures
- Marsh Boundary
- Infiltration Gallery
- Elevated Pad

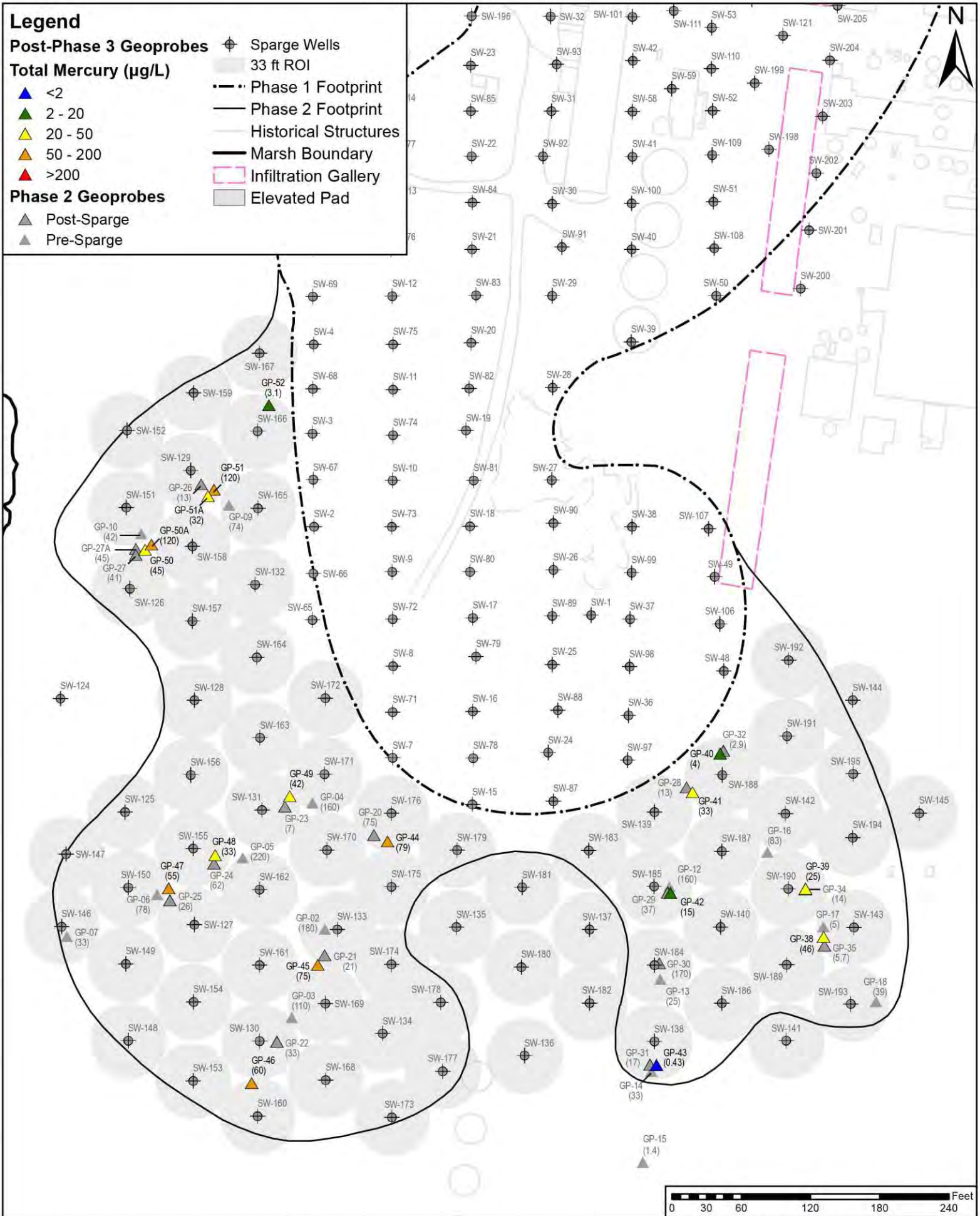

Figure 4-41: Post-sparge (Phase 3) dissolved mercury in southern Geoprobe locations
LCP Chemicals Site, Brunswick, GA

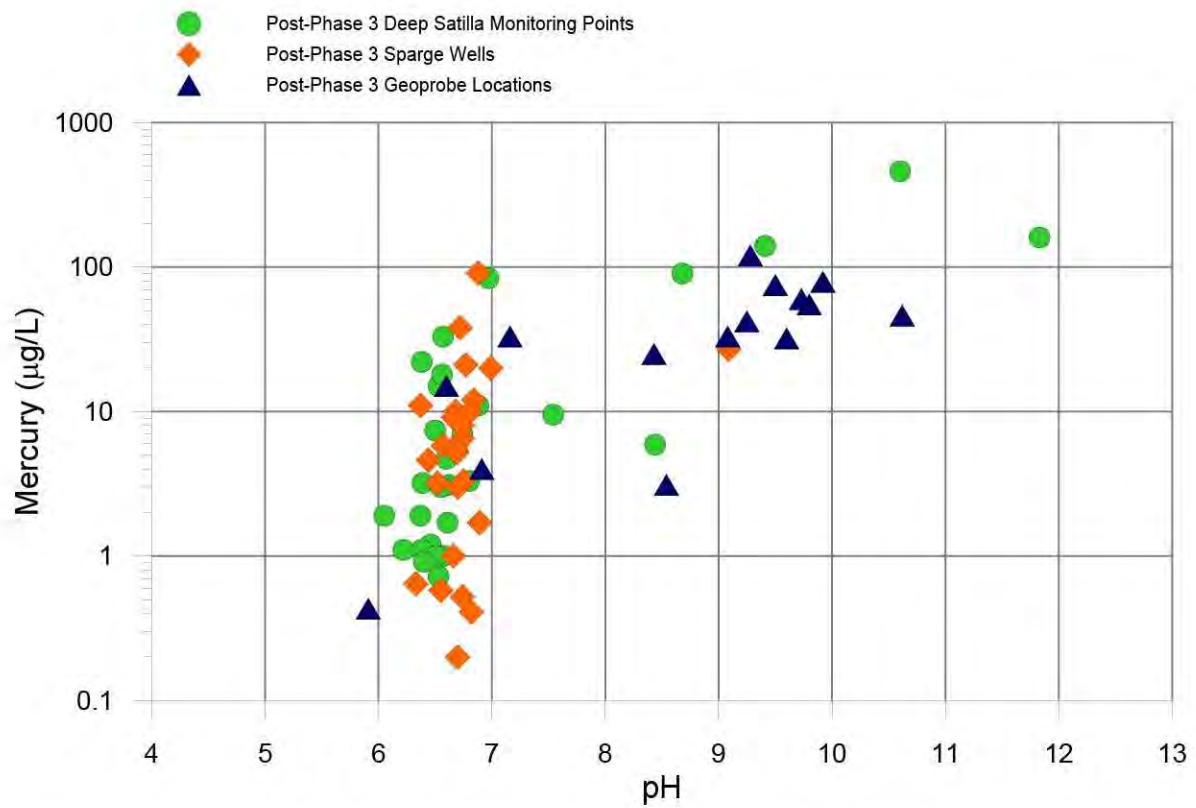
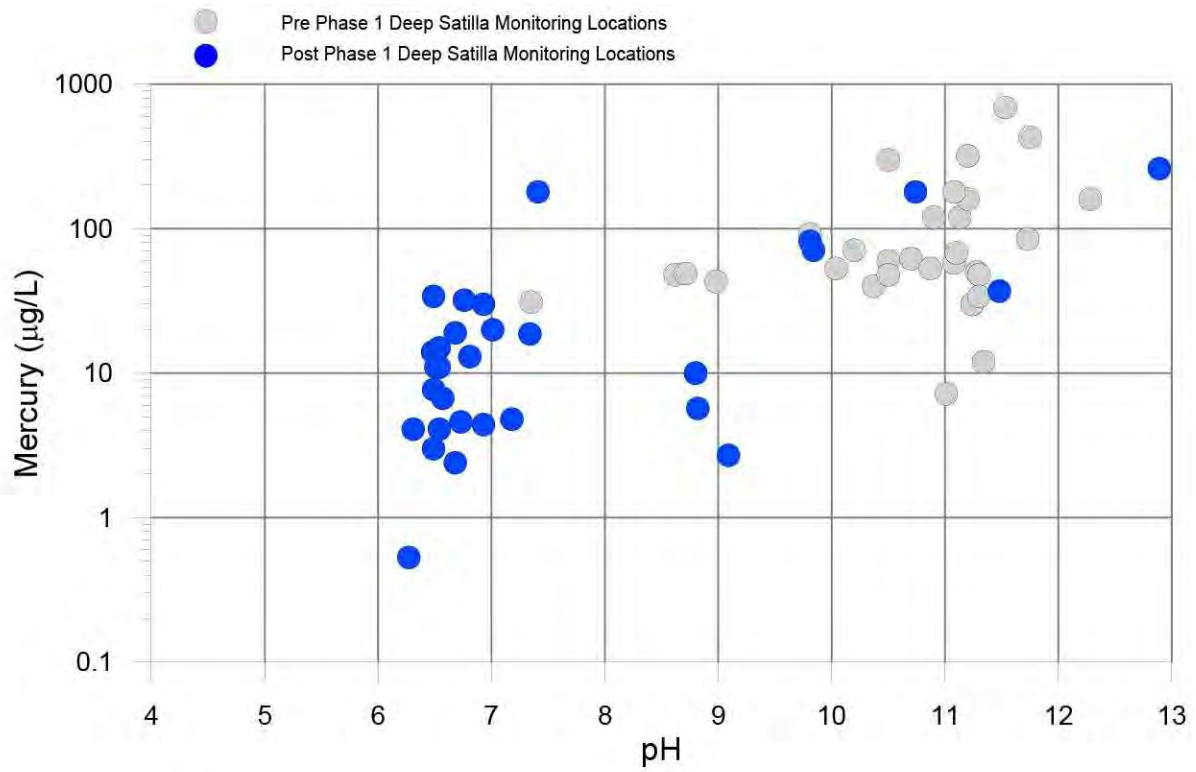

Figure 4-42: Relationship between Hg and pH in deep Satilla monitoring locations
 LCP Chemicals Site, Brunswick, GA

Legend

- · - Phase 1 Footprint
- Phase 2 Footprint
- Historical Structures
- Marsh Boundary
- Infiltration Gallery
- Elevated Pad

Total Mercury (µg/L)

- <2
- 2 - 20
- 20 - 50
- 50 - 200
- >200

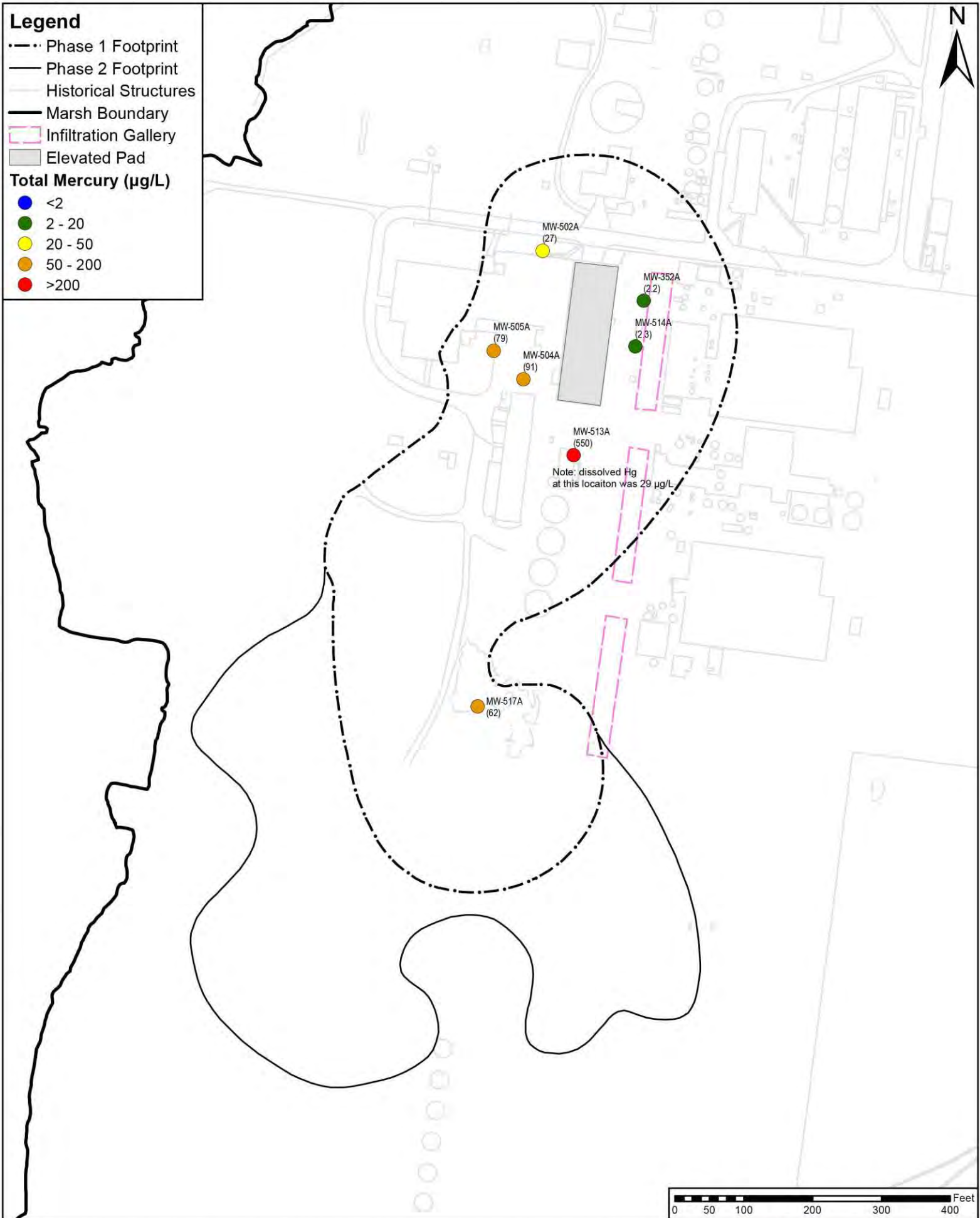

Figure 4-43: Post-sparge (Phase 3) total mercury in mid Satilla monitoring wells
LCP Chemicals Site, Brunswick, GA

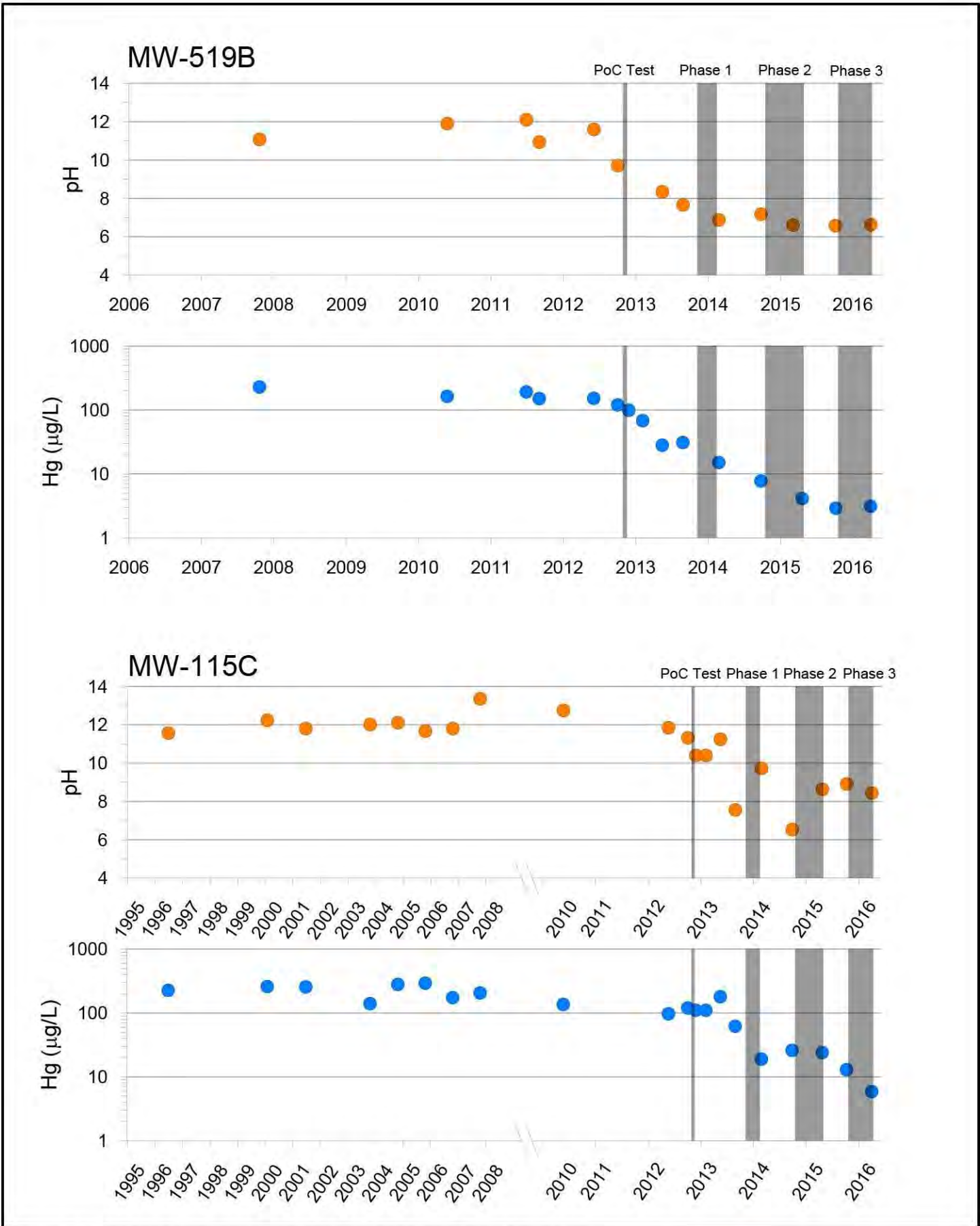

Figure 4-44: Historical pH and Hg in MW-519B and MW-115C

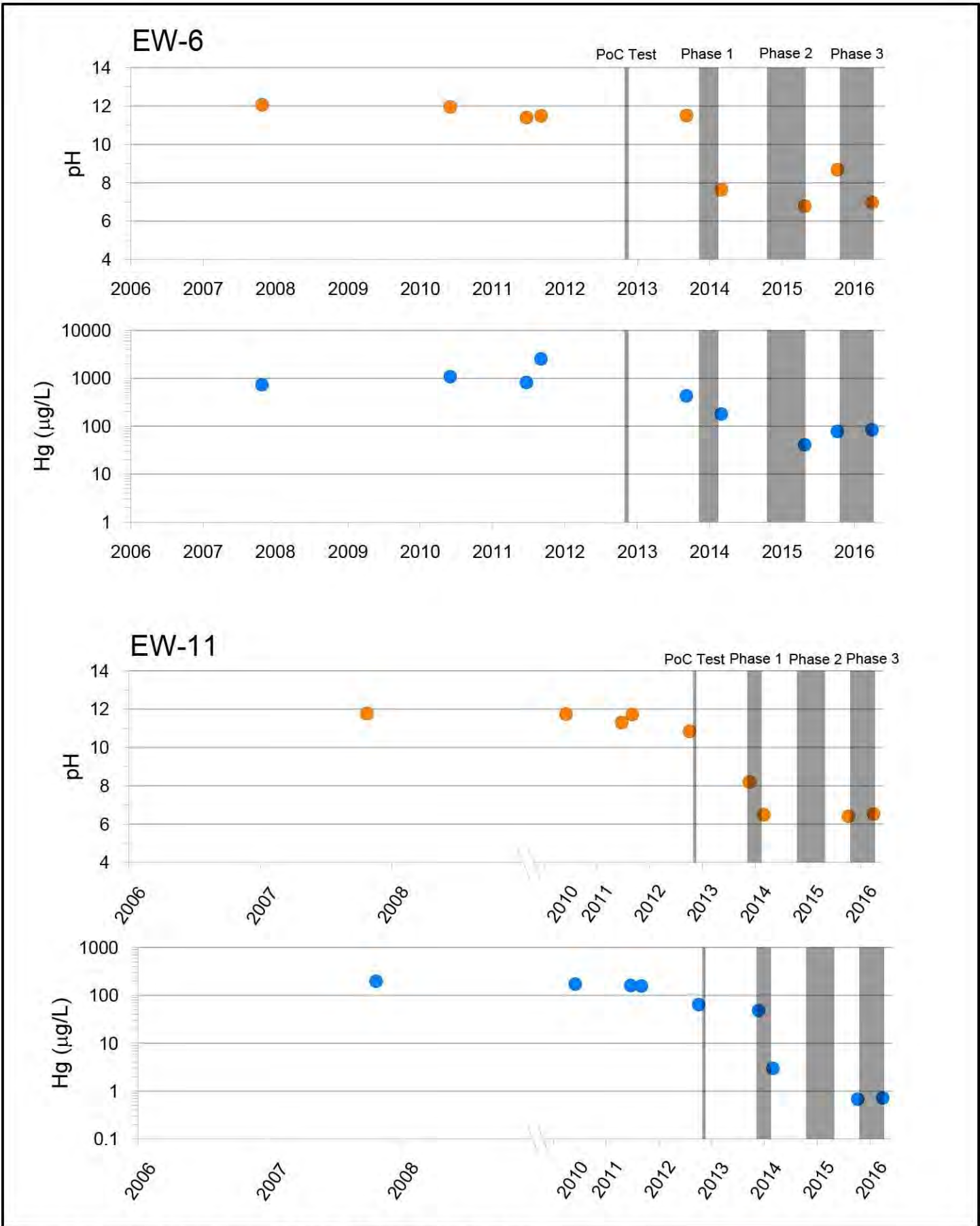

Figure 4-45: Historical pH and Hg in EW-6 and EW-11

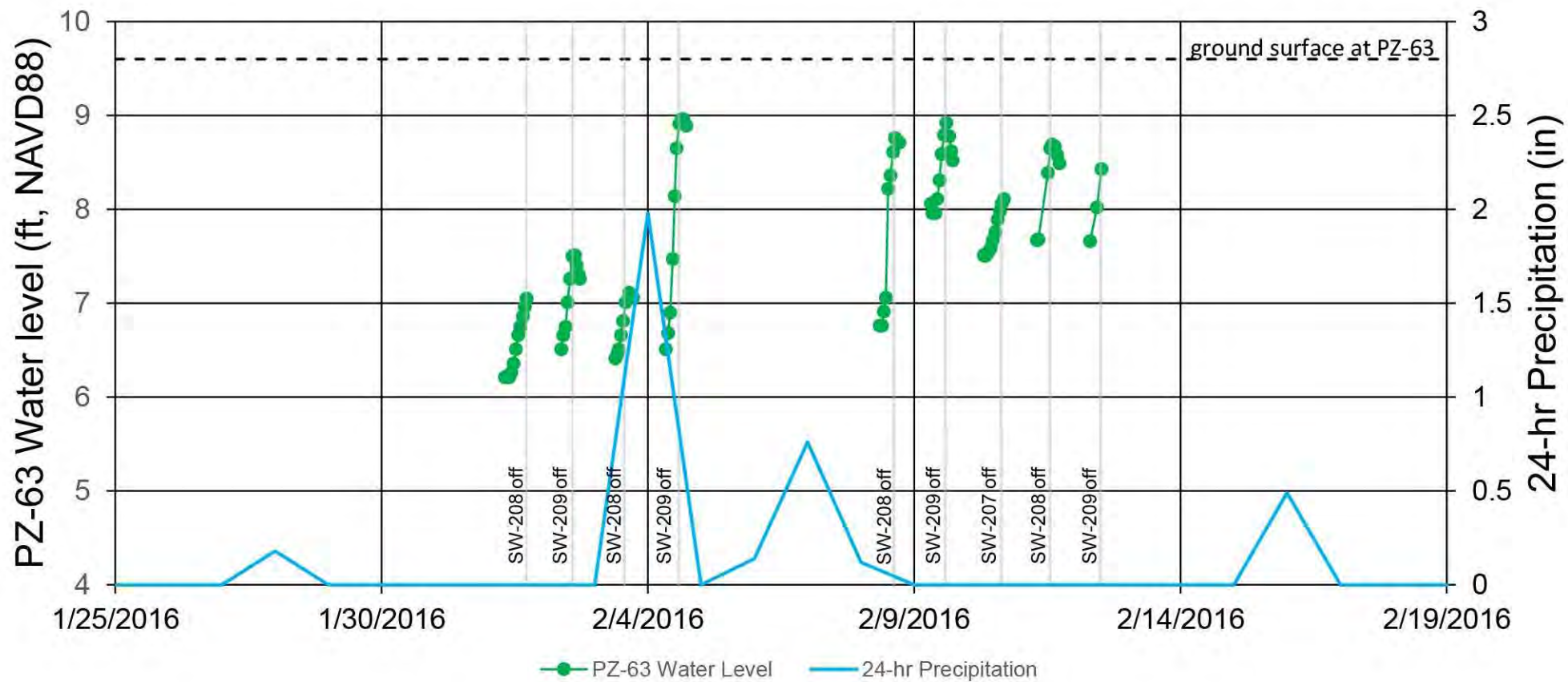

Figure 4-46: PZ-63 hydrograph and daily precipitation data (precipitation data from "NOAA CDO" Brunswick, GA)
 LCP Chemicals Site, Brunswick, GA

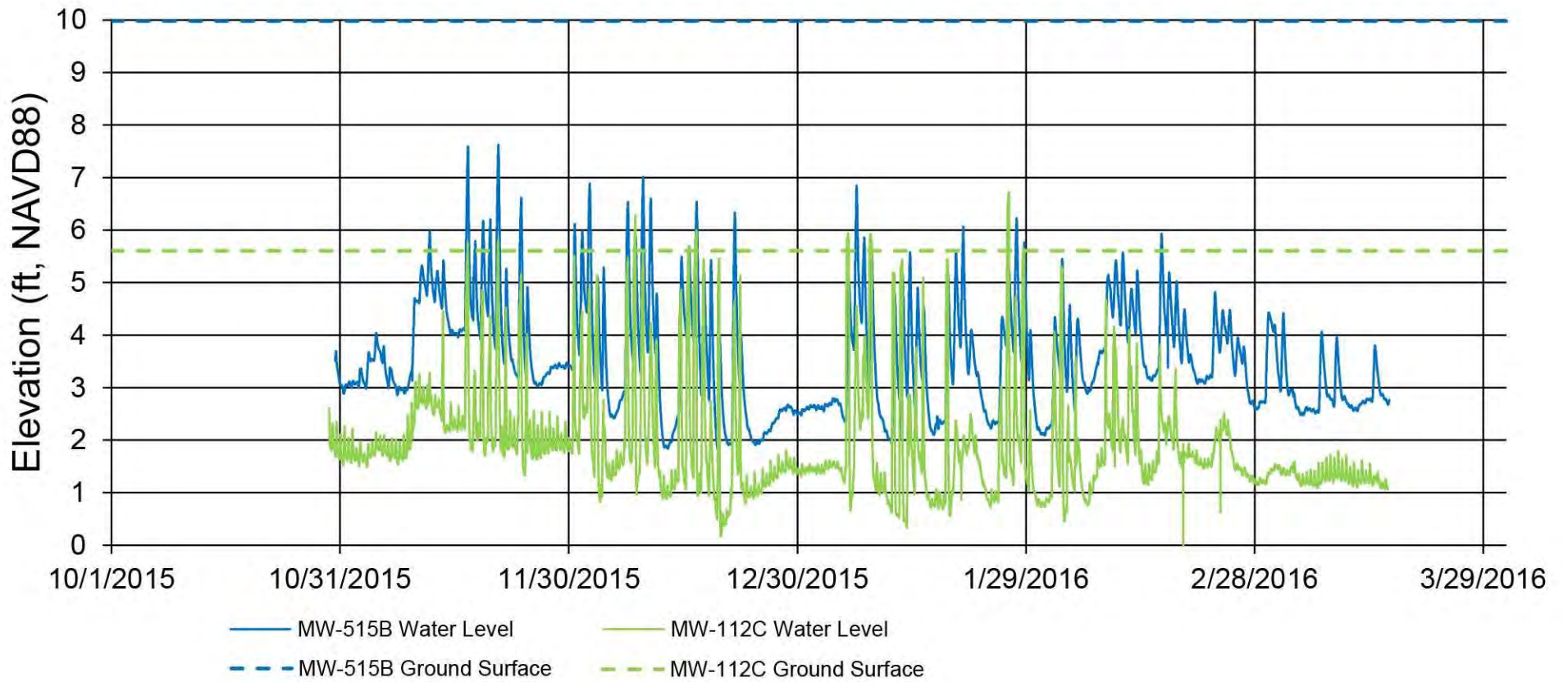
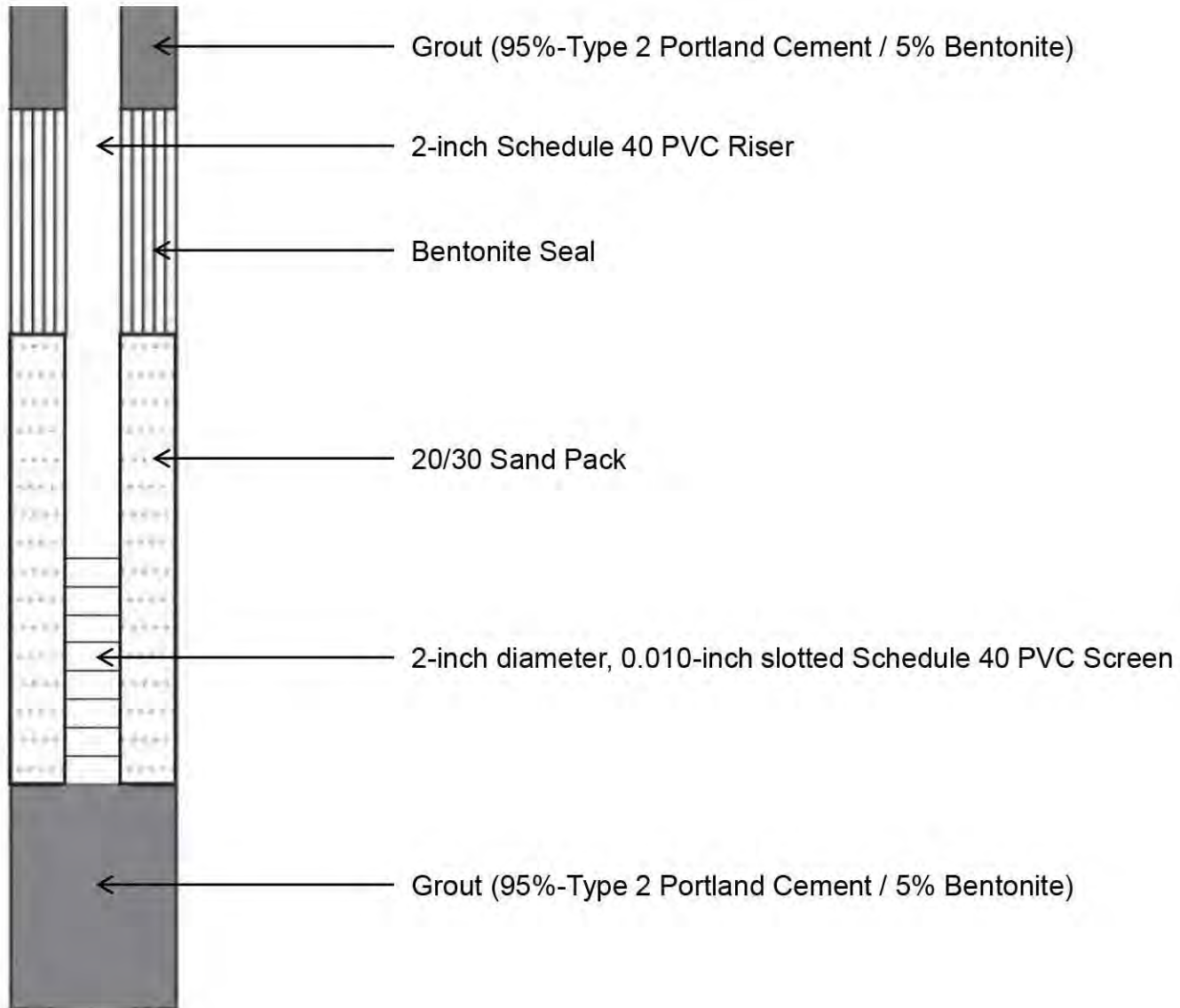

Figure 4-47: MW-515B and MW-112C hydrographs
 LCP Chemicals Site, Brunswick, GA

Appendix A:

Boring Logs/Well Construction Diagrams

Well Construction Diagram Legend



Phase 1 Sparge Well Boring Logs

BORING LOG



Site Name: LCP Chemicals Site, Brunswick GA
 Boring No: SW-2
 Diameter: 8 in
 Date: 08/08/2013

Northing (ft): 431594.89
 Easting (ft): 861479.17
 Elevation (ft): 9.75
 Total Depth: 49.5 Ft

Driller: Groundwater Protection Inc
 Method: Mud Rotary
 Consultant: Mutch Associates
 Project No: 448517

Datum: NAVD88
 Coordinate System:
 NAD 1983 State Plane
 Georgia East / FIPS 1001

Depth Ft	Recov	Sample ID	Blow Count	PID (ppm)	Mercury (mg/m3)	USCS Code	Soil Description	Well Construction Diagram
30							Brown gray drilling MUD, pH 7 to 8.	
35				1.6	0			
40			9	0	0	SM	Gray fine to coarse SAND, trace silt.	
			12					
			13			SM/ML	Gray fine to coarse SAND, trace silt, layer 2 inch clay and silt.	
			14					
			11	0	0	SM	Gray fine to coarse SAND, trace silt.	
			10					
			11			CL	Gray CLAY and silt, little sand, some white shell fragments.	
			12					
			12					
			19	0	0	SM	Gray fine to coarse SAND, trace silt, trace white shell fragments.	
45								

BORING LOG



Site Name: LCP Chemicals Site, Brunswick GA
 Boring No: SW-2
 Diameter: 8 in
 Date: 08/08/2013

Northing (ft): 431594.89
 Easting (ft): 861479.17
 Elevation (ft): 9.75
 Total Depth: 49.5 Ft

Driller: Groundwater Protection Inc
 Method: Mud Rotary
 Consultant: Mutch Associates
 Project No: 448517

Datum: NAVD88
 Coordinate System:
 NAD 1983 State Plane
 Georgia East / FIPS 1001

Depth Ft	Recov	Sample ID	Blow Count	PID (ppm)	Mercury (mg/m3)	USCS Code	Soil Description	Well Construction Diagram
45			19	0	0	SM	Gray fine to medium SAND, little silt, little white shell fragments.	
			23			SM	Gray fine to medium SAND, trace silt, trace white shell fragments.	
			14			SM	Gray fine to medium SAND, trace silt, trace white shell fragments.	
			19			SM	Gray fine to medium SAND, trace silt, trace white shell fragments.	
			20			SM	Gray fine to medium SAND, trace silt, trace white shell fragments.	
			23					
			10	0	0	SM	Gray fine to medium SAND, trace silt.	
			17			SM	Gray fine to medium SAND, trace silt.	
			50			SM/R	4 in Gray fine to coarse SAND, little silt, 2 in weakly cemented sandstone.	
49.5								

Well Set at 49.5 ft.

BORING LOG



Site Name: LCP Chemicals Site, Brunswick GA
 Boring No: SW-3
 Diameter: 8 in
 Date: 08/08/2013

Northing (ft): 431675.46
 Easting (ft): 861477.79
 Elevation (ft): 9.10
 Total Depth: 49.0 Ft

Driller: Groundwater Protection Inc
 Method: Mud Rotary
 Consultant: Mutch Associates
 Project No: 448517

Datum: NAVD88
 Coordinate System:
 NAD 1983 State Plane
 Georgia East / FIPS 1001

Depth Ft	Recov	Sample ID	Blow Count	PID (ppm)	Mercury (mg/m3)	USCS Code	Soil Description	Well Construction Diagram
30							Brown gray drilling MUD, pH 7 to 8.	
35				7.7	0			
40			11	0	0	SC	Gray fine to medium SAND, and silt and clay.	
			10					
			10			SC	Gray fine to medium SAND, and silt and clay.	
			13					
			12	0	0	SM	Gray fine to medium SAND, trace silt, trace white shell fragments.	
			13					
			19			SM	Gray fine to medium SAND, trace silt, trace white shell fragments.	
			25					
			13	0	0	SM	Gray fine to medium SAND, trace silt, trace white shell fragments.	
45			17					

BORING LOG



Site Name: LCP Chemicals Site, Brunswick GA
 Boring No: SW-3
 Diameter: 8 in
 Date: 08/08/2013

Northing (ft): 431675.46
 Easting (ft): 861477.79
 Elevation (ft): 9.10
 Total Depth: 49.0 Ft

Driller: Groundwater Protection Inc
 Method: Mud Rotary
 Consultant: Mutch Associates
 Project No: 448517

Datum: NAVD88
 Coordinate System:
 NAD 1983 State Plane
 Georgia East / FIPS 1001

Depth Ft	Recov	Sample ID	Blow Count	PID (ppm)	Mercury (mg/m3)	USCS Code	Soil Description	Well Construction Diagram
45			24	0	0	SM	Gray fine to medium SAND, trace silt, trace white shell fragments.	
			30			SM	Gray fine to medium SAND, trace silt, trace white shell fragments.	
			17			SM	Gray fine to medium SAND, trace silt, trace white shell fragments.	
			26			SM	Gray fine to medium SAND, trace silt, trace white shell fragments.	
			37	0	0	SM	Gray fine to medium SAND, trace silt, trace white shell fragments.	
			42			SM/R	Gray fine to medium SAND, some silt, trace white shell fragments, cemented sandstone in tip.	
			14					
			32					

49.0

Well Set at 48 ft.

BORING LOG



Site Name: LCP Chemicals Site, Brunswick GA
 Boring No: SW-4
 Diameter: 8 in
 Date: 07/31/2013

Northing (ft): 431752.69
 Easting (ft): 861478.76
 Elevation (ft): 9.01
 Total Depth: 50.42 Ft

Driller: Groundwater Protection Inc
 Method: Mud Rotary
 Consultant: Mutch Associates
 Project No: 448517

Datum: NAVD88
 Coordinate System:
 NAD 1983 State Plane
 Georgia East / FIPS 1001

Depth Ft	Recov	Sample ID	Blow Count	PID (ppm)	Mercury (mg/m3)	USCS Code	Soil Description	Well Construction Diagram
30							Brown gray drilling MUD, pH is 7.	
35				0.5	0			
40			17	0	0	CL	Gray CLAY, medium plasticity.	
			15					
			11			SM	Gray fine to coarse SAND, trace silt.	
			11					
			11	0	0	SM	Gray fine to coarse SAND, trace silt, trace gravel, trace white shell fragments.	
			17					
			25			SM	Gray fine to coarse SAND, trace silt, trace gravel, trace white shell fragments.	
			22					
			15					
45			21	0	0	SM	Gray fine to coarse SAND, trace silt, trace white shell fragments.	

BORING LOG



Site Name: LCP Chemicals Site, Brunswick GA
 Boring No: SW-4
 Diameter: 8 in
 Date: 07/31/2013

Northing (ft): 431752.69
 Easting (ft): 861478.76
 Elevation (ft): 9.01
 Total Depth: 50.42 Ft

Driller: Groundwater Protection Inc
 Method: Mud Rotary
 Consultant: Mutch Associates
 Project No: 448517

Datum: NAVD88
 Coordinate System:
 NAD 1983 State Plane
 Georgia East / FIPS 1001

Depth Ft	Recov	Sample ID	Blow Count	PID (ppm)	Mercury (mg/m3)	USCS Code	Soil Description	Well Construction Diagram
45			27	0	0	SM	Gray fine to coarse SAND, trace silt, trace white shell fragments.	
			29			SM	Gray fine to medium SAND, trace silt, trace white shell fragments.	
			13			SM	Gray fine to medium SAND, trace silt, trace white shell fragments.	
			22			SM	Gray fine to medium SAND, trace silt, trace white shell fragments.	
			28	0	0	SM	Gray fine to medium SAND, trace silt, trace white shell fragments.	
			31			SM	Gray fine to medium SAND, trace silt, trace white shell fragments.	
			15			SM	Gray fine to medium SAND, trace silt, trace white shell fragments.	
			22			SM	Gray fine to medium SAND, trace silt, trace white shell fragments, pH 10.	
			14	0	0	SM	Gray fine to medium SAND, trace silt, trace white shell fragments, pH 10.	
			14			SM	Gray fine to medium SAND, trace silt, trace white shell fragments, pH 10.	
50			50	0	0	SM	Gray fine to coarse SAND, trace gravel, weakly cemented sandstone.	
50.42								

Well Set at 50.5 ft.

BORING LOG



Site Name: LCP Chemicals Site, Brunswick GA
 Boring No: SW-5
 Diameter: 8 in
 Date: 07/30/2013

Northing (ft): 431835.72
 Easting (ft): 861478.13
 Elevation (ft): 9.00
 Total Depth: 50.9 Ft

Driller: Groundwater Protection Inc
 Method: Mud Rotary
 Consultant: PARSONS
 Project No: 448517

Datum: NAVD88
 Coordinate System:
 NAD 1983 State Plane
 Georgia East / FIPS 1001

Depth Ft	Recov	Sample ID	Blow Count	PID (ppm)	Mercury (mg/m3)	USCS Code	Soil Description	Well Construction Diagram
45			4			SM	Coarse SAND over greenish gray fine to medium sand, little silt, trace clay in lenses, soft, wet.	
			5					
			3	0.0	0.000		Fine to medium SAND, trace silt, soft, wet.	
			17					
			8			SM		
			14					
			22	0.0	0.000	SM	Trace white carbonate rocks in shoe.	
			32	0.0	0.000	SM	Gray fine to medium SAND, trace shells, trace silt, soft, wet.	
			50	0.0	0.000	SM	Same as above, noted slight sheen on mud.	
			25	0.0	0.000	SM	Same as above.	
50			20	0.0	0.000	SM	Gray fine SAND, some silt, trace shells, wet.	
51.0			50	0.0	0.000	SM	Same as above over trace sandstone, poor recovery in top, hard refusal.	

Well Set at 50.5 ft.

BORING LOG



Site Name: LCP Chemicals Site, Brunswick GA

Boring No: SW-6

Diameter: 8 in

Date: 07/30/2013

Northing (ft): 431915.23
 Easting (ft): 861477.25
 Elevation (ft): 7.95
 Total Depth: 51.0 Ft

Driller: Groundwater Protection Inc
 Method: Mud Rotary
 Consultant: PARSONS
 Project No: 448517

Datum: NAVD88
 Coordinate System:
 NAD 1983 State Plane
 Georgia East / FIPS 1001

Depth Ft	Recov	Sample ID	Blow Count	PID (ppm)	Mercury (mg/m3)	USCS Code	Soil Description	Well Construction Diagram
0							Hand cleared to 5 feet. Installed with a stick up above ground surface. pH is 7.	
5				0.0	0.000			
10							Mud rotary 5-40 feet, no samples. pH is 7.	
15				0.0	0.000			

BORING LOG



Site Name: LCP Chemicals Site, Brunswick GA
 Boring No: SW-6
 Diameter: 8 in
 Date: 07/30/2013

Northing (ft): 431915.23
 Easting (ft): 861477.25
 Elevation (ft): 7.95
 Total Depth: 51.0 Ft

Driller: Groundwater Protection Inc
 Method: Mud Rotary
 Consultant: PARSONS
 Project No: 448517

Datum: NAVD88
 Coordinate System:
 NAD 1983 State Plane
 Georgia East / FIPS 1001

Depth Ft	Recov	Sample ID	Blow Count	PID (ppm)	Mercury (mg/m3)	USCS Code	Soil Description	Well Construction Diagram
45			10	0.0	0.000	SM	Gray fine to medium SAND, wet.	
			9			SM	Gray fine to medium SAND, little silt, trace shells, trace carbonate rock pebble, wet.	
			8					
			9					
			12					
			11					
			20			SM	Gray fine to medium SAND, little silt, trace shells, trace carbonate rock pebble, wet.	
			15					
			18					
			50					
18	SM	Same as above, trace bedrock pebbles in bottom of sample sandstone.						
51.0			50/2	0.0	0.000	SM		

Well Set at 51 ft.

BORING LOG



Site Name: LCP Chemicals Site, Brunswick GA
 Boring No: SW-7
 Diameter: 8 in
 Date: 08/09/2013

Northing (ft): 431394.30
 Easting (ft): 861547.34
 Elevation (ft): 9.64
 Total Depth: 50.5 Ft

Driller: Groundwater Protection Inc
 Method: Mud Rotary
 Consultant: Mutch Associates
 Project No: 448517

Datum: NAVD88
 Coordinate System:
 NAD 1983 State Plane
 Georgia East / FIPS 1001

Depth Ft	Recov	Sample ID	Blow Count	PID (ppm)	Mercury (mg/m3)	USCS Code	Soil Description	Well Construction Diagram
30							Brown gray drilling MUD, pH 7 to 8.	
35				80	0			
40			5	0	0	SM	Gray fine to coarse SAND, trace silt.	
			7					
			6			SM	Gray fine to coarse SAND, trace silt.	
			6					
			4	0	0	SM	Gray fine to coarse SAND, trace silt.	
			6					
			10					
			12			CL	Gray CLAY and silt, little sand.	
			7					
			8	0	0	SM	Gray fine to coarse SAND, trace silt.	
45								

BORING LOG



Site Name: LCP Chemicals Site, Brunswick GA
 Boring No: SW-7
 Diameter: 8 in
 Date: 08/09/2013

Northing (ft): 431394.30
 Easting (ft): 861547.34
 Elevation (ft): 9.64
 Total Depth: 50.5 Ft

Driller: Groundwater Protection Inc
 Method: Mud Rotary
 Consultant: Mutch Associates
 Project No: 448517

Datum: NAVD88
 Coordinate System:
 NAD 1983 State Plane
 Georgia East / FIPS 1001

Depth Ft	Recov	Sample ID	Blow Count	PID (ppm)	Mercury (mg/m3)	USCS Code	Soil Description	Well Construction Diagram
45			11	0	0	SM	Gray fine to coarse SAND, trace silt.	
			17			SM	Gray brown fine to medium SAND, trace silt, trace white shell fragments.	
			3			SM	Gray brown fine to medium SAND, trace silt, trace white shell fragments.	
			4			SM	Gray brown fine to medium SAND, trace silt, trace white shell fragments.	
			7	SM	Gray brown fine to medium SAND, trace silt, trace white shell fragments.			
			11	SM	Gray brown fine to medium SAND, trace silt.			
			8	SM	Gray brown fine to medium SAND, trace silt.			
			15	SM	Gray brown fine to medium SAND, trace silt.			
			13	SM	Gray brown fine to medium SAND, trace silt.			
			10	SM	Gray brown fine to medium SAND, trace silt.			
50			50	SM	3 in Gray brown fine to medium SAND, little silt, 3 in weakly cemented sandstone.			

Well Set at 50 ft.

BORING LOG



Site Name: LCP Chemicals Site, Brunswick GA
 Boring No: SW-8
 Diameter: 8 in
 Date: 08/05/2013

Northing (ft): 431473.97
 Easting (ft): 861547.59
 Elevation (ft): 9.53
 Total Depth: 50.25 Ft

Driller: Groundwater Protection Inc
 Method: Mud Rotary
 Consultant: Mutch Associates
 Project No: 448517

Datum: NAVD88
 Coordinate System:
 NAD 1983 State Plane
 Georgia East / FIPS 1001

Depth Ft	Recov	Sample ID	Blow Count	PID (ppm)	Mercury (mg/m3)	USCS Code	Soil Description	Well Construction Diagram
30							Brown gray drilling MUD, pH 7.	
35				0	0			
40			8	0	0	SM	Gray fine to coarse SAND, trace silt.	
			8					
			12					
			13			SM	Gray fine to medium SAND, little silt.	
			4	0	0	SM	Gray fine to medium SAND, little silt.	
			4					
			5					
			7			SM	Gray fine to medium SAND, little silt.	
45			9	0	0	SM	Gray fine to medium SAND, little silt, little layers of shells, occasional lens clay.	
			12					

BORING LOG



Site Name: LCP Chemicals Site, Brunswick GA
 Boring No: SW-8
 Diameter: 8 in
 Date: 08/05/2013

Northing (ft): 431473.97
 Easting (ft): 861547.59
 Elevation (ft): 9.53
 Total Depth: 50.25 Ft

Driller: Groundwater Protection Inc
 Method: Mud Rotary
 Consultant: Mutch Associates
 Project No: 448517

Datum: NAVD88
 Coordinate System:
 NAD 1983 State Plane
 Georgia East / FIPS 1001

Depth Ft	Recov	Sample ID	Blow Count	PID (ppm)	Mercury (mg/m3)	USCS Code	Soil Description	Well Construction Diagram		
45			15	0	0	SC	Gray fine to medium SAND, little silt, little layers of shells, occasional lens clay.			
			50							
			18						SM	Gray fine to medium SAND, trace silt, trace white shell fragments.
			18							
			20			SM	Gray fine to medium SAND, trace silt, trace white shell fragments.			
			22							
			12		0	0	SM		Gray fine to medium SAND, trace silt, trace white shell fragments.	
			18							
			11				SM		49 ft to 49 ft 6 in Gray fine to medium SAND, trace silt, trace white shell fragments, 49 ft 6 in to 50 ft Gray fine to coarse SAND, little silt, trace gravel.	
			9							
50			50	0	0	SM/R	Gray weakly cemented SANDSTONE, some fine to coarse sand.			
50.25										

Well Set at 50 ft.

BORING LOG



Site Name: LCP Chemicals Site, Brunswick GA
 Boring No: SW-9
 Diameter: 8 in
 Date: 08/06/2013

Northing (ft): 431555.73
 Easting (ft): 861546.71
 Elevation (ft): 9.27
 Total Depth: 49.75 Ft

Driller: Groundwater Protection Inc
 Method: Mud Rotary
 Consultant: Mutch Associates
 Project No: 448517

Datum: NAVD88
 Coordinate System:
 NAD 1983 State Plane
 Georgia East / FIPS 1001

Depth Ft	Recov	Sample ID	Blow Count	PID (ppm)	Mercury (mg/m3)	USCS Code	Soil Description	Well Construction Diagram
30							Brown gray drilling MUD, pH is 7.	
35				0	0			
40			8	0	0	SM	Gray fine to coarse SAND, trace silt.	
			7					
			8			SM	Gray fine to coarse SAND, trace silt.	
			15					
			11	0	0	SM	Gray fine to coarse SAND, trace silt.	
			15					
			16			SM	Gray fine to medium SAND, little silt, little white shell fragments.	
			17					
			15	0	0	SM	Gray fine to medium SAND, trace silt, trace layers of shells.	
45			17					

BORING LOG



Site Name: LCP Chemicals Site, Brunswick GA
 Boring No: SW-9
 Diameter: 8 in
 Date: 08/06/2013

Northing (ft): 431555.73
 Easting (ft): 861546.71
 Elevation (ft): 9.27
 Total Depth: 49.75 Ft

Driller: Groundwater Protection Inc
 Method: Mud Rotary
 Consultant: Mutch Associates
 Project No: 448517

Datum: NAVD88
 Coordinate System:
 NAD 1983 State Plane
 Georgia East / FIPS 1001

Depth Ft	Recov	Sample ID	Blow Count	PID (ppm)	Mercury (mg/m3)	USCS Code	Soil Description	Well Construction Diagram
45			20	0	0	SM	Gray fine to medium SAND, trace silt, trace layers of shells.	
			26			SM	Gray fine to medium SAND, trace silt, trace white shell fragments, pH 10.	
			11				Gray fine to medium SAND, trace silt, trace white shell fragments, pH 10.	
			15				Gray fine to medium SAND, trace silt, trace white shell fragments, pH 10.	
			17	0	0	SM	Gray fine to coarse SAND, trace silt.	
			15					
			8					
			12					
			18			SM/R	49 ft to 49 ft 6 in Gray fine to coarse SAND, trace silt, 49 ft 6 in to 9 in 2 in fine to coarse SAND, trace silt, 1 in weakly cemented sandstone.	
49.75			50					

Well Set at 49.5 ft.

BORING LOG



Site Name: LCP Chemicals Site, Brunswick GA
 Boring No: SW-10
 Diameter: 8 in
 Date: 08/06/2013

Northing (ft): 431634.58
 Easting (ft): 861547.06
 Elevation (ft): 9.27
 Total Depth: 49.67 Ft

Driller: Groundwater Protection Inc
 Method: Mud Rotary
 Consultant: Mutch Associates
 Project No: 448517

Datum: NAVD88
 Coordinate System:
 NAD 1983 State Plane
 Georgia East / FIPS 1001

Depth Ft	Recov	Sample ID	Blow Count	PID (ppm)	Mercury (mg/m3)	USCS Code	Soil Description	Well Construction Diagram
30							Brown gray drilling MUD, pH 7.	
35				0	0			
40			5	0	0	SC	Gray fine to coarse SAND, trace silt, 2 in layer of Gray clay.	
			6					
			18			SC	Gray fine to coarse SAND, some silty clay, trace white shell fragments.	
			24					
			11	0	0	SC	Gray fine to coarse SAND, little clayey silt, trace white shell fragments.	
			11					
			15			SC	Gray fine to coarse SAND, little clayey silt, trace white shell fragments.	
			17					
			10					
			19	0	0	SM	Gray brown fine to medium SAND, trace silt, little white shell fragments.	
45								

BORING LOG



Site Name: LCP Chemicals Site, Brunswick GA
 Boring No: SW-10
 Diameter: 8 in
 Date: 08/06/2013

Northing (ft): 431634.58
 Easting (ft): 861547.06
 Elevation (ft): 9.27
 Total Depth: 49.67 Ft

Driller: Groundwater Protection Inc
 Method: Mud Rotary
 Consultant: Mutch Associates
 Project No: 448517

Datum: NAVD88
 Coordinate System:
 NAD 1983 State Plane
 Georgia East / FIPS 1001

Depth Ft	Recov	Sample ID	Blow Count	PID (ppm)	Mercury (mg/m3)	USCS Code	Soil Description	Well Construction Diagram
45			26	0	0	SM	Gray brown fine to medium SAND, trace silt, little white shell fragments.	
			31			SM	Gray fine to medium SAND, trace silt, trace white shell fragments.	
			13			SM	Gray fine to medium SAND, trace silt, trace white shell fragments.	
			21			SM	Gray fine to medium SAND, trace silt, trace white shell fragments.	
			20					
			19					
			8	0	0	SM	Gray fine to medium SAND, trace silt, trace white shell fragments.	
			9			SM	Gray fine to medium SAND, trace silt, trace white shell fragments.	
			8			SM/R	49 ft to 49 ft 6 in Gray fine to coarse SAND, little silt, pH over 10, 49 ft 6 in to 49 ft 8 in weakly cemented SANDSTONE.	
49.75			50					

Well Set at 49.5 ft.

BORING LOG



Site Name: LCP Chemicals Site, Brunswick GA
 Boring No: SW-11
 Diameter: 8 in
 Date: 07/31/2013 - 08/05/2013

Northing (ft): 431713.54
 Easting (ft): 861547.45
 Elevation (ft): 8.80
 Total Depth: 51.5 Ft

Driller: Groundwater Protection Inc
 Method: Mud Rotary
 Consultant: Mutch Associates
 Project No: 448517

Datum: NAVD88
 Coordinate System:
 NAD 1983 State Plane
 Georgia East / FIPS 1001

Depth Ft	Recov	Sample ID	Blow Count	PID (ppm)	Mercury (mg/m3)	USCS Code	Soil Description	Well Construction Diagram
45			17	0	0	SM	Gray fine to medium SAND, trace silt, trace white shell fragments.	
			23			SM	Gray fine to medium SAND, trace silt, trace white shell fragments.	
			10			SM	Gray fine to medium SAND, trace silt, trace white shell fragments.	
			17			SM	Gray fine to medium SAND, trace silt, trace white shell fragments.	
			19	0	0	SM	Gray fine to medium SAND, trace silt, trace white shell fragments.	
			20			SM	Gray fine to medium SAND, trace silt, trace white shell fragments.	
			12			SM	Gray fine to medium SAND, trace silt, trace white shell fragments.	
			17			SM	Gray fine to medium SAND, trace silt, trace white shell fragments.	
			7	0	0	SM	Gray fine to medium SAND, trace silt, trace white shell fragments.	
			14			SM	Gray fine to medium SAND, trace silt, trace white shell fragments.	
50			14			SM	Gray fine to medium SAND, trace silt, trace white shell fragments, note 50 ft 6 in to 51 ft little silt.	
			13			SM	Gray fine to medium SAND, trace silt, trace white shell fragments.	
51.6			50			SM/R	Gray fine to coarse SAND, little silt, trace white shell fragments, pieces weakly cemented stone in tip.	

Well Set at 51.5 ft.

BORING LOG



Site Name: LCP Chemicals Site, Brunswick GA
 Boring No: SW-12
 Diameter: 8 in
 Date: 07/27/2013

Northing (ft): 431794.62
 Easting (ft): 861546.84
 Elevation (ft): 9.18
 Total Depth: 51.25 Ft

Driller: Groundwater Protection Inc
 Method: Mud Rotary
 Consultant: Mutch Associates
 Project No: 448517

Datum: NAVD88
 Coordinate System:
 NAD 1983 State Plane
 Georgia East / FIPS 1001

Depth Ft	Recov	Sample ID	Blow Count	PID (ppm)	Mercury (mg/m3)	USCS Code	Soil Description	Well Construction Diagram
30							Brown drilling MUD, pH 7 to 8.	
35				28.5	0			
40			6	0	0	SC	Gray brown fine to coarse SAND, trace silt, occasional lens clay.	
			10					
			12			SC	41 ft to 41 ft 6 in Gray brown fine to coarse SAND, trace silt, occasional lens clay, 41 ft 6 in to 42 ft graduated fine to medium SAND, some clay and silt.	
			14					
			5	0	0	SM	Gray brown fine coarse SAND, trace silt.	
			9					
			11			SM	43 ft to 43 ft 6 in Gray brown fine to coarse SAND, trace silt, 43 ft 6 in to 44 ft Gray fine to medium SAND, trace silt and clay.	
			10					
			4	0	0	SM	44 ft 6 in to 45 ft Gray fine to medium SAND, trace silt, trace white shell fragments.	
45			4					

BORING LOG



Site Name: LCP Chemicals Site, Brunswick GA
 Boring No: SW-12
 Diameter: 8 in
 Date: 07/27/2013

Northing (ft): 431794.62
 Easting (ft): 861546.84
 Elevation (ft): 9.18
 Total Depth: 51.25 Ft

Driller: Groundwater Protection Inc
 Method: Mud Rotary
 Consultant: Mutch Associates
 Project No: 448517

Datum: NAVD88
 Coordinate System:
 NAD 1983 State Plane
 Georgia East / FIPS 1001

Depth Ft	Recov	Sample ID	Blow Count	PID (ppm)	Mercury (mg/m3)	USCS Code	Soil Description	Well Construction Diagram		
45			30	0	0	SM	Gray fine to medium SAND, trace silt, trace white shell fragments.			
			50							
			34							
				50			SM		Fine to medium SAND, trace silt, trace white shell fragments.	
							SM		Fine to medium SAND, trace silt, trace white shell fragments, pH 10.	
				33	0	0	SC		48 ft to 48 ft 6 in Gray fine to medium SAND, some silty clay, 48 ft 6 in to 49 ft Gray CLAY, some sand.	
				21						
				20						
				15			SM		Fine to medium SAND, trace silt, trace white shell fragments.	
50				15	0	0	SM		Fine to medium SAND, trace silt, trace white shell fragments, sandstone in tip of spoon.	
				14						
				50						SM/R
51.25				Well Set at 51 ft.						

BORING LOG



Site Name: LCP Chemicals Site, Brunswick GA
 Boring No: SW-13
 Diameter: 8 in
 Date: 07/27/2013

Northing (ft): 431874.76
 Easting (ft): 861546.56
 Elevation (ft): 8.69
 Total Depth: 50.5 Ft

Driller: Groundwater Protection Inc
 Method: Mud Rotary
 Consultant: Mutch Associates
 Project No: 448517

Datum: NAVD88
 Coordinate System:
 NAD 1983 State Plane
 Georgia East / FIPS 1001

Depth Ft	Recov	Sample ID	Blow Count	PID (ppm)	Mercury (mg/m3)	USCS Code	Soil Description	Well Construction Diagram
30							Brown drilling MUD, pH 7 to 8.	
35				0.5	0			
40			6	0	0	SC	Gray brown fine to coarse SAND, trace silt, occasional lens clay.	
			13					
			13			SC	Gray brown fine to coarse SAND, trace silt, occasional lens clay.	
			6	0	0	SC	Gray brown fine to coarse SAND, trace silt, occasional lens clay.	
			6					
			8					
			7			SC	Gray brown fine to coarse SAND, trace silt, occasional lens clay.	
			4					
45			4	0	0	SM	Gray fine to medium SAND, trace silt.	

BORING LOG



Site Name: LCP Chemicals Site, Brunswick GA
 Boring No: SW-13
 Diameter: 8 in
 Date: 07/27/2013

Northing (ft): 431874.76
 Easting (ft): 861546.56
 Elevation (ft): 8.69
 Total Depth: 50.5 Ft

Driller: Groundwater Protection Inc
 Method: Mud Rotary
 Consultant: Mutch Associates
 Project No: 448517

Datum: NAVD88
 Coordinate System:
 NAD 1983 State Plane
 Georgia East / FIPS 1001

Depth Ft	Recov	Sample ID	Blow Count	PID (ppm)	Mercury (mg/m3)	USCS Code	Soil Description	Well Construction Diagram
45			8	0	0	SM	Gray fine to medium SAND, trace silt.	
			8			SM	Gray fine to medium SAND, trace silt.	
			5			SM	Gray fine to medium SAND, trace silt.	
			13			SM	Gray fine to medium SAND, trace silt.	
			50	0	0	SM	Gray fine to medium SAND, trace silt, trace white shell fragments.	
			6			SM	Gray fine to medium SAND, trace silt, trace white shell fragments.	
			34			SM	49 ft to 49 ft 6 in Gray fine to medium SAND, little clayey silt, trace white shell fragments, 49 ft 6 in to 50 ft Gray fine to medium SAND, little silt, 1/8 inch layers of white shell fragments	
			16			SM	49 ft to 49 ft 6 in Gray fine to medium SAND, little clayey silt, trace white shell fragments, 49 ft 6 in to 50 ft Gray fine to medium SAND, little silt, 1/8 inch layers of white shell fragments	
50			13	0	0	SM	Gray fine to coarse SAND, trace silt, sandstone fragments in tip of spoon.	
50.6			50			SM	Gray fine to coarse SAND, trace silt, sandstone fragments in tip of spoon.	

Well Set at 50.5 ft.

BORING LOG



Site Name: LCP Chemicals Site, Brunswick GA

Boring No: SW-14

Diameter: 8 in

Date: 07/27/2013

Northing (ft): 431955.20
 Easting (ft): 861545.79
 Elevation (ft): 8.25
 Total Depth: 48.9 Ft

Driller: Groundwater Protection Inc
 Method: Mud Rotary
 Consultant: PARSONS
 Project No: 448517

Datum: NAVD88
 Coordinate System:
 NAD 1983 State Plane
 Georgia East / FIPS 1001

Depth Ft	Recov	Sample ID	Blow Count	PID (ppm)	Mercury (mg/m3)	USCS Code	Soil Description	Well Construction Diagram
0							Hand cleared to 5 ft. Installed with a stick up above ground surface. pH is 7.	
5				0.4	0.0			
10						pH is 7.		
15				0.5	0.0			

BORING LOG



Site Name: LCP Chemicals Site, Brunswick GA
 Boring No: SW-14
 Diameter: 8 in
 Date: 07/27/2013

Northing (ft): 431955.20
 Easting (ft): 861545.79
 Elevation (ft): 8.25
 Total Depth: 48.9 Ft

Driller: Groundwater Protection Inc
 Method: Mud Rotary
 Consultant: PARSONS
 Project No: 448517

Datum: NAVD88
 Coordinate System:
 NAD 1983 State Plane
 Georgia East / FIPS 1001

Depth Ft	Recov	Sample ID	Blow Count	PID (ppm)	Mercury (mg/m3)	USCS Code	Soil Description	Well Construction Diagram
30							Drilled to 40 ft with mud rotary, no sampling to 40 ft. pH is 7.	
35				0.4	0.0			
40			10	0.0	0.00	SM	Light medium gray medium to coarse SAND, little fine sand, 1 inch lense of fine to medium sand, little clay, wet, swampy odor, no stain or sheen.	
			14					
			13					
			8					
			7	0.0	0.000	SM	Light gray and gray medium to coarse SAND, 2 inch lense of clay, little silt, bottom 5 inches gray fine sand, little silt, trace clay, wet.	
			6					
			4					
			4			SM	Gray medium SAND, some fine sand, bottom 7 inches has trace broken shells, wet.	
			8					
45			21	0.0	0.00			

BORING LOG



Site Name: LCP Chemicals Site, Brunswick GA
 Boring No: SW-14
 Diameter: 8 in
 Date: 07/27/2013

Northing (ft): 431955.20
 Easting (ft): 861545.79
 Elevation (ft): 8.25
 Total Depth: 48.9 Ft

Driller: Groundwater Protection Inc
 Method: Mud Rotary
 Consultant: PARSONS
 Project No: 448517

Datum: NAVD88
 Coordinate System:
 NAD 1983 State Plane
 Georgia East / FIPS 1001

Depth Ft	Recov	Sample ID	Blow Count	PID (ppm)	Mercury (mg/m3)	USCS Code	Soil Description	Well Construction Diagram					
45	[Diagram]		18	0.0	0.00	SM	Gray medium SAND, some fine sand, bottom 7 inches has trace broken shells, wet.	[Diagram]					
			20										
			23			SM	Gray medium SAND, some fine sand, trace shells broken, wet, swampy odor, still no stain or odor.						
			18										
			19										
			49.0			[Diagram]			24	0.2	0.00	SM	Gray fine SAND, little shells, some silt, little trace clay, wet.
									11			SM	Gray fine to medium SAND, trace sandstone gravel, bottom cemented sand sandstone, wet. Refusal, stop drilling and set well.
			50/5	0.0	0.00								

Well Set at 49 ft.

BORING LOG



Site Name: LCP Chemicals Site, Brunswick GA
 Boring No: SW-15
 Diameter: 8 in
 Date: 08/11/2013 - 08/12/2013

Northing (ft): 431354.05
 Easting (ft): 861616.43
 Elevation (ft): 9.16
 Total Depth: 48.83 Ft

Driller: Groundwater Protection Inc
 Method: Mud Rotary
 Consultant: Mutch Associates
 Project No: 448517

Datum: NAVD88
 Coordinate System:
 NAD 1983 State Plane
 Georgia East / FIPS 1001

Depth Ft	Recov	Sample ID	Blow Count	PID (ppm)	Mercury (mg/m3)	USCS Code	Soil Description	Well Construction Diagram
45			17	0	0	CL	Gray CLAY, stiff, layers of 1/4 inch fine to medium sand, trace silt.	
			18			SM	Gray fine to coarse SAND, trace silt.	
			13			SM	Gray fine to coarse SAND, trace silt, trace white shell fragments.	
			17			SM/R	Gray fine to coarse SAND, trace silt, trace gravel, cemented sandstone in tip of spoon.	
			20					
			20					
			9					
			50					

49.0

Well Set at 49 ft.

BORING LOG



Site Name: LCP Chemicals Site, Brunswick GA

Boring No: SW-16

Diameter: 8 in

Date: 08/07/2013

Northing (ft): 431434.89
 Easting (ft): 861616.53
 Elevation (ft): 9.84
 Total Depth: 51.5 Ft

Driller: Groundwater Protection Inc
 Method: Mud Rotary
 Consultant: Mutch Associates
 Project No: 448517

Datum: NAVD88
 Coordinate System:
 NAD 1983 State Plane
 Georgia East / FIPS 1001

Depth Ft	Recov	Sample ID	Blow Count	PID (ppm)	Mercury (mg/m3)	USCS Code	Soil Description	Well Construction Diagram
30							Brown gray drilling MUD, pH 7.	
35				2.3	0			
40			8	0	0	SM	Gray fine to medium SAND, trace silt.	
			8					
			9			SM	Gray fine to medium SAND, trace silt.	
			9					
			6	0	0	SM	Gray fine to medium SAND, trace silt, occasional piece of 1/2 inch white jagged rock.	
			8					
			9			SM	Gray fine to medium SAND, trace silt, occasional piece of 1/2 inch white jagged rock.	
			13					
			9	0	0	SM	Gray brown fine to coarse SAND, little silt, occasional piece of 1/2 inch white rock.	
45			17					

BORING LOG

Site Name: LCP Chemicals Site, Brunswick GA
 Boring No: SW-16
 Diameter: 8 in
 Date: 08/07/2013



Northing (ft): 431434.89
 Easting (ft): 861616.53
 Elevation (ft): 9.84
 Total Depth: 51.5 Ft

Driller: Groundwater Protection Inc
 Method: Mud Rotary
 Consultant: Mutch Associates
 Project No: 448517

Datum: NAVD88
 Coordinate System:
 NAD 1983 State Plane
 Georgia East / FIPS 1001

Depth Ft	Recov	Sample ID	Blow Count	PID (ppm)	Mercury (mg/m3)	USCS Code	Soil Description	Well Construction Diagram
45			15	0	0	SC	Gray fine SAND, little silt, layer 2 inch Gray silty clay, stiff.	
			17			SC	Gray brown fine to coarse SAND, little silt, trace white shell fragments, layer 2 inch Gray silty clay.	
			5			SM	Gray brown fine to coarse SAND, little silt, trace white shell fragments.	
			4			SM	Gray brown fine to coarse SAND, trace silt, trace white shell fragments.	
			9	0	0	SM	Gray brown fine to medium SAND, trace silt, trace white shell fragments.	
			20			SM	Gray fine to coarse SAND, little silt.	
			17			SM/R	3 in Gray fine to coarse SAND, little silt, 3 in weakly cemented Sandstone.	
			20					
			24	0	0	SM		
			24					
			8					
50			11					
51.5			50					

Well Set at 51 ft.

BORING LOG



Site Name: LCP Chemicals Site, Brunswick GA
 Boring No: SW-17
 Diameter: 8 in
 Date: 08/06/2013 - 08/07/2013

Northing (ft): 431515.71
 Easting (ft): 861616.70
 Elevation (ft): 9.85
 Total Depth: 50.75 Ft

Driller: Groundwater Protection Inc
 Method: Mud Rotary
 Consultant: Mutch Associates
 Project No: 448517

Datum: NAVD88
 Coordinate System:
 NAD 1983 State Plane
 Georgia East / FIPS 1001

Depth Ft	Recov	Sample ID	Blow Count	PID (ppm)	Mercury (mg/m3)	USCS Code	Soil Description	Well Construction Diagram
30							Brown gray drilling MUD, pH 7.	
35				0.2	0			
40			6	0	0	SM	Gray fine to coarse SAND, trace silt.	
			6					
			10					
			11			SM	Gray fine to coarse SAND, trace silt.	
			4	0	0	SM	Gray fine to coarse SAND, trace silt.	
			11					
			6			SM	Gray fine to coarse SAND, trace silt.	
			8					
			10					
45			9	0	0	SC	Gray fine to coarse SAND, trace silt, occasional lens clay and silt.	

BORING LOG



Site Name: LCP Chemicals Site, Brunswick GA
 Boring No: SW-17
 Diameter: 8 in
 Date: 08/06/2013 - 08/07/2013

Northing (ft): 431515.71
 Easting (ft): 861616.70
 Elevation (ft): 9.85
 Total Depth: 50.75 Ft

Driller: Groundwater Protection Inc
 Method: Mud Rotary
 Consultant: Mutch Associates
 Project No: 448517

Datum: NAVD88
 Coordinate System:
 NAD 1983 State Plane
 Georgia East / FIPS 1001

Depth Ft	Recov	Sample ID	Blow Count	PID (ppm)	Mercury (mg/m3)	USCS Code	Soil Description	Well Construction Diagram	
45	[RECOVERED]		6	0	0	SC	Gray fine to coarse SAND, trace silt, occasional lens clay and silt.	[WELL CONSTRUCTION DIAGRAM]	
		6							
		4							
		4							
		8							
		11							
		7			0	0	SM		Gray fine to medium SAND, trace silt.
		13							
		17							
		18							
50		9		0	0	SM/R	50 ft to 50 ft 6 in Gray fine to medium SAND, little silt, 50 ft 6 in to 50 ft 8 in Gray cemented sandstone.		
51.0		50							

Well Set at 50.5 ft.

BORING LOG



Site Name: LCP Chemicals Site, Brunswick GA
 Boring No: SW-19
 Diameter: 8 in
 Date: 07/24/2013

Northing (ft): 431678.01
 Easting (ft): 861610.69
 Elevation (ft): 9.74
 Total Depth: 46.5 Ft

Driller: Groundwater Protection Inc
 Method: Mud Rotary
 Consultant: PARSONS
 Project No: 448517

Datum: NAVD88
 Coordinate System:
 NAD 1983 State Plane
 Georgia East / FIPS 1001

Depth Ft	Recov	Sample ID	Blow Count	PID (ppm)	Mercury (mg/m3)	USCS Code	Soil Description	Well Construction Diagram
30							Mud rotary drilling, mud ph 7.	
35								
40			8	0.0	0.000	SM	Black and gray medium to coarse SAND, trace silt, wet.	
			11					
			16	0.0	0.000	SM	Black and gray medium to coarse SAND, trace silt, wet.	
			14					
			12	0.0	0.000	SM	Black and gray medium to coarse SAND, trace silt, wet.	
			11					
			9	0.0	0.000	SM	Black and gray medium to coarse SAND, trace silt, wet.	
			8					
			8	0.0	0.000	SM	Black and gray medium to coarse SAND, trace silt, wet.	
			8					
45			8	0.0	0.000	SM	Black and gray medium to coarse SAND, trace silt, wet.	

BORING LOG



Site Name: LCP Chemicals Site, Brunswick GA
 Boring No: SW-19
 Diameter: 8 in
 Date: 07/24/2013

Northing (ft): 431678.01
 Easting (ft): 861610.69
 Elevation (ft): 9.74
 Total Depth: 46.5 Ft

Driller: Groundwater Protection Inc
 Method: Mud Rotary
 Consultant: PARSONS
 Project No: 448517

Datum: NAVD88
 Coordinate System:
 NAD 1983 State Plane
 Georgia East / FIPS 1001

Depth Ft	Recov	Sample ID	Blow Count	PID (ppm)	Mercury (mg/m3)	USCS Code	Soil Description	Well Construction Diagram
45			9	0.0	0.000	SC	Gray fine SAND, trace clay, wet.	
			11					
46.5			50/1	0.0	0.000	GM	Gray coarse to very coarse SAND, and shells at 46.2 feet, mudstone and sand.	

Well set at 46 ft, ground elevation 9.23 ft.

BORING LOG



Site Name: LCP Chemicals Site, Brunswick GA
 Boring No: SW-20
 Diameter: 8 in
 Date: 07/25/2013

Northing (ft): 431754.07
 Easting (ft): 861615.36
 Elevation (ft): 8.98
 Total Depth: 51.5 Ft

Driller: Groundwater Protection Inc
 Method: Mud Rotary
 Consultant: PARSONS
 Project No: 448517

Datum: NAVD88
 Coordinate System:
 NAD 1983 State Plane
 Georgia East / FIPS 1001

Depth Ft	Recov	Sample ID	Blow Count	PID (ppm)	Mercury (mg/m3)	USCS Code	Soil Description	Well Construction Diagram
45			15	0.0	0.000	SC	Gray fine SAND, some clay, moist.	
			50					
			27	0.0	0.000	SC	Gray fine SAND, some shells, trace clay, moist.	
			30					
			37	0.0	0.000	SC	Gray fine SAND, some shells, trace clay, moist.	
			30					
			24	0.0	0.000	SC	Gray fine SAND, some shells, trace clay, moist.	
			16	0.0	0.000	SC	Gray fine SAND, some shells, trace clay, moist.	
			18	0.0	0.000	SC	Gray fine SAND, trace shells, trace clay, moist.	
			16	0.0	0.000	SC	Gray fine SAND, trace shells, trace clay, moist.	
50			24	0.0	0.000	SC	Gray fine SAND, trace shells, trace clay, moist.	
			20	0.0	0.000	SM	Gray fine SAND, some shells, laminated, moist.	
			44	0.0	0.000	SM	Gray fine sand, some shells, laminated, moist, cemented sandstone at 51.3 feet.	

Well set at 51 ft, ground elevation 8.42 ft.

BORING LOG



Site Name: LCP Chemicals Site, Brunswick GA
 Boring No: SW-21
 Diameter: 8 in
 Date: 07/25/2013

Northing (ft): 431835.20
 Easting (ft): 861616.10
 Elevation (ft): 9.25
 Total Depth: 46.5 Ft

Driller: Groundwater Protection Inc
 Method: Mud Rotary
 Consultant: PARSONS
 Project No: 448517

Datum: NAVD88
 Coordinate System:
 NAD 1983 State Plane
 Georgia East / FIPS 1001

Depth Ft	Recov	Sample ID	Blow Count	PID (ppm)	Mercury (mg/m3)	USCS Code	Soil Description	Well Construction Diagram
30							Mud rotary drilling, mud ph 7.	
40			6	0.0	0.000	SW	Gray medium to coarse SAND, trace gravel, wet.	
			9					
			12	0.0	0.000	SW	Gray medium to coarse SAND, trace gravel, wet.	
			12					
			8	0.0	0.000	SW	Gray medium to coarse SAND, trace gravel, wet.	
			10					
			10	0.0	0.000	SM	Gray fine to medium SAND, trace clay.	
			12					
			5	0.0	0.000	SM	Gray fine to medium SAND, trace silt, wet.	
45			7					

BORING LOG



Site Name: LCP Chemicals Site, Brunswick GA
 Boring No: SW-21
 Diameter: 8 in
 Date: 07/25/2013

Northing (ft): 431835.20
 Easting (ft): 861616.10
 Elevation (ft): 9.25
 Total Depth: 46.5 Ft

Driller: Groundwater Protection Inc
 Method: Mud Rotary
 Consultant: PARSONS
 Project No: 448517

Datum: NAVD88
 Coordinate System:
 NAD 1983 State Plane
 Georgia East / FIPS 1001

Depth Ft	Recov	Sample ID	Blow Count	PID (ppm)	Mercury (mg/m3)	USCS Code	Soil Description	Well Construction Diagram
45			7	0.0	0.000	SM	Gray fine to medium SAND, trace silt, wet.	
			13					
46.5			50	0.0	0.000	SM	SAND as above to 46.2 feet, then tan cemented sandstone.	

Well set at 46 ft, ground elevation 8.58 ft.

BORING LOG

Page 1 of 4



Site Name: LCP Chemicals Site, Brunswick GA

Boring No: SW-22

Diameter: 8 in

Date: 07/27/2013

Northing (ft): 431915.78
 Easting (ft): 861615.57
 Elevation (ft): 8.95
 Total Depth: 50.25 Ft

Driller: Groundwater Protection Inc
 Method: Mud Rotary
 Consultant: PARSONS
 Project No: 448517

Datum: NAVD88
 Coordinate System:
 NAD 1983 State Plane
 Georgia East / FIPS 1001

Depth Ft	Recov	Sample ID	Blow Count	PID (ppm)	Mercury (mg/m3)	USCS Code	Soil Description	Well Construction Diagram
0							Hand cleared to 5 ft. Installed with a stick up above ground surface. pH is 7.5.	
5				0.0	0.000			
10							pH is 7.0.	
15				0.0	0.000			

BORING LOG



Site Name: LCP Chemicals Site, Brunswick GA
 Boring No: SW-22
 Diameter: 8 in
 Date: 07/27/2013

Northing (ft): 431915.78
 Easting (ft): 861615.57
 Elevation (ft): 8.95
 Total Depth: 50.25 Ft

Driller: Groundwater Protection Inc
 Method: Mud Rotary
 Consultant: PARSONS
 Project No: 448517

Datum: NAVD88
 Coordinate System:
 NAD 1983 State Plane
 Georgia East / FIPS 1001

Depth Ft	Recov	Sample ID	Blow Count	PID (ppm)	Mercury (mg/m3)	USCS Code	Soil Description	Well Construction Diagram
30							Drilled to 40 ft with mud rotary. No sampling to 40 ft. pH is 7.5	
35				0.0	0.000			
40			7	0.0	0.000	SM	Light gray coarse SAND, 1/4 inch silty clay layers, wet upper 6 inches. Bottom 6 inches, gray medium coarse SAND, little fine sand and silt, wet, no stain or sheen. pH is 7.0 to 7.5.	
			14					
			11					
			10					
			7	0.0	0.000	SM	Same as above, lense of gray clay, little silt, swampy odor.	
			8					
			12					
			11					
			8	0.0	0.000	SP	Gray medium to coarse SAND over fine to medium SAND, over gray brown silt, fine sand, trace shells broken, wet.	
45			9					

BORING LOG



Site Name: LCP Chemicals Site, Brunswick GA
 Boring No: SW-22
 Diameter: 8 in
 Date: 07/27/2013

Northing (ft): 431915.78
 Easting (ft): 861615.57
 Elevation (ft): 8.95
 Total Depth: 50.25 Ft

Driller: Groundwater Protection Inc
 Method: Mud Rotary
 Consultant: PARSONS
 Project No: 448517

Datum: NAVD88
 Coordinate System:
 NAD 1983 State Plane
 Georgia East / FIPS 1001

Depth Ft	Recov	Sample ID	Blow Count	PID (ppm)	Mercury (mg/m3)	USCS Code	Soil Description	Well Construction Diagram
45			11			SP	Gray medium to coarse SAND over fine to medium SAND, over gray brown silt, fine sand, trace shells broken, wet.	
			18					
			8	0.0	0.000		Brown gray fine to medium SAND, little shells broken, trace clay, wet.	
			8			SM		
			21					
			31	0.0	0.000	SM	Gray fine to medium SAND, trace shells, wet.	
			21	0.0	0.000	SM	Gray brown fine to medium SAND, little shells, trace clay, wet.	
			22	0.0	0.000	SM	Gray brown fine to medium SAND, little shells, trace clay, wet.	
				0.0	0.000	SM	Gray brown fine to medium SAND, little shells, trace clay, with little mudstone clasts, wet.	
50 50.25			50/3	0.0	0.000	SM	Sandstone with mudstone clasts in upper, very dense, refusal.	

Well Set at 50 ft.

BORING LOG



Site Name: LCP Chemicals Site, Brunswick GA
 Boring No: SW-23
 Diameter: 8 in
 Date: 07/29/2013

Northing (ft): 431994.55
 Easting (ft): 861615.07
 Elevation (ft): 8.94
 Total Depth: 50.0 Ft

Driller: Groundwater Protection Inc
 Method: Mud Rotary
 Consultant: PARSONS
 Project No: 448517

Datum: NAVD88
 Coordinate System:
 NAD 1983 State Plane
 Georgia East / FIPS 1001

Depth Ft	Recov	Sample ID	Blow Count	PID (ppm)	Mercury (mg/m3)	USCS Code	Soil Description	Well Construction Diagram
30							Volatile organic compounds from rig exhaust. Mud rotary drilling to 40 ft. No sampling to 40 ft. pH is 7.	
35				2.0	0.000			
40			8	0.0	0.000	SM	Gray medium to coarse SAND, little fine sand, wet. pH is 7.	
			12					
			11					
			13					
			7	0.0	0.000	SM	Gray medium to coarse SAND, thin lense of fine sand and silt, little clay, wet.	
			8					
			10					
			12					
			8	0.0	0.000	SM	Gray medium to coarse SAND, bottom 3 inches fine to medium sand, darker gray, wet.	
45			7					

BORING LOG



Site Name: LCP Chemicals Site, Brunswick GA
 Boring No: SW-23
 Diameter: 8 in
 Date: 07/29/2013

Northing (ft): 431994.55
 Easting (ft): 861615.07
 Elevation (ft): 8.94
 Total Depth: 50.0 Ft

Driller: Groundwater Protection Inc
 Method: Mud Rotary
 Consultant: PARSONS
 Project No: 448517

Datum: NAVD88
 Coordinate System:
 NAD 1983 State Plane
 Georgia East / FIPS 1001

Depth Ft	Recov	Sample ID	Blow Count	PID (ppm)	Mercury (mg/m3)	USCS Code	Soil Description	Well Construction Diagram
45			6	0.0	0.000	SM	Gray medium to coarse SAND, bottom 3 inches fine to medium sand, darker gray, wet.	
			7					
			6	0.0	0.000	SM	Same as above, darker gray SAND, bottom 8 inches gray fine SAND and SILT, clay lenses 1/4 inch, trace shells bottom 3 inches.	
			8					
			12	0.0	0.000	SM	Fine SAND, little silt, trace shells, soft, wet. Bottom inch top of rock, sandstone lighter gray, cemented.	
			11					
			12	0.0	0.000	SM		
			17					
			10	0.0	0.000			
50.0			50/5	0.0	0.000			

Well Set at 50 ft.

BORING LOG



Site Name: LCP Chemicals Site, Brunswick GA
 Boring No: SW-24
 Diameter: 8 in
 Date: 08/10/2013 - 08/11/2013

Northing (ft): 431398.89
 Easting (ft): 861681.89
 Elevation (ft): 9.75
 Total Depth: 50.5 Ft

Driller: Groundwater Protection Inc
 Method: Mud Rotary
 Consultant: Mutch Associates
 Project No: 448517

Datum: NAVD88
 Coordinate System:
 NAD 1983 State Plane
 Georgia East / FIPS 1001

Depth Ft	Recov	Sample ID	Blow Count	PID (ppm)	Mercury (mg/m3)	USCS Code	Soil Description	Well Construction Diagram
30							Brown gray drilling mud, pH 7.	
35				19.6	0			
40			7	0	0	SM	Gray fine to coarse SAND, trace silt.	
			9					
			11					
			18			SM	41 ft to 41 ft 4 in Gray fine to coarse SAND, trace silt, 41 ft 4 in to 42 ft Gray fine to medium SAND, some silt.	
			12	0	0	SM	Gray fine to coarse SAND, trace silt.	
			16					
			16			SM	Gray fine to coarse SAND, trace silt.	
			19					
			9	0	0	SM	Gray fine to medium SAND, trace silt.	
45			9					

BORING LOG



Site Name: LCP Chemicals Site, Brunswick GA
 Boring No: SW-24
 Diameter: 8 in
 Date: 08/10/2013 - 08/11/2013

Northing (ft): 431398.89
 Easting (ft): 861681.89
 Elevation (ft): 9.75
 Total Depth: 50.5 Ft

Driller: Groundwater Protection Inc
 Method: Mud Rotary
 Consultant: Mutch Associates
 Project No: 448517

Datum: NAVD88
 Coordinate System:
 NAD 1983 State Plane
 Georgia East / FIPS 1001

Depth Ft	Recov	Sample ID	Blow Count	PID (ppm)	Mercury (mg/m3)	USCS Code	Soil Description	Well Construction Diagram			
45			13	0	0	SM	45 ft to 45 ft 8 in Gray fine to medium SAND, little silt, 45 ft 8 in to 46 ft Gray CLAY and silt, little sand.				
			16			SM	Gray fine to medium SAND, trace silt.				
			12			SC	47 ft to 47 ft 4 in Gray fine to medium SAND, trace silt, 47 ft 4 in to 47 ft 10 in Gray CLAY, stiff, 47 ft 10 in to 48 ft Gray fine to coarse SAND, trace silt.				
			14			SM	Gray fine to medium SAND, little silt.				
			50			22	0		0	SM	49 ft to 49 ft 6 in Gray fine to medium SAND, little silt, 49 ft 6 in to 50 ft Gray fine to coarse SAND, trace silt.
						19				SM/R	Gray fine to coarse SAND, trace silt, cemented sandstone in tip of spoon.
						5					
						7					
						9					
						15					
50.6			50								

Well Set at 50.5 ft. While over drilling the initial pilot hole, a void (likely pipe or tank) was encountered by the 8 in. bit and drained the neck of the mud tub down to 7 ft. bgs. The rig was moved 5 ft. W to avoid the void.

BORING LOG



Site Name: LCP Chemicals Site, Brunswick GA
 Boring No: SW-25
 Diameter: 9 in
 Date: 08/07/2013 - 08/08/2013

Northing (ft): 431475.35
 Easting (ft): 861685.55
 Elevation (ft): 9.85
 Total Depth: 51.0 Ft

Driller: Groundwater Protection Inc
 Method: Mud Rotary
 Consultant: Mutch Associates
 Project No: 448517

Datum: NAVD88
 Coordinate System:
 NAD 1983 State Plane
 Georgia East / FIPS 1001

Depth Ft	Recov	Sample ID	Blow Count	PID (ppm)	Mercury (mg/m3)	USCS Code	Soil Description	Well Construction Diagram
45			17	0	0	SM	Gray fine to medium SAND, little silt.	
			17			SM	Gray fine to medium SAND, trace silt.	
			7			SM	Gray fine to medium SAND, some silt and clay.	
			7			SC	Gray fine to medium SAND, little silt.	
			9	0	0	SM	Gray fine to medium SAND, little silt.	
			8			SM	Gray fine to medium SAND, little silt.	
			4			SM	Gray fine to medium SAND, little silt.	
			6			SM	Gray fine to medium SAND, little silt.	
			8	0	0	SM	Gray fine to medium SAND, little silt.	
			12			SM/R	Gray fine to coarse SAND, little silt, 2 in of weakly cemented sandstone in tip of spoon.	
			7			SM/R	Gray fine to coarse SAND, little silt, 2 in of weakly cemented sandstone in tip of spoon.	
51.0			45					

Well Set at 51 ft.

BORING LOG



Site Name: LCP Chemicals Site, Brunswick GA
 Boring No: SW-26
 Diameter: 8 in
 Date: 07/23/2013

Northing (ft): 431557.34
 Easting (ft): 861686.52
 Elevation (ft): 10.65
 Total Depth: 52.5 Ft

Driller: Groundwater Protection Inc
 Method: Mud Rotary
 Consultant: PARSONS
 Project No: 448517

Datum: NAVD88
 Coordinate System:
 NAD 1983 State Plane
 Georgia East / FIPS 1001

Depth Ft	Recov	Sample ID	Blow Count	PID (ppm)	Mercury (mg/m3)	USCS Code	Soil Description	Well Construction Diagram
30							Mud rotary drilling, mud ph 7.	
35								
40			9			SM	Gray fine to medium SAND, trace silt, wet.	
			11					
			8			SM	Gray fine to medium SAND, trace silt, wet.	
			11					
			4			CL/SW	Gray CLAY to 42.5 feet, then gray medium to coarse SAND, wet.	
			11					
			9			SW	Gray medium to coarse SAND, wet.	
			3					
			7					
45			5					

BORING LOG



Site Name: LCP Chemicals Site, Brunswick GA
 Boring No: SW-26
 Diameter: 8 in
 Date: 07/23/2013

Northing (ft): 431557.34
 Easting (ft): 861686.52
 Elevation (ft): 10.65
 Total Depth: 52.5 Ft

Driller: Groundwater Protection Inc
 Method: Mud Rotary
 Consultant: PARSONS
 Project No: 448517

Datum: NAVD88
 Coordinate System:
 NAD 1983 State Plane
 Georgia East / FIPS 1001

Depth Ft	Recov	Sample ID	Blow Count	PID (ppm)	Mercury (mg/m3)	USCS Code	Soil Description	Well Construction Diagram
45			6					
			8					
			10	0.0	0.000	SW	Gray medium to coarse SAND.	
			4	0.0	0.000	CL/SC	Gray CLAY, soft to 47.4 feet then gray SAND, some clay.	
			5	0.0	0.000	CL	Gray CLAY and shells, very soft.	
			2	0.0	0.000	SM	Gray fine to medium SAND, little silt.	
			3	0.0	0.000	SM	Gray fine to medium SAND, little to some silt, trace shell fragments, trace gravel.	
50			5	0.0	0.000		No Recovery in split spoon.	
			1	0.0	0.000	SM	Gray fine to coarse SAND, trace silt, trace gravel, wet.	
			1	0.0	0.000	SM	Gray fine to coarse SAND, trace silt, trace gravel, wet.	
			50/1	0.0	0.000	SM	Partially lithified fine to coarse SAND, trace gravel, trace silt, dry.	

Set well at 52 ft, ground elevation 10.10 ft.

BORING LOG



Site Name: LCP Chemicals Site, Brunswick GA

Boring No: SW-27

Diameter: 8 in

Date: 07/22/2013 - 07/23/2013

Northing (ft): 431635.01
 Easting (ft): 861685.01
 Elevation (ft): 10.57
 Total Depth: 52.5 Ft

Driller: Groundwater Protection Inc
 Method: Mud Rotary
 Consultant: PARSONS
 Project No: 448517

Datum: NAVD88
 Coordinate System:
 NAD 1983 State Plane
 Georgia East / FIPS 1001

Depth Ft	Recov	Sample ID	Blow Count	PID (ppm)	Mercury (mg/m3)	USCS Code	Soil Description	Well Construction Diagram
30			4	0.0	0.000	SW	Gray coarse to very coarse SAND, trace gravel, wet.	
			8					
			11	0.0	0.000	SM	Black very fine to fine SAND, trace silt, wet.	
			11					
			9	0.0	0.000	SW	Gray coarse to very coarse SAND, trace gravel.	
			10					
			12	0.0	0.000	SM	Black fine to medium SAND, trace silt.	
			14					
			10	0.0	0.000	SW	Gray very coarse to coarse SAND, trace gravel, wet.	
			10					
35			12	0.0	0.000	SM	Gray very fine to medium SAND, wet.	
			13					
			16	0.0	0.000	SW	Gray very coarse SAND, trace silt, wet.	
			14					
			14	0.0	0.000	SM	Gray fine SAND, wet.	
			15					
			14	0.0	0.000	SM	Gray fine SAND, wet.	
			14					
			11	0.0	0.000	SC	Gray fine SAND, little black clay, laminated.	
			12					
40			8	0.0	0.000	SC	Gray coarse SAND, with 3 inch clay lense, wet.	
			7					
			10	0.0	0.000	SM	Gray fine to coarse SAND, wet.	
			14					
			4	0.0	0.000	SM	Gray fine to coarse SAND, wet.	
			4					
			4	0.0	0.000	SW	Gray medium to coarse SAND, wet.	
			7					
45			10	0.0	0.000	SW	Gray coarse to very coarse SAND, wet.	
			10					

BORING LOG



Site Name: LCP Chemicals Site, Brunswick GA
 Boring No: SW-27
 Diameter: 8 in
 Date: 07/22/2013 - 07/23/2013

Northing (ft): 431635.01
 Easting (ft): 861685.01
 Elevation (ft): 10.57
 Total Depth: 52.5 Ft

Driller: Groundwater Protection Inc
 Method: Mud Rotary
 Consultant: PARSONS
 Project No: 448517

Datum: NAVD88
 Coordinate System:
 NAD 1983 State Plane
 Georgia East / FIPS 1001

Depth Ft	Recov	Sample ID	Blow Count	PID (ppm)	Mercury (mg/m3)	USCS Code	Soil Description	Well Construction Diagram
45	No Recovery		7	0.0	0.000	SP	Black very coarse SAND, trace silt.	
			10	0.0	0.000	SP		
			9	0.3	0.000	SW	Gray coarse to very coarse SAND.	
			9	0.3	0.000	SM	Black fine to medium SAND, trace silt, wet.	
			15	0.3	0.000	SM		
			24	0.3	0.000	SM		
			5	0.0	0.000	SW	Gray coarse to very coarse SAND and gravel, wet.	
			8	0.0	0.000	SW		
			9	0.0	0.000	SM	Black fine to medium SAND, little silt.	
			13	0.0	0.000	SM		
50			9	0.0	0.000	SM	Gray fine to medium SAND, little silt, wet.	
			4	0.0	0.000		No Recovery in split spoon.	
			5	0.0	0.000	SM	Gray fine to medium SAND, trace clay.	
			22	0.0	0.000	CL	Clay lenses and shell fragments, dry to moist.	
			40	0.0	0.000	SW	Gray coarse SAND and gravel.	

Well set at 51.5 ft, ground elevation 9.83 ft.

BORING LOG



Site Name: LCP Chemicals Site, Brunswick GA
 Boring No: SW-28
 Diameter: 8 in
 Date: 07/22/2013 - 07/23/2013

Northing (ft): 431715.38
 Easting (ft): 861685.72
 Elevation (ft): 10.27
 Total Depth: 52.5 Ft

Driller: Groundwater Protection Inc
 Method: Mud Rotary
 Consultant: Mutch Associates
 Project No: 448517

Datum: NAVD88
 Coordinate System:
 NAD 1983 State Plane
 Georgia East / FIPS 1001

Depth Ft	Recov	Sample ID	Blow Count	PID (ppm)	Mercury (mg/m3)	USCS Code	Soil Description	Well Construction Diagram
30			7	0	0	SM	Brown fine to medium SAND, some silt.	
			7			SM	Gray fine to coarse SAND, little silt, pH 7.	
			9	0	0	SM	Gray fine to coarse SAND, little silt.	
			5			SM	Gray fine to coarse SAND, little silt.	
			7	0.0	0	SM	Gray fine to coarse SAND, little silt.	
			6			SM	Gray fine to coarse SAND, little silt.	
			12	0.0	0	SM	Gray fine to medium SAND, trace silt.	
			9			SM	Gray fine to medium SAND, some silt.	
35			8	0.0	0	SM	Gray fine to medium SAND, trace silt.	
			13			SM	Brown fine SAND, trace silt.	
			14	0	0	SM	38 ft to 38 ft 6 in in Brown fine SAND, trace silt, 38 ft 6 in to 38 ft 9 in in Gray CLAY, some sand, 38 ft 9 in to 40 ft Gray fine to coarse SAND, trace silt.	
			7			SM	Gray fine to coarse SAND, trace silt.	
			7	0	0	SM	Gray medium to coarse SAND, trace silt.	
			7			SM	Gray fine to coarse SAND, little silt.	
			6	0	0	SM	Gray medium to coarse SAND, trace silt, occasionally 1/2 inch beds medium to coarse sand, little silt.	
			6			SM	Gray medium to coarse SAND, trace silt, occasionally 1/2 inch beds medium to coarse sand, little silt.	
40			15	0	0	SM	Gray medium to coarse SAND, trace silt.	
			12			SM	Gray medium to coarse SAND, trace silt.	
			14	0	0	SM	Gray medium to coarse SAND, trace silt.	
			15			SM	Gray medium to coarse SAND, trace silt.	
			14	0	0	SM	Gray medium to coarse SAND, trace silt.	
			12			SM	Gray medium to coarse SAND, trace silt.	
			14	0	0	SM	Gray medium to coarse SAND, trace silt.	
			15			SM	Gray medium to coarse SAND, trace silt.	
45			5	0	0	SM	Gray medium to coarse SAND, trace silt.	
			6			SM	Gray medium to coarse SAND, trace silt.	

BORING LOG



Site Name: LCP Chemicals Site, Brunswick GA
 Boring No: SW-28
 Diameter: 8 in
 Date: 07/22/2013 - 07/23/2013

Northing (ft): 431715.38
 Easting (ft): 861685.72
 Elevation (ft): 10.27
 Total Depth: 52.5 Ft

Driller: Groundwater Protection Inc
 Method: Mud Rotary
 Consultant: Mutch Associates
 Project No: 448517

Datum: NAVD88
 Coordinate System:
 NAD 1983 State Plane
 Georgia East / FIPS 1001

Depth Ft	Recov	Sample ID	Blow Count	PID (ppm)	Mercury (mg/m3)	USCS Code	Soil Description	Well Construction Diagram
45			6	0	0	SC	45 ft to 45 ft 3 in Gray CLAY stiff, 45 ft 3 in to 46 ft fine to medium SAND, little silt.	
			5			SM	Gray brown fine to coarse SAND, trace silt.	
			5			SM	Gray brown fine to coarse SAND, trace silt.	
			6			SM	Gray fine to medium SAND, little silt, 1/4 inch white shell layers.	
			7			SM	Gray fine to medium SAND, little silt, 1/4 inch white shell layers.	
			33			SM	Gray fine to medium SAND, little silt, 1/4 inch white shell layers.	
			18			SM	Gray fine to medium SAND, little silt, 1/4 inch white shell layers.	
			24			SM	Gray fine to medium SAND, little silt, 1/4 inch white shell layers.	
			25			SM	Gray fine to medium SAND, little silt, 1/4 inch white shell layers.	
			18			SM	Gray fine to medium SAND, little silt, 1/4 inch white shell layers.	
50			16			SM	Gray fine to medium SAND, little silt, 1/4 inch white shell layers.	
			27			SM	51 ft to 51 ft 6 in no recovery, 51 ft 6 in to 52 ft Gray fine to medium SAND, some silt, 1/4 inch white shell layers.	
			16			SM	51 ft to 51 ft 6 in no recovery, 51 ft 6 in to 52 ft Gray fine to medium SAND, some silt, 1/4 inch white shell layers.	
			13			SM/R	52 ft to 52 ft 4 in Gray fine to medium SAND, some silt, 1/4 inch white shells, 52 ft 5 in refusal.	
52.5			50					

Well Set at 51.5 ft.

BORING LOG



Site Name: LCP Chemicals Site, Brunswick GA
 Boring No: SW-29
 Diameter: 8 in
 Date: 07/24/2013

Northing (ft): 431794.84
 Easting (ft): 861685.51
 Elevation (ft): 10.02
 Total Depth: 52.75 Ft

Driller: Groundwater Protection Inc
 Method: Mud Rotary
 Consultant: Mutch Associates
 Project No: 448517

Datum: NAVD88
 Coordinate System:
 NAD 1983 State Plane
 Georgia East / FIPS 1001

Depth Ft	Recov	Sample ID	Blow Count	PID (ppm)	Mercury (mg/m3)	USCS Code	Soil Description	Well Construction Diagram
30							Brown drilling MUD, pH 7 to 8.	
			12	0	0	SM	Brown medium to coarse SAND, trace silt.	
			15			SM	Brown medium to coarse SAND, trace silt.	
			22			SM	Brown medium to coarse SAND, trace silt.	
			23	0	0	SM	Brown medium to coarse SAND, trace silt.	
			11			SM	Brown medium to coarse SAND, trace silt.	
			15			SM	43 ft to 43 ft 3 in Gray CLAY dense, 43 ft 3 in to 44 ft Gray medium to coarse SAND, trace silt, pH 10.	
			16	0.0	0	SM	Gray medium to coarse SAND, trace silt, trace gravel, pH 10.	
			18			SM	Gray medium to coarse SAND, trace silt, trace gravel, pH 10.	
			10			SM	Gray medium to coarse SAND, trace silt, trace gravel, pH 10.	
45			12					

BORING LOG



Site Name: LCP Chemicals Site, Brunswick GA
 Boring No: SW-29
 Diameter: 8 in
 Date: 07/24/2013

Northing (ft): 431794.84
 Easting (ft): 861685.51
 Elevation (ft): 10.02
 Total Depth: 52.75 Ft

Driller: Groundwater Protection Inc
 Method: Mud Rotary
 Consultant: Mutch Associates
 Project No: 448517

Datum: NAVD88
 Coordinate System:
 NAD 1983 State Plane
 Georgia East / FIPS 1001

Depth Ft	Recov	Sample ID	Blow Count	PID (ppm)	Mercury (mg/m3)	USCS Code	Soil Description	Well Construction Diagram
45			13	0.0	0	SM	Gray medium to coarse SAND, trace silt, trace gravel, pH 10.	
			20			SM	Gray fine to medium SAND, trace silt.	
			5			SM	Gray fine to medium SAND, trace silt.	
			6			SM	Gray fine to medium SAND, trace silt.	
			11			SM	Gray fine to medium SAND, trace silt.	
			13			SM	Gray fine to medium SAND, trace silt.	
			8			SC/SM	48 ft to 48 ft 6 in Gray fine to medium SAND, trace silt, clay lenses, 48 ft 6 in to 49 ft Gray fine to medium SAND, trace silt.	
			12			SM	Gray fine to medium SAND, trace silt.	
			15			SM	Gray fine to medium SAND, trace silt.	
			16			SM	Gray fine to medium SAND, trace silt.	
50			1			SC	Gray fine to medium SAND, trace silt, thin clay lenses.	
			1			SM	Gray fine to medium SAND, trace silt.	
			7			SM	Gray fine to medium SAND, trace silt.	
			16			SM	Gray fine to medium SAND, trace silt.	
			35			SM/R	52 ft to 52 ft 6 in Gray fine to medium SAND, little silt, trace white shell fragments, 52 ft 6 in to 52 ft 9 in Gray fine to medium SAND, little silt, weakly cemented sandstone, refusal.	
52.75		50						

Well Set at 52 ft.

BORING LOG



Site Name: LCP Chemicals Site, Brunswick GA
 Boring No: SW-30
 Diameter: 8 in
 Date: 07/25/2013

Northing (ft): 431874.71
 Easting (ft): 861685.50
 Elevation (ft): 9.57
 Total Depth: 52.33 Ft

Driller: Groundwater Protection Inc
 Method: Mud Rotary
 Consultant: Mutch Associates
 Project No: 448517

Datum: NAVD88
 Coordinate System:
 NAD 1983 State Plane
 Georgia East / FIPS 1001

Depth Ft	Recov	Sample ID	Blow Count	PID (ppm)	Mercury (mg/m3)	USCS Code	Soil Description	Well Construction Diagram
30							Brown drilling MUD, pH 7.	
35				0.5				
40			6	0	0	SM	Brown coarse SAND, trace silt.	
			12					
			16					
			18			SM	Gray fine to medium SAND, trace silt.	
			6	0	0	SM	42 ft 6 in to 43 ft Gray fine to medium SAND, trace silt.	
			11					
						CL/SC	43 ft to 43 ft 6 in Gray CLAY, stiff, 43 ft 6 in to 44 ft Gray fine to medium SAND, little silt and clay.	
			27	0	0	SM	Gray fine to medium SAND, trace silt, little white shell fragments.	
45			50					

BORING LOG



Site Name: LCP Chemicals Site, Brunswick GA
 Boring No: SW-30
 Diameter: 8 in
 Date: 07/25/2013

Northing (ft): 431874.71
 Easting (ft): 861685.50
 Elevation (ft): 9.57
 Total Depth: 52.33 Ft

Driller: Groundwater Protection Inc
 Method: Mud Rotary
 Consultant: Mutch Associates
 Project No: 448517

Datum: NAVD88
 Coordinate System:
 NAD 1983 State Plane
 Georgia East / FIPS 1001

Depth Ft	Recov	Sample ID	Blow Count	PID (ppm)	Mercury (mg/m3)	USCS Code	Soil Description	Well Construction Diagram
45							Note Due to refusal of spoon to layer white shells this was drilled through.	
			11	0	0	SM	Gray fine to medium SAND, trace silt, little white shell fragments.	
			17					
			27			SM	Gray fine to medium SAND, trace silt, little white shell fragments.	
			50					
			21	0	0	SM	Gray fine to medium SAND, trace silt, little white shell fragments.	
			34					
			41			SM	Gray fine to medium SAND, trace silt, little white shell fragments.	
			50					
50			13	0	0	SM	Gray fine to medium SAND, trace silt, little white shell fragments.	
			19					
			16			SM	Gray fine to medium SAND, trace silt, little white shell fragments.	
			20					
52.33			50	0	0	SM/R	Black SANDSTONE weakly cemented, some Gray fine to medium sand, trace silt.	

Well Set at 52 ft.

BORING LOG



Site Name: LCP Chemicals Site, Brunswick GA
 Boring No: SW-31
 Diameter: 8 in
 Date: 07/29/2013

Northing (ft): 431954.74
 Easting (ft): 861684.83
 Elevation (ft): 9.27
 Total Depth: 48.8 Ft

Driller: Groundwater Protection Inc
 Method: Mud Rotary
 Consultant: PARSONS
 Project No: 448517

Datum: NAVD88
 Coordinate System:
 NAD 1983 State Plane
 Georgia East / FIPS 1001

Depth Ft	Recov	Sample ID	Blow Count	PID (ppm)	Mercury (mg/m3)	USCS Code	Soil Description	Well Construction Diagram
30							pH is 7.5.	
35				0.000	0.000			
40				0.0	0.000	SM	Gray medium to coarse SAND, little fine sand, wet.	
				0.0	0.000	SM	Gray medium to coarse SAND, little fine sand, wet.	
45				0.0	0.000	SM	Gray medium to coarse SAND, little fine sand, wet.	

BORING LOG



Site Name: LCP Chemicals Site, Brunswick GA
 Boring No: SW-31
 Diameter: 8 in
 Date: 07/29/2013

Northing (ft): 431954.74
 Easting (ft): 861684.83
 Elevation (ft): 9.27
 Total Depth: 48.8 Ft

Driller: Groundwater Protection Inc
 Method: Mud Rotary
 Consultant: PARSONS
 Project No: 448517

Datum: NAVD88
 Coordinate System:
 NAD 1983 State Plane
 Georgia East / FIPS 1001

Depth Ft	Recov	Sample ID	Blow Count	PID (ppm)	Mercury (mg/m3)	USCS Code	Soil Description	Well Construction Diagram
45				0.0	0.000	SM	Gray medium to coarse SAND, little fine sand, wet.	
				0.0	0.000	SM	Gray medium to coarse SAND, little fine sand, wet with thin silty clay lenses at bottom of sample.	
				0.0	0.000	SM	Gray fine to medium SAND, trace coarse sand over gray fine sand, trace shells, wet.	
			50/4			SM	Gray fine to medium SAND, trace coarse sand over gray fine sand, trace shells, wet with pebble size clasts of bedrock.	
49.0						SM		

Well Set at 49 ft.

BORING LOG



Site Name: LCP Chemicals Site, Brunswick GA
 Boring No: SW-32
 Diameter: 8 in
 Date: 07/26/2013

Northing (ft): 432036.94
 Easting (ft): 861683.88
 Elevation (ft): 8.78
 Total Depth: 49.5 Ft

Driller: Groundwater Protection Inc
 Method: Mud Rotary
 Consultant: PARSONS
 Project No: 448517

Datum: NAVD88
 Coordinate System:
 NAD 1983 State Plane
 Georgia East / FIPS 1001

Depth Ft	Recov	Sample ID	Blow Count	PID (ppm)	Mercury (mg/m3)	USCS Code	Soil Description	Well Construction Diagram
15							Drilled from 5 to 40 feet with mud rotary, no sampling. pH is 7.	
20								
25								
30								

BORING LOG



Site Name: LCP Chemicals Site, Brunswick GA

Boring No: SW-32

Diameter: 8 in

Date: 07/26/2013

Northing (ft): 432036.94

Easting (ft): 861683.88

Elevation (ft): 8.78

Total Depth: 49.5 Ft

Driller: Groundwater Protection Inc

Method: Mud Rotary

Consultant: PARSONS

Project No: 448517

Datum: NAVD88

Coordinate System:

NAD 1983 State Plane
Georgia East / FIPS 1001

Depth Ft	Recov	Sample ID	Blow Count	PID (ppm)	Mercury (mg/m3)	USCS Code	Soil Description	Well Construction Diagram
45			7			SM	Top 18 inches same as above, bottom 6 inches dark gray fine to medium SAND, some coarse sand, silty sand, trace clay in end of sample, wet.	
			9					
			6	0.0	0.000			
			6			ML	Gray medium to coarse SAND as above top 4 inches wet, over dark gray medium to coarse SAND, bottom 8 inches dark gray CLAY stiff, little silt, fine to medium sand lenses	
			8					
			13					
			5	0.0	0.00	SM	Brown fine to medium SAND, little shells fragments, wet.	
			3	0.0	0.00	SM	Brown fine to medium SAND, more shells, wet.	
49.5			50/5	0.0	0.00	SM	Brown fine to medium SAND, little shells, trace silt and clay, wet.	

Well Set at 47.5 ft.

BORING LOG



Site Name: LCP Chemicals Site, Brunswick GA
 Boring No: SW-33
 Diameter: 8 in
 Date: 08/08/2013 - 08/09/2013

Northing (ft): 432115.61
 Easting (ft): 861685.36
 Elevation (ft): 8.90
 Total Depth: 49.4 Ft

Driller: Groundwater Protection Inc
 Method: Mud Rotary
 Consultant: PARSONS
 Project No: 448517

Datum: NAVD88
 Coordinate System:
 NAD 1983 State Plane
 Georgia East / FIPS 1001

Depth Ft	Recov	Sample ID	Blow Count	PID (ppm)	Mercury (mg/m3)	USCS Code	Soil Description	Well Construction Diagram
45			19			SM	Sand as above over dark gray medium SAND, trace clay in lenses, wet.	
			21					
			14	0.0	0.000			
			16					
			19			SM	Medium gray fine to medium SAND 7 inches over darker gray fine to medium SAND, trace to little clay in lenses, bottom 2 inches stiff silt and clay, wet.	
			20					
			5	0.0	0.000	SM	Gray fine SAND, wet.	
			6	0.0	0.000	CL	Gray CLAY, trace to little silt, stiff, wet.	
			50/5	0.0	0.000	CL	Clay as above over weathered sandstone, wet.	
49.5								

Well Set at 48 ft.

BORING LOG



Site Name: LCP Chemicals Site, Brunswick GA
 Boring No: SW-34
 Diameter: 8 in
 Date: 08/12/2013

Northing (ft): 432197.50
 Easting (ft): 861689.45
 Elevation (ft): 9.48
 Total Depth: 50.8 Ft

Driller: Groundwater Protection Inc
 Method: Mud Rotary
 Consultant: PARSONS
 Project No: 448517

Datum: NAVD88
 Coordinate System:
 NAD 1983 State Plane
 Georgia East / FIPS 1001

Depth Ft	Recov	Sample ID	Blow Count	PID (ppm)	Mercury (mg/m3)	USCS Code	Soil Description	Well Construction Diagram
30							pH is 7.5.	
35								
40			11	0.0	0.000	SM	Tan and gray medium to coarse SAND, wet.	
			17					
			17					
			19					
			10	0.0	0.000	SM	Tan medium SAND over 4 inches gray coarse medium SAND, wet.	
			13					
			15					
			18					
			3	0.0	0.000	CL	Greenish gray CLAY, semi stiff over 4 inches fine medium sand, some clay.	
45			3					

BORING LOG



Site Name: LCP Chemicals Site, Brunswick GA
 Boring No: SW-34
 Diameter: 8 in
 Date: 08/12/2013

Northing (ft): 432197.50
 Easting (ft): 861689.45
 Elevation (ft): 9.48
 Total Depth: 50.8 Ft

Driller: Groundwater Protection Inc
 Method: Mud Rotary
 Consultant: PARSONS
 Project No: 448517

Datum: NAVD88
 Coordinate System:
 NAD 1983 State Plane
 Georgia East / FIPS 1001

Depth Ft	Recov	Sample ID	Blow Count	PID (ppm)	Mercury (mg/m3)	USCS Code	Soil Description	Well Construction Diagram	
45			5	0.0	0.000	CL	Greenish gray CLAY, semi stiff over 4 inches fine medium sand, some clay.		
			7			CL	Clay as above 4 inches over fine to medium SAND, little clay in lenses 4 inches over more clay, thin lenses of fine sand scattered.		
			7						
				12	0.0	0.000	SM		Fine medium SAND, trace shells, some clay upper 4 inches, wet. Greenish gray clay with thin lenses of fine sand bottom 4 inches.
				13					
				12					
				12	0.0	0.000			Same as bottom of last sample, trace weathered sandstone in bottom.
				15					
				12	0.0	0.000			Gray weathered sandstone, trace quartz, pebbles, broken sandstone.
				8					
50				11	0.0	0.000			
50.8				50/4	0.0	0.000			

Well Set at 44 ft.

BORING LOG



Site Name: LCP Chemicals Site, Brunswick GA
 Boring No: SW-35
 Diameter: 8 in
 Date: 08/09/2013 - 08/11/2013

Northing (ft): 432274.82
 Easting (ft): 861685.16
 Elevation (ft): 9.00
 Total Depth: 51.5 Ft

Driller: Groundwater Protection Inc
 Method: Mud Rotary
 Consultant: PARSONS
 Project No: 448517

Datum: NAVD88
 Coordinate System:
 NAD 1983 State Plane
 Georgia East / FIPS 1001

Depth Ft	Recov	Sample ID	Blow Count	PID (ppm)	Mercury (mg/m3)	USCS Code	Soil Description	Well Construction Diagram
30							pH is 7.	
35								
40			10	0.0	0.000	SM	Medium gray medium to coarse SAND, trace clay in thin lenses, scattered, wet.	
			15					
			20					
			22					
			5	0.0	0.000	SM	Tan medium to coarse SAND, wet.	
			6					
			25					
			11					
			8					
45			10			CL	Greenish gray CLAY, trace sand in thin lenses, semi stiff, wet, bottom 4 inches fine medium sand, trace clay in thin lense.	

BORING LOG



Site Name: LCP Chemicals Site, Brunswick GA
 Boring No: SW-35
 Diameter: 8 in
 Date: 08/09/2013 - 08/11/2013

Northing (ft): 432274.82
 Easting (ft): 861685.16
 Elevation (ft): 9.00
 Total Depth: 51.5 Ft

Driller: Groundwater Protection Inc
 Method: Mud Rotary
 Consultant: PARSONS
 Project No: 448517

Datum: NAVD88
 Coordinate System:
 NAD 1983 State Plane
 Georgia East / FIPS 1001

Depth Ft	Recov	Sample ID	Blow Count	PID (ppm)	Mercury (mg/m3)	USCS Code	Soil Description	Well Construction Diagram			
45	[RECOVERED]		14	0.0	0.000	CL	Greenish gray CLAY, trace sand in thin lenses, semi stiff, wet, bottom 4 inches fine medium sand, trace clay in thin lense.	[RECOVERED]			
			12								
			5			CL/SM	Clay 7 inches over fine to medium SAND 10 inches, over gray clay, trace sand in lenses 7 inches, semi stiff, wet.				
			14								
			10								
			10								
			50			5	0.0		0.000	CL	Greenish gray CLAY, trace sand 3 inch lense, over more clay, bottom 2 inches fine medium sand, trace shells, wet.
						10					
						11					
						10	Weathered sandstone, hard.				
						1					
						1					
			51.5			50/3					

Well Set at 44 ft.

BORING LOG



Site Name: LCP Chemicals Site, Brunswick GA
 Boring No: SW-36
 Diameter: 8 in
 Date: 08/10/2013

Northing (ft): 431431.32
 Easting (ft): 861751.31
 Elevation (ft): 9.74
 Total Depth: 50.5 Ft

Driller: Groundwater Protection Inc
 Method: Mud Rotary
 Consultant: Mutch Associates
 Project No: 448517

Datum: NAVD88
 Coordinate System:
 NAD 1983 State Plane
 Georgia East / FIPS 1001

Depth Ft	Recov	Sample ID	Blow Count	PID (ppm)	Mercury (mg/m3)	USCS Code	Soil Description	Well Construction Diagram
30							Brown gray drilling MUD, pH 7.	
35				0	0			
40			5	0	0	SC	Gray fine to coarse SAND, trace silt, two 1 inch layers of silty clay.	
			8					
			11			SM	Gray fine to coarse SAND, trace silt.	
			15					
			11	0	0	SM	Gray fine to coarse SAND, trace silt.	
			12					
			11			SM	Gray fine to coarse SAND, trace silt.	
			11					
			15	0	0		No recovery, rock blocked front of spoon.	
45			13					

BORING LOG



Site Name: LCP Chemicals Site, Brunswick GA
 Boring No: SW-36
 Diameter: 8 in
 Date: 08/10/2013

Northing (ft): 431431.32
 Easting (ft): 861751.31
 Elevation (ft): 9.74
 Total Depth: 50.5 Ft

Driller: Groundwater Protection Inc
 Method: Mud Rotary
 Consultant: Mutch Associates
 Project No: 448517

Datum: NAVD88
 Coordinate System:
 NAD 1983 State Plane
 Georgia East / FIPS 1001

Depth Ft	Recov	Sample ID	Blow Count	PID (ppm)	Mercury (mg/m3)	USCS Code	Soil Description	Well Construction Diagram
45			12				No recovery, rock blocked front of spoon.	
			16					
			3	0	0	SC	46 ft to 46 ft 2 in Gray fine to medium SAND, 46 ft 2 in to 46 ft 8 in Gray silty CLAY, 46 ft 8 in to 47 ft Gray fine to coarse SAND, trace silt.	
			9					
			13			SC	Gray fine to coarse SAND, trace silt, occasional lens silt and clay.	
			13					
			11	0	0	SC	Gray fine to coarse SAND, trace silt, occasional lens silt and clay.	
			10					
			13			SC	Gray fine to medium SAND, some clayey silt, trace white shell fragments.	
			20					
50			50			SM/R	50 ft to 50 ft 6 in Gray fine to coarse SAND, little silt, cemented sandstone in tip of spoon.	
50.5								

Well Set at 49 ft.

BORING LOG



Site Name: LCP Chemicals Site, Brunswick GA

Boring No: SW-37

Diameter: 8 in

Date: 08/09/2013

Northing (ft): 431514.59
 Easting (ft): 861752.65
 Elevation (ft): 10.05
 Total Depth: 51.25 Ft

Driller: Groundwater Protection Inc
 Method: Mud Rotary
 Consultant: Mutch Associates
 Project No: 448517

Datum: NAVD88
 Coordinate System:
 NAD 1983 State Plane
 Georgia East / FIPS 1001

Depth Ft	Recov	Sample ID	Blow Count	PID (ppm)	Mercury (mg/m3)	USCS Code	Soil Description	Well Construction Diagram
30							Brown gray drilling MUD, pH 7 to 8.	
35				0	0			
40			4	0	0	SC	Gray fine to coarse SAND, trace silt, occasional lens clay and silt.	
			5					
			8			SC	Gray fine to coarse SAND, trace silt, occasional lens clay and silt.	
			8					
			5	0	0	SM	Gray fine to coarse SAND, trace silt.	
			6					
			9					
			12			SC	Gray fine to coarse SAND, trace silt, 2 inch layer of silty clay.	
			6					
45			13	0	0	SM	Gray fine to coarse SAND, trace silt.	

BORING LOG



Site Name: LCP Chemicals Site, Brunswick GA
 Boring No: SW-37
 Diameter: 8 in
 Date: 08/09/2013

Northing (ft): 431514.59
 Easting (ft): 861752.65
 Elevation (ft): 10.05
 Total Depth: 51.25 Ft

Driller: Groundwater Protection Inc
 Method: Mud Rotary
 Consultant: Mutch Associates
 Project No: 448517

Datum: NAVD88
 Coordinate System:
 NAD 1983 State Plane
 Georgia East / FIPS 1001

Depth Ft	Recov	Sample ID	Blow Count	PID (ppm)	Mercury (mg/m3)	USCS Code	Soil Description	Well Construction Diagram
45			12	0	0	SM	Gray fine to coarse SAND, trace silt.	
			14			SM	Gray fine to medium SAND, trace silt.	
			8			SM	Gray fine to medium SAND, trace silt.	
			12			SM	Gray fine to medium SAND, trace silt.	
			9	0	0	SM	Gray fine to medium SAND, trace silt.	
			11			SM	Gray fine to medium SAND, trace silt.	
			5			SM	Gray fine to medium SAND, trace silt.	
			5			SM	Gray fine to medium SAND, trace silt.	
			11	0	0	SM	Gray fine to medium SAND, trace silt.	
			15			SM	Gray fine to medium SAND, trace silt.	
50			5			SM	50 ft to 50 ft 6 in Gray fine to medium SAND, trace silt, 50 ft 6 in to 51 ft Gray, fine to coarse SAND, little silt.	
			5	0	0	SM	Gray fine to medium SAND, trace silt.	
			50			SM/R	Gray fine to medium SAND, little silt, cemented sandstone in tip of spoon.	
51.25				Well Set at 51 ft.				

BORING LOG



Site Name: LCP Chemicals Site, Brunswick GA
 Boring No: SW-38
 Diameter: 8 in
 Date: 08/10/2013

Northing (ft): 431594.67
 Easting (ft): 861754.38
 Elevation (ft): 10.26
 Total Depth: 51.5 Ft

Driller: Groundwater Protection Inc
 Method: Mud Rotary
 Consultant: Mutch Associates
 Project No: 448517

Datum: NAVD88
 Coordinate System:
 NAD 1983 State Plane
 Georgia East / FIPS 1001

Depth Ft	Recov	Sample ID	Blow Count	PID (ppm)	Mercury (mg/m3)	USCS Code	Soil Description	Well Construction Diagram
30							Brown gray drilling MUD, pH 7.	
35				0	0			
40			11	0	0	SM	Gray fine to coarse SAND, trace silt.	
			15					
			17					
			17			SM	Gray fine to coarse SAND, trace silt.	
			9	0	0	SM	Gray fine to coarse SAND, trace silt.	
			11					
			14					
			16			SM	Gray fine to coarse SAND, trace silt.	
			9					
			13	0	0	SM	Gray fine to coarse SAND, trace silt.	
45								

BORING LOG



Site Name: LCP Chemicals Site, Brunswick GA
 Boring No: SW-38
 Diameter: 8 in
 Date: 08/10/2013

Northing (ft): 431594.67
 Easting (ft): 861754.38
 Elevation (ft): 10.26
 Total Depth: 51.5 Ft

Driller: Groundwater Protection Inc
 Method: Mud Rotary
 Consultant: Mutch Associates
 Project No: 448517

Datum: NAVD88
 Coordinate System:
 NAD 1983 State Plane
 Georgia East / FIPS 1001

Depth Ft	Recov	Sample ID	Blow Count	PID (ppm)	Mercury (mg/m3)	USCS Code	Soil Description	Well Construction Diagram
45			26	0	0	SM	Gray fine to coarse SAND, trace silt.	
			22			SM	Gray fine to medium SAND, trace silt.	
			7			SM	Gray fine to medium SAND, trace silt.	
			7			SM	Gray fine to medium SAND, trace silt.	
			9	0	0	SM	Gray fine to medium SAND, trace silt.	
			13			SM	Gray fine to medium SAND, trace silt.	
			9			SM	Gray fine to medium SAND, trace silt.	
			12			SM	Gray fine to medium SAND, trace silt.	
			16			SM	Gray fine to medium SAND, trace silt.	
			18	0	0	SM	50 ft to 50 ft 6 in Gray fine to medium SAND, trace silt, 50 ft 6 in to 51 ft Gray, fine to coarse SAND, little silt.	
50			7			SM	Gray fine to medium SAND, some silt, cemented sandstone in tip of spoon.	
			7			SM/R	Gray fine to medium SAND, some silt, cemented sandstone in tip of spoon.	
51.5			50					

Well Set at 50.5 ft.

BORING LOG



Site Name: LCP Chemicals Site, Brunswick GA
 Boring No: SW-39
 Diameter: 8 in
 Date: 07/24/2013

Northing (ft): 431754.86
 Easting (ft): 861753.89
 Elevation (ft): 10.43
 Total Depth: 52.92 Ft

Driller: Groundwater Protection Inc
 Method: Mud Rotary
 Consultant: Mutch Associates
 Project No: 448517

Datum: NAVD88
 Coordinate System:
 NAD 1983 State Plane
 Georgia East / FIPS 1001

Depth Ft	Recov	Sample ID	Blow Count	PID (ppm)	Mercury (mg/m3)	USCS Code	Soil Description	Well Construction Diagram
30							Brown drilling MUD, pH 7 to 8.	
35				0.5				
40			12	0	0	SM	Gray medium to coarse SAND, trace silt.	
			14					
			18					
			16					
			12	0	0	SM	Dark Gray fine to medium SAND, trace silt.	
			11					
			19					
			19					
45			7	0	0	SM	44 ft to 44 ft 5 in Gray fine to medium SAND, trace silt, 44 ft 5 in to 44 ft 8 in Gray fine to medium SAND, trace silt, lenses clay, 44 ft 8 in to 45 ft Gray silty CLAY.	
			7					

BORING LOG



Site Name: LCP Chemicals Site, Brunswick GA
 Boring No: SW-39
 Diameter: 8 in
 Date: 07/24/2013

Northing (ft): 431754.86
 Easting (ft): 861753.89
 Elevation (ft): 10.43
 Total Depth: 52.92 Ft

Driller: Groundwater Protection Inc
 Method: Mud Rotary
 Consultant: Mutch Associates
 Project No: 448517

Datum: NAVD88
 Coordinate System:
 NAD 1983 State Plane
 Georgia East / FIPS 1001

Depth Ft	Recov	Sample ID	Blow Count	PID (ppm)	Mercury (mg/m3)	USCS Code	Soil Description	Well Construction Diagram		
45	[Diagram showing recovery status]		8	0	0	SC	Gray fine to medium SAND, little silt, occasional lens clay.	[Well Construction Diagram]		
			13							
			1						SM	Gray fine to medium SAND, some silt.
			2							
			4			SM	Gray fine to medium SAND, trace silt.			
			8							
			5		0	0	GM		48 ft to 48 ft 6 in Gray fine GRAVEL, trace sand, trace silt, 48 ft 6 in to 49 ft Gray fine to medium SAND, trace salt.	
			7							
			11			SM	Gray fine to medium SAND, trace silt.			
			14							
50			4		0	0	SM		Gray fine to medium SAND, trace silt.	
			8							
			9			SM	Gray fine to medium SAND, trace silt, trace white shell fragments, note from 51 ft 6 in to 52 ft trace silt.			
			11							
			12							
52.92		50		0	0	SM	52 ft to 52 ft 6 in Gray fine to medium SAND, little silt, 1/4 inch white shell fragments, 52 ft 6 in to 52 ft 11 in Gray fine to medium SAND, little silt, occasional medium gravel, refusal.			

Well Set at 51.5 ft.

BORING LOG



Site Name: LCP Chemicals Site, Brunswick GA
 Boring No: SW-40
 Diameter: 8 in
 Date: 07/25/2013

Northing (ft): 431835.00
 Easting (ft): 861754.21
 Elevation (ft): 10.50
 Total Depth: 52.33 Ft

Driller: Groundwater Protection Inc
 Method: Mud Rotary
 Consultant: Mutch Associates
 Project No: 448517

Datum: NAVD88
 Coordinate System:
 NAD 1983 State Plane
 Georgia East / FIPS 1001

Depth Ft	Recov	Sample ID	Blow Count	PID (ppm)	Mercury (mg/m3)	USCS Code	Soil Description	Well Construction Diagram
30							Brown drilling MUD, pH 7 to 8.	
35				0.5				
40			12	0	0	SM	Gray fine to coarse SAND, trace silt.	
			15					
			22			SM	Dark Gray medium to fine SAND, trace silt.	
			20					
			14	0	0	SM	Gray brown medium to coarse SAND, trace silt.	
			20					
			27			SM	Gray fine to coarse SAND, trace silt.	
			31					
			12	0	0	SC	44 ft to 44 ft 6 in Gray brown medium coarse SAND, trace silt, 44 ft 6 in to 45 ft Gray fine to coarse SAND, trace silt, occasional lens clay.	
45			18					

BORING LOG



Site Name: LCP Chemicals Site, Brunswick GA
 Boring No: SW-40
 Diameter: 8 in
 Date: 07/25/2013

Northing (ft): 431835.00
 Easting (ft): 861754.21
 Elevation (ft): 10.50
 Total Depth: 52.33 Ft

Driller: Groundwater Protection Inc
 Method: Mud Rotary
 Consultant: Mutch Associates
 Project No: 448517

Datum: NAVD88
 Coordinate System:
 NAD 1983 State Plane
 Georgia East / FIPS 1001

Depth Ft	Recov	Sample ID	Blow Count	PID (ppm)	Mercury (mg/m3)	USCS Code	Soil Description	Well Construction Diagram
45			17	0	0	SC	45 ft to 45 ft 4 in Gray fine to coarse SAND, trace silt, occasional lens clay, 45 ft 4 in to 45 ft 8 in Gray CLAY, stiff, 45 ft 8 in to 46 ft Gray fine to medium SAND, some clayey silt.	
		18						
		13						
		19						
		22			SM	Gray brown fine to medium SAND, little silt.		
		23			SM	Gray fine to coarse SAND, little silt.		
		4		0	0	SM	49 ft to 49 ft 4 in Gray fine to medium SAND, trace silt, pH 10, 49 ft 4 in to 50 ft Gray fine to medium SAND, trace silt, trace white shell fragments.	
		6						
		13				SM	Gray fine to medium SAND, trace silt, trace white shell fragments.	
50		27		0	0	SM	Gray fine to medium SAND, trace silt, trace white shell fragments.	
		33						
		23						
		17				SM	Gray fine to medium SAND, trace silt, trace white shell fragments.	
		12				SM/R	Black SANDSTONE weakly cemented, some Gray fine to medium sand, trace silt.	
52.33			50	0	0	SM/R	Black SANDSTONE weakly cemented, some Gray fine to medium sand, trace silt.	

Well Set at 52 ft.

BORING LOG



Site Name: LCP Chemicals Site, Brunswick GA
 Boring No: SW-41
 Diameter: 8 in
 Date: 07/28/2013

Northing (ft): 431915.25
 Easting (ft): 861754.85
 Elevation (ft): 9.99
 Total Depth: 51.4 Ft

Driller: Groundwater Protection Inc
 Method: Mud Rotary
 Consultant: PARSONS
 Project No: 448517

Datum: NAVD88
 Coordinate System:
 NAD 1983 State Plane
 Georgia East / FIPS 1001

Depth Ft	Recov	Sample ID	Blow Count	PID (ppm)	Mercury (mg/m3)	USCS Code	Soil Description	Well Construction Diagram
45			7			CL	Greenish gray CLAY, lenses of fine to medium sand 1/2-1 inch, little silt in clay, soft, wet.	
			8					
			3	0.0	0.000			
			7			SM	Fine to medium SAND, trace silt over fine sand, little clay, trace shells, low yield, wet.	
			12					
			10					
			9	0.0	0.000		Fine to medium SAND, trace silt, trace shells, no clay, wet, mud pH 7.5-8.	
			8			SM		
			8					
			14					
50			15	0.0	0.000	SM	Fine to medium SAND, trace silt, trace shells, no clay, wet, mud.	
			14	0.0	0.007			
51.5			50/5	0.0	0.000	SM	Fine to medium SAND, trace silt, trace shells, no clay, wet, mud, sandstone pebbles in sample, hard, refusal on bottom.	

Well Set at 51.5 ft.

BORING LOG



Site Name: LCP Chemicals Site, Brunswick GA

Boring No: SW-42

Diameter: 8 in

Date: 07/26/2013

Northing (ft): 431998.47
 Easting (ft): 861755.04
 Elevation (ft): 9.87
 Total Depth: 51.75 Ft

Driller: Groundwater Protection Inc
 Method: Mud Rotary
 Consultant: Mutch Associates
 Project No: 448517

Datum: NAVD88
 Coordinate System:
 NAD 1983 State Plane
 Georgia East / FIPS 1001

Depth Ft	Recov	Sample ID	Blow Count	PID (ppm)	Mercury (mg/m3)	USCS Code	Soil Description	Well Construction Diagram
30							Brown drilling MUD, pH 7 to 8.	
35				542	0			
40			14	0	0	SM	40 ft 6 in to 41 ft Gray fine to coarse SAND, trace silt.	
			14			SM	Gray fine to coarse SAND, trace silt.	
			16					
			16					
			8	0	0	SC	Gray fine to coarse SAND, trace silt, occasional layer fine to medium sand, occasional lens clay, pH 10 to 11.	
			12					
			14			SC	Gray fine to coarse SAND, trace silt, occasional layer fine to medium sand, occasional lens clay, pH 10 to 11.	
			16					
45			6					
			9	0	0	SC	44 ft to 44 ft 6 in Gray fine to coarse SAND, trace silt, 44 ft 6 in to 45 ft Gray CLAY and silt, occasional layer clay and sand.	

BORING LOG



Site Name: LCP Chemicals Site, Brunswick GA
 Boring No: SW-42
 Diameter: 8 in
 Date: 07/26/2013

Northing (ft): 431998.47
 Easting (ft): 861755.04
 Elevation (ft): 9.87
 Total Depth: 51.75 Ft

Driller: Groundwater Protection Inc
 Method: Mud Rotary
 Consultant: Mutch Associates
 Project No: 448517

Datum: NAVD88
 Coordinate System:
 NAD 1983 State Plane
 Georgia East / FIPS 1001

Depth Ft	Recov	Sample ID	Blow Count	PID (ppm)	Mercury (mg/m3)	USCS Code	Soil Description	Well Construction Diagram	
45	[RECOVERED]		12	0	0	CL	Gray CLAY and silt, medium plasticity, occasional layer clay and sand.	[Well Construction Diagram]	
			13			SM	Gray fine to medium SAND, trace silt.		
			16				Gray clayey SILT, trace sand, trace white shell fragments.		
			20				SC		Gray fine to coarse SAND, some silty clay, little white shell fragments, brown sheen.
			48						Gray fine to coarse SAND, some silty clay, little white shell fragments, brown sheen.
			23	SC	50 ft to 50 ft 6 in Gray clayey SILT, trace sand, trace white shell fragments, wet, 50 ft 6 in to 51 ft fine to medium SAND, little silt, trace white shell fragments.				
			12		SC	51 ft to 51 ft 6 in fine to medium SAND, little silt, trace white shell fragments.			
			17			SM/R	51 ft to 51 ft 6 in fine to medium SAND, little silt, mudstone in tip, 51 ft 6 in to 51 ft 8 in bouncing spoon mudstone in tip.		
			20						
			19						
50			8						
			27						
			17						
51.75									

Well Set at 51.5 ft.

BORING LOG



Site Name: LCP Chemicals Site, Brunswick GA
 Boring No: SW-43
 Diameter: 8 in
 Date: 07/29/2013

Northing (ft): 432075.11
 Easting (ft): 861755.08
 Elevation (ft): 9.18
 Total Depth: 50.33 Ft

Driller: Groundwater Protection Inc
 Method: Mud Rotary
 Consultant: Mutch Associates
 Project No: 448517

Datum: NAVD88
 Coordinate System:
 NAD 1983 State Plane
 Georgia East / FIPS 1001

Depth Ft	Recov	Sample ID	Blow Count	PID (ppm)	Mercury (mg/m3)	USCS Code	Soil Description	Well Construction Diagram
30							Brown drilling MUD, pH 8 to 9.	
35				17	0			
40			7	0	0	SC	Gray brown fine to coarse SAND, trace silt, occasional lens clay.	
			9					
			11			SC	Gray brown fine to coarse SAND, trace silt, occasional lens clay.	
			14					
			8	0	0	SC	Gray brown fine to coarse SAND, trace silt, occasional lens clay.	
			10					
			11			SM	Gray fine to coarse SAND, trace silt.	
			13					
			7	0	0	SM	Gray brown fine to medium SAND, trace silt, occasional lens clay.	
45			10					

BORING LOG



Site Name: LCP Chemicals Site, Brunswick GA
 Boring No: SW-43
 Diameter: 8 in
 Date: 07/29/2013

Northing (ft): 432075.11
 Easting (ft): 861755.08
 Elevation (ft): 9.18
 Total Depth: 50.33 Ft

Driller: Groundwater Protection Inc
 Method: Mud Rotary
 Consultant: Mutch Associates
 Project No: 448517

Datum: NAVD88
 Coordinate System:
 NAD 1983 State Plane
 Georgia East / FIPS 1001

Depth Ft	Recov	Sample ID	Blow Count	PID (ppm)	Mercury (mg/m3)	USCS Code	Soil Description	Well Construction Diagram		
45			9	0	0	SM/SC	Gray fine to coarse SAND, trace silt, 2 inch layer of Gray clay.			
			12							
			8						SM	Gray fine to coarse SAND, trace silt.
			12							
			27			SC	Gray fine to medium SAND, lenses Gray clay, odor sulfur like.			
			28							
			6		0	0	CL		Gray CLAY and silt, stiff, 3 layers 1/4 inch Gray fine to coarse sand.	
			5							
			8			CL	Gray CLAY and silt, stiff, 3 layers 1/4 inch Gray fine to coarse sand.			
			7							
50			50	0	0	CL	Gray CLAY, drove 3 inches on 15 blows, then over 35 blows for 1 inch, refusal.			
50.33										

Well Set at 48 ft.

BORING LOG

Site Name: LCP Chemicals Site, Brunswick GA



Boring No: SW-44

Diameter: 8 in

Date: 07/31/2013

Northing (ft): 432155.21
 Easting (ft): 861752.75
 Elevation (ft): 9.48
 Total Depth: 52.0 Ft

Driller: Groundwater Protection Inc
 Method: Mud Rotary
 Consultant: PARSONS
 Project No: 448517

Datum: NAVD88
 Coordinate System:
 NAD 1983 State Plane
 Georgia East / FIPS 1001

Depth Ft	Recov	Sample ID	Blow Count	PID (ppm)	Mercury (mg/m3)	USCS Code	Soil Description	Well Construction Diagram
0							Hand cleared to 5 feet, up to 75 ppm on PID in hole. Installed with a stick up above ground surface. Fluctuating in breathing zone 0.5 to 3.	
5				75			Mud rotary 5-40 feet, no samples. pH is 7.	
10				3	0.000			
15				3	0.000			

BORING LOG

Site Name: LCP Chemicals Site, Brunswick GA
 Boring No: SW-44
 Diameter: 8 in
 Date: 07/31/2013



Northing (ft): 432155.21
 Easting (ft): 861752.75
 Elevation (ft): 9.48
 Total Depth: 52.0 Ft

Driller: Groundwater Protection Inc
 Method: Mud Rotary
 Consultant: PARSONS
 Project No: 448517

Datum: NAVD88
 Coordinate System:
 NAD 1983 State Plane
 Georgia East / FIPS 1001

Depth Ft	Recov	Sample ID	Blow Count	PID (ppm)	Mercury (mg/m3)	USCS Code	Soil Description	Well Construction Diagram
45	[Pattern]		5	0.0	0.000	SM	Greenish gray fine to medium SAND, 1 inch clay lense over dense fine sand, little silt, trace shells, wet.	[Well Construction Diagram]
			10			SM/CL		
	[Pattern]		6	0.0	0.000	ML	SAND as above upper 10 inches over greenish gray CLAY, some to little silt, trace shells in lenses, trace fine sand in lenses.	
			9					
	[Pattern]		16	0.0	0.000	CL	Gray SILT and fine SAND, little clay, clay lenses, wet.	
			12					
	[Pattern]		6	0.0	0.000	CL	Greenish gray CLAY, little silt, trace shells, silt in thin lenses, bottom 6 inches all clay, med stiff.	
			8					
50	[Pattern]		7	0.0	0.000	CL	Gray fine to medium SAND, some silt, little coarse sand, gravel, bedrock pebbles, wet. Hard refusal at 52 feet.	
			9					
	[Pattern]		3	0.0	0.000			
			3					
	[Pattern]		4	0.0	0.000			
			4					
52.0	[Pattern]		50/6	0.0	0.000			

Well Set at 48 ft.

BORING LOG



Site Name: LCP Chemicals Site, Brunswick GA
 Boring No: SW-45
 Diameter: 8 in
 Date: 08/09/2013 - 08/11/2013

Northing (ft): 432237.41
 Easting (ft): 861751.45
 Elevation (ft): 9.12
 Total Depth: 50.4 Ft

Driller: Groundwater Protection Inc
 Method: Mud Rotary
 Consultant: PARSONS
 Project No: 448517

Datum: NAVD88
 Coordinate System:
 NAD 1983 State Plane
 Georgia East / FIPS 1001

Depth Ft	Recov	Sample ID	Blow Count	PID (ppm)	Mercury (mg/m3)	USCS Code	Soil Description	Well Construction Diagram
30								
35				0.0	0.000			
40			10	0.0	0.000	SM	Light gray medium SAND, over coarse sand, over medium sand, wet.	
			16					
			21					
			23					
			6	0.0	0.000	SM	SAND as above, trace clay in thin lense near bottom of sample, greenish gray clay in shoe, wet.	
			13					
			15					
			19					
			5	0.0	0.000	CL	Greenish gray CLAY, some silt in bottom 4 inches, stiff, moist.	
45			7					

BORING LOG



Site Name: LCP Chemicals Site, Brunswick GA
 Boring No: SW-45
 Diameter: 8 in
 Date: 08/09/2013 - 08/11/2013

Northing (ft): 432237.41
 Easting (ft): 861751.45
 Elevation (ft): 9.12
 Total Depth: 50.4 Ft

Driller: Groundwater Protection Inc
 Method: Mud Rotary
 Consultant: PARSONS
 Project No: 448517

Datum: NAVD88
 Coordinate System:
 NAD 1983 State Plane
 Georgia East / FIPS 1001

Depth Ft	Recov	Sample ID	Blow Count	PID (ppm)	Mercury (mg/m3)	USCS Code	Soil Description	Well Construction Diagram	
45			7	0.0	0.000	CL	Greenish gray CLAY, some silt in bottom 4 inches, stiff, moist.		
			10			SM/CL	CLAY 2 inches as above over fine coarse SAND 10 inches, trace small shells, over dark gray silt and clay with thin interbedded sand layers.		
			10						
			19						
			18						
			13	0.0	0.000	CL	Greenish gray CLAY, trace sand in thin layers, scattered.		
			3						
			3						
			5	0.0	0.000		Gray weathered sandstone bedrock, wet. Hard refusal, pieces of broken rock in lower sample.		
			10						
50				50/5	0.0	0.000			

Well Set at 44 ft.

BORING LOG



Site Name: LCP Chemicals Site, Brunswick GA
 Boring No: SW-46
 Diameter: 8 in
 Date: 08/06/2013 - 08/07/2013

Northing (ft): 432322.48
 Easting (ft): 861757.45
 Elevation (ft): 8.65
 Total Depth: 52.0 Ft

Driller: Groundwater Protection Inc
 Method: Mud Rotary
 Consultant: PARSONS
 Project No: 448517

Datum: NAVD88
 Coordinate System:
 NAD 1983 State Plane
 Georgia East / FIPS 1001

Depth Ft	Recov	Sample ID	Blow Count	PID (ppm)	Mercury (mg/m3)	USCS Code	Soil Description	Well Construction Diagram
30							pH is 7.	
35				0.0	0.000			
40			12	0.0	0.000	SM	Gray medium to coarse SAND, trace clay in lense at bottom of sample, wet.	
			15					
			11					
			12					
			4	0.0	0.000	SM/CL	Gray SAND as above grading to fine to medium sand, layer of silty clay near bottom 5 inches, bottom fine sand, wet.	
			9					
			19					
			16					
45			18	0.0	0.000	SM/CL	Tan gray SAND, over 8 inches of greenish gray CLAY, semi stiff, wet.	
			18					

BORING LOG



Site Name: LCP Chemicals Site, Brunswick GA
 Boring No: SW-46
 Diameter: 8 in
 Date: 08/06/2013 - 08/07/2013

Northing (ft): 432322.48
 Easting (ft): 861757.45
 Elevation (ft): 8.65
 Total Depth: 52.0 Ft

Driller: Groundwater Protection Inc
 Method: Mud Rotary
 Consultant: PARSONS
 Project No: 448517

Datum: NAVD88
 Coordinate System:
 NAD 1983 State Plane
 Georgia East / FIPS 1001

Depth Ft	Recov	Sample ID	Blow Count	PID (ppm)	Mercury (mg/m3)	USCS Code	Soil Description	Well Construction Diagram			
45			17	0.0	0.000	SM/CL	Tan gray SAND, over 8 inches of greenish gray CLAY, semi stiff, wet.				
			15			SM/CL					
			12								
			9	0.0	0.000	CL	Greenish gray CLAY, scattered thin sand lenses, semi stiff, moist.				
			11								
			10								
			50			7	0.0		0.000	SM/CL	Light gray fine SAND, over 10 inches of semi stiff gray CLAY, thin sand lenses scattered in clay.
						8					
						14					
						13					
						10					
			52.0			12	0.0		0.000	SM/CL	
						21					
						15					

Well Set at 44 ft.

BORING LOG

Site Name: LCP Chemicals Site, Brunswick GA



Boring No: SW-47

Diameter: 8 in

Date: 08/05/2013

Northing (ft): 432395.12

Easting (ft): 861754.60

Elevation (ft): 9.82

Total Depth: 53.3 Ft

Driller: Groundwater Protection Inc

Method: Mud Rotary

Consultant: PARSONS

Project No: 448517

Datum: NAVD88

Coordinate System:

NAD 1983 State Plane

Georgia East / FIPS 1001

Depth Ft	Recov	Sample ID	Blow Count	PID (ppm)	Mercury (mg/m3)	USCS Code	Soil Description	Well Construction Diagram
0							Hand cleared to 5 ft. Installed with a stick up above ground surface.	
5								
10							pH is 7.5.	
15				0.0	0.000			

BORING LOG



Site Name: LCP Chemicals Site, Brunswick GA
 Boring No: SW-47
 Diameter: 8 in
 Date: 08/05/2013

Northing (ft): 432395.12
 Easting (ft): 861754.60
 Elevation (ft): 9.82
 Total Depth: 53.3 Ft

Driller: Groundwater Protection Inc
 Method: Mud Rotary
 Consultant: PARSONS
 Project No: 448517

Datum: NAVD88
 Coordinate System:
 NAD 1983 State Plane
 Georgia East / FIPS 1001

Depth Ft	Recov	Sample ID	Blow Count	PID (ppm)	Mercury (mg/m3)	USCS Code	Soil Description	Well Construction Diagram
15				0.0	0.000		pH is 7.5.	
20						pH is 7.		
25				0.0	0.000			
30								

BORING LOG



Site Name: LCP Chemicals Site, Brunswick GA
 Boring No: SW-47
 Diameter: 8 in
 Date: 08/05/2013

Northing (ft): 432395.12
 Easting (ft): 861754.60
 Elevation (ft): 9.82
 Total Depth: 53.3 Ft

Driller: Groundwater Protection Inc
 Method: Mud Rotary
 Consultant: PARSONS
 Project No: 448517

Datum: NAVD88
 Coordinate System:
 NAD 1983 State Plane
 Georgia East / FIPS 1001

Depth Ft	Recov	Sample ID	Blow Count	PID (ppm)	Mercury (mg/m3)	USCS Code	Soil Description	Well Construction Diagram	
45			20	0.0	0.000	SM	Gray medium to coarse SAND, fine to medium sand bottom 1/2, wet.		
			23						
			7						
			11	0.0	0.000	CL	Gray CLAY, trace silt, thin sand lenses, semi stiff, moist to wet.		
			10						
			7						
			4	0.0	0.000	CL	Gray CLAY, thin fine sand lenses 1/2 inch at bottom of sample, wet.		
			5						
			8						
		50		6	0.0	0.000	CL		Gray CLAY, thin fine sand lenses, thin and scattered, wet.
				4					
				4					
				3					
		53.3		12	0.0	0.000	CL		Gray CLAY, thin fine sand lenses, thin and scattered, wet.
				8					
				54/4	0.0	0.000	SM		Clay as above, alternating with fine to medium SAND 1-1.5 inch layers.
									Gray fine to medium SAND, trace silt, sandstone at bottom of sample, wet.

Well Set at 47 ft.

BORING LOG



Site Name: LCP Chemicals Site, Brunswick GA

Boring No: SW-48

Diameter: 8 in

Date: 08/12/2013 - 08/13/2013

Northing (ft): 431469.81
 Easting (ft): 861833.84
 Elevation (ft): 10.29
 Total Depth: 50.33 Ft

Driller: Groundwater Protection Inc
 Method: Mud Rotary
 Consultant: Mutch Associates
 Project No: 448517

Datum: NAVD88
 Coordinate System:
 NAD 1983 State Plane
 Georgia East / FIPS 1001

Depth Ft	Recov	Sample ID	Blow Count	PID (ppm)	Mercury (mg/m3)	USCS Code	Soil Description	Well Construction Diagram
30							Brown gray drilling MUD, pH is 7 to 8.	
35				0.5	0			
40			6	0	0	SM	Gray fine to coarse SAND, trace silt.	
			9					
			12			SM	Gray fine to coarse SAND, trace silt.	
			12					
			13	0	0	SC	Gray fine to coarse SAND, trace silt, occasional lens clay .	
			5					
			7			SC	Gray fine to coarse SAND, trace silt, occasional lens clay .	
			9					
			7	0	0	SM	Gray fine to coarse SAND, trace silt.	
45			7					

BORING LOG



Site Name: LCP Chemicals Site, Brunswick GA
 Boring No: SW-48
 Diameter: 8 in
 Date: 08/12/2013 - 08/13/2013

Northing (ft): 431469.81
 Easting (ft): 861833.84
 Elevation (ft): 10.29
 Total Depth: 50.33 Ft

Driller: Groundwater Protection Inc
 Method: Mud Rotary
 Consultant: Mutch Associates
 Project No: 448517

Datum: NAVD88
 Coordinate System:
 NAD 1983 State Plane
 Georgia East / FIPS 1001

Depth Ft	Recov	Sample ID	Blow Count	PID (ppm)	Mercury (mg/m3)	USCS Code	Soil Description	Well Construction Diagram		
45	[Diagram showing recovery status: mostly black, some white]		11	0	0	SC	Gray fine to medium SAND, trace silt, 3 inch layer clay, stiff.	[Well Construction Diagram]		
			15							
			7						SM	Gray fine to coarse SAND, trace silt.
			13							
			17						SC	Gray fine to medium SAND, some clayey silt.
			22							
			12		0	0	SM/SC		48 ft to 48 ft 6 in Gray fine to coarse SAND, trace silt, 48 ft 6 in to 49 ft Gray fine to medium SAND and clayey silt.	
			18							
			20						SM/SC	49 ft to 49 ft 6 in Gray fine to medium SAND, and clayey silt, 49 ft 6 in to 50 ft fine to coarse SAND, little silt.
			20							
50			50			SM/R	Gray fine to coarse SAND, little silt, 2 inch weakly cemented sandstone.			
50.33										

Well Set at 47 ft.

BORING LOG



Site Name: LCP Chemicals Site, Brunswick GA
 Boring No: SW-49
 Diameter: 8 in
 Date: 08/13/2013

Northing (ft): 431551.26
 Easting (ft): 861825.95
 Elevation (ft): 13.30
 Total Depth: 54.33 Ft

Driller: Groundwater Protection Inc
 Method: Mud Rotary
 Consultant: Mutch Associates
 Project No: 448517

Datum: NAVD88
 Coordinate System:
 NAD 1983 State Plane
 Georgia East / FIPS 1001

Depth Ft	Recov	Sample ID	Blow Count	PID (ppm)	Mercury (mg/m3)	USCS Code	Soil Description	Well Construction Diagram
30							Brown gray drilling MUD, pH 7 to 8.	
35				0.5	0			
40			12	0	0	SM	Gray fine to medium SAND, trace silt.	
			17					
			17			SM	Gray fine to medium SAND, trace silt.	
			12					
			5	0	0	SM	Gray fine to medium SAND, trace silt.	
			5					
			8					
			8			SM	Gray fine to medium SAND, trace silt.	
			5					
45			10	0	0	SM	Gray fine to medium SAND, trace silt.	

BORING LOG



Site Name: LCP Chemicals Site, Brunswick GA
 Boring No: SW-49
 Diameter: 8 in
 Date: 08/13/2013

Northing (ft): 431551.26
 Easting (ft): 861825.95
 Elevation (ft): 13.30
 Total Depth: 54.33 Ft

Driller: Groundwater Protection Inc
 Method: Mud Rotary
 Consultant: Mutch Associates
 Project No: 448517

Datum: NAVD88
 Coordinate System:
 NAD 1983 State Plane
 Georgia East / FIPS 1001

Depth Ft	Recov	Sample ID	Blow Count	PID (ppm)	Mercury (mg/m3)	USCS Code	Soil Description	Well Construction Diagram
45			15	0	0	SM	Gray fine to coarse SAND, trace silt, occasional piece of coarse gravel.	
			16			SM	Gray fine to coarse SAND, trace silt.	
			8			SM	Gray fine to coarse SAND, trace silt.	
			13			SM	Gray fine to coarse SAND, trace silt.	
			13	SM	Gray fine to coarse SAND, trace silt.			
			19	SM	Gray fine to coarse SAND, trace silt.			
			7	SM	Gray fine to coarse SAND, trace silt.			
			11	SM	Gray fine to coarse SAND, trace silt.			
			13	SM	Gray fine to coarse SAND, trace silt.			
			17	SM	Gray fine to coarse SAND, trace silt.			
50			4	SM	Gray fine to coarse SAND, trace silt.			
			8	SM	Gray fine to coarse SAND, trace silt.			
			11	SM	Gray fine to coarse SAND, trace silt.			
			20	SM	Gray fine to coarse SAND, trace silt.			
			25	SM	52 ft to 52 ft 6 in Gray fine to medium SAND, 52 ft 6 in to 53 ft Gray fine to coarse SAND, trace white shell fragments, little clayey silt.			
			26	SM	Gray fine to medium SAND, little silt.			
			8	SM	Gray fine to medium SAND, little silt.			
			12	SM	Gray fine to medium SAND, little silt.			
			50	SM/R	54 ft to 54 ft 4 in fine to medium SAND, some silt, 1/4 inch layer Gray cemented stone.			

54.7

Well Set at 52.5 ft. Well moved 5 ft. SE because of incline of hill and proximity to infiltration galleries.

BORING LOG



Site Name: LCP Chemicals Site, Brunswick GA

Boring No: SW-50

Diameter: 8 in

Date: 07/31/2013 - 08/05/2013

Northing (ft): 431794.98
 Easting (ft): 861827.26
 Elevation (ft): 10.19
 Total Depth: 52.0 Ft

Driller: Groundwater Protection Inc
 Method: Mud Rotary
 Consultant: PARSONS
 Project No: 448517

Datum: NAVD88
 Coordinate System:
 NAD 1983 State Plane
 Georgia East / FIPS 1001

Depth Ft	Recov	Sample ID	Blow Count	PID (ppm)	Mercury (mg/m3)	USCS Code	Soil Description	Well Construction Diagram
30							pH is 7.5 to 8.	
35				0.0	0.000			
40			11	0.0	0.000	SM	Gray medium to coarse SAND, fine to medium sand, darker gray at bottom, wet. pH is 7.0 to 8.	
			14					
			18					
			28					
			20	0.0	0.000	SM	Gray medium to coarse SAND, bottom 2 inches silt and clay lense, semi stiff, wet.	
			25					
			20					
			19					
			12	0.0	0.000	SM	Gray medium to coarse SAND, thin silt and clay lense 1/4 inch, wet.	
			13					
45								

BORING LOG



Site Name: LCP Chemicals Site, Brunswick GA
 Boring No: SW-50
 Diameter: 8 in
 Date: 07/31/2013 - 08/05/2013

Northing (ft): 431794.98
 Easting (ft): 861827.26
 Elevation (ft): 10.19
 Total Depth: 52.0 Ft

Driller: Groundwater Protection Inc
 Method: Mud Rotary
 Consultant: PARSONS
 Project No: 448517

Datum: NAVD88
 Coordinate System:
 NAD 1983 State Plane
 Georgia East / FIPS 1001

Depth Ft	Recov	Sample ID	Blow Count	PID (ppm)	Mercury (mg/m3)	USCS Code	Soil Description	Well Construction Diagram
45			11			SM	Gray medium to coarse SAND, thin silt and clay lense 1/4 inch, wet.	
			13					
			3	0.0	0.000		Same as above, grading to fine to medium SAND.	
			4			SM		
			9					
			16					
			9	0.0	0.000		Same as above, grading to fine SAND, trace silt, trace shells, trace thin lenses of silt and clay, upper sample.	
			36			SM		
			50/5					
50			29	0.0	0.000	SM	Gray fine SAND, some silt, trace clay, wet.	
			50/6	0.0	0.000			
			35	0.0	0.000	SM	Gray fine SAND, some silt, trace shells, more dense, trace pebbles, wet.	
52.0			50/5				Same as above over dark gray hard sandstone, hard refusal.	

Well Set at 51 ft.

BORING LOG



Site Name: LCP Chemicals Site, Brunswick GA

Boring No: SW-51

Diameter: 8 in

Date: 07/28/2013

Northing (ft): 431876.55
 Easting (ft): 861825.02
 Elevation (ft): 10.16
 Total Depth: 53.0 Ft

Driller: Groundwater Protection Inc
 Method: Mud Rotary
 Consultant: PARSONS
 Project No: 448517

Datum: NAVD88
 Coordinate System:
 NAD 1983 State Plane
 Georgia East / FIPS 1001

Depth Ft	Recov	Sample ID	Blow Count	PID (ppm)	Mercury (mg/m3)	USCS Code	Soil Description	Well Construction Diagram
0							Hand cleared to 5 ft. Installed with a stick up above ground surface. pH is 7.	
5				0.0	0.000			
10							pH is 7.	
15				0.0	0.000			

BORING LOG



Site Name: LCP Chemicals Site, Brunswick GA
 Boring No: SW-51
 Diameter: 8 in
 Date: 07/28/2013

Northing (ft): 431876.55
 Easting (ft): 861825.02
 Elevation (ft): 10.16
 Total Depth: 53.0 Ft

Driller: Groundwater Protection Inc
 Method: Mud Rotary
 Consultant: PARSONS
 Project No: 448517

Datum: NAVD88
 Coordinate System:
 NAD 1983 State Plane
 Georgia East / FIPS 1001

Depth Ft	Recov	Sample ID	Blow Count	PID (ppm)	Mercury (mg/m3)	USCS Code	Soil Description	Well Construction Diagram
45			10			ML	Gray medium to coarse SAND, little fine sand, trace silt, wet, swampy odor, no stain or sheen.	
			7					
			6	0.1	0.008			
			10					
			13			SM	Same as above top 14 inches, bottom 6 inches fine SAND, some silt, lenses of gray clay, little silt.	
			12					
			7	0.1	0.000			
			21			SM	Gray medium to coarse SAND, lenses of fine to medium sand, bottom 6 inches gray silt, fine SAND, trace clay, trace shells broken, wet.	
			25					
			21					
50			20	0.00	0.004	SM	Brown fine SAND, little silt, trace broken shells, wet.	
			20	0.2	0.009	SM	Brown fine SAND, little silt, trace broken shells, wet.	
			18	0.1	0.000			
			18	0.1	0.003	SM	Same as above, trace mudstone, rock clast in bottom.	
			50/4	0.1	0.005			
				0.0	0.000		Brown SILT, some fine sand, trace shells, wet.	

53.0

Well Set at 52 ft.

BORING LOG



Site Name: LCP Chemicals Site, Brunswick GA
 Boring No: SW-52
 Diameter: 8 in
 Date: 07/29/2013

Northing (ft): 431955.28
 Easting (ft): 861824.23
 Elevation (ft): 10.12
 Total Depth: 51.5 Ft

Driller: Groundwater Protection Inc
 Method: Mud Rotary
 Consultant: Mutch Associates
 Project No: 448517

Datum: NAVD88
 Coordinate System:
 NAD 1983 State Plane
 Georgia East / FIPS 1001

Depth Ft	Recov	Sample ID	Blow Count	PID (ppm)	Mercury (mg/m3)	USCS Code	Soil Description	Well Construction Diagram
30							Brown drilling MUD, pH 8 to 9.	
35				328	0			
40			12	0	0	SM	Gray fine to coarse SAND, trace silt.	
			15			SM	Gray fine to coarse SAND, trace silt.	
			15					
			16					
			8	0	0	SC	Gray fine to coarse SAND, trace silt, occasional lens clay.	
			11					
			13			SC	Gray fine to coarse SAND, trace silt, occasional lens clay.	
			11					
			4	0	0	SM	Gray fine to coarse SAND, trace silt.	
45			4					

BORING LOG



Site Name: LCP Chemicals Site, Brunswick GA
 Boring No: SW-52
 Diameter: 8 in
 Date: 07/29/2013

Northing (ft): 431955.28
 Easting (ft): 861824.23
 Elevation (ft): 10.12
 Total Depth: 51.5 Ft

Driller: Groundwater Protection Inc
 Method: Mud Rotary
 Consultant: Mutch Associates
 Project No: 448517

Datum: NAVD88
 Coordinate System:
 NAD 1983 State Plane
 Georgia East / FIPS 1001

Depth Ft	Recov	Sample ID	Blow Count	PID (ppm)	Mercury (mg/m3)	USCS Code	Soil Description	Well Construction Diagram	
45			6	0	0	CL	Gray CLAY, little sand.		
			7			SM/SC	46 ft to 46 ft 6 in Gray fine to coarse SAND, trace silt, 46 ft 6 in to 47 ft Gray brown fine to medium SAND, trace silt, occasional lens clay, a 1 inch layer clay, odor sulfur like.		
			5						
			12						
			28	SC	Gray brown fine to medium SAND, occasional lens clay, odor sulfur like.				
			35						
			7	0	0				SC
			5						
			8						
			12	0	0	SC	Gray SAND, some clay and silt, trace white shell fragments.		
50			14			SC	Gray brown fine to medium SAND, occasional lens clay, little silt, trace white shell fragments, odor sulfur like.		
			7						
51.5				50			SM/R		Gray brown fine to medium SAND, some silt, first 4 inches 7 blows, last 2 inches over 43, refusal.

Well Set at 51.5 ft.

BORING LOG



Site Name: LCP Chemicals Site, Brunswick GA
 Boring No: SW-53
 Diameter: NA
 Date: 07/28/2013

Northing (ft): 432027.09
 Easting (ft): 861823.43
 Elevation (ft): 9.36
 Total Depth: 51.0 Ft

Driller: Groundwater Protection Inc
 Method: Mud Rotary
 Consultant: Mutch Associates
 Project No: 448517

Datum: NAVD88
 Coordinate System:
 NAD 1983 State Plane
 Georgia East / FIPS 1001

Depth Ft	Recov	Sample ID	Blow Count	PID (ppm)	Mercury (mg/m3)	USCS Code	Soil Description	Well Construction Diagram
30							Brown drilling MUD, pH 7 to 8.	
35				147	0			
40			9	0	0	SM	Gray brown fine to coarse SAND, trace silt.	
			11					
			15					
			20			SM	Gray brown fine to coarse SAND, trace silt.	
			11	0	0	SM	Gray brown fine to coarse SAND, trace silt.	
			14					
			17					
			22			SM	Gray brown fine to coarse SAND, trace silt.	
			10					
45			12	0	0	SM	Gray brown fine to coarse SAND, trace silt.	

BORING LOG



Site Name: LCP Chemicals Site, Brunswick GA
 Boring No: SW-53
 Diameter: NA
 Date: 07/28/2013

Northing (ft): 432027.09
 Easting (ft): 861823.43
 Elevation (ft): 9.36
 Total Depth: 51.0 Ft

Driller: Groundwater Protection Inc
 Method: Mud Rotary
 Consultant: Mutch Associates
 Project No: 448517

Datum: NAVD88
 Coordinate System:
 NAD 1983 State Plane
 Georgia East / FIPS 1001

Depth Ft	Recov	Sample ID	Blow Count	PID (ppm)	Mercury (mg/m3)	USCS Code	Soil Description	Well Construction Diagram
45	RECOVERED		16	0	0	SM/CL	45 ft to 45 ft 6 in Gray fine to coarse SAND, trace silt, 45 ft 6 in to 46 ft Gray CLAY, stiff, occasional 1/2 inch layers of clayey sand, trace silt.	
			19			SM	Gray fine to coarse SAND, trace silt.	
			12			SM	47 ft to 47 ft 6 in Gray fine to coarse SAND, trace silt, 47 ft 6 in to 48 ft Gray brown fine to medium SAND, trace silt, brown liquid, sulfur like odor.	
			14			SC	48 ft to 48 ft 10 in Gray brown fine to medium SAND, trace silt, occasional lens clay, 48 ft 10 in to 49 ft Gray CLAY, stiff.	
			18			SC/SM	49 ft to 49 ft 6 in Gray fine to medium SAND, little clayey silt, trace white shell fragments, 49 ft 6 in to 50 ft Gray fine to medium SAND, little silt, 1/8 inch layers of white shell fragments.	
			28	SC	Gray SILT, little fine to medium sand, occasional lens clay.			
			30	SC/R	51 ft to 51 ft 6 in Gray fine to medium SAND, some silt, occasional lens of clay, 51 ft 6 in to 52 ft Gray CLAY, stiff, dry, piece of stone in tip of spoon.			
			13					
			15					
			18					
			11					
			14					
			6					
			50					

Well Set at 48.5 ft.

BORING LOG



Site Name: LCP Chemicals Site, Brunswick GA
 Boring No: SW-54
 Diameter: 8 in
 Date: 08/10/2013 - 08/11/2013

Northing (ft): 432116.27
 Easting (ft): 861782.23
 Elevation (ft): 9.24
 Total Depth: 51.5 Ft

Driller: Groundwater Protection Inc
 Method: Mud Rotary
 Consultant: PARSONS
 Project No: 448517

Datum: NAVD88
 Coordinate System:
 NAD 1983 State Plane
 Georgia East / FIPS 1001

Depth Ft	Recov	Sample ID	Blow Count	PID (ppm)	Mercury (mg/m3)	USCS Code	Soil Description	Well Construction Diagram						
45			13	0.0	0.000	CL	Greenish gray CLAY, interbedded with thin fine sand lenses, coarse sand, fine gravel in top, wet.							
			7				SM/CL		Medium to coarse SAND, mixed with silt and clay over greenish gray CLAY, little silt, wet.					
			9			CL			Greenish gray CLAY, little silt, moist.					
			7				CL		Greenish gray CLAY, little silt, moist.					
			8			CL			Greenish gray CLAY, little silt, moist.					
			9				CL		Greenish gray CLAY, little silt, moist.					
			5			CL			Greenish gray CLAY, little silt, moist.					
			8				CL		Greenish gray CLAY, little silt, moist.					
			3			CL			Greenish gray CLAY, little silt, moist.					
			3				CL		Greenish gray CLAY, little silt, moist.					
			50							5	0.0	0.000		Upper 5 inches same as above, bottom gray weathered sandstone, chunks of sandstone in sample.
							4			Weathered SANDSTONE, fine to medium sand, little silt and clay, chunks of sandstone in sample.				
							50/1			Weathered sandstone, dense, hard refusal.				
51.5														

Well Set at 46 ft.

BORING LOG



Site Name: LCP Chemicals Site, Brunswick GA
 Boring No: SW-55
 Diameter: 8 in
 Date: 08/12/2013

Northing (ft): 432199.50
 Easting (ft): 861787.16
 Elevation (ft): 9.10
 Total Depth: 52.25 Ft

Driller: Groundwater Protection Inc
 Method: Mud Rotary
 Consultant: PARSONS
 Project No: 448517

Datum: NAVD88
 Coordinate System:
 NAD 1983 State Plane
 Georgia East / FIPS 1001

Depth Ft	Recov	Sample ID	Blow Count	PID (ppm)	Mercury (mg/m3)	USCS Code	Soil Description	Well Construction Diagram
30								
35				0.0	0.000			
40								
			5	0.00	0.000	SM/CL	Gray fine to medium SAND, trace silt and clay at bottom of sand, greenish gray CLAY semi stiff, wet.	
			11					
			15					
			11			CL	Greenish gray CLAY, semi stiff, wet.	
			6	0.0	0.000			
45			8					

BORING LOG



Site Name: LCP Chemicals Site, Brunswick GA
 Boring No: SW-55
 Diameter: 8 in
 Date: 08/12/2013

Northing (ft): 432199.50
 Easting (ft): 861787.16
 Elevation (ft): 9.10
 Total Depth: 52.25 Ft

Driller: Groundwater Protection Inc
 Method: Mud Rotary
 Consultant: PARSONS
 Project No: 448517

Datum: NAVD88
 Coordinate System:
 NAD 1983 State Plane
 Georgia East / FIPS 1001

Depth Ft	Recov	Sample ID	Blow Count	PID (ppm)	Mercury (mg/m3)	USCS Code	Soil Description	Well Construction Diagram
45			7	0.0	0.000	CL	Greenish gray CLAY, semi stiff, wet.	
			6			SM/CL	Tan fine to medium SAND 6 inches over clay as above 5 inches, over fine medium SAND, little clay in thin lenses, wet.	
			4					
			7					
			15					
			16	SM/CL	Sand as above 3 inches over greenish gray CLAY.			
			4					
			6					
			8	CL	Clay as above 4 inches over gray fine to medium SAND, grading to weathered sandstone.			
			8					
50			7					
			14					
			14					
			17					
52.25			50/3	Well Set at 42.5 ft.		Drove 3 inches, weathered sandstone as above, hard refusal.		

BORING LOG



Site Name: LCP Chemicals Site, Brunswick GA
 Boring No: SW-56
 Diameter: 8 in
 Date: 08/08/2013 - 08/09/2013

Northing (ft): 432265.58
 Easting (ft): 861808.22
 Elevation (ft): 8.70
 Total Depth: 52.5 Ft

Driller: Groundwater Protection Inc
 Method: Mud Rotary
 Consultant: PARSONS
 Project No: 448517

Datum: NAVD88
 Coordinate System:
 NAD 1983 State Plane
 Georgia East / FIPS 1001

Depth Ft	Recov	Sample ID	Blow Count	PID (ppm)	Mercury (mg/m3)	USCS Code	Soil Description	Well Construction Diagram
45			9			CL	Gray medium SAND 2 inches, trace clay over 20 inches greenish gray CLAY, some silt grading to clay, 2 inches sand, little clay at bottom, wet.	
			11					
			5	0.0	0.000	GM/CL	Gray GRAVEL, little sand, trace clay 10 inches, over greenish gray CLAY, bottom 2 inches trace silt, wet.	
			6					
			6					
			11			CL	Greenish gray CLAY, trace silt in lenses, semi stiff, wet.	
			4	0.0	0.000			
			6					
			6			ML/CL	Greenish gray SILT and CLAY, wet.	
			11					
50			4	0.0	0.000			
			5	0.0	0.000		Light gray fine SAND, heavily weathered, wet.	
			10	0.0	0.000			
			4	0.0	0.000		Same as above, stiffening to sandstone, hard refusal.	
			50/3	0.0	0.000			

Well Set at 47.5 ft.

BORING LOG



Site Name: LCP Chemicals Site, Brunswick GA

Boring No: SW-57

Diameter: 8 in

Date: 08/06/2013

Northing (ft): 432355.26
 Easting (ft): 861823.47
 Elevation (ft): 10.20
 Total Depth: 53.6 Ft

Driller: Groundwater Protection Inc
 Method: Mud Rotary
 Consultant: PARSONS
 Project No: 448517

Datum: NAVD88
 Coordinate System:
 NAD 1983 State Plane
 Georgia East / FIPS 1001

Depth Ft	Recov	Sample ID	Blow Count	PID (ppm)	Mercury (mg/m3)	USCS Code	Soil Description	Well Construction Diagram
0							Hand cleared to 5 ft. Installed with a stick up above ground surface. pH is 7.	
5				0.0	0.000			
10							pH is 7.	
15				0.0	0.000			

BORING LOG

Site Name: LCP Chemicals Site, Brunswick GA

Boring No: SW-57

Diameter: 8 in

Date: 08/06/2013



Northing (ft): 432355.26
 Easting (ft): 861823.47
 Elevation (ft): 10.20
 Total Depth: 53.6 Ft

Driller: Groundwater Protection Inc
 Method: Mud Rotary
 Consultant: PARSONS
 Project No: 448517

Datum: NAVD88
 Coordinate System:
 NAD 1983 State Plane
 Georgia East / FIPS 1001

Depth Ft	Recov	Sample ID	Blow Count	PID (ppm)	Mercury (mg/m3)	USCS Code	Soil Description	Well Construction Diagram					
45			13	0.0	0.000	SM	Gray medium to coarse SAND, some silt and clay throughout, wet.						
			16										
			7			SM	Gray fine to coarse SAND, little silt and clay in lenses, wet.						
			8										
			10										
			12			CL	Greenish gray CLAY, bottom 5 inches fine to coarse sand, some silt and clay, medium stiff.						
			4										
			2										
			3										
			50						4	0.0	0.000	CL	Greenish gray CLAY, lense of fine to medium sand 5 inches thick, thinner lenses of similar sand below, medium stiff.
									8				
									7				
									12				
19													
53.6			13	0.0	0.000	CL	CLAY as above in shoe, fine to medium sand above, looks like caved wash sand?						
			11			SM	Gray fine SAND, wet.						
			8			SM	Gray fine SAND, some silt, little clay.						

Well Set at 48 ft.

BORING LOG



Site Name: LCP Chemicals Site, Brunswick GA
 Boring No: SW-58
 Diameter: 8 in
 Date: 07/26/2013

Northing (ft): 431954.66
 Easting (ft): 861754.70
 Elevation (ft): 10.11
 Total Depth: 51.5 Ft

Driller: Groundwater Protection Inc
 Method: Mud Rotary
 Consultant: PARSONS
 Project No: 448517

Datum: NAVD88
 Coordinate System:
 NAD 1983 State Plane
 Georgia East / FIPS 1001

Depth Ft	Recov	Sample ID	Blow Count	PID (ppm)	Mercury (mg/m3)	USCS Code	Soil Description	Well Construction Diagram	
45	[Symbol]		21	0.0	0.000	SC	Gray fine SAND, and clay, dry.	[Diagram]	
			20						
			14						
				36	0.0	0.000	SM		Gray fine to medium SAND, moist.
			20						
				20	0.0	0.000	CL		Gray CLAY, trace sand, dense, dry.
			5						
				12	0.0	0.000	SC		Gray fine SAND, some shells, laminated, trace clay, moist.
			21						
				29	0.0	0.000	SC		Gray fine SAND, some shells, laminated, trace clay, moist.
			20						
				15	0.0	0.000	SM		Gray fine to medium SAND, some shells, laminated, trace silt, moist.
				50	0.0	0.000	SM		Gray fine to medium SAND, little shells, laminated, trace silt, moist.
		50	0.0	0.000	SM	Gray fine to medium SAND, sandstone fragments in top of spoon.			

Well set at 51 ft, ground elevation 9.36 ft.

BORING LOG



Site Name: LCP Chemicals Site, Brunswick GA
 Boring No: SW-59
 Diameter: 8 in
 Date: 07/28/2013

Northing (ft): 431974.44
 Easting (ft): 861788.85
 Elevation (ft): 10.47
 Total Depth: 50.75 Ft

Driller: Groundwater Protection Inc
 Method: Mud Rotary
 Consultant: Mutch Associates
 Project No: 448517

Datum: NAVD88
 Coordinate System:
 NAD 1983 State Plane
 Georgia East / FIPS 1001

Depth Ft	Recov	Sample ID	Blow Count	PID (ppm)	Mercury (mg/m3)	USCS Code	Soil Description	Well Construction Diagram
15							Brown drilling MUD, pH 9 to 11, at 8 ft hit brick and other fill material, use different cutter head.	
20								
25				30	0			
30								

BORING LOG



Site Name: LCP Chemicals Site, Brunswick GA

Boring No: SW-59

Diameter: 8 in

Date: 07/28/2013

Northing (ft): 431974.44
 Easting (ft): 861788.85
 Elevation (ft): 10.47
 Total Depth: 50.75 Ft

Driller: Groundwater Protection Inc
 Method: Mud Rotary
 Consultant: Mutch Associates
 Project No: 448517

Datum: NAVD88
 Coordinate System:
 NAD 1983 State Plane
 Georgia East / FIPS 1001

Depth Ft	Recov	Sample ID	Blow Count	PID (ppm)	Mercury (mg/m3)	USCS Code	Soil Description	Well Construction Diagram
30							Brown drilling MUD, pH 9 to 11, at 8 ft hit brick and other fill material, use different cutter head.	
35				30	0			
40			10	0	0	SM	Gray brown fine to coarse SAND, trace silt.	
			11			SM	Gray brown fine to coarse SAND, trace silt.	
			15					
			9	0	0	SM	Gray brown fine to coarse SAND, trace silt.	
			11					
			10					
			11			SC	43 ft to 43 ft 6 in in Gray brown fine to coarse SAND, trace silt, 43 ft 6 in to 44 ft Gray fine to medium SAND, trace silt, occasional lens clay.	
			4	0	0	SC/CL	44 ft to 44 ft 6 in in Gray fine to coarse SAND, trace silt, occasional lens clay, 44 ft 6 in to 45 ft Gray CLAY and silt, occasional layer of 1/2 inch Brown fine to coarse SAND, trace silt, wet.	
45			4					

BORING LOG



Site Name: LCP Chemicals Site, Brunswick GA
 Boring No: SW-59
 Diameter: 8 in
 Date: 07/28/2013

Northing (ft): 431974.44
 Easting (ft): 861788.85
 Elevation (ft): 10.47
 Total Depth: 50.75 Ft

Driller: Groundwater Protection Inc
 Method: Mud Rotary
 Consultant: Mutch Associates
 Project No: 448517

Datum: NAVD88
 Coordinate System:
 NAD 1983 State Plane
 Georgia East / FIPS 1001

Depth Ft	Recov	Sample ID	Blow Count	PID (ppm)	Mercury (mg/m3)	USCS Code	Soil Description	Well Construction Diagram
45			6	0	0	CL	Gray CLAY and silt, occasional layer 0.5 inch Brown fine to coarse sand, trace silt, wet.	
		9						
		6						
		15						
		14				SC	Gray brown fine to medium SAND, trace silt, occasional lens clay.	
		15				SC	47 ft to 47 ft 4 in Gray fine to medium SAND, trace silt, occasional lens clay, 47 ft 4 in to 48 ft Gray fine to medium SAND, trace silt, trace white shell fragments, 4 inch layer Gray silt and clay.	
		10		0	0	ML	Gray clayey SILT, trace fine to medium sand, trace white shell fragments.	
		15						
		17						
		17				ML/SM	49 ft to 49 ft 6 in Gray clayey SILT, trace fine to medium sand, trace white shell fragments, 49 ft 6 in to 50 ft Gray brown fine to medium SAND, little silt, trace white shell fragments.	
50			27	0	0	SM/R	Gray brown fine to medium SAND, little silt, trace white shell fragments, refusal.	
50.75			50					

Well Set at 50.5 ft.

BORING LOG



Site Name: LCP Chemicals Site, Brunswick GA
 Boring No: SW-60
 Diameter: 8 in
 Date: 07/26/2013

Northing (ft): 432076.62
 Easting (ft): 861887.87
 Elevation (ft): 11.53
 Total Depth: 52.83 Ft

Driller: Groundwater Protection Inc
 Method: Mud Rotary
 Consultant: Mutch Associates
 Project No: 448517

Datum: NAVD88
 Coordinate System:
 NAD 1983 State Plane
 Georgia East / FIPS 1001

Depth Ft	Recov	Sample ID	Blow Count	PID (ppm)	Mercury (mg/m3)	USCS Code	Soil Description	Well Construction Diagram
30							Brown drilling MUD, pH 7 to 8.	
35				30	0			
40			12	0	0			
			18					
			18			SM	Gray brown fine to coarse SAND, trace silt.	
			19					
			11	0	0	SC	Gray brown fine to coarse SAND, little silt, occasional lens clay.	
			14					
			14			SM	Gray fine to coarse SAND, trace silt.	
			14					
			9					
45			13	0	0	SM	Gray fine to coarse SAND, trace silt.	

BORING LOG



Site Name: LCP Chemicals Site, Brunswick GA
 Boring No: SW-60
 Diameter: 8 in
 Date: 07/26/2013

Northing (ft): 432076.62
 Easting (ft): 861887.87
 Elevation (ft): 11.53
 Total Depth: 52.83 Ft

Driller: Groundwater Protection Inc
 Method: Mud Rotary
 Consultant: Mutch Associates
 Project No: 448517

Datum: NAVD88
 Coordinate System:
 NAD 1983 State Plane
 Georgia East / FIPS 1001

Depth Ft	Recov	Sample ID	Blow Count	PID (ppm)	Mercury (mg/m3)	USCS Code	Soil Description	Well Construction Diagram			
45			15	0	0	SM	Gray fine to coarse SAND, trace silt.				
			14								
			10								
			14				SM		Gray fine to coarse SAND, trace silt.		
			16				SM/CL		47 ft to 47 ft 8 in Gray fine to coarse SAND, trace silt, 47 ft 8 in to 48 ft silty CLAY, trace sand.		
			21								
			7		0	0	SC		48 ft to 48 ft 6 in Gray SAND, some silty clay, 48 ft 6 in to 49 ft Gray silty clay.		
			9								
			8							CL	Gray silty CLAY.
			11								
50			8		0	0	CL		Gray CLAY, stiff, occasional layer fine to medium sand, some silt.		
			6								
			7							SC	Gray coarse SAND, some silt and clay, wet.
			9								
			7							SM/R	Gray fine to coarse SAND, trace shell fragments, dark Gray pieces of weakly cemented sandstone in tip of spoon.
52.833		50									

Well Set at 47.5 ft.

BORING LOG



Site Name: LCP Chemicals Site, Brunswick GA
 Boring No: SW-61
 Diameter: 8 in
 Date: 07/30/2013

Northing (ft): 432153.94
 Easting (ft): 861902.30
 Elevation (ft): 11.86
 Total Depth: 53.33 Ft

Driller: Groundwater Protection Inc
 Method: Mud Rotary
 Consultant: Mutch Associates
 Project No: 448517

Datum: NAVD88
 Coordinate System:
 NAD 1983 State Plane
 Georgia East / FIPS 1001

Depth Ft	Recov	Sample ID	Blow Count	PID (ppm)	Mercury (mg/m3)	USCS Code	Soil Description	Well Construction Diagram
30							Brown gray drilling MUD, pH 11 to 12, at 8 ft bgs hit concrete and dense fill used 8 inch drill bit for 2 1/2 hours, moved hole 5 ft East.	
35				0.5	0			
40			14	0	0	SM	Gray brown fine to coarse SAND, trace silt.	
			16				Gray brown fine to coarse SAND, trace silt.	
			17				Gray brown fine to coarse SAND, trace silt.	
			17					
			8	0	0	SM	Gray brown fine to coarse SAND, trace silt.	
			14				Gray brown fine to coarse SAND, trace silt.	
			18					
			21					
			12	0	0	SM	Gray brown fine to medium SAND, trace silt.	
			11					
45								

BORING LOG



Site Name: LCP Chemicals Site, Brunswick GA
 Boring No: SW-61
 Diameter: 8 in
 Date: 07/30/2013

Northing (ft): 432153.94
 Easting (ft): 861902.30
 Elevation (ft): 11.86
 Total Depth: 53.33 Ft

Driller: Groundwater Protection Inc
 Method: Mud Rotary
 Consultant: Mutch Associates
 Project No: 448517

Datum: NAVD88
 Coordinate System:
 NAD 1983 State Plane
 Georgia East / FIPS 1001

Depth Ft	Recov	Sample ID	Blow Count	PID (ppm)	Mercury (mg/m3)	USCS Code	Soil Description	Well Construction Diagram		
45			14	0	0	CL	Gray CLAY, stiff, 1/2 inch layer fine to coarse sand, dry.			
			21			SC	Gray brown fine to medium SAND, lens clay.			
			7				Gray fine to coarse SAND, trace silt, 2 inch layer of Gray clay and silt.			
			10	0	0	SC	Gray fine to coarse SAND, trace silt.			
			10			SM	49 ft to 49 ft 4 in in Gray fine to coarse SAND, trace silt, 49 ft 4 in to 50 ft SILT and clay.			
			11			SM/SC	Gray fine to coarse SAND, trace silt.			
			9	0	0	SM	Gray fine to coarse SAND, trace silt.			
			8			SM	Gray fine to coarse SAND, trace silt.			
			9			SC	51 ft to 51 ft 6 in in Gray fine to coarse SAND, trace silt, occasional lens of clay, 51 ft 6 in to 52 ft Gray CLAY, little sand.			
			9	0	0	SM	Gray fine to medium SAND, some silt, trace white shell fragments, 2 inch layer of clay.			
			15			SM	Gray fine to medium SAND, little silt, layers of white shells, layers of weakly cemented stone, moved 3 inches then started bouncing.			
			18			SC				
			18	47		SM				
			22							
			4							
			14							
53.33				47			SM/R		Gray fine to medium SAND, little silt, layers of white shells, layers of weakly cemented stone, moved 3 inches then started bouncing.	

Well Set at 49 ft.

BORING LOG



Site Name: LCP Chemicals Site, Brunswick GA
 Boring No: SW-62
 Diameter: 8 in
 Date: 08/10/2013 - 08/11/2013

Northing (ft): 432235.20
 Easting (ft): 861893.45
 Elevation (ft): 10.58
 Total Depth: 53.25 Ft

Driller: Groundwater Protection Inc
 Method: Mud Rotary
 Consultant: PARSONS
 Project No: 448517

Datum: NAVD88
 Coordinate System:
 NAD 1983 State Plane
 Georgia East / FIPS 1001

Depth Ft	Recov	Sample ID	Blow Count	PID (ppm)	Mercury (mg/m3)	USCS Code	Soil Description	Well Construction Diagram
30								
35				0.0	0.000			
40			9	0.0	0.000	SM	Gray medium to coarse SAND, wet.	
			17					
			15					
			13					
			6	0.0	0.000	SM	Gray medium to coarse SAND, trace clay in upper lenses, wet.	
			7					
			13					
			18					
			4	0.0	0.000	SM	Gray fine to medium SAND, trace clay in thin lenses upper sample, wet.	
45			8					

BORING LOG



Site Name: LCP Chemicals Site, Brunswick GA
 Boring No: SW-62
 Diameter: 8 in
 Date: 08/10/2013 - 08/11/2013

Northing (ft): 432235.20
 Easting (ft): 861893.45
 Elevation (ft): 10.58
 Total Depth: 53.25 Ft

Driller: Groundwater Protection Inc
 Method: Mud Rotary
 Consultant: PARSONS
 Project No: 448517

Datum: NAVD88
 Coordinate System:
 NAD 1983 State Plane
 Georgia East / FIPS 1001

Depth Ft	Recov	Sample ID	Blow Count	PID (ppm)	Mercury (mg/m3)	USCS Code	Soil Description	Well Construction Diagram
45			13	0.0	0.000	SM	Gray fine to medium SAND, trace clay in thin lenses upper sample, wet.	
			11			SM/CL	SAND as above over 7 inches greenish gray CLAY, little silt, semi stiff.	
			4			SM/CL		
			9			SM/CL		
			13			SM/CL		
			13			SM/CL		
			5			SM/CL	Fine to medium SAND, trace rounded pebbles, coarse sand over 6 inches greenish gray clay, trace fine sand in lenses, wet.	
			7			SM/CL		
			7			SM/CL		
			10			SM/CL		
50			3	0.0	0.000	CL	Same as above 6 inches.	
			1/2	0.0	0.000	CL		
			1/2	0.0	0.000	CL		
			3	0.0	0.000	CL	Greenish gray CLAY, trace fine sand in thin lenses, semi stiff.	
			19	0.0	0.000	CL	Clay as above, bottom inch fine SAND.	
			5	0.0	0.000	SM	Gray fine SAND, wet.	
53.25			50/3	0.0	0.000	SM		

Well Set at 49 ft.

BORING LOG



Site Name: LCP Chemicals Site, Brunswick GA

Boring No: SW-63

Diameter: 8 in

Date: 08/07/2013

Northing (ft): 432318.74

Easting (ft): 861884.81

Elevation (ft): 9.86

Total Depth: 53.0 Ft

Driller: Groundwater Protection Inc

Method: Mud Rotary

Consultant: PARSONS

Project No: 448517

Datum: NAVD88

Coordinate System:

NAD 1983 State Plane

Georgia East / FIPS 1001

Depth Ft	Recov	Sample ID	Blow Count	PID (ppm)	Mercury (mg/m3)	USCS Code	Soil Description	Well Construction Diagram
45			9			SM	Same as above, trace silt near bottom.	
			13					
			7	0.0	0.000			
			9			SM/CL	Same as above, thin clay lenses in lower sand, bottom 6 inches greenish gray CLAY, stiff, moist to wet.	
			14					
			8					
			7	0.0	0.000	CL	Same as in the bottom of last spoon.	
			6					
			2	0.0	0.000			
			3			SM/CL	Fine SAND 12 inches, over 12 inches of greenish gray CLAY, very thin sand lenses scattered, semi stiff, wet.	
50			4					
			6					
			5	0.0	0.000			
			8			SM/CL	Upper 3 inches fine SAND, some clay over 14 inches fine tan SAND, little medium sand, over 6 inches semi stiff greenish gray clay. Shoe had gray weathered sandstone, dense, trace coarse sand, pebbles, hard refusal.	
			11					
			50/4					

53.0

Well Set at 52.75 ft.

BORING LOG



Site Name: LCP Chemicals Site, Brunswick GA
 Boring No: SW-64
 Diameter: 8 in
 Date: 08/07/2013 - 08/08/2013

Northing (ft): 432393.53
 Easting (ft): 861905.21
 Elevation (ft): 10.42
 Total Depth: 53.5 Ft

Driller: Groundwater Protection Inc
 Method: Mud Rotary
 Consultant: PARSONS
 Project No: 448517

Datum: NAVD88
 Coordinate System:
 NAD 1983 State Plane
 Georgia East / FIPS 1001

Depth Ft	Recov	Sample ID	Blow Count	PID (ppm)	Mercury (mg/m3)	USCS Code	Soil Description	Well Construction Diagram
30							pH is 7.	
35								
40			15	0.0	0.000	SM	Gray medium to coarse SAND, trace silt and clay in thin lenses at top, wet.	
			15					
			16					
			20					
			16	0.0	0.000	SM	Gray medium to coarse SAND, grading to medium sand bottom 1/2 of sample, wet.	
			17					
			19					
			24					
			7	0.0	0.000	SM	Gray fine to medium SAND, wet.	
45			4					

BORING LOG



Site Name: LCP Chemicals Site, Brunswick GA
 Boring No: SW-64
 Diameter: 8 in
 Date: 08/07/2013 - 08/08/2013

Northing (ft): 432393.53
 Easting (ft): 861905.21
 Elevation (ft): 10.42
 Total Depth: 53.5 Ft

Driller: Groundwater Protection Inc
 Method: Mud Rotary
 Consultant: PARSONS
 Project No: 448517

Datum: NAVD88
 Coordinate System:
 NAD 1983 State Plane
 Georgia East / FIPS 1001

Depth Ft	Recov	Sample ID	Blow Count	PID (ppm)	Mercury (mg/m3)	USCS Code	Soil Description	Well Construction Diagram
45			6			SM	Gray fine to medium SAND, wet.	
			14					
			13	0.0	0.000		Greenish gray fine to medium SAND, little clay, cohesive, wet.	
			15			SM/CL		
			14					
			24					
			6	0.0	0.000		Light gray fine to medium SAND, no clay, wet.	
			16			SM		
			21					
			23					
50			7	0.0	0.000		Greenish gray CLAY interbedded with tan brown fine SAND, fishy odor bottom 6 inches over tan fine to medium sand, wet.	
			6			SM/CL		
			9					
			7					
			15	0.0	0.000		Light gray fine SAND, over 8 inches of gray SAND and CLAY, and gray weathered sandstone in tip, wet.	
			16			SM/CL		
			50/5					

53.5

Well Set at 52.5 ft.

BORING LOG



Site Name: LCP Chemicals Site, Brunswick GA
 Boring No: SW-65
 Diameter: 8 in
 Date: 08/12/2013

Northing (ft): 431513.80
 Easting (ft): 861477.74
 Elevation (ft): 10.15
 Total Depth: 50.08 Ft

Driller: Groundwater Protection Inc
 Method: Mud Rotary
 Consultant: Mutch Associates
 Project No: 448517

Datum: NAVD88
 Coordinate System:
 NAD 1983 State Plane
 Georgia East / FIPS 1001

Depth Ft	Recov	Sample ID	Blow Count	PID (ppm)	Mercury (mg/m3)	USCS Code	Soil Description	Well Construction Diagram
30							Brown gray drilling MUD, pH 7 to 8.	
35				7.8	0			
40			6	0	0	SM	Gray fine to coarse SAND, trace silt.	
			7					
			9					
			12			SM	Gray fine to coarse SAND, trace silt.	
			2	0	0	SM	Gray fine to coarse SAND, trace silt.	
			9					
			22					
			20			SM	Gray fine to coarse SAND, trace silt, layer 7 inch fine to medium sand, trace silt.	
			16	0	0			
45			17			SC	Gray fine to coarse SAND, little clayey silt, trace white shell fragments.	

BORING LOG



Site Name: LCP Chemicals Site, Brunswick GA
 Boring No: SW-65
 Diameter: 8 in
 Date: 08/12/2013

Northing (ft): 431513.80
 Easting (ft): 861477.74
 Elevation (ft): 10.15
 Total Depth: 50.08 Ft

Driller: Groundwater Protection Inc
 Method: Mud Rotary
 Consultant: Mutch Associates
 Project No: 448517

Datum: NAVD88
 Coordinate System:
 NAD 1983 State Plane
 Georgia East / FIPS 1001

Depth Ft	Recov	Sample ID	Blow Count	PID (ppm)	Mercury (mg/m3)	USCS Code	Soil Description	Well Construction Diagram
45	[Diagram showing recovery status]		20	0	0	SM	Gray fine to coarse SAND, trace silt, trace white shell fragments.	[Well Construction Diagram]
		28				SM	Gray fine to medium SAND, trace silt, trace white shell fragments.	
		9				SM	Gray fine to medium SAND, trace silt, trace white shell fragments.	
		20				SM	Gray fine to medium SAND, trace silt, trace white shell fragments.	
		26						
		28						
		10		0	0	SM	Gray fine to medium SAND, trace silt, trace white shell fragments.	
		13						
		15						
50.08				50			SM/R	

Well Set at 50 ft.

No recovery, spoon bouncing on formation.

Phase 2 Sparge Well Boring Logs

BORING LOG

Site Name: LCP Chemicals Site, Brunswick GA



Boring No: SW-66

Diameter: 8 Inches

Date: 09/04/2014

Northing (ft): 431554.12
 Easting (ft): 861478.48
 Elevation (ft): 10.09
 Total Depth: 50.2 Ft

Driller: Groundwater Protection Inc
 Method: Mud Rotary
 Consultant: Mutch Associates
 Project No: 448517

Datum: NAVD88
 Coordinate System:
 NAD 1983 State Plane
 Georgia East / FIPS 1001

Depth Ft	Recov	Sample ID	Blow Count	PID (ppm)	Mercury (mg/m3)	USCS Code	Soil Description	Well Construction Diagram
0							Hand cleared to 5 feet. Brown-gray SAND. 5-44 ft. pH=7, VOCs=0.0, Hg= 0.0.	
5						SM		
10				0.0	0.000			
15								

BORING LOG



Site Name: LCP Chemicals Site, Brunswick GA
 Boring No: SW-66
 Diameter: 8 Inches
 Date: 09/04/2014

Northing (ft): 431554.12
 Easting (ft): 861478.48
 Elevation (ft): 10.09
 Total Depth: 50.2 Ft

Driller: Groundwater Protection Inc
 Method: Mud Rotary
 Consultant: Mutch Associates
 Project No: 448517

Datum: NAVD88
 Coordinate System:
 NAD 1983 State Plane
 Georgia East / FIPS 1001

Depth Ft	Recov	Sample ID	Blow Count	PID (ppm)	Mercury (mg/m3)	USCS Code	Soil Description	Well Construction Diagram
30								
35				0.0	0.000			
40								
45		15-19-29-31		0.0	0.000	SM	Gray, fine-medium SAND, trace silt, trace shells.	

BORING LOG



Site Name: LCP Chemicals Site, Brunswick GA
 Boring No: SW-66
 Diameter: 8 Inches
 Date: 09/04/2014

Northing (ft): 431554.12
 Easting (ft): 861478.48
 Elevation (ft): 10.09
 Total Depth: 50.2 Ft

Driller: Groundwater Protection Inc
 Method: Mud Rotary
 Consultant: Mutch Associates
 Project No: 448517

Datum: NAVD88
 Coordinate System:
 NAD 1983 State Plane
 Georgia East / FIPS 1001

Depth Ft	Recov	Sample ID	Blow Count	PID (ppm)	Mercury (mg/m3)	USCS Code	Soil Description	Well Construction Diagram
45			15-19-29-31	0.0	0.000	SM	Gray, fine-medium SAND, trace silt, trace shells.	
			16-25-33-38	0.0	0.000	SM	As above	
			16-23-24-38	0.0	0.000	SM	Gray, fine-medium SAND, trace silt.	
50 50.2			50/2	0.0	0.000	BR	Variably cemented SANDSTONE	

Hand cleared to 5 ft, Refusal at 50.2 ft. Well set at 50 ft. (2 ft of screen).

BORING LOG

Site Name: LCP Chemicals Site, Brunswick GA



Boring No: SW-67

Diameter: 8 Inches

Date: 09/03/2015

Northing (ft): 431635.36
 Easting (ft): 861478.33
 Elevation (ft): 9.50
 Total Depth: 49.5 Ft

Driller: Groundwater Protection Inc
 Method: Mud Rotary
 Consultant: Mutch Associates
 Project No: 448517

Datum: NAVD88
 Coordinate System:
 NAD 1983 State Plane
 Georgia East / FIPS 1001

Depth Ft	Recov	Sample ID	Blow Count	PID (ppm)	Mercury (mg/m3)	USCS Code	Soil Description	Well Construction Diagram
0							Hand cleared to 5 feet. 5-44 ft. pH= 7, VOC= 0.0, Hg= 0.0	
5						SM		
10				0.0	0.000			
15								

BORING LOG



Site Name: LCP Chemicals Site, Brunswick GA
 Boring No: SW-67
 Diameter: 8 Inches
 Date: 09/03/2015

Northing (ft): 431635.36
 Easting (ft): 861478.33
 Elevation (ft): 9.50
 Total Depth: 49.5 Ft

Driller: Groundwater Protection Inc
 Method: Mud Rotary
 Consultant: Mutch Associates
 Project No: 448517

Datum: NAVD88
 Coordinate System:
 NAD 1983 State Plane
 Georgia East / FIPS 1001

Depth Ft	Recov	Sample ID	Blow Count	PID (ppm)	Mercury (mg/m3)	USCS Code	Soil Description	Well Construction Diagram
30								
35				0.0	0.000			
40								
45		13-11-14-19		0.0	0.000	SM	Gray, fine-medium SAND, trace silt, trace shells.	

BORING LOG



Site Name: LCP Chemicals Site, Brunswick GA
 Boring No: SW-67
 Diameter: 8 Inches
 Date: 09/03/2015

Northing (ft): 431635.36
 Easting (ft): 861478.33
 Elevation (ft): 9.50
 Total Depth: 49.5 Ft

Driller: Groundwater Protection Inc
 Method: Mud Rotary
 Consultant: Mutch Associates
 Project No: 448517

Datum: NAVD88
 Coordinate System:
 NAD 1983 State Plane
 Georgia East / FIPS 1001

Depth Ft	Recov	Sample ID	Blow Count	PID (ppm)	Mercury (mg/m3)	USCS Code	Soil Description	Well Construction Diagram
45	RECOVERED		13-11-14-19	0.0	0.000	SM	Gray, fine-medium SAND, trace silt, trace shells.	
			16-24-26-32	0.0	0.000	SM	As above.	
			11-39-50/6	0.0	0.000	SM-BR	As above over gray fine-medium SAND, some silt, trace pieces of mudstone, variably cemented sandstone Bedrock in tip.	
49.5								

Hand cleared to 5 ft, Refusal at 49.5 ft. Well set at 48.5 ft. (2 ft of screen).

BORING LOG



Site Name: LCP Chemicals Site, Brunswick GA
 Boring No: SW-68
 Diameter: 8 Inches
 Date: 09/03/2014

Northing (ft): 431714.34
 Easting (ft): 861478.08
 Elevation (ft): 9.08
 Total Depth: 51.0 Ft

Driller: Groundwater Protection Inc
 Method: Mud Rotary
 Consultant: Mutch Associates
 Project No: 448517

Datum: NAVD88
 Coordinate System:
 NAD 1983 State Plane
 Georgia East / FIPS 1001

Depth Ft	Recov	Sample ID	Blow Count	PID (ppm)	Mercury (mg/m3)	USCS Code	Soil Description	Well Construction Diagram
30								
35				0.0	0.000			
40								
45		22-23-27-30		0.0	0.000	SM	Gray fine-medium SAND, trace silt, trace shells.	

BORING LOG



Site Name: LCP Chemicals Site, Brunswick GA
 Boring No: SW-68
 Diameter: 8 Inches
 Date: 09/03/2014

Northing (ft): 431714.34
 Easting (ft): 861478.08
 Elevation (ft): 9.08
 Total Depth: 51.0 Ft

Driller: Groundwater Protection Inc
 Method: Mud Rotary
 Consultant: Mutch Associates
 Project No: 448517

Datum: NAVD88
 Coordinate System:
 NAD 1983 State Plane
 Georgia East / FIPS 1001

Depth Ft	Recov	Sample ID	Blow Count	PID (ppm)	Mercury (mg/m3)	USCS Code	Soil Description	Well Construction Diagram
45			22-23-27-30	0.0	0.000	SM	Gray fine-medium SAND, trace silt, trace shells.	
						As above		
			21-23-28-38	0.0	0.000	SM		
			18-16-X-X	0.0	0.000	SM		
50			50/6	0.0	0.000	SM-BR	Grey, fine to coarse SAND, some silt, variably cemented SANDSTONE bedrock in tip of spoon.	
51.0								

Hand cleared to 5 ft, Refusal at 51 ft. Well set at 51 ft. (2 ft of screen).

BORING LOG



Site Name: LCP Chemicals Site, Brunswick GA
 Boring No: SW-69
 Diameter: 8 Inches
 Date: 09/02/2014 - 09/03/2014

Northing (ft): 431794.01
 Easting (ft): 861478.05
 Elevation (ft): 9.49
 Total Depth: 51.5 Ft

Driller: Groundwater Protection Inc
 Method: Mud Rotary
 Consultant: Mutch Associates
 Project No: 448517

Datum: NAVD88
 Coordinate System:
 NAD 1983 State Plane
 Georgia East / FIPS 1001

Depth Ft	Recov	Sample ID	Blow Count	PID (ppm)	Mercury (mg/m3)	USCS Code	Soil Description	Well Construction Diagram
30								
35				0.0	0.000			
40								
45		17-25-33-34		0.0	0.000	SM	Gray, fine-medium SAND, trace silt, trace shells.	

BORING LOG



Site Name: LCP Chemicals Site, Brunswick GA
 Boring No: SW-69
 Diameter: 8 Inches
 Date: 09/02/2014 - 09/03/2014

Northing (ft): 431794.01
 Easting (ft): 861478.05
 Elevation (ft): 9.49
 Total Depth: 51.5 Ft

Driller: Groundwater Protection Inc
 Method: Mud Rotary
 Consultant: Mutch Associates
 Project No: 448517

Datum: NAVD88
 Coordinate System:
 NAD 1983 State Plane
 Georgia East / FIPS 1001

Depth Ft	Recov	Sample ID	Blow Count	PID (ppm)	Mercury (mg/m3)	USCS Code	Soil Description	Well Construction Diagram
45			17-25-33-34	0.0	0.000	SM	Gray, fine-medium SAND, trace silt, trace shells.	
			30-30-50+	0.0	0.000	SM	Gray, fine to coarse SAND, trace silt, trace shells at bottom.	
			17-16-17-X	0.0	0.000	SM	Gray, fine to medium SAND, trace silt, trace shells.	
50			13-20-50/2	0.0	0.000	SM-BR	Gray fine-medium SAND, trace-little silt, trace shells. Variably cemented SANDSTONE in tip.	
51.5								

Hand cleared to 5 ft, Refusal at 51.5 ft. Well set at 51 ft. (2 ft of screen).

BORING LOG



Site Name: LCP Chemicals Site, Brunswick GA
 Boring No: SW-70
 Diameter: 8 Inches
 Date: 09/10/2014

Northing (ft): 431874.53
 Easting (ft): 861477.72
 Elevation (ft): 8.44
 Total Depth: 48.9 Ft

Driller: Groundwater Protection Inc
 Method: Mud Rotary
 Consultant: PARSONS
 Project No: 448517

Datum: NAVD88
 Coordinate System:
 NAD 1983 State Plane
 Georgia East / FIPS 1001

Depth Ft	Recov	Sample ID	Blow Count	PID (ppm)	Mercury (mg/m3)	USCS Code	Soil Description	Well Construction Diagram
45			7-9-17-17	0.0	0.000	SC	Wet, fine-medium SAND, trace clay, widely scattered thin clay lenses. Hg= 0.0 mg/m3, VOCs= 0.0 ppm	
			3-4-7-6	0.0	0.000	SM	Wet, fine SAND, little medium sand, trace clay. Hg= 0.0 mg/m3, VOCs= 0.0 ppm	
			30-50/5	0.0	0.000	SM	Wet, fine-medium SAND, over gray fine sand, trace fine gravel, trace shells, trace silt. Hg= 0.0 mg/m3 VOCs= 0.0 ppm	
48.9								

Hand cleared to 5 ft, Refusal at 48.9 ft. Well set at 48.5 ft. (2 ft of screen).

BORING LOG



Site Name: LCP Chemicals Site, Brunswick GA
 Boring No: SW-71
 Diameter: 8 Inches
 Date: 09/05/2015

Northing (ft): 431434.05
 Easting (ft): 861547.33
 Elevation (ft): 9.87
 Total Depth: 49.75 Ft

Driller: Groundwater Protection Inc
 Method: Mud Rotary
 Consultant: PARSONS
 Project No: 448517

Datum: NAVD88
 Coordinate System:
 NAD 1983 State Plane
 Georgia East / FIPS 1001

Depth Ft	Recov	Sample ID	Blow Count	PID (ppm)	Mercury (mg/m3)	USCS Code	Soil Description	Well Construction Diagram
30								
35								
40								
45		6-3-7-16		0.0	0.000	SM	Wet, gray medium to fine SAND, little shells, trace silt. Hg=0.0 VOCs= 0.0	

BORING LOG



Site Name: LCP Chemicals Site, Brunswick GA
 Boring No: SW-71
 Diameter: 8 Inches
 Date: 09/05/2015

Northing (ft): 431434.05
 Easting (ft): 861547.33
 Elevation (ft): 9.87
 Total Depth: 49.75 Ft

Driller: Groundwater Protection Inc
 Method: Mud Rotary
 Consultant: PARSONS
 Project No: 448517

Datum: NAVD88
 Coordinate System:
 NAD 1983 State Plane
 Georgia East / FIPS 1001

Depth Ft	Recov	Sample ID	Blow Count	PID (ppm)	Mercury (mg/m3)	USCS Code	Soil Description	Well Construction Diagram
45			6-3-7-16	0.0	0.000	SM	Wet, gray medium to fine SAND, little shells, trace silt. Hg=0.0 VOCs= 0.0	
			13-24-40-50	0.0	0.000	SM	As above. Hg= 0.0 VOCs=0.0	
			13-15-24-50/3	0.0	0.000	SM	As above, less shells (trace) over black/gray medium to fine SAND, little silt, little coarse sand. Hg= 0.0 VOCs= 0.0.	
49.75								

Hand cleared to 5 ft, Refusal at 49.75 ft. Well set at 49.5 ft. (2 ft of screen).

BORING LOG



Site Name: LCP Chemicals Site, Brunswick GA
 Boring No: SW-72
 Diameter: 8 Inches
 Date: 09/04/2014

Northing (ft): 431514.43
 Easting (ft): 861547.22
 Elevation (ft): 9.53
 Total Depth: 50.0 Ft

Driller: Groundwater Protection Inc
 Method: Mud Rotary
 Consultant: PARSONS
 Project No: 448517

Datum: NAVD88
 Coordinate System:
 NAD 1983 State Plane
 Georgia East / FIPS 1001

Depth Ft	Recov	Sample ID	Blow Count	PID (ppm)	Mercury (mg/m3)	USCS Code	Soil Description	Well Construction Diagram
30								
35				0.0	0.000			
40				0.0	0.000			
45		10-10-14-16		0.0	0.000	SM	Wet, gray medium to fine SAND, little to trace silt, trace shells. Hg= 0.0 mg/m3 VOCs= 0.0, pH= 9	

BORING LOG



Site Name: LCP Chemicals Site, Brunswick GA
 Boring No: SW-72
 Diameter: 8 Inches
 Date: 09/04/2014

Northing (ft): 431514.43
 Easting (ft): 861547.22
 Elevation (ft): 9.53
 Total Depth: 50.0 Ft

Driller: Groundwater Protection Inc
 Method: Mud Rotary
 Consultant: PARSONS
 Project No: 448517

Datum: NAVD88
 Coordinate System:
 NAD 1983 State Plane
 Georgia East / FIPS 1001

Depth Ft	Recov	Sample ID	Blow Count	PID (ppm)	Mercury (mg/m3)	USCS Code	Soil Description	Well Construction Diagram
45			10-10-14-16	0.0	0.000	SM	Wet, gray medium to fine SAND, little to trace silt, trace shells. Hg= 0.0 mg/m3 VOCs= 0.0, pH= 9	
			6-15-20-23	0.0	0.000	SM	As above	
			10-17-15-50/6	0.0	0.000	SM	As above 48-48.5. Weathered bedrock, dark gray, medium to fine SAND, some silt, little coarse gravel. Hg= 0.0 mg/m3 VOCs= 0.0	

50.0

Hand cleared to 5 ft, Refusal at 50 ft. Well set at 49 ft. (2 ft of screen).

BORING LOG



Site Name: LCP Chemicals Site, Brunswick GA
 Boring No: SW-73
 Diameter: 8 Inches
 Date: 09/04/2014

Northing (ft): 431594.87
 Easting (ft): 861546.61
 Elevation (ft): 9.43
 Total Depth: 50.75 ft

Driller: Groundwater Protection Inc
 Method: Mud Rotary
 Consultant: PARSONS
 Project No: 448517

Datum: NAVD88
 Coordinate System:
 NAD 1983 State Plane
 Georgia East / FIPS 1001

Depth ft	Recov	Sample ID	Blow Count	PID (ppm)	Mercury (mg/m3)	USCS Code	Soil Description	Well Construction Diagram
30								
35				0.0	0.000			
40				0.0	0.000			
45		13-7-7-6		0.0	0.000	SM	Wet, gray fine to medium SAND, trace silt and clay, trace shells.	

BORING LOG



Site Name: LCP Chemicals Site, Brunswick GA
 Boring No: SW-73
 Diameter: 8 Inches
 Date: 09/04/2014

Northing (ft): 431594.87
 Easting (ft): 861546.61
 Elevation (ft): 9.43
 Total Depth: 50.75 ft

Driller: Groundwater Protection Inc
 Method: Mud Rotary
 Consultant: PARSONS
 Project No: 448517

Datum: NAVD88
 Coordinate System:
 NAD 1983 State Plane
 Georgia East / FIPS 1001

Depth ft	Recov	Sample ID	Blow Count	PID (ppm)	Mercury (mg/m3)	USCS Code	Soil Description	Well Construction Diagram
45			13-7-7-6	0.0	0.000	SM	Wet, gray fine to medium SAND, trace silt and clay, trace shells.	
			3-2-3-5	0.0	0.000	SM	As above	
			4-3-5-6	0.0	0.000	SM	Wet gray, fine to medium SAND, trace-little silt.	
50			40-50/3	0.0	0.000	SM	Wet brown-gray, fine to medium SAND, little coarse sand, some silt.	
50.75								

Hand cleared to 5 ft, Refusal at 50.75 ft. Well set at 50 ft. (2 ft of screen).

BORING LOG



Site Name: LCP Chemicals Site, Brunswick GA
 Boring No: SW-74
 Diameter: 8 Inches
 Date: 09/03/2014

Northing (ft): 431674.12
 Easting (ft): 861547.67
 Elevation (ft): 9.20
 Total Depth: 52.0 Ft

Driller: Groundwater Protection Inc
 Method: Mud Rotary
 Consultant: PARSONS
 Project No: 448517

Datum: NAVD88
 Coordinate System:
 NAD 1983 State Plane
 Georgia East / FIPS 1001

Depth Ft	Recov	Sample ID	Blow Count	PID (ppm)	Mercury (mg/m3)	USCS Code	Soil Description	Well Construction Diagram
30								
35				0.0	0.000			
40								
45		14-24-28-33				SM	Wet, gray fine to medium SAND, trace to little silt, little shells.	

BORING LOG



Site Name: LCP Chemicals Site, Brunswick GA
 Boring No: SW-74
 Diameter: 8 Inches
 Date: 09/03/2014

Northing (ft): 431674.12
 Easting (ft): 861547.67
 Elevation (ft): 9.20
 Total Depth: 52.0 Ft

Driller: Groundwater Protection Inc
 Method: Mud Rotary
 Consultant: PARSONS
 Project No: 448517

Datum: NAVD88
 Coordinate System:
 NAD 1983 State Plane
 Georgia East / FIPS 1001

Depth Ft	Recov	Sample ID	Blow Count	PID (ppm)	Mercury (mg/m3)	USCS Code	Soil Description	Well Construction Diagram
45			14-24-28-33			SM	Wet, gray fine to medium SAND, trace to little silt, little shells.	
			11-21-44-48			SM	As above	
			20-24-30-28			SM	As above	
50			13-16-15-50/5			SM	Wet-moist, black-gray fine-medium SAND, some silt, trace coarse sand, lense of silt.	
52.0								

Hand cleared to 5 ft, Refusal at 52 ft. Well set at 51.5 ft. (2 ft of screen).

BORING LOG

Page 1 of 4



Site Name: LCP Chemicals Site, Brunswick GA

Boring No: SW-75

Diameter: 8 Inches

Date: 09/03/2014

Northing (ft): 431752.81
 Easting (ft): 861547.61
 Elevation (ft): 8.92
 Total Depth: 50.0 Ft

Driller: Groundwater Protection Inc
 Method: Mud Rotary
 Consultant: PARSONS
 Project No: 448517

Datum: NAVD88
 Coordinate System:
 NAD 1983 State Plane
 Georgia East / FIPS 1001

Depth Ft	Recov	Sample ID	Blow Count	PID (ppm)	Mercury (mg/m3)	USCS Code	Soil Description	Well Construction Diagram
0							Hand cleared to 5 feet. pH= 8 Mud rotary to 44 feet. pH= 8.	
5						SM		
10								
15								

BORING LOG



Site Name: LCP Chemicals Site, Brunswick GA
 Boring No: SW-75
 Diameter: 8 Inches
 Date: 09/03/2014

Northing (ft): 431752.81
 Easting (ft): 861547.61
 Elevation (ft): 8.92
 Total Depth: 50.0 Ft

Driller: Groundwater Protection Inc
 Method: Mud Rotary
 Consultant: PARSONS
 Project No: 448517

Datum: NAVD88
 Coordinate System:
 NAD 1983 State Plane
 Georgia East / FIPS 1001

Depth Ft	Recov	Sample ID	Blow Count	PID (ppm)	Mercury (mg/m3)	USCS Code	Soil Description	Well Construction Diagram
30								
35								
40								
45		17-41-42-47		0.0	0.000	SM	Wet, gray, fine-medium SAND, trace-little silt, little shells.	

BORING LOG



Site Name: LCP Chemicals Site, Brunswick GA
 Boring No: SW-75
 Diameter: 8 Inches
 Date: 09/03/2014

Northing (ft): 431752.81
 Easting (ft): 861547.61
 Elevation (ft): 8.92
 Total Depth: 50.0 Ft

Driller: Groundwater Protection Inc
 Method: Mud Rotary
 Consultant: PARSONS
 Project No: 448517

Datum: NAVD88
 Coordinate System:
 NAD 1983 State Plane
 Georgia East / FIPS 1001

Depth Ft	Recov	Sample ID	Blow Count	PID (ppm)	Mercury (mg/m3)	USCS Code	Soil Description	Well Construction Diagram
45			17-41-42-47	0.0	0.000	SM	Wet, gray, fine-medium SAND, trace-little silt, little shells.	
			36-38-36-31	0.0	0.000	SM	As above	
			18-20-29-50	0.0	0.000	SM	As above	
50.0								

Hand cleared to 5 ft, Refusal at 50 ft. Well set at 50 ft. (3 ft of screen).

BORING LOG



Site Name: LCP Chemicals Site, Brunswick GA
 Boring No: SW-76
 Diameter: 8 Inches
 Date: 09/02/2014 - 09/03/2014

Northing (ft): 431834.99
 Easting (ft): 861545.73
 Elevation (ft): 8.87
 Total Depth: 47.75 Ft

Driller: Groundwater Protection Inc
 Method: Mud Rotary
 Consultant: PARSONS
 Project No: 448517

Datum: NAVD88
 Coordinate System:
 NAD 1983 State Plane
 Georgia East / FIPS 1001

Depth Ft	Recov	Sample ID	Blow Count	PID (ppm)	Mercury (mg/m3)	USCS Code	Soil Description	Well Construction Diagram
30								
35				0.0	0.000			
40				0.0	0.000			
45		6-12-13-48		0.0	0.000	SM	Wet, gray , fine-medium SAND, little shells, trace silt. Shells increasing with depth.	

BORING LOG



Site Name: LCP Chemicals Site, Brunswick GA
 Boring No: SW-76
 Diameter: 8 Inches
 Date: 09/02/2014 - 09/03/2014

Northing (ft): 431834.99
 Easting (ft): 861545.73
 Elevation (ft): 8.87
 Total Depth: 47.75 Ft

Driller: Groundwater Protection Inc
 Method: Mud Rotary
 Consultant: PARSONS
 Project No: 448517

Datum: NAVD88
 Coordinate System:
 NAD 1983 State Plane
 Georgia East / FIPS 1001

Depth Ft	Recov	Sample ID	Blow Count	PID (ppm)	Mercury (mg/m3)	USCS Code	Soil Description	Well Construction Diagram
45			6-12-13-48	0.0	0.000	SM	Wet, gray, fine-medium SAND, little shells, trace silt. Shells increasing with depth.	
			40-42-60-60/0	0.0	0.000	SM	As above.	

47.75

Hand cleared to 5 ft, Refusal at 47.75 ft. Well set at 47.75 ft. (3 ft of screen).

BORING LOG



Site Name: LCP Chemicals Site, Brunswick GA
 Boring No: SW-77
 Diameter: 8 Inches
 Date: 08/26/2014

Northing (ft): 431915.06
 Easting (ft): 861545.71
 Elevation (ft): 8.75
 Total Depth: 48.3 Ft

Driller: Groundwater Protection Inc
 Method: Mud Rotary
 Consultant: Mutch Associates
 Project No: 448517

Datum: NAVD88
 Coordinate System:
 NAD 1983 State Plane
 Georgia East / FIPS 1001

Depth Ft	Recov	Sample ID	Blow Count	PID (ppm)	Mercury (mg/m3)	USCS Code	Soil Description	Well Construction Diagram
30								
35				0.0	0.000			
40								
45		50-64-		0.0	0.000	SM	Gray fine-medium SAND, trace silt, trace little shells. Mud rotary 45-46 ft.	

BORING LOG



Site Name: LCP Chemicals Site, Brunswick GA
 Boring No: SW-77
 Diameter: 8 Inches
 Date: 08/26/2014

Northing (ft): 431915.06
 Easting (ft): 861545.71
 Elevation (ft): 8.75
 Total Depth: 48.3 Ft

Driller: Groundwater Protection Inc
 Method: Mud Rotary
 Consultant: Mutch Associates
 Project No: 448517

Datum: NAVD88
 Coordinate System:
 NAD 1983 State Plane
 Georgia East / FIPS 1001

Depth Ft	Recov	Sample ID	Blow Count	PID (ppm)	Mercury (mg/m3)	USCS Code	Soil Description	Well Construction Diagram
45			50-64-	0.0	0.000	SM	Gray fine-medium SAND, trace silt, trace little shells. Mud rotary 45-46 ft.	
			51-48-58-	0.0	0.000	SM	Gray fine-medium SAND, trace silt, trace-little shells.	
48.3			50/4	0.0	0.000	SM-BR	Gray, fine-medium SAND. Sandstone bedrock in tip of spoon.	

Hand cleared to 5 ft, Refusal at 48.3 ft. Well set at 48 ft. (2 ft. of screen).

BORING LOG



Site Name: LCP Chemicals Site, Brunswick GA
 Boring No: SW-78
 Diameter: 8 Inches
 Date: 09/04/2014 - 09/05/2014

Northing (ft): 431394.06
 Easting (ft): 861617.02
 Elevation (ft): 10.10
 Total Depth: 50.0 Ft

Driller: Groundwater Protection Inc
 Method: Mud Rotary
 Consultant: Mutch Associates
 Project No: 448517

Datum: NAVD88
 Coordinate System:
 NAD 1983 State Plane
 Georgia East / FIPS 1001

Depth Ft	Recov	Sample ID	Blow Count	PID (ppm)	Mercury (mg/m3)	USCS Code	Soil Description	Well Construction Diagram
30								
35				0.0	0.000			
40								
45		14-17-23-21		0.0	0.000	SM	Gray, fine-medium SAND, trace silt 44-45.5 ft. Gray silt and clay , little sand 45.5-46 ft.	

BORING LOG



Site Name: LCP Chemicals Site, Brunswick GA
 Boring No: SW-78
 Diameter: 8 Inches
 Date: 09/04/2014 - 09/05/2014

Northing (ft): 431394.06
 Easting (ft): 861617.02
 Elevation (ft): 10.10
 Total Depth: 50.0 Ft

Driller: Groundwater Protection Inc
 Method: Mud Rotary
 Consultant: Mutch Associates
 Project No: 448517

Datum: NAVD88
 Coordinate System:
 NAD 1983 State Plane
 Georgia East / FIPS 1001

Depth Ft	Recov	Sample ID	Blow Count	PID (ppm)	Mercury (mg/m3)	USCS Code	Soil Description	Well Construction Diagram
45			14-17-23-21	0.0	0.000	SM	Gray, fine-medium SAND, trace silt 44-45.5 ft. Gray silt and clay , little sand 45.5-46 ft.	
			12-17-20-18	0.0	0.000	ML	As above 46-46.5 ft. 46.5 -47 ft. Gray fine-medium SAND, SILT, and CLAY. 47-48 ft. Gray fine to medium SAND, trace silt.	
			13-25-35-50	0.0	0.000	SM	Gray fine-medium SAND, trace silt, trace shells, trace mudstone bedrock in bottom of sample.	
50.0								

Hand cleared to 5 ft, Refusal at 50 ft. Well set at 50 ft. (2 ft of screen).

BORING LOG



Site Name: LCP Chemicals Site, Brunswick GA
 Boring No: SW-79
 Diameter: 8 Inches
 Date: 09/04/2014

Northing (ft): 431482.47
 Easting (ft): 861619.34
 Elevation (ft): 9.90
 Total Depth: 51.7 Ft

Driller: Groundwater Protection Inc
 Method: Mud Rotary
 Consultant: Mutch Associates
 Project No: 448517

Datum: NAVD88
 Coordinate System:
 NAD 1983 State Plane
 Georgia East / FIPS 1001

Depth Ft	Recov	Sample ID	Blow Count	PID (ppm)	Mercury (mg/m3)	USCS Code	Soil Description	Well Construction Diagram
45			8-8-11-17	0.0	0.000	ML	Gray SILT and CLAY, little fine to medium sand. Lower sample gray fine-medium SAND, trace silt.	
			12-18-21-22	0.0	0.000	SM	Gray, fine-medium SAND, trace silt.	
50			12-17-18-17	0.0	0.000	SM	As above.	
			30-50/2	0.0	0.000	BR	Sand as above. 1 inch of variably cemented SANDSTONE.	
51.7								

Hand cleared to 5 ft, Refusal at 51.7 ft. Well set at 51.5 ft. (2 ft of screen).

BORING LOG



Site Name: LCP Chemicals Site, Brunswick GA
 Boring No: SW-80
 Diameter: 8 Inches
 Date: 09/05/2014

Northing (ft): 431555.62
 Easting (ft): 861614.35
 Elevation (ft): 10.23
 Total Depth: 51.5 Ft

Driller: Groundwater Protection Inc
 Method: Mud Rotary
 Consultant: Mutch Associates
 Project No: 448517

Datum: NAVD88
 Coordinate System:
 NAD 1983 State Plane
 Georgia East / FIPS 1001

Depth Ft	Recov	Sample ID	Blow Count	PID (ppm)	Mercury (mg/m3)	USCS Code	Soil Description	Well Construction Diagram
45				0.0	0.000			
			25-26-34-34	0.0	0.000	SM	Gray, fine to medium SAND, trace silt, trace shells.	
			17-20-29-27	0.0	0.000	SM	As above	
50			17-25-50/6	0.0	0.000	SM	As above, trace mudstone near bottom of sample.	
51.5								

Hand cleared to 5 ft, Refusal at 51.5 ft. Well set at 51.5 ft. (2 ft of screen).

BORING LOG



Site Name: LCP Chemicals Site, Brunswick GA
 Boring No: SW-81
 Diameter: 8 Inches
 Date: 09/05/2014 - 09/06/2014

Northing (ft): 431634.82
 Easting (ft): 861617.18
 Elevation (ft): 9.92
 Total Depth: 50.8 Ft

Driller: Groundwater Protection Inc
 Method: Mud Rotary
 Consultant: Mutch Associates
 Project No: 448517

Datum: NAVD88
 Coordinate System:
 NAD 1983 State Plane
 Georgia East / FIPS 1001

Depth Ft	Recov	Sample ID	Blow Count	PID (ppm)	Mercury (mg/m3)	USCS Code	Soil Description	Well Construction Diagram
30								
35								
40				0.0	0.000			
45								

BORING LOG



Site Name: LCP Chemicals Site, Brunswick GA
 Boring No: SW-81
 Diameter: 8 Inches
 Date: 09/05/2014 - 09/06/2014

Northing (ft): 431634.82
 Easting (ft): 861617.18
 Elevation (ft): 9.92
 Total Depth: 50.8 Ft

Driller: Groundwater Protection Inc
 Method: Mud Rotary
 Consultant: Mutch Associates
 Project No: 448517

Datum: NAVD88
 Coordinate System:
 NAD 1983 State Plane
 Georgia East / FIPS 1001

Depth Ft	Recov	Sample ID	Blow Count	PID (ppm)	Mercury (mg/m3)	USCS Code	Soil Description	Well Construction Diagram
45				0.0	0.000			
			50+	0.0	0.000	SM	Gray, fine to medium SAND, trace silt, trace shells. Very dense at bottom. No recovery.	
		14-13-16-17		0.0	0.000	SM	Gray, fine to medium SAND, trace silt, trace shells.	
50		20-50/4		0.0	0.000	SM-BR	Gray fine to medium SAND, trace silt, trace shells. Bottom 4 inches variably cemented SANDSTONE.	
50.8								

Hand cleared to 5 ft, Refusal at 50.8 ft. Well set at 50.5 ft. (2 ft of screen).

BORING LOG



Site Name: LCP Chemicals Site, Brunswick GA
 Boring No: SW-82
 Diameter: 8 Inches
 Date: 09/06/2014

Northing (ft): 431714.45
 Easting (ft): 861613.43
 Elevation (ft): 9.72
 Total Depth: 51.1 Ft

Driller: Groundwater Protection Inc
 Method: Mud Rotary
 Consultant: Mutch Associates
 Project No: 448517

Datum: NAVD88
 Coordinate System:
 NAD 1983 State Plane
 Georgia East / FIPS 1001

Depth Ft	Recov	Sample ID	Blow Count	PID (ppm)	Mercury (mg/m3)	USCS Code	Soil Description	Well Construction Diagram
30								
35				0.0	0.000			
40								
45			9-10-50/6	0.0	0.000	SM	Gray, fine to medium SAND, trace silt, trace shells.	

BORING LOG



Site Name: LCP Chemicals Site, Brunswick GA
 Boring No: SW-82
 Diameter: 8 Inches
 Date: 09/06/2014

Northing (ft): 431714.45
 Easting (ft): 861613.43
 Elevation (ft): 9.72
 Total Depth: 51.1 Ft

Driller: Groundwater Protection Inc
 Method: Mud Rotary
 Consultant: Mutch Associates
 Project No: 448517

Datum: NAVD88
 Coordinate System:
 NAD 1983 State Plane
 Georgia East / FIPS 1001

Depth Ft	Recov	Sample ID	Blow Count	PID (ppm)	Mercury (mg/m3)	USCS Code	Soil Description	Well Construction Diagram
45			9-10-50/6	0.0	0.000	SM	Gray, fine to medium SAND, trace silt, trace shells.	
			49-50+22-29	0.0	0.000	SM	As above	
			33-23-25-29	0.0	0.000	SM	As above	
50			34-X-50/1	0.0	0.000	SM	As above. Bottom 2 inches variably cemented SANDSTONE.	
51.1								

Hand cleared to 5 ft, Refusal at 51.1 ft. Well set at 51 ft. (2 ft of screen).

BORING LOG



Site Name: LCP Chemicals Site, Brunswick GA
 Boring No: SW-83
 Diameter: 8 Inches
 Date: 09/06/2014

Northing (ft): 431795.22
 Easting (ft): 861619.54
 Elevation (ft): 9.32
 Total Depth: 45.5 Ft

Driller: Groundwater Protection Inc
 Method: Mud Rotary
 Consultant: Mutch Associates
 Project No: 448517

Datum: NAVD88
 Coordinate System:
 NAD 1983 State Plane
 Georgia East / FIPS 1001

Depth Ft	Recov	Sample ID	Blow Count	PID (ppm)	Mercury (mg/m3)	USCS Code	Soil Description	Well Construction Diagram
30								
35				0.0	0.000			
40								
45			4-50+ -50/6	0.0	0.000	SM-BR	Gray, fine to medium SAND, trace silt, trace shells, very dense. Trace of SANDSTONE in shoe.	

BORING LOG



Site Name: LCP Chemicals Site, Brunswick GA
 Boring No: SW-83
 Diameter: 8 Inches
 Date: 09/06/2014

Northing (ft): 431795.22
 Easting (ft): 861619.54
 Elevation (ft): 9.32
 Total Depth: 45.5 Ft

Driller: Groundwater Protection Inc
 Method: Mud Rotary
 Consultant: Mutch Associates
 Project No: 448517

Datum: NAVD88
 Coordinate System:
 NAD 1983 State Plane
 Georgia East / FIPS 1001

Depth Ft	Recov	Sample ID	Blow Count	PID (ppm)	Mercury (mg/m3)	USCS Code	Soil Description	Well Construction Diagram
45 45.5			4-50+50/6	0.0	0.000	SM-BR	Gray, fine to medium SAND, trace silt, trace shells, very dense. Trace of SANDSTONE in shoe.	

Hand cleared to 5 ft, Refusal at 45.5 ft. Well set at 45.5 ft. (2 ft of screen).

BORING LOG



Site Name: LCP Chemicals Site, Brunswick GA
 Boring No: SW-84
 Diameter: 8 Inches
 Date: 08/26/2014

Northing (ft): 431875.68
 Easting (ft): 861616.18
 Elevation (ft): 9.13
 Total Depth: 48.5 Ft

Driller: Groundwater Protection Inc
 Method: Mud Rotary
 Consultant: Mutch Associates
 Project No: 448517

Datum: NAVD88
 Coordinate System:
 NAD 1983 State Plane
 Georgia East / FIPS 1001

Depth Ft	Recov	Sample ID	Blow Count	PID (ppm)	Mercury (mg/m3)	USCS Code	Soil Description	Well Construction Diagram
30							Drilling with mud rotary, pH= 8.	
35				0.0	0.000			
40								
45		4-8-12-17		0.0	0.000	SM	Gray fine-medium SAND, little silty clay, trace silt.	

BORING LOG



Site Name: LCP Chemicals Site, Brunswick GA
 Boring No: SW-84
 Diameter: 8 Inches
 Date: 08/26/2014

Northing (ft): 431875.68
 Easting (ft): 861616.18
 Elevation (ft): 9.13
 Total Depth: 48.5 Ft

Driller: Groundwater Protection Inc
 Method: Mud Rotary
 Consultant: Mutch Associates
 Project No: 448517

Datum: NAVD88
 Coordinate System:
 NAD 1983 State Plane
 Georgia East / FIPS 1001

Depth Ft	Recov	Sample ID	Blow Count	PID (ppm)	Mercury (mg/m3)	USCS Code	Soil Description	Well Construction Diagram
45			4-8-12-17	0.0	0.000	SM	Gray fine-medium SAND, little silty clay, trace silt.	
			12-50+	0.0	0.000	SM	Gray fine-medium SAND, trace silt. Mud rotary to 48 feet.	
48.5			50/6	0.0	0.000	SM	Gray fine-medium SAND, trace silt, trace shells. Piece of bedrock in tip of split spoon.	

Hand cleared to 5 ft, Refusal at 48.5 ft. Well set at 48.5 ft. (2 ft of screen).

BORING LOG



Site Name: LCP Chemicals Site, Brunswick GA
 Boring No: SW-85
 Diameter: 8 Inches
 Date: 08/26/2014

Northing (ft): 431954.78
 Easting (ft): 861614.76
 Elevation (ft): 9.15
 Total Depth: 49.6 Ft

Driller: Groundwater Protection Inc
 Method: Mud Rotary
 Consultant: PARSONS
 Project No: 448517

Datum: NAVD88
 Coordinate System:
 NAD 1983 State Plane
 Georgia East / FIPS 1001

Depth Ft	Recov	Sample ID	Blow Count	PID (ppm)	Mercury (mg/m3)	USCS Code	Soil Description	Well Construction Diagram
30								
35				0.0				
40								
45		6-6-8-15		0.0		SM	Wet, greenish gray, fine-medium SAND over dense fine SAND, little silt, little clay, trace shells.	

BORING LOG



Site Name: LCP Chemicals Site, Brunswick GA
 Boring No: SW-85
 Diameter: 8 Inches
 Date: 08/26/2014

Northing (ft): 431954.78
 Easting (ft): 861614.76
 Elevation (ft): 9.15
 Total Depth: 49.6 Ft

Driller: Groundwater Protection Inc
 Method: Mud Rotary
 Consultant: PARSONS
 Project No: 448517

Datum: NAVD88
 Coordinate System:
 NAD 1983 State Plane
 Georgia East / FIPS 1001

Depth Ft	Recov	Sample ID	Blow Count	PID (ppm)	Mercury (mg/m3)	USCS Code	Soil Description	Well Construction Diagram
45			6-6-8-15	0.0		SM	Wet, greenish gray, fine-medium SAND over dense fine SAND, little silt, little clay, trace shells.	
			7-8-8-13	0.0		SM	Wet, greenish gray, fine-medium SAND, trace-little shells, trace silt. pH=7.5	
			20-33-28-50/1	0.0		SM	As above.	

49.6

Hand cleared to 5 ft, Refusal at 49.6 ft. Well set at 49.5 ft. (2 ft of screen).