

EPA/530/SW-91/051
May 1991

TECHNICAL GUIDANCE DOCUMENT:
INSPECTION TECHNIQUES FOR THE FABRICATION
OF
GEOMEMBRANE FIELD SEAMS

Cooperative Agreement No. CR-815692

Project Officers

Robert E. Landreth
David A. Carson
Waste Minimization, Destruction & Disposal Research Division
Risk Reduction Engineering Laboratory
Cincinnati, Ohio 45268

Office of Solid Waste and Emergency Response
U.S. Environmental Protection Agency
Washington, D.C.

In cooperation with

RISK REDUCTION ENGINEERING LABORATORY
OFFICE OF RESEARCH AND DEVELOPMENT
U.S. ENVIRONMENTAL PROTECTION AGENCY
CINCINNATI, OHIO 45268

 Printed on Recycled Paper

DISCLAIMER

The preparation of this document has been funded wholly by the United States Environmental Protection Agency. It has been subjected to the Agency's peer and administrative review, and it has been approved for publication as an EPA document. Mention of trade names or commercial products does not constitute endorsement or recommendation for use.

FOREWORD

Today's rapidly developing and changing technologies and industrial products and practices frequently carry with them the increased generation of solid and hazardous wastes. The U.S. Environmental Protection Agency is charged by Congress with protecting the Nation's land, air, and water resources. Under a mandate of national environmental laws, the agency strives to formulate and implement actions leading to a compatible balance between human activities and the ability of natural systems to support and nurture life. These laws direct the EPA to perform research to define our environmental problems, measure the impacts, and search for solutions.

The Risk Reduction Engineering Laboratory is responsible for planning, implementing, and managing research, development, and demonstration programs to provide an authoritative, defensible engineering basis in support of the policies, programs, and regulations of the EPA with respect to drinking water, wastewater, pesticides, toxic substances, solid and hazardous wastes, and Superfund-related activities. This publication is one of the products of that research and provides a vital communication link between the research and the user community.

This document provides guidance for construction quality control and construction quality assurance inspectors and related personnel as to the proper techniques for fabricating field seams in geomembranes. It focuses on six technical areas used to fabricate field seams of all types of geomembranes. The presentation of this information details geomembrane material preparation, equipment preparation, seam method evaluation through test strips, seaming process, inspection activities after seaming, and instructions for seaming under unusual conditions. Rationale is provided for the various conditions and limitations that are suggested. A glossary of terms relevant to the field seaming of geomembranes is provided at the end of the document.

E. Timothy Oppelt, Director
Risk Reduction Engineering Laboratory

PREFACE

Subtitle C of the Resource Conservation and Recovery Act (RCRA) requires the U.S. Environmental Protection Agency (EPA) to establish a Federal hazardous waste management program. This program must ensure that hazardous wastes are handled safely from generation until final disposition. EPA issued a series of hazardous waste regulations under Subtitle C of RCRA that are published in Title 40 Code of Federal Regulations (40 CFR). The principal 40 CFR Part 264 and 265 regulations were issued on July 26, 1982 for treatment, storage, and disposal (TSD) facilities and establish performance standards for hazardous waste landfills, surface impoundments, land treatment units, and waste piles. The regulations have been amended several times since then.

In support of the regulations, EPA has been developing three types of documents to assist preparers and reviewers of RCRA permit applications for hazardous waste TSD facilities. These include RCRA Technical Guidance Documents, Permit Guidance Manuals, and Technical Resource Documents (TRDs).

RCRA Technical Guidance Documents, such as this one, present design and operating parameters or design evaluation techniques that generally comply with, or demonstrate compliance with, the Design and Operating Requirements and the Closure and Post-Closure Requirements of 40 CFR Part 264.

The Technical Resource Documents present summaries of state-of-the-art technologies and evaluation techniques determined by the Agency to constitute good engineering designs, practices, and procedures. They support the RCRA Technical Guidance Documents and Permit Guidance Manuals in certain areas (i.e., liners, leachate management, final covers, and water balance) by describing current technologies and methods for designing hazardous waste facilities, or for evaluating the performance of a facility design. Although emphasis is given to hazardous waste facilities, the information presented in these TRDs may be used for designing and operating nonhazardous waste TSD facilities as well. Whereas the RCRA Technical Guidance Documents and Permit Guidance Manuals are directly related to the regulations, the information in these TRDs covers a broader perspective and should not be used to interpret the requirements of the regulations.

This document is a Technical Guidance Document prepared by the Risk Reduction Engineering Laboratory of EPA's Office of Research and Development in cooperation with the Office of Solid Waste and Emergency Response. The document has undergone extensive technical review and has been revised accordingly. With the issuance of this document, all previous drafts are obsolete and should be discarded.

Comments are welcome at any time on the accuracy and usefulness of the information in this document. Comments will be evaluated, and suggestions will be incorporated, wherever feasible, before publication of any future revisions. Written comments should be addressed to EPA RCRA Docket (OS-305), 401 M Street S.W., Washington, DC 20460. The document for which comments are being provided should be identified by title and number.

ABSTRACT

This Technical Guidance Document is meant to augment the numerous construction quality control and construction quality assurance (CQC and CQA) guidelines that are presently available for geomembrane installation and inspection. It is focused on all current methods of producing geomembrane seams including HDPE and VLDPE, PVC, PVC-R, CSPE, CSPE-R, CPE, CPE-R, EIA and EIA-R. In general, the tone of most of the existing guidelines is to allow the installer almost complete freedom in making seams with the only conditions being that they pass;

- (a) destructive shear and peel tests to a stipulated strength, and
- (b) selected nondestructive tests.

By developing a report somewhere between the typical CQC/CQA Documents and an installer's training manual, i.e., a "Technical Guidance Document", it is hoped that this document will provide meaningful insight for an inspector as to what the installer is trying to accomplish. At the same time it might be also helpful to the installer in recognizing that others have an interest in their specific activity. After some introductory material, the manual presents six specific methods used for fabricating field seams of the types of geomembranes being most widely used for environmental control systems. They are the following:

- extrusion fillet seams
- extrusion flat seams
- hot wedge seams
- hot air seams
- chemical fusion seams
- adhesive seams

TABLE OF CONTENTS

	<u>PAGE</u>
DISCLAIMER.ii
FOREWORD.iii
PREFACEiv
ABSTRACT.vi
LIST OF FIGURESx
LIST OF TABLES.xv
ACKNOWLEDGEMENTS.xvi
SECTION 1. INTRODUCTION AND AUDIENCE	1
SECTION 2. CONSTRUCTION QUALITY ASSURANCE CONCEPTS	5
SECTION 3. TERMINOLOGY AND PREPARATORY ISSUES.	9
3.1 TERMINOLOGY.	9
3.2 PREPARATORY ISSUES11
3.3 UNITS.13
3.4 TEST STRIPS.14
SECTION 4. AN OVERVIEW OF FIELD SEAMING METHODS.19
SECTION 5. DETAILS OF EXTRUSION FILLET SEAMS23
5.1 GEOMEMBRANE PREPARATION.23
5.2 EQUIPMENT PREPARATION.26
5.3 TEST STRIPS.29
5.4 ACTUAL SEAMING PROCESS31
5.5 AFTER SEAMING.40
5.6 UNUSUAL CONDITIONS41
SECTION 6. DETAILS OF EXTRUSION FLAT SEAMS45
6.1 GEOMEMBRANE PREPARATION.45
6.2 EQUIPMENT PREPARATION.48
6.3 TEST STRIPS.49
6.4 ACTUAL SEAMING PROCESS54
6.5 AFTER SEAMING.57
6.6 UNUSUAL CONDITIONS58

TABLE OF CONTENTS (continued)

	<u>PAGE</u>
SECTION 7. DETAILS OF HOT WEDGE SEAMS.63
7.1 GEOMEMBRANE PREPARATION.63
7.2 EQUIPMENT PREPARATION.66
7.3 TEST STRIPS.71
7.4 ACTUAL SEAMING PROCESS73
7.5 AFTER SEAMING.78
7.6 UNUSUAL CONDITIONS80
SECTION 8. DETAILS OF HOT AIR SEAMS85
8.1 GEOMEMBRANE PREPARATION.85
8.2 EQUIPMENT PREPARATION.91
8.3 TEST STRIPS.95
8.4 ACTUAL SEAMING PROCESS FOR THE MANUAL, HAND-HELD TYPE OF HOT AIR SEAMING97
8.5 ACTUAL SEAMING PROCESS FOR THE AUTOMATED, MACHINE-DRIVEN TYPE OF HOT AIR SEAMING.	101
8.6 AFTER SEAMING.	103
8.7 UNUSUAL CONDITIONS	105
SECTION 9. DETAILS OF CHEMICAL AND BODIED CHEMICALLY FUSED SEAMS	109
9.1 GEOMEMBRANE PREPARATION.	109
9.2 EQUIPMENT PREPARATION.	114
9.3 TEST STRIPS.	116
9.4 ACTUAL SEAMING PROCESS	121
9.5 AFTER SEAMING	126
9.6 UNUSUAL CONDITIONS	128
SECTION 10. DETAILS OF CHEMICAL ADHESIVE SEAMS	132
10.1 GEOMEMBRANE PREPARATION	132
10.2 EQUIPMENT PREPARATION	137
10.3 TEST STRIPS	139
10.4 ACTUAL SEAMING PROCESS.	144
10.5 AFTER SEAMING	149
10.6 UNUSUAL CONDITIONS.	152

TABLE OF CONTENTS (concluded)

	<u>PAGE</u>
SECTION 11. EMERGING TECHNOLOGIES FOR GEOMEMBRANE SEAMING.	156
11.1 ULTRASONIC SEAMS.	156
11.2 ELECTRICAL CONDUCTION SEAMS	158
11.3 MAGNETIC INDUCTION SEAMS.	158
SECTION 12. REFERENCES	162
SECTION 13. GLOSSARY OF TERMS.	166

LIST OF FIGURES

<u>FIG. NO.</u>	<u>PAGE</u>
3.1	Test strip process flow chart 16
5.1	Type of hook blade used for the cutting of liner materials. 24
5.2	Hand-held electric rotary grinder with circular disc grit grinding paper 27
5.3	Photographs of various types of extrusion fillet welding devices 28
5.4	Test strip process flow chart 30
5.5	Fabrication of geomembrane seam test strip. 32
5.6	Preparing the bevel of the upper geomembrane for liner thicknesses greater than 1.5 mil 34
5.7	Proper orientation and grinding preparation of sheets prior to tacking and extrudate placement 35
5.8	Photographs of different orientations of grinding patterns. 36
5.9	Photographs of different extent of grinding patterns after extrusion fillet seaming 38
5.10	Smooth propping wedge used when tacking of sheets is done before surface grinding of geomembrane sheets 39
5.11	Schematic diagrams of various cross sections of extrusion seams 39
5.12	Photographs of cross sections of various types of HDPE extrusion fillet seams 42
6.1	Type of hook blade used in the cutting of liner materials 47
6.2	Grinding locations and method used in the preparation of extrusion flat seams 49
6.3	Test strip process flow chart 51

LIST OF FIGURES (continued)

<u>FIG. NO.</u>	<u>PAGE</u>
6.4	52
6.5	56
6.6	57
6.7	59
7.1	65
7.2	68
7.3	69
7.4	72
7.5	74
7.6	76
7.7	79
7.8	80
7.9	81
8.1	87
8.2	87
8.3	88
8.4	92
8.5	94
8.6	96

LIST OF FIGURES (continued)

<u>FIG. NO.</u>	<u>PAGE</u>
8.7	98
8.8	100
8.9	102
8.10	104
8.11	105
8.12	106
9.1	111
9.2	112
9.3	115
9.4	116
9.5	118
9.6	119
9.7	122
9.8	123
9.9	123
9.10	125

LIST OF FIGURES (continued)

<u>FIG. NO.</u>	<u>PAGE</u>
9.11	Initial rolling motion parallel to seam for the fabrication of chemically fused seams of PVC liners125
9.12	Photographs of air lance and pick testing of completed seam127
9.13	Cross sections of PVC liner seams fabricated by the chemical fusion seaming method showing left, center, and right sides of completed seam129
10.1	Trimming of excess geomembrane to obtain proper overlap prior to seaming and types of scissors recommended for cutting of geomembranes.134
10.2	Photographs of a "fishmouth" and its correction and patching . . .135
10.3	Photograph of types of rollers used to apply pressure to bodied fusion chemical seams138
10.4	Test strip process flowchart.141
10.5	Photographs of preparation of a field test strip prior to production seaming142
10.6	Positioning of wooden seaming board beneath seam area145
10.7	Perspective diagram of locations where "T" configurations commonly occur147
10.8	Photograph of "T" trimming tool shaving the upper surface of an existing seam in preparation of new intersecting seam147
10.9	Initial rolling motion parallel to seam for the fabrication of adhesive seams for CEP, CSPE or PVC liners148
10.10	Photographs of air lance and pick testing of completed seam150
10.11	Cross section of CSPE-R liner seams fabricated by the chemical adhesive seaming method.151
11.1	Schematic diagrams of ultrasonic welding of plastic (and metal) sheets157

LIST OF FIGURES (concluded)

<u>FIG. NO.</u>		<u>PAGE</u>
11.2	Schematic diagram of rollers, ultrasonic horn and geomembrane sheets in the ultrasonic seaming process	157
11.3	Schematic diagram of an electrofusion pipe coupling process	159
11.4	Schematic diagram of the electrical conduction method of joining geomembrane	159
11.5	Schematic diagram of the magnetic induction method of joining geomembranes.	160

LIST OF TABLES

<u>TABLE NUMBER</u>		<u>PAGE</u>
3.1	Polyethylene Types	10
3.2	Compounded Thermoplastics and Thermoplastic Elastomers	10
4.1	Fundamental Methods of Joining Polymeric Geomembranes	18
4.2	Most Commonly Used Field Seaming Methods for Various Geomembranes	20
7.1	Temperature Ranges for Hot Wedge Seaming of Thermoplastic Geomembranes	70
8.1	Typical Temperature Ranges for Hot Air Seaming of Geomembranes	93



ACKNOWLEDGEMENTS

This technical guidance document grew out of a series of meetings of various manufacturers of geomembranes. Drafts were reviewed by the manufacturers, fabricators and installers of geomembranes, private consultants and owners of waste management facilities. Robert M. Koerner, Director of the Geosynthetic Research Institute, was the project coordinator who extends sincere appreciation for the cooperation of this group of organizations in sharing information and critiquing the various drafts of the document.

The EPA project manager of this technical guidance document was Robert E. Landreth with the assistance of David A. Carson. The authors wish to thank Donna A. Zunt, the preparer of the manuscript.

SECTION 1

INTRODUCTION AND AUDIENCE

The lining and capping of hazardous and nonhazardous solid waste landfills, surface impoundments and waste piles is a critical component in the prevention of contamination of subsurface soil and groundwater. When a solid or liquid contaminant is being contained, every aspect of the lining and capping system must undergo the closest possible scrutiny. The need for both construction quality control (CQC) and construction quality assurance (CQA) becomes requisite at many facilities. With an extremely large number of waste management construction and closure projects currently being planned and/or already under construction there also comes many organizations with a lack of experience in specialized topics. Certainly an area such as geomembranes made from thermoplastic polymers falls into this category. Many inspection firms entering into this area have had little formal training or practical experience in dealing with geomembranes. This is not to say that experienced firms are not available; they are indeed, and are very active in providing excellent inspection services. However, there appears to be a need to have a primer on certain aspects of geomembrane seaming which this document will fulfill.

This manual is very narrowly focused, addressing only one part of the total liner or final cover systems, that being field seaming methods for geomembranes. This manual assumes that the design has been completed and the material has been selected based on site specific functions and conditions. In this report all types of currently used geomembrane materials will be considered. They will be viewed with their customary method of seaming, and not from a materials classification. For example, for the hot wedge seaming method, focus will be on the idiosyncrasies of the method not the fact that most geomembranes can be seamed by this method. When information is required to distinguish between details such as seaming temperature from one geomembrane to another, it will be elaborated upon accordingly. Still further, it is the making (or fabrication) of the seams which will be the focus, not their destructive or nondestructive testing. There are numerous excellent documents on this latter topic, see, for example, Frobel (1), Lord, et al. (2), Overmann (3) Richardson (4), Haxo and Kamp (5), Peggs (6), etc.

This Technical Guidance Document is primarily intended for engineering organizations performing third-party inspection of geomembrane field seams. This activity falls under the category of Construction Quality Assurance (CQA). It is generally performed by engineering design firms, engineering testing organizations and (occasionally) by manufacturer/installers who are separated from the Construction Quality Control (CQC) activities. The document has obvious overlaps with both public and private owner/operator



concerns and can be used to amplify and extend their standard CQC/CQA Documents on an as-required basis.

When using the document for the first time, the reader should become familiar with the introductory material included in Sections 1 to 4. In these sections various clarifications of terminology, definitions, departures from current practice and other matters are described. Following this introductory material, however, the user should proceed directly to the section on field seaming that is of direct interest. Each of these sections, i.e., Section Nos. 5 to 10, are written in a "stand-alone" fashion. Thus repetition within these different sections was necessary to avoid "flip-flopping" between sections. Of course, if one cares to read the manual in its entirety, it becomes a tutorial on all of the currently available geomembrane seaming methods. Section 11 pertains to seaming technologies currently under development.

This Technical Guidance Document provides a field CQA person with a readily accessible set of details of the essential aspects of the field seaming procedure under concern. It also provides, in as much as possible, the explanation for stating these details. By following its guidance it is hoped that the manual's user will be better aware of what the installer is trying to achieve and the rationale for performing any specific activity. The document does not purport to be an installers procedural manual on how to physically make geomembrane field seams. There are numerous CQC manuals available by manufacturer/installer organizations as well as owner/operator organizations for that purpose.

FIELD NOTES:



FIELD NOTES:

SECTION 2

CONSTRUCTION QUALITY ASSURANCE CONCEPTS

As written in EPA Report 600/2-88/052 entitled "Lining of Waste Containment and other Impoundment Facilities" (7) construction quality assurance (CQA) is a planned system of activities that provides assurance that the unit is constructed as specified in the design. Thus, CQA refers to those activities initiated by the owner of the facility to ensure that the construction of the entire facility, including manufacture, fabrication, and installation of the various components of the lining and final cover systems, meets design specifications and performance requirements. The activities include inspections, verifications, audits, and evaluations of materials and workmanship necessary to determine and document the quality of the constructed facility. These activities are often performed by an owner/operator contracted third-party quality assurance team that is independent of the designer, manufacturer, fabricator, and installer to ensure impartiality.

It should be noted that Construction Quality Control (CQC) and Construction Quality Assurance (CQA) are often loosely used terms covering the entire range of construction activities. They are, however, used quite rigorously in this Technical Guidance Document.

- Construction Quality Control (CQC), or simply Quality Control, refers to activities conducted by the manufacturer and/or installer to bring to bear the highest quality construction activities for the situation under concern. In this manual, it is the fabrication of geomembrane field seams. There often will be a separate document to define and elaborate on the various details. This document is usually developed "in-house", in that it is voluntarily offered to show the degree of seriousness to which the manufacturer/installer intends to go about the construction of the geomembrane field seams. It will be referred to as the "CQC Document."
- Construction Quality Assurance (CQA), or simply Quality Assurance, is completely separate from CQC. It cannot be done by the same individuals or even the same organizations. It is often referred to as "third party" inspection suggesting that an organization, or persons, not affiliated with the owner/operator or manufacturer/installer is performing the inspection activities. This is the intended audience for this Technical Guidance Document. The formation of such a CQA activity, and the role it has in the inspection of geomembrane field seams, is defined in a document which will be referred to in this manual as the "CQA Document." CQC and CQA will obviously overlap in many instances. The ultimate



case geomembrane field seams. The separate documents, referred to herein collectively as "CQC/CQA Documents," should be synchronized with one another. Any differences between the two documents, or between these two documents and the contract plans and specifications must be addressed at a Pre-Construction meeting. All parties involved must be aware that this Pre-Construction meeting is where the "ground rules" for construction will occur and all parties will thereafter perform and act accordingly.

Regarding the elements of a CQC/CQA Document, EPA Report 530-SW-86-031 (NTIS PB87-132825) entitled "Construction Quality Assurance for Hazardous Waste and Land Disposal Facilities" (8) presents the following key elements:

- Responsibility and Authority - The responsibility and authority of organizations and personnel involved in permitting, designing, and constructing the facility should be described in the CQC/CQA Documents.
- CQA Personnel Qualifications - The qualifications of the CQA officer and supporting CQA inspection personnel should be presented in the CQC/CQA Documents.
- Inspection Activities - The observations and tests that will be used to ensure that the construction or installation meets or exceeds all design criteria, plans, and specifications for each component should be described in the CQC/CQA Documents.
- Sampling Strategies - The sampling activities, sample size, methods for determining sample locations, frequency of sampling, acceptance and rejection criteria, and methods for ensuring that corrective measures are implemented should be presented in the CQC/CQA Documents.
- Documentation - Reporting requirements for CQA activities should be described in detail in the CQC/CQA Documents.

This particular guidance document focuses on one specific aspect of CQA namely the inspection of the fabrication of field seams used in the joining of the most commonly used geomembranes.

FIELD NOTES:

FIELD NOTES:



SECTION 3

TERMINOLOGY AND PREPARATORY ISSUES

The design of a geomembrane for a lined facility involves a substantial amount of work before the actual construction is performed. In order that the reader understands and appreciates the importance of some of these preactivities, it was felt that a section on historical and future perspectives, including assumptions, was needed. The authors have also attempted to standardize or clarify terminology to more accurately reflect current industry practice.

3.1 TERMINOLOGY

Many polymers commonly used in the manufacture of geomembranes, previously called flexible membrane liners (FML), have been inaccurately named, titled and described. Polymeric resins and processing methods evolve over time to provide products that will serve their intended design function better over long periods of time. As more products become available, it is important to understand the proper descriptions for various polymeric geomembrane materials.

In current practice, the term "high density polyethylene (HDPE)" is used to describe geomembranes whose base resin may actually be medium density polyethylene (MDPE). There are several resins of different densities currently used in the manufacture of polyethylene geomembranes, see Table 3.1.

The density ranges on Table 3.1 are for the basic polymer, i.e. the resin, before addition of carbon black and other additives to either increase performance and durability or assist in production. This document will utilize the ASTM designation HDPE to reflect the material in use today. Very low density polyethylene (VLDPE) resin falls into the density range below 0.910 g/cc and is not yet designated by ASTM.

Some geomembrane sheets are compounded versions of relatively rigid thermoplastic polymers, such as polyvinyl chloride (PVC). Other geomembranes are compounded versions of elastomers, such as chlorosulfonated polyethylene (CSPE). Each is formulated with specific expectations in mind ranging from long-term flexibility, to long-term weatherability, to cost. The authors will utilize the terminology "compounded thermoplastic" or "thermoplastic elastomers" to reflect the actual material in use today. Table 3.2 lists several of these liner materials that are in current use.

TABLE 3.1. POLYETHYLENE TYPES.*

Acronym	Type	Nominal Density Range	ASTM D 1248 Type
HDPE	High Density Polyethylene	≥ 0.960 g/cc	IV
HDPE	High Density Polyethylene	0.941 to 0.959 g/cc	III
MDPE	Medium Density Polyethylene	0.926 to 0.940 g/cc	II
LDPE	Low Density Polyethylene	0.910 to 0.925 g/cc	I
----	Not designated	< 0.910 g/cc	0

* Uncolored, unfilled material

TABLE 3.2. COMPOUNDED THERMOPLASTICS AND THERMOPLASTIC ELASTOMERS.*

PVC	EIA
PVC-R**	EIA-R
CPE	CSPE
CPE-R	CSPE-R

* See Section 13, Glossary of Terms for definitions.

** "R" denotes fabric reinforced geomembrane.

Resins used in pipes, fittings and appurtenances are generally significantly different from those used in the manufacture of geomembranes. While prefabricated boots may make installation more convenient, it may not be possible to seam geomembranes directly to these other items. Further, the junction is generally fortified with a mechanical connection to ensure a flexible watertight bond. These details must be clearly stipulated in the CQA/CQC Documents.

One of the fundamental methods of joining polymer geomembrane sheets is with a chemical processes of chemical fusion or chemical-adhesive methods. Commonly referred to as "solvent welding," or "solvent seaming," a more generic term "chemical bonding" will be used in this document. The methods

and materials used to perform this type of bonding can vary widely, and may vary in accordance with site conditions. The designer should evaluate these variances and incorporate them into the CQC/CQA Documents.

Workers and inspectors should protect themselves from long-term exposure to the chemicals present during any installation. The safety precautions printed on the labels of all chemicals should be followed. Personal protective equipment should exceed the minimal requirements listed on the labels. Material Safety Data Sheets should also be reviewed prior to exposure. State and local safety regulations should be followed.

Workers and inspectors should also be aware that some seaming devices can and do get very hot. These devices require the use of extension cords which could cause personnel to trip and fall. Hot air/gas seaming devices or other air blowing devices may cause dirt to be blown into eyes. All appropriate state and local safety regulations should be followed.

Following conventional usage, the term "hot air" has been used when speaking of the process involving hot gas to seam geomembrane sheets. Certain unusual circumstances may require the use of an alternate heat conveyance gas other than air. The use of such an alternative must be clearly stated in the CQC/CQA Documents.

3.2 PREPARATORY ISSUES

This document is intended to provide guidance for the inspection of geomembrane seams being fabricated in the field. To this end, several assumptions have been made regarding the actual material brought or delivered to the installation site. This document assumes that the facility design has been completed, the material has been selected based on specific site functions and conditions and that CQC/CQA Documents have been developed.

Inherent in these broad assumptions are the following items:

- (1) The designer should prequalify the material and seaming technique, before the actual installation, and include in the CQC/CQA Documents evaluation procedures to verify the quality of the actual seams. In these cases such concerns as stress cracking and/or chemical resistance of the geomembrane sheet and seams, or percentage of full seam strength could be resolved. The prequalifying period may also be used to correlate accelerated (e.g. oven) aging of chemical seams with full seam strength without acceleration. However, these prequalification tests are to be used only for general acceptance as the actual field seam should be accepted/rejected based on actual field samples based on the CQC/CQA Documents.
- (2) The soil subgrade has been prepared such that no rocks, sticks, sudden elevation changes, etc., are present to damage the geomembrane sheet by puncturing from below or from damage

resulting from installation personnel walking or equipment (e.g., rubber tired generators) being on top of the geomembrane.

- (3) The design considered the appropriate thickness of the material being installed. This includes but is not limited to: minimum regulatory material requirements; thickness variation due to manufacturing; thickness changes due to material preparation (grinding or softening geomembrane surface layers) and design requirements. It is recognized that the seam areas can be the weak points in the geomembrane system. The design should consider the above factors independently and jointly as they may result in stress concentrations.
- (4) The facility design includes consideration for durability of the material. Service life of the geomembrane may be affected by seam cracking or mechanical fatigue that may cause cracking or catastrophic failure; swelling and softening of polymeric components due to absorbed waste constituents combined with an overburden load that may cause creep-induced damage; and extraction, volatilization, or biodegradation of additives in the compounds due to long-term exposure that may cause degradation of polymeric materials.
- (5) The design has taken site specific conditions such as potential temperature and humidity into consideration when selecting the geomembrane material to be installed and the actual seaming technique to be used at that specific site. When seaming geomembrane sheet it is actually the sheet temperature that influences the quality of the seam. It is, therefore, recommended that geomembrane sheet temperature be measured rather than ambient temperature.
- (6) It is also recognized that moisture can cause a detrimental effect on seam quality. In those cases where chemicals are used to make the seam the designer should understand that the process of evaporation of the chemical involves the consumption of heat (heat of vaporization) from the geomembrane being seamed and thus can cool the geomembrane surface resulting in moisture condensation in the seam area when the relative humidity is high. The point is that temperature and humidity at the time of installation may affect the selection of the chemical mixture used. This same heat phenomenon will also cause condensation in seam areas for hot wedge and extrusion welds.
- (7) Grinding of sheet edges in preparation for extrusion welding should always be done to leave marks perpendicular to the sheet edge, to the extent possible. Insufficient data exists to definitively determine whether all grind marks should be covered. It is generally recognized that they should, but it is also known that extrudate over unground area will not form a good bond. The designer should specify or recommend which procedure will be acceptable and how to evaluate this through the CQC/CQA Documents.

- (8) The number and spacing of destructive tests in production seams has been clarified and stipulated in the CQC/CQA Documents. This includes the length of the destructive test sample, how sections are distributed, when and to whom test results are due, and acceptance/rejection criteria.
- (9) The CQC/CQA Documents should be very specific when new to old sheets are being seamed in the field, when different thicknesses of the same sheet are being seamed together, when different materials are seamed together (e.g. PVC and CSPE, VLDPE and HDPE, etc.), when sheet is bonded or joined to pipes, manholes, and/or other appurtenances, or for other unusual conditions.
- (10) The design and CQC/CQA Documents have determined the number, length, distribution and testing of seam test strips. One could envision individual samples for the owner/operator for site approval, the geomembrane manufacturer, for archive purposes and for the regulatory community. All of these requirements may result in test strip lengths from 1.5 to 4.5 m (5 to 15 ft.) or more. The length should be determined based on which ASTM test will be used for seam evaluation as well as the number of interested parties; in any case the total length should be specified in the CQC/CQA Documents. The implications of failure of these test strips must be clearly understood by all parties.

3.3 UNITS

In past EPA documents, all dimensions in the text, tables and figures have been traditional, or English units, i.e., the "foot-pound-degree Fahrenheit" system of measurement. The future, as we all know, is toward the use of metric units, i.e., the "meter-gram-degree Centigrade" system. This latter system has been slightly revised into the ("Système Internationale d'Unités") units or simply "S.I." units and is rapidly being accepted on a worldwide basis.

This manual is written in dual units with the S.I. units as the preferred units and the standard units following in parenthesis. It is more than likely that future EPA documents will be in S.I. units only, thus a complete familiarization will eventually be necessary.

A word of explanation as to unit of length is necessary. The S.I. unit of length is the millimeter (mm). Recognize that it is a very small value, i.e., 1 mm = 0.04 inches. Thus the coverage of a 6 inch patch over a hole in a geomembrane would convert to 150 mm. Note that the tolerance of this value should be considered equivalently, i.e. we are not inferring a tolerance of 1 mm, but the usual tolerance of say 1 inch which would be approximately 25 mm. Thus to ease the unfamiliar reader into S.I. units we have written the text in centimeters so as to take the customary values of tolerance into account. The figures, however, have been labeled in

millimeter and meter units which are the recommended S.I. values to use and rounded for convenience.

With regular use of S.I. units and thinking in this manner, the differences between mm, cm, and m values will become routine.

3.4 TEST STRIPS

Test (or trial) strips, also called qualifying seams, are considered to be an important aspect of CQC/CQA procedures. They are meant to serve as a prequalifying vehicle for personnel, equipment and procedures for making seams under identical material and climatic conditions as will be the actual production field seams. The test strips are usually made on two narrow pieces of excess geomembrane varying in length between 1.5 to 4.5 m (5 to 15 ft.). The test strips should be made in sufficient lengths, preferable as a single continuous seam, for all required purposes.

The goal of these activities is to imitate all aspects of the actual production field seaming activities intended to be performed in the immediately upcoming work session to estimate seam quality. Ideally, test strips can estimate the quality of the production seams while minimizing damage to the installed geomembrane through destructive mechanical testing. They are typically made every 4 hours (for example, at the beginning of the work shift, after the lunch break) or whenever personnel or equipment changes and when climatic conditions reflect wide changes in geomembrane temperature ($\pm 5^{\circ}\text{C}$ [$\pm 9^{\circ}\text{F}$] change in one hour) or other conditions that could affect seam quality. These details, including the minimum level of destructive testing of the production field seams should be stipulated in the Contract Specifications or CQC/CQA Documents.

The destructive testing of the test strips in shear and peel should be done as soon as the installation contractor feels that the strength requirements of the Contract Specification or CQA/CQA Documents can be met. This is generally done at the site using a field tensiometer. Thus it behooves the contractor to have all aspects of the test strip seam fabrication in complete working order just as would be done in the case of fabricating production field seams.

In the flow chart following it is seen that failed test strips are linked to an increased frequency of destructive tests to be taken on production field seams made during the time interval between making the test strip and its testing. Furthermore, it is seen that there are only two chances at making adequate test strips before production field seaming is stopped and repairs are initiated. The specifics of these repairs are not defined in this document. They should be covered in either the Contract Specification or the CQC/CQA Documents.

Additional text for conducting these tests is located in each of the specific seam focused sections and generally follows the activity pattern described in Figure 3.1.

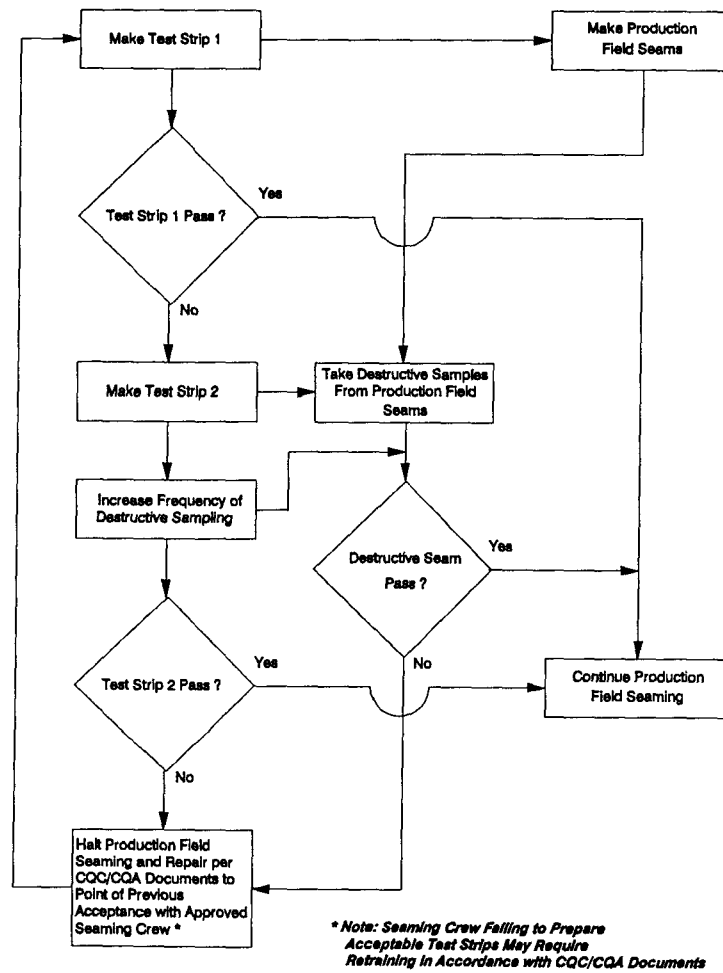

Figure 3.1 Test strip process flow chart.

FIELD NOTES:



SECTION 4

AN OVERVIEW OF FIELD SEAMING METHODS

The fundamental mechanism of joining polymer geomembrane sheets is to temporarily reorganize the polymer structure of the two surfaces in a controlled manner (i.e. melt or soften) that, after the application of pressure and after the passage of a certain amount of time, results in the two sheets being bonded together. This reorganization results from an input of energy that originates from either chemical or thermal processes. These processes may involve the addition of extra polymer in the bonded area.

Ideally, seaming two geomembrane sheets would result in no net loss of tensile strength across the two sheets and the joined sheets would perform as one single geomembrane sheet. However, due to stress concentrations resulting from the seam geometry, current seaming techniques may result in minor tensile strength loss compared to the parent geomembrane sheet. The characteristics of the seamed area are a function of the type of geomembrane and the seaming technique used. These factors, such as residual strength, geomembrane type, and seaming type, should be recognized by the designer when applying the appropriate design factors of safety for the overall geomembrane function and facility performance.

It should be noted that the seam can be the location of the lowest tensile strength in a geomembrane liner. Designers and inspectors should be aware of the importance of seeking only the highest quality geomembrane seams. The minimum seam tensile strengths (as determined by design) for various geomembranes must be predetermined by laboratory testing, knowledge of past field performance, manufacturers literature, various trade journals or other standard setting organizations that maintain current information on seaming techniques and technologies.

The methods of seaming at the time of the printing of this document and discussed herein are shown in Table 4.1.

Within the entire group of thermoplastic geomembranes that will be discussed in this manual, there are four general categories of seaming methods: extrusion welding, thermal fusion or melt bonding, chemical fusion and chemical adhesive seaming. Each will be explained along with their specific variations so as to give an overview of field seaming technology.

Extrusion welding is presently used exclusively on geomembranes made from polyethylene. A ribbon of molten polymer is extruded over the edge of, or in between, the two surfaces to be joined. The hot extrudate causes the surfaces of the sheets to become hot and melt, after which the entire mass then cools and bonds together. The technique is called extrusion fillet seaming when the

TABLE 4.1. FUNDAMENTAL METHODS OF JOINING POLYMERIC GEOMEMBRANES

Thermal Processes	Chemical Processes
Extrusion Fillet (Ch. 5)	Chemically Fused:
Extrusion Flat (Ch. 6)	• Chemical (Ch. 9)
Hot Wedge (Ch. 7)	• Bodied Chemical (Ch. 9)
Hot Air (Ch. 8)	Chemical Adhesive (Ch. 10)

extrudate is placed over the leading edge of the seam, and is called extrusion flat seaming when the extrudate is placed between the two sheets to be joined. It should be noted that extrusion fillet seaming is essentially the only method for seaming polyethylene geomembrane patches and in poorly accessible areas such as sump bottoms and around pipes. Temperature, pressure, and seaming rate all play important roles in obtaining an acceptable bond; too much melting weakens the geomembrane and too little melting results in inadequate flow across the seam interface and in poor seam strength. The polymer used for the extrudate is also very important and is usually the same polyethylene compound that was used to make the geomembrane. The designer should specify acceptable extrusion compounds and how to evaluate them in the CQC/CQA Documents.

There are two thermal fusion or melt-bonding methods that can be used on all thermoplastic geomembranes. In both of them, portions of the opposing surfaces are truly melted. This being the case, temperature, pressure, and seaming rate all play important roles in that too much melting weakens the geomembrane and too little melting results in poor seam strength. The hot wedge or hot shoe method consists of an electrically heated resistance element in the shape of a wedge that travels between the two sheets to be seamed. As it melts the surface of the sheets being seamed, a shear flow occurs across the upper and lower surfaces of the wedge. Roller pressure is applied as the two sheets converge at the tip of the wedge to form the final seam. Hot wedge units are automated as far as temperature, amount of pressure applied and travel rate. A standard hot wedge creates a single uniform width seam while a dual hot wedge (or "split" wedge) forms two parallel seams with a uniform unbonded space between them. This space can be used to evaluate seam quality and continuity of the seam by pressurizing the space with air and monitoring any drop in pressure that may signify a leak in the seam.

The hot air method makes use of a device consisting of a resistance heater, a blower, and temperature controls to blow hot air between two sheets to melt the opposing surfaces. Immediately following the melting of the surfaces, pressure is applied to the seamed area to bond the two sheets. As with the hot wedge method both single and dual seams can be produced. In selected situations, this technique will be used to temporarily "tack" weld two sheets together until the final seam or weld is accepted.

Regarding the chemical fusion seam types; chemical fusion seams make use of a liquid chemical applied between the two geomembrane sheets to be joined. After a few seconds to soften the surface, pressure is applied to make complete contact and bond the sheets together. As with any of the chemical seaming processes to be described, a portion of the two adjacent materials to be bonded is truly transformed into a viscous phase. Too much chemical will weaken the adjoining sheet, and too little chemical will result in a weak seam. Bodied chemical fusion seams are similar to chemical fusion seams except that 1-10% of the parent lining resin or compound is dissolved in the chemical and then is used to make the seam. The purpose of adding the resin or compound is to increase the viscosity for slope work and/or adjust the evaporation rate of the chemical. This viscous liquid is applied between the two opposing surfaces to be bonded. After a few seconds, pressure is applied to make complete contact. Chemical adhesive seams make use of a dissolved bonding agent (an adherent) which is left after the seam has been completed and cured. The adherent thus becomes an additional element in the system. Contact adhesives are applied to both mating surfaces. After reaching the proper degree of tackiness, the two sheets are placed on top of one another, followed by roller pressure. The adhesive forms the bond and is an additional element in the system.

Other emerging seaming methods use ultrasonic, electrical conduction and magnetic induction energy sources. Since these methods are in a development stage, they are included in a separate section entitled, "Emerging Technologies for Geomembrane Seaming."

In order to gain an overview as to which seaming methods are used for the various thermoplastic geomembranes described in this document, Table 4.2 is offered. It is generalized, but it is used to further introduce the six specific seaming methods to be described in the following sections.

TABLE 4.2. MOST COMMONLY USED FIELD SEAMING METHODS FOR VARIOUS GEOMEMBRANES.

Type of Seaming Method	Type of Geomembrane									
	CPE	CPE-R	CSPE-R	EIA	EIA-R	HDPE	PVC	PVC-R	VLDPE	
extrusion fillet	n/a	n/a	n/a	n/a	n/a	A	n/a	n/a	A	
extrusion flat	n/a	n/a	n/a	n/a	n/a	A	n/a	n/a	A	
hot air	A	A	A	A	A	A	A	A	A	
hot wedge	A	A	A	A	A	A	A	A	A	
chemical	A	A	A	A	A	n/a	A	A	n/a	
adhesive	A	A	A	A	A	n/a	A	A	n/a	

Note: A = method is applicable
n/a = method is "not applicable"

FIELD NOTES:

FIELD NOTES:



SECTION 5

DETAILS OF EXTRUSION FILLET SEAMS

As seen in Table 4.2, extrusion fillet seaming is an applicable seaming method for HDPE and VLDPE geomembranes. In fact, around details such as pipes and sumps it is always necessary to use a certain amount of extrusion fillet seaming. This method is also used for repairs. Thus the text in this section is written with HDPE and VLDPE geomembranes in mind.

5.1 GEOMEMBRANE PREPARATION

- (a) Note, that this document assumes that the proper geomembrane has been visually inspected to ensure that the sheet is free of deep scratches or defects that would cause the sheet to not meet the specifications of the installation. It is further assumed the sheet has been delivered to the site and brought to its approximate plan position for final installation and seaming. Only the material that can be seamed that day should be deployed. All deployed material should be adequately ballasted to prevent wind uplift.
- (b) The geomembrane, HDPE or VLDPE, will usually arrive on site in rolls.
- (c) The geomembrane should remain packaged or rolled and dry until ready to use. The material should not be unrolled if the material temperatures are lower than -10°C (14°F) due to the possibility of cracking. If the panel is stored in a warm place, e.g. 10°C (50°F) or above, prior to being unrolled on site, then it can be placed at -18°C (0°F) or below temperatures providing the time between removing the geomembrane from storage and deployment does not exceed one-half working day. Geomembrane deployment may be allowed under other conditions but the CQC/CQA Documents and/or project specifications must be specific as to the conditions.
- (d) The two geomembrane sheets to be joined must be properly positioned such that approximately 7.5 cm to 15.0 cm (3 to 6 inches) of overlap exists.
- (e) All personnel walking on the geomembrane should have smooth soled shoes. Heavy equipment, e.g. pickups, tractors, etc., should not be allowed on the geomembrane at any time, unless otherwise specified by the manufacturer and approved in the CQC/CQA Documents.

- (f) If the overlap is insufficient, lift the geomembrane sheet up to allow air beneath it and "float" it into proper position. Avoid dragging geomembrane sheets made from HDPE particularly when they are on rough soil subgrades since scratches in the material may create stress points of different depths and orientations.
- (g) If the overlap is excessive and is to be removed, it should be done by trimming the lower sheet only. If this is not possible and the upper sheet must be trimmed, do not use a knife with an unshielded blade to cut off the excessive amount because the blade facing downward can easily scratch the underlying geomembrane in a very vulnerable location. A shielded blade or a hook blade should be used to trim off the excess geomembrane. A photograph of such a device is shown in Figure 5.1. Whenever possible it should be used from beneath the liner in an upward cutting motion.



Figure 5.1. Type of hook blade used for the cutting of liner materials.

- (h) All cutting and preparation of odd shaped sections or small fitted pieces should be completed at least 15 m (50 ft.) ahead of the seaming operation so that seaming may be continued with as few interruptions as possible.
- (i) Visually check the two opposing geomembrane sheets to be joined for defects of sufficient magnitude to affect seam quality. The criteria to be met and the procedures to be used in this regard should be stipulated in the contract specifications and/or in the CQC/CQA Documents.

- (j) If the Construction Plans require overlaps to be shingled in a particular direction, this should be checked.
- (k) Excessive undulations (waves) along the seams during the seaming operations should be avoided. When this occurs due to either the upper or lower sheet having more slack than the other or because of thermal expansion or contraction, it often leads to the undesirable formation of "fishmouths" which must be trimmed, laid flat and reseamed with a patch.
- (l) There should be some slack in the installed liner, which depends on the type of geomembrane, the ambient and anticipated service temperatures, length of time the geomembrane will be exposed, location in the facility, etc. This is a design consideration and the Contract Plans and Specifications must be project specific on the amount and orientation of slack.
- (m) The sheets which are overlapped for seaming must be clean. If dirty, they must be wiped clean with dry rags or other appropriate materials.
- (n) The sheets which are overlapped for seaming must be completely free of moisture in the area of the seam. In the case of moisture, air blowers are usually preferred over rags for drying the geomembrane.
- (o) Seaming is not allowed during rain or snow, unless proper precautions are made to allow the seam to be made on dry geomembrane materials, e.g., within an enclosure or shelter.
- (p) It is preferable not to have water-saturated soil beneath the geomembrane during installation. Seaming boards help in this regard by lifting the seams off the soil subgrade.
- (q) If the soil beneath the geomembrane is frozen, the heat of seaming can thaw the frost possibly allowing water to condense on the unbonded region ahead of the seam being fabricated. This possibility may be eliminated by the use of suitable seaming boards or slip sheets made from excess pieces of geomembrane.
- (r) The temperature of the geomembrane for seaming should be above freezing, i.e. 0°C, (32°F) unless it can be proven with test strips that good seams can be fabricated at lower temperatures. However, temperature is less a concern to good seam quality than is moisture.
- (s) For cold weather seaming, it may be advisable to preheat the sheets with a hot air blower, to use a tent of some sort to prevent heat losses during seaming and to make numerous test strips in order to determine appropriate seaming conditions, e.g., equipment temperatures may have to be set higher and seaming rates slowed down during cold weather seaming.

- (t) Sheet temperatures for seaming should be below 50°C (122°F) as measured by an infrared thermometer or surface contact thermocouple. It is recognized that depending on material type and thickness, higher temperatures may be allowed. It should also be recognized that wind and cloud cover will determine the actual sheet temperature. High temperatures affect not only worker performance but will also effect durability of some geomembranes unless special precautions, e.g. tents, etc., are taken. For temperatures above this value special attention should be paid to the seaming operation. Frequent test strips and more diligent nondestructive testing is recommended.
- NOTE:** For items (q), (r), (s,) and (t) the CQC/CQA Documents and/or project specifications and the regulatory requirements regarding hot and cold temperature seaming limitations should be reviewed to avoid possible problems with final construction certification acceptance.

5.2 EQUIPMENT PREPARATION

- (a) Properly functioning portable electric generators must be available within close proximity of the seaming region and with adequate extension cords to complete the entire seam. These generators should be of sufficient size or numbers to handle all seaming electrical requirements. The generator must have rubber tires, or be placed on a smooth plate such that it is completely stable so that no damage can occur to the geomembrane or to the underlying clay liner or subgrade material. Fuel (gasoline or diesel) for the generator must be stored away from the geomembrane and if accidentally spilled on the geomembrane it must be immediately removed. The area should be inspected for damage to the geomembrane and repaired if necessary.
- (b) An electric rotary grinder having a grinding disk of approximately 10 cm (4 inch) in diameter and a sufficient quantity of #80 grit paper must be available, see the photograph in Figure 5.2. Also acceptable is #100 grit paper which is finer than #80. Sandpaper coarser than #80, e.g. #60, is not acceptable. Caution should be used to prevent overgrinding.
- (c) A hot air welder with temperature capability to 250°C (475°F) must be available to periodically tack weld the geomembrane sheets after they are properly positioned. The hot air tacking should not be strong enough to produce a film tearing bond or interfere with the testing of the seam in either peel or shear. Occasionally, double-sided tape is used to temporarily anchor two sheets to be seamed. This practice is not recommended unless the tape is placed sufficiently far from the seam itself to ensure that it will not get to the seam area.

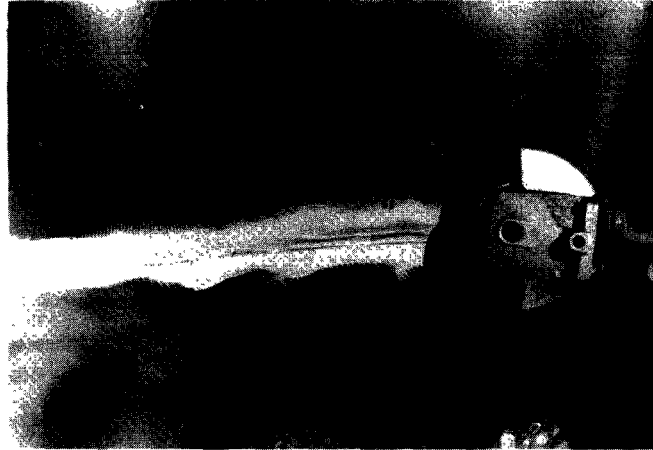

Figure 5.2. Hand-held electric rotary grinder with circular disc grit grinding paper.

- (d) The extrusion fillet welding apparatus may be of two types, depending upon the location where the seams are to be made. Either rubber wheeled, automated seam extruders or hand-held portable extruders are available. Photographs of various systems are shown in Figure 5.3.
- (e) All extrusion fillet seaming devices must be equipped with properly functioning temperature controllers displaying the temperature in the extrusion barrel so that it may be monitored by seaming personnel. It is recommended that the temperature of the extrudate be periodically made to check the reading of the thermocouple permanently mounted on the barrel. The CQC/CQA Documents should be reviewed for appropriate temperature ranges.
- (f) Extrusion fillet seaming devices have various Teflon or metal dies of different shapes and sizes where the extrudate exits onto the geomembrane. These dies must be inspected for wear, sharp notches or creases, and for correctness for the particular application. Commercially available extrusion dies are available for most common geomembrane thicknesses. Many, however, are specifically made or modified by installers. Both the width and thickness of the extrudate are dependent upon the proper die. It should be noted that nozzle selection will vary with geomembrane thickness.



Figure 5.3. Photographs of various types of extrusion fillet welding devices.
Upper: Automated type
Lower: Hand-held type

- (g) Adequate extrudate welding rods or pellets, of the same composition as the geomembrane itself, must be used. They must be dry, clean and ready for feeding through the extruder. All extrudate resin must be properly formulated so as to be the same compound as the geomembrane sheet material. Manufacturers may be required to provide a certification letter indicating that the welding rod or pellets and the sheet are the same compound. If in doubt, verification methods must be performed, see Reference 7. All extrudate material must be kept dry and free of dirt, debris and foreign matter. When welding rod is used the size must be consistent and appropriate for the seaming device.

5.3 TEST STRIPS

A general requirement of most CQA Documents is that "test seams" or "test strips" be made on a periodic basis. Test strips generally reflect the quality of field seams but should never be used solely for final field seam acceptance. Final field seam acceptance should be specified in the contract specification and should include a minimum level of destructive testing of the production field seams. Test strips are made to minimize the amount of destructive sampling/testing which requires subsequent repair of the final field seam. Typically these test seams, for each seaming crew, are made about every four hours, or every time equipment is changed, or if significant changes in geomembrane temperature are observed, or as required in the contract specification. This is a recommended practice that should be followed when seaming all types of geomembranes. The purpose of these tests is to establish that proper seaming materials, temperatures, pressures, rates, and techniques along with the necessary geomembrane pre-seaming preparation is being accomplished. Test strips may be used for CQA/CQC evaluation, archiving, for exposure tests, etc., and must be of sufficient length to satisfy these various needs.

Each seaming crew and the materials they are using must be traceable and identifiable to their test seams. While the test seams are being prepared, cured, and CQC tested, the seaming crew may continue to work as long as the seams they have made (and are making) since their last acceptable test sample strip was prepared, are completely traceable and identifiable. If a test seam fails to meet the field seam design specification, then an additional test seam sample will have to be made by the same seaming crew - using the same tools, equipment and seaming materials - and retested.

The liner's finished field seams will not be accepted unless the before and after "test seam sample strip" CQC test results (or other CQC seam test result criteria as required per the design specification) are acceptable per the site's design specifications. If a seam is not accepted, destructive testing of samples from the actual seam will be removed from the liner and tested. If the actual seam destructive test results still do not meet the design specification requirement, then the unacceptable seams will all have to be repaired or reconstructed with seaming materials by a test proven seaming crew that has passed its testing requirements. The procedure illustrated in the flow chart of Figure 5.4 must be followed. Note that the

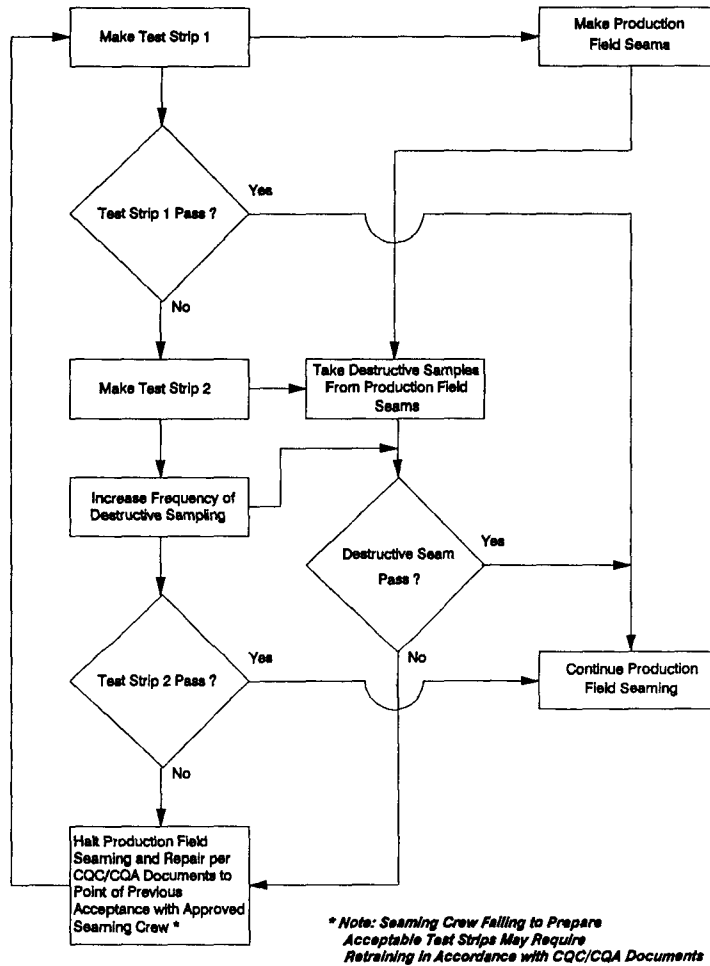

Figure 5.4. Test strip process flow chart.

failure of test strip 1 requires two actions: (a) the making of test strip 2, and (b) an increased frequency of destructive tests on production field seams made during the curing of test strip 1 (if any were made). This increased frequency must be stipulated in the contract specifications or in the CQC/CQA Documents.

If the destructive seams fail or if test strip 2 fails, production field seaming is halted. All production field seams made during the interval are repaired per the contract specifications or CQC/CQA Documents to the point of previous acceptance with an approved seaming crew.

At this point, the seaming crew that failed to pass both strip tests must adjust and recertify current seaming equipment and technique or obtain new seaming equipment, tools and/or retrain personnel and begin making initial test strip samples.

Test strips are shown in Figure 5.5(a-e). Figure 5.5(a) shows a sample of the geomembrane being cut to form the two pieces to be seamed together. Figure 5.5(b) shows the hot air tacking of the two pieces together so as to maintain their respective positions. Figure 5.5(c) shows the grinding and beveling of the leading edge for deposition of the extrudate. Figure 5.5(d) shows the extrusion fillet seam being placed symmetrically over the edge of the upper sheet. Figure 5.5(e) shows the completed test strip cut into three sections and identified for the parties involved as per the CQC/CQA Documents. For geomembranes that are seamed by extrusion or thermal methods the seams can be tested after they are allowed to cool in ambient air at least 5 to 10 minutes prior to peel and shear testing.

As previously stated, all seam test samples must be prepared in triplicate sets from a single continuous test strip which can be cut into thirds; one set for CQC tests, one set for CQA tests and one set made available to (or retained for) the agency/owner/design organization. If referee test results are required, CQA test results from destructive testing of actual seam samples will prevail.

During the CQC and CQA test evaluation periods, a liner should not be covered and it cannot be placed into service. This will insure that it is available for repairing or reconstructing in the event it is required. During this period it is imperative that the liner be properly ballasted or otherwise secured so as to prevent wind or unusual weather damage.

5.4 ACTUAL SEAMING PROCESS

- (a) Whenever HDPE geomembranes are 1.5 mm (60 mils) in thickness or greater, the leading edge of the upper sheet must be ground to a 45° bevel. It is important that the sheet to be beveled is lifted up off the lower sheet so that no grind marks whatsoever occur in the lower sheet outside of the area to be seamed, see Figure 5.6. Note that grinding should be done prior to tack welding in order to exercise control against damage to the lower sheet.



Figure 5.5(a). A polyethylene geomembrane sample being cut into two sections for fabrication of the test strip.

Figure 5.5(b). The two sections of geomembrane being hot air "tacked" so as to maintain their proper positioning and preventing movement during seaming.



Figure 5.5(c). Grinding of geomembrane surfaces to remove surface oxides and waxes.

Figure 5.5(d). Placement of extrudate on the prepared polyethylene geomembrane surface. Movement is from left to right in the photograph.



Figure 5.5(e). The completed test strip has been cut into three sections and identified for the parties involved to destructively test or archive.

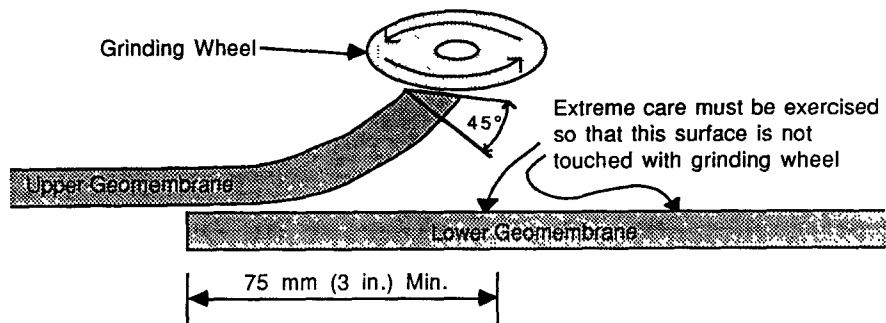

Figure 5.6. Preparing the bevel of the upper geomembrane for liner thicknesses greater than 1.5 mm (60 mil.)

- (b) Following the preparation of the bevel, the upper sheet is lowered and laid flat on the lower sheet and the horizontal surface grinding of both upper and lower sheets is completed as shown in Figure 5.7. All of the surface sheen in the area to be seamed must be totally removed. Heavy textured grit sand papers coarser than #80 size that leaves deep grooves that might become stress points or leak channels are unacceptable. All of the material that has been ground from the geomembrane sheets must be wiped or blown away from the actual seaming zone.

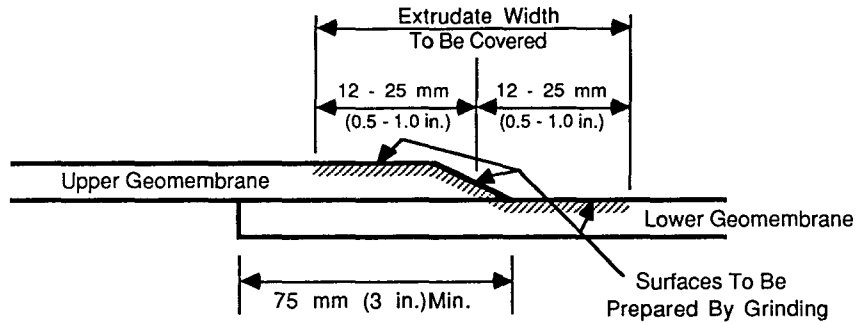

Figure 5.7. Proper orientation and grinding preparation of sheets prior to tacking and extrudate placement.

- (c) The preferred orientation of grinding marks is perpendicular to the seam direction rather than parallel to it. It should be mentioned that this is a slow process for the installation contractor to perform. The reasoning against parallel grinding is that deep, parallel grooves decrease parent material thickness in the direction of stress application across the seam and can lead to seam failure in the parent material. Although the film tearing bond criterion is usually satisfied, it is often at a reduced stress due to the thinner material, see Figure 5.8 for the distinction between the two different orientation patterns. Please note that both grinding patterns in Figure 5.8 are excessive and improper in their extent beyond the extrudate and are shown for illustration purposes only.
- (d) The depth of the grinding marks (whatever the direction) is of paramount interest. Initial grinding depths should be targeted to be less than 5% of the sheet thickness. Areas where grinding depths are greater than 10% should not be incorporated into the seam. The objective of grinding is to remove oxidized layers and waxes from the geomembrane surfaces and to roughen the seam areas of the sheets for bonding to the extrudate. The grinding should yield a fine grained smooth surface. The amount of material

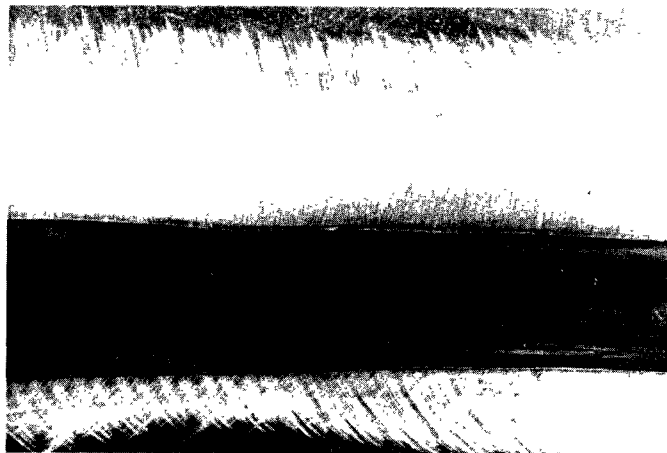

Figure 5.8. Photographs of different orientations of grinding patterns.
Upper: Grind marks perpendicular to seams (recommended pattern)
Lower: Grind marks parallel to seam (not recommended pattern)

(Note, however, that both situations have grinding far in excess of what is required and are shown for illustration of the grinding patterns only, see Figure 5.9 following).

removed by grinding should be minimal as only a nominal amount of sheeting needs to be removed to achieve a new surface. Should grind depth exceed 10% of sheet thickness, then the seam area must be adjusted such that improperly ground area is not involved in the seam or that improperly ground area should be physically removed.

- (e) Regarding the extent of the grinding, the general rule should be that grinding marks should not appear beyond 0.6 cm (1/4 inch) of the extrudate after it is placed, see Figure 5.9. Thus, if the final extrudate bead width is 4.0 cm (1.5 in.) in width, the total grinding pattern should be no more than 5.0 cm (2.0 in.), which is equidistant on each side of the weld centerline.
- (f) Grinding shall be completed no more than 10 minutes before seaming takes place so that oxidized surface layers are not recreated prior to placement of the extrudate and to prevent dirt from embedding itself in the patterned grooves.
- (g) The hand held grinder used for the grinding process must be turned off whenever it is not in use. Never leave it running. If it contacts the liner while running it will cause serious damage.
- (h) Note that if the temporary tacking (refer to Section 5.2) is done before the beveling and grinding operations described in steps (a) through (g), then extreme caution against overgrinding and mistakes must be taken. It might be necessary to provide a wedge to lift up the overlying geomembrane as shown in Figure 5.10, or to use a thin metal sheet with rounded corners and slide it along the grinding area on top of the bottom sheet. If double sided tape is used for temporary tacking, it should be placed far enough from the edges to not interfere with the fusion process.
- (i) The extrusion welder is to be purged of all aged extrudate in the barrel prior to beginning a seam. This must be done every time the extruder is restarted after a 2 min., or longer, period of inactivity. The purged extrudate should not be discharged onto the surface of previously placed liner nor on the prepared subgrade where it would eventually form a hard lump under the liner causing stress concentrations and possibly premature failure.
- (j) Extrudate in the form of a molten, highly viscous fluid is now deposited over the overlapped geomembrane. The center of the extrudate must be located directly over the edge of the upper geomembrane. The extrudate should cover the grind marks on each side of the upper and lower geomembranes to within 0.6 cm (1/4 inch) of the outside borders.

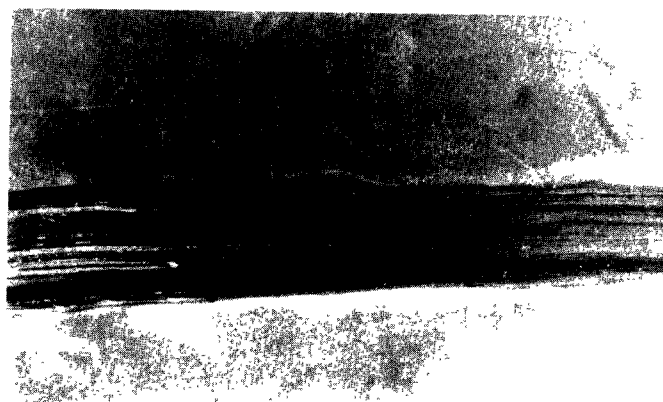

Figure 5.9. Photographs of different extent of grinding patterns after extrusion fillet seaming.
Upper: Excessive and irregular grinding beyond extrudate.
Lower: Acceptable grinding pattern just showing beyond extrudate.

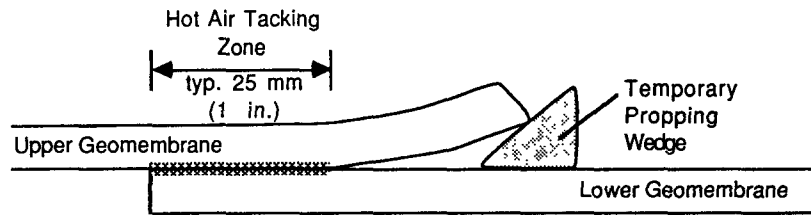

Figure 5.10. Smooth propping wedge used when tacking of sheets is done before surface grinding of the geomembrane sheets.

- (k) The extrudate thickness should be approximately equal to or greater than the specified sheet thickness measured from the top of the upper sheet to the top or crown of the extrudate, see Figure 5.11. Excessive squeeze-out (or flashing) as shown in the lower sketch of Figure 5.11 is acceptable as long as it is properly joined with the geomembrane, symmetric and will not interfere with subsequent vacuum box testing. If, however, pulling up on the extrudate squeeze-out pulls the entire extrudate off the sheet it is obviously unacceptable. Squeeze-out generally means that the extrusion die was not riding directly against the geomembrane, the extrudate temperature was improper for adequate flow, or the seaming rate was too slow.

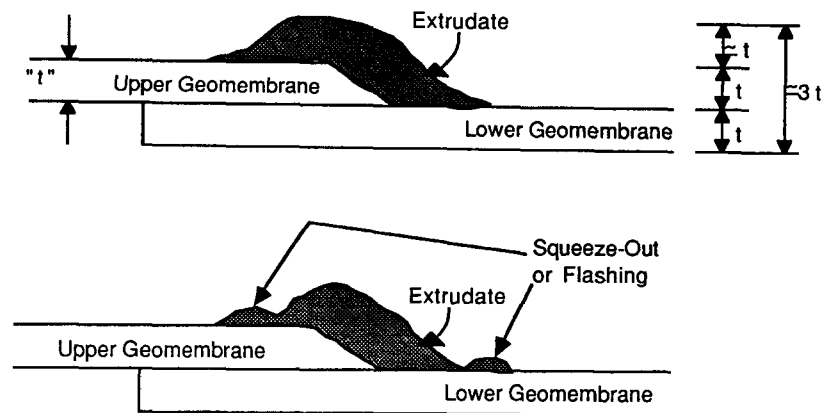

Figure 5.11. Schematic diagrams of various cross sections of extrusion fillet seams.

- (l) Where possible, inspect the underside of the lower geomembrane for heat distortion. This can be done at the end of seams and where samples are cut out of the seam. If the underside is greatly distorted, lower the temperature or increase the rate of seaming. For thick HDPE geomembranes of 2 mm (80 mils) or greater there should never be any indication of this type of thermal "puckering". VLDPE seams which receive too much heat during seaming will exhibit an increase in the amount of waves visible along the length of the seam.
- (m) If properly planned, each seam run should terminate at a panel end, at a specific detail or on a long straight run where it can be easily resumed.
- (n) If the seaming needs to be interrupted at mid-seam, the extrudate should end abruptly, with the extrudate being no thicker than in a normal weld, rather than terminate with a large mass of solidified extrudate.
- (o) Where extrusion fillet welds are temporarily terminated long enough to cool, they must be ground prior to applying new extrudate over the existing seam. This restart procedure must necessarily be followed on patches, pipes, fittings, appurtenances and "T" or "Y" shaped seams.
- (p) Depending upon the records to be kept, one might record a number of different temperatures and/or the rate of seaming. This is a site specific decision usually determined by the contract specification or CQC/CQA Documents.

5.5 AFTER SEAMING

- (a) A smooth insulating plate or heat insulating fabric is always to be placed beneath the hot extrusion welding apparatus after usage. The tip die and barrel must not be placed on any geomembrane or other geosynthetic surface - it is extremely hot and can cause severe damage.
- (b) Visual inspection of the extrudate bead should be made particularly for straight line alignment, height, and uniformity of surface texture. There should be no bubbles or pock marks in the extrudate. Such surface details on the extrudate indicates the presence of air, water or debris within the extrudate rod or pelletized polymer.
- (c) Grind marks should only be visible for 0.6 cm (1/4 inch) beyond the extrudate. They should be extremely faint and never appear as heavy gouge marks, recall Figures 5.8 and 5.9. Excessive grinding also has a depth consideration. As stated previously, excessive is considered to be greater than 10% of the geomembrane thickness. If it is excessive, it is not acceptable to apply additional

extrudate over the original extrusion fillet seam. It is necessary to place a cap strip over the entire seam where the excessive grinding is observed.

- (d) The seam must be checked visually for uniformity of width and surface continuity. Usually the installer will use a vacuum box to check for voids or gaps in the seam.
- (e) When unbonded areas are located, they should be patched with at least 15 cm (6 inches) of geomembrane extending on all sides.
- (f) Any area of the geomembrane where puncture holes are observed must be patched as above with at least 15 cm (6 inches) of geomembrane extending beyond the affected areas.
- (g) Photographs of various types of extrusion fillet seams follow in Figure 5.12.

5.6 UNUSUAL CONDITIONS

This section is written to give insight into conditions which go beyond the general description just presented.

- (a) High winds, or gusts of wind, are always problematic for the liner installation process. After deploying the geomembrane, the panels or rolls must be adequately ballasted with sandbags. The actual seam fabrication, however, will require the removal of some of the sandbags leaving the windward edge vulnerable to wind uplift forces. If possible, proper orientation of the overlap might be helpful. Otherwise, additional labor must be on hand to only remove sandbags immediately in front of the seaming operation. The liner must be cleaned of any dirt and moisture left behind after sandbag removal. They are then to be replaced behind the completed seaming operation.
- (b) Patches are necessary at locations where destructive test samples are removed or where seams are shown to fail nondestructive testing. These patches must extend a minimum of 15 cm (6 inches) beyond the outer limits of the area to be repaired. For HDPE liners the only method available is a hand held extrusion fillet procedure as described in this section. Particular care must be exercised when the end of the extrudate meets the beginning of the circumferential patching run. The double heat that the polymer will necessarily experience cannot be excessive, i.e., a large mass of extrudate should not be visible at this location. For VLDPE hot air seaming can be used to install patches.
- (c) Details around sumps, pipes and other appurtenances for HDPE and VLDPE liners are generally made by hand-held extrusion fillet procedures as described in this section. They are perhaps the most critical seams in a facility. Also due to their typical



Figure 5.12. Photographs of cross sections of various types of HDPE extrusion fillet seams.
Upper: Machine extrusion seam without squeeze-out.
Middle: Hand held extrusion seam without squeeze-out (note thermal puckering at bottom at seam).
Lower: Hand held extrusion seam with squeeze-out.

locations being at low points of the containment facility's design, these areas inherently operate under larger hydraulic heads. Should a defect from improper seaming occur in such a location leakage rates and its associated adverse impacts are heightened. Therefore, extreme care should be exercised in ensuring seam integrity in these often difficult to reach locations. The extrudate should be symmetric on both sheets to be joined which is difficult for external and internal edges and particularly at corners. The end of the seam run, where it joins to the beginning, should be a smooth transition and not end with a large mass of extrudate.

- (d) This section was written for material temperatures that range between 0°C (32°F) and 50°C (122°F), which is the temperature range that is generally recognized as being acceptable for seaming without taking special precautions. For sheet temperatures below 0°C (32°F), shielding, pre-heating, and/or a slower seaming rate may be required. More frequent seam testing and precautions to prevent thawing subgrade may have to be taken. Sharp, frozen subgrade should be avoided to eliminate point pressure damage potential.

For sheet temperatures above 50°C (122°F), shielding and rate of seaming should be adjusted. More frequent destructive seam testing may have to be taken.

FIELD NOTES:



SECTION 6

DETAILS OF EXTRUSION FLAT SEAMS

As seen in Table 4.2, extrusion flat seaming is an applicable method for the seaming HDPE and VLDPE geomembranes. Thus, this section is written primarily for HDPE and VLDPE liners.

6.1 GEOMEMBRANE PREPARATION

- (a) Note, that this document assumes that the proper geomembrane has been visually inspected to ensure it is free of deep scratches, or defects that would cause the sheet to not meet the specifications of the installation. It is further assumed the sheet has been delivered to the site and brought to its approximate plan position for final installation and seaming. Only the material that can be seamed that day should be deployed. All deployed material should be adequately ballasted immediately to prevent wind uplift.
- (b) The geomembrane, HDPE or VLDPE, will usually arrive on site in rolls.
- (c) The geomembrane should remain packaged or rolled and dry until ready to use. The material should not be unrolled if the material temperatures are lower than -10°C (14°F) due to the possibility of cracking. If the panel is stored in a warm place, e.g. 10°C (50°F) or above, prior to being unrolled on site, then it can be placed at -18°C (0°F) or below temperatures providing the time between removing the geomembrane from storage and deployment does not exceed one-half working day.
- (d) The two geomembrane sheets to be joined must be properly positioned such that approximately 7.5 cm to 15.0 cm (3 to 6 inches) of overlap exists.
- (e) All personnel walking on the geomembrane should have smooth soled shoes. Heavy equipment, e.g. pickups, tractors, etc., should not be allowed on the geomembrane at any time, unless otherwise specified by the manufacturer and approved in the CQC/CQA Documents.
- (f) If the overlap is insufficient, lift the geomembrane sheet up to allow air beneath it and "float" it into proper position. Avoid dragging polyethylene geomembrane sheets particularly when they are on rough soil subgrades since scratches in the material may create various stress points of different depths and orientations.

- (g) If the overlap is excessive and is to be removed it should be done by trimming the lower sheet only. If this is not possible and the upper sheet must be trimmed do not use a knife with an unshielded blade to cut off the excessive amount because the blade facing downward can easily scratch the underlying geomembrane in a very vulnerable location. A shielded blade or a hook blade should be used to trim off the excess geomembrane. A photograph of such a device is shown in Figure 6.1. Whenever possible it should be used from beneath the liner in an upward cutting motion.
- (h) All cutting and preparation of odd shaped sections or small fitted pieces should be completed at least 15 m (50 ft.) ahead of the seaming operation so that seaming may be continued with as few interruptions as possible.
- (i) Visually check the two opposing geomembrane sheets to be joined for defects of sufficient magnitude to affect seam quality. The criteria to be met and the procedures to be used in this regard should be stipulated in the contract specifications and/or in the CQC/CQA Documents.
- (j) If the Plans require overlaps to be shingled in a particular direction this should be checked.
- (k) Excessive undulations (waves) along the seams during the seaming operation should be avoided. When this occurs due to either the upper or lower sheet having more slack than the other or because of thermal expansion and contraction, it often leads to the undesirable formation of "fishmouths" which must be trimmed, laid flat and reseamed with a patch.
- (l) There should be some slack in the installed liner which depends on the type of geomembrane, the ambient and anticipated service temperatures, length of time the geomembrane will be exposed, location in the facility, etc. This is a design consideration and the Plans and Specifications must be project specific on the amount and orientation of slack.
- (m) The sheets which are overlapped for seaming must be clean. If dirty, they must be wiped clean with dry rags or other appropriate materials.
- (n) The sheets which are overlapped for seaming must be completely free of moisture in the area of the seam. In the case of moisture air blowers are usually preferred over rags for drying the membrane.



Figure 6.1. Type of hook blade used in the cutting of liner materials.

- (o) Seaming is not allowed during rain or snow, unless proper precautions are made to allow the seam to be made on dry geomembrane materials, e.g., within an enclosure or shelter.
- (p) It is preferable not to have water-saturated soil beneath the geomembrane during installation. Seaming boards help in this regard by lifting the seams off the soil subgrade.
- (q) If the soil beneath the geomembrane is frozen, the heat of seaming can thaw the frost allowing water to be condensed onto the unbonded region ahead of the seam being fabricated. This possibility may be eliminated by the use of suitable seaming boards or slip sheets made from excess pieces of geomembrane.
- (r) The temperature of the geomembrane for seaming should be above freezing, i.e. 0°C (32°F) unless it can be proven with a test strips that good seams can be fabricated at lower temperatures. However, temperature is less a concern to good seam quality than is moisture.
- (s) For cold weather seaming, it may be advisable to preheat the sheets with a hot air blower, to use a tent of some sort to prevent heat losses during seaming and to make numerous test strips in order to determine appropriate seaming conditions, e.g., equipment temperatures may have to be set higher and/or seaming rates slowed down during cold weather seaming.

- (t) Sheet temperatures for seaming should be below 50°C (122°F) as measured by an infrared thermometer or surface contact thermocouple. It is recognized that depending on material type and thickness, higher temperatures may be allowed. It should also be recognized that wind and cloud cover will determine the actual sheet temperature. High temperatures affect not only worker performance but will also affect durability of some geomembranes unless special precautions, e.g. tents, etc., are taken. For temperatures above this value special attention should be paid to the seaming operation. Frequent test strips and more diligent nondestructive testing is recommended.

NOTE: For items (q), (r), (s.) and (t) the CQC/CQA Documents and/or project specifications and the regulatory requirements regarding hot and cold temperature seaming limitations should be reviewed to avoid possible problems with final construction certification acceptance.

6.2 EQUIPMENT PREPARATION

- (a) Properly functioning portable electric generators must be available within close proximity of the seaming region and with adequate extension cords to complete the entire seam. These generators should be of sufficient size or numbers to handle all seaming electrical requirements. The generator must have rubber tires, or be placed on a smooth plate such that it is completely stable so that no damage can occur to the geomembrane or to the underlying liner or subgrade material. Fuel (gasoline or diesel) for the generator must be stored away from the geomembrane and if accidentally spilled on the geomembrane must be immediately removed. The area should be inspected for damage to the geomembrane and repaired if necessary.
- (b) An electric rotary grinder having a grinding disk of approximately 10 cm (4 inch) in diameter and a sufficient quantity of #80 grit paper must be available. Also acceptable is #100 grit paper which is finer than #80. Sandpaper coarser than #80, e.g. #60, is not acceptable. Grinding locations are shown in Figure 6.2. Caution should be used to prevent overgrinding.
- (c) Pressure rollers should be inspected for sharp edges or irregular surfaces. On some systems these rollers are in tandem where the front set (nearest the extrudate) should be adjusted to a lower pressure than the rear set.
- (d) All extrusion flat seaming devices must be equipped with properly functioning temperature controllers displaying the temperature in the extrusion barrel so that it may be monitored by seaming personnel. It is recommended that the temperature of the extrudate with an external thermocouple inserted into the melt stream be periodically made to check the reading of the thermocouple permanently mounted on the barrel. The CQC/CQA Documents should be reviewed for appropriate temperature ranges.

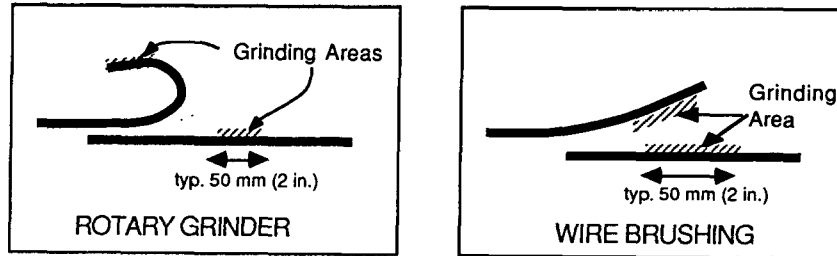

Figure 6.2. Grinding locations and method used in the preparation of extrusion flat seams.

- (e) Adequate extrudate welding rods or pellets of appropriate dimension, and of the same composition as the geomembrane itself, must be used. They must be dry and clean to feed through the extruder. All extrudate resin must be properly formulated so as to be the same compound as the geomembrane sheet material. Manufacturers may be required to provide a certification letter indicating that the welding rod or pellets and the sheet are the same compound. If in doubt, chemical fingerprinting methods must be performed, see Reference 7. All extrudate material must be kept dry and free of dirt, debris and foreign matter. When welding rod is used the size must be consistent and appropriate for the seaming device.

6.3 TEST STRIPS

A general requirement of most CQA Documents is that "test seams" or "test strips" be made on a periodic basis. Test strips generally reflect the quality of field seams but should never be used solely for final field seam acceptance. Final field seam acceptance should be specified in the contract specification and should include a minimum level of destructive testing of the production field seams. Test strips are made to minimize the amount of destructive sampling/testing which requires subsequent repair of the final field seam. Typically these test seams, for each seaming crew, are made about every four hours, or every time equipment is changed, or if significant changes in geomembrane temperature are observed, or as required in the contract specification. This is a recommended practice that should be followed when seaming all types of geomembranes. The purpose of these tests is to establish that proper seaming materials, temperatures, pressures, rates, and techniques along with the necessary geomembrane pre-seaming preparation is being accomplished. Test strips may be used for CQA/CQC evaluation, archiving, for exposure tests, etc., and must be of sufficient length to satisfy these various needs.

Each seaming crew and the materials they are using must be traceable and identifiable to their test seams. While the test seams are being prepared, cured, and CQC tested, the seaming crew may continue to work as long as the seams they have made (and are making) since their last acceptable test sample strip was prepared, are completely traceable and identifiable. If a test seam fails to meet the field seam design specification, then an additional test seam sample will have to be made by the same seaming crew - using the same tools, equipment and seaming materials - and retested.

The liner's finished field seams will not be accepted unless the before and after "test seam sample strip" CQC test results (or other CQC seam test result criteria as required per the design specification) are acceptable per the site's design specifications. If a seam is not accepted, destructive testing of samples from the actual seam will be removed from the liner and tested. If the actual seam destructive test results still do not meet the design specification requirement, then the unacceptable seams will all have to be repaired or reconstructed with seaming materials by a test proven seaming crew that has passed its testing requirements. The procedure illustrated in the flow chart of Figure 6.3 must be followed. Note that the failure of test strip 1 requires two actions: (a) the making of test strip 2, and (b) an increased frequency of destructive tests on production field seams made during the curing of test strip 1 (if any were made). This increased frequency must be stipulated in the contract specifications or in the CQC/CQA Documents.

If the destructive seams fail or if test strip 2 fails, production field seaming is halted. All production field seams made during the interval are repaired per the contract specifications or CQC/CQA Documents to the point of previous acceptance with an approved seaming crew.

At this point, the seaming crew that failed to pass both strip tests must adjust and recertify current seaming equipment and technique or obtain new seaming equipment, tools and/or retrain personnel and begin making initial test strip samples.

Test strips are prepared as shown in Figure 6.4. Figure 6.4(a) shows the flat extrusion device from a side view and Figure 6.4(b) from a rear view. The test strips are made on small sections of excess geomembrane in the identical manner of making actual production seams. When they cool, they are cut into sections and properly identified. For geomembranes that are seamed by extrusion or thermal methods, the seams can be tested after they are allowed to cool in ambient air at least 5-10 minutes prior to peel and shear testing.

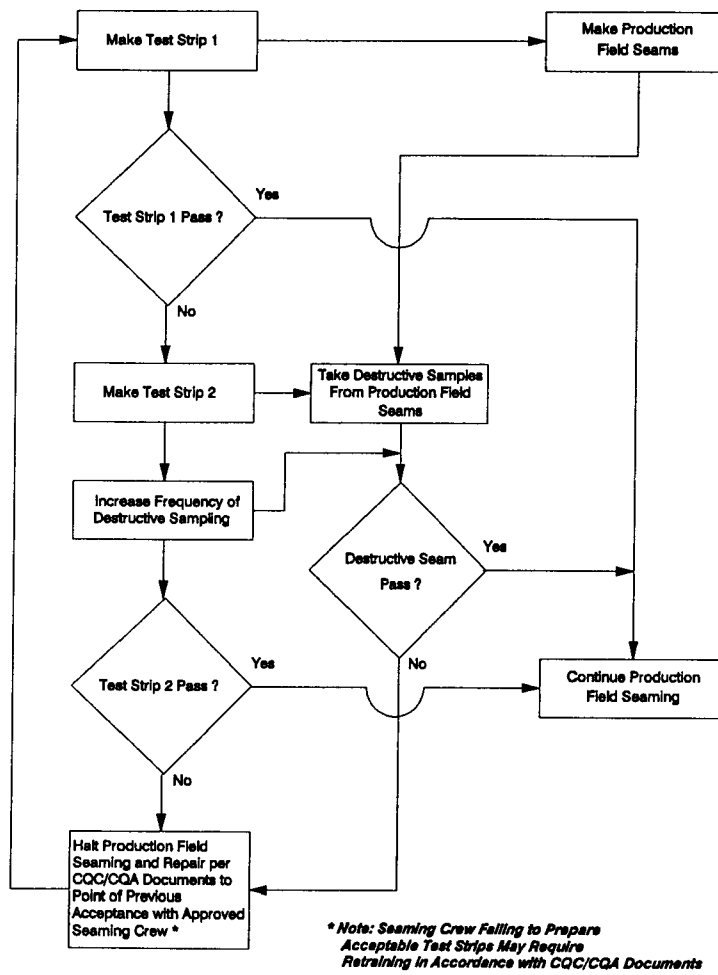

Figure 6.3. Test strip process flow chart.



Figure 6.4(a). Side view of an extrusion flat welding device showing the extrudate feed arm between the overlapping geomembrane sheets and the roller immediately behind.

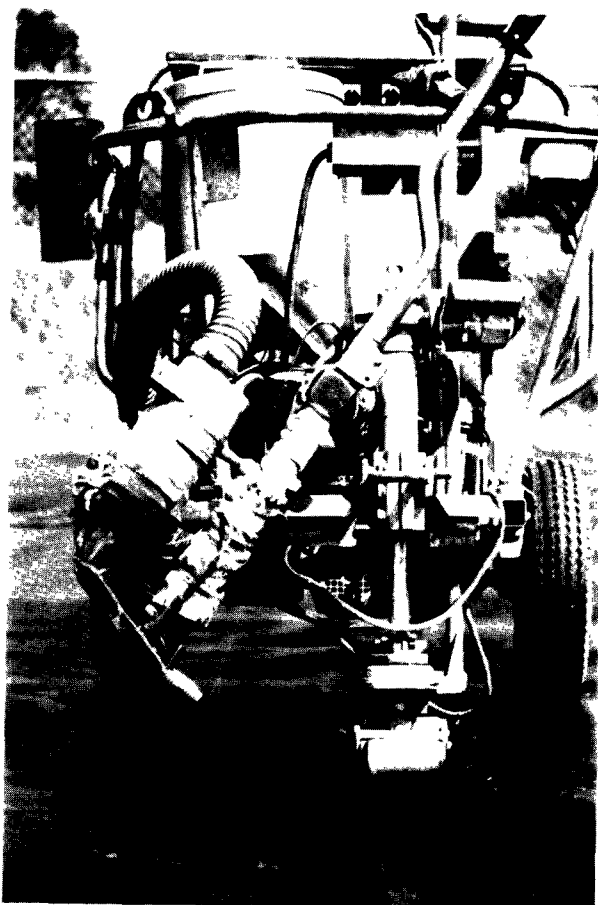

Figure 6.4(b). Rear view of the extrusion flat device as it would appear at the completion of the seam.

As previously stated, all seam test samples must be prepared in triplicate sets from a single continuous test strip which can be cut in thirds; one set for CQC tests, one set for CQA tests and one set made available to (or retained for) the agency/owner/design organization. If referee test results are required, CQA test results from destructive testing of actual seam samples will prevail.

During the CQC and CQA test requirement periods, a liner should not be covered and it cannot be placed into service. This will insure repairing or reconstructing in the event it is required. During this period it is imperative that the liner be properly ballasted and otherwise secured so as to prevent wind or unusual weather damage.

6.4 ACTUAL SEAMING PROCESS

- (a) Either by surface grinding, preheating air or preheating wedge, the area to be seamed should now be ready to accept the extrudate in the form of a ribbon placed between the two sheets.
- (b) If grinding is required, the grinding of the lower sheet is to be done first, with a suitable width (approximately 5.0 to 7.5 cm [2 to 3 inches]) being prepared such that surface oxide is removed and the sheet is roughened. The depth of the grind marks must be no greater than 10% of the original thickness of the sheet. Initial grinding depths should be targeted to be less than 5% of the sheet thickness. Areas where grinding depths are greater than 10% should not be incorporated into the seam.
- (c) The upper sheet is bent over backwards but not creased, so that its underside can be ground at the location where it will meet the lower sheet's prepared surface. It is important to note that all ground sheet must eventually be covered with extrudate to within 0.6 cm (1/4 inch).
- (d) Alternatively to the type of surface preparation just described in parts (b), and (d), an automated wire brush technique can be used. With this instrument it is possible to prepare the bottom of the top sheet and the top of the bottom sheet at the same time, see Figure 6.2. It should be noted that an even surface must be prepared. The surfaces should be inspected for uniformity and grinding depths less than or equal to 10% of the sheet thickness.
- (e) If the flat extrusion device is equipped with pre-heating air or pre-heating wedge preceding the extrudate, grinding of either type just described is not necessary. It must be shown, however, by the use of test strips that these techniques do, indeed, provide adequate seam strength in shear and in peel testing.

- (f) Preheating of the opposing surfaces with hot air or hot wedge devices must be applied to the full seam width at a constant temperature. The nozzle, or wedge, should be inspected for obstructions or scratches on a daily basis. Care should be taken in choosing the nozzle design and magnitude of the air pressure. If excessive air is discharged under the top geomembrane it could create a backpressure that may blow dust and small soil particles into the seam area.
- (g) The extrusion welder is to be purged of all heat-degraded extrudate in the barrel prior to beginning a seam. This must be done every time the extruder is restarted after a 2 min., or longer, period of inactivity. The purged extrudate should not be discharged onto the surface of previously placed liner nor on the prepared subgrade where it would eventually form a hard lump under the liner causing stress concentrations and possibly premature failure.
- (h) Some extrudate should also be ejected to see if the nozzle is the appropriate width and thickness. Usually flat extrudate ribbons are 3.8 to 5.0 cm (1.5 in. to 2.0 in.) wide and about 1.5 mm (60 mils) thick. However, welding speed will affect this thickness, which ranges from about 0.5 mm (20 mils) thick when moving rapidly, to 2.0 mm (80 mils) thick when moving slowly. Properly functioning temperature controllers must display the extrudate temperature. A photograph and schematic diagram of a extrusion flat seaming device is given in Figure 6.5.
- (i) The extrudate is placed at about (250°C) 480°F in a full width, full thickness ribbon, see Figure 6.6. It cannot be visually inspected since it is occurring between the two sheets, directly following the sheet preparation by grinding, preheating air or preheating wedge and directly preceding the pressure rollers.
- (j) The outside edge of the seam should be visually observed to ensure that the extrudate is embedded between the liner sheets. Three cases are possible. These are: 1) the edge of the extrudate being somewhat under the overlapping sheet, 2) exactly even with it, or 3) beyond it in the form of "squeeze-out". Either one of the latter two situations are necessary if vacuum box testing of the seam is subsequently required.
- (k) The rollers exert considerable pressure and are adjusted according to sheet thickness. Indentations on the surface of the upper geomembrane should be observable but should not create a rut, e.g., the indentation should be barely capable of being felt.

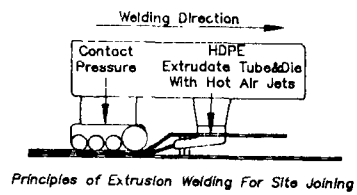

Figure 6.5. Photographs and schematic diagram of extrusion flat seaming of geomembrane sheets.

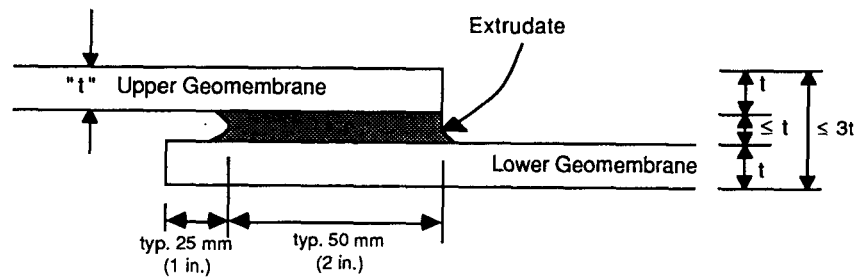

Figure 6.6. Schematic diagram of cross section of extrusion flat seam with extrudate out to the edge of the upper geomembrane.

- (l) Thermal "puckering" of the upper surface of the overlying geomembrane should not appear. Although the lower surface of the underlying geomembrane is rarely able to be inspected (except at sheet ends, trial strips, or where samples are taken) it should not be puckered. Thermal puckering signifies excessive heat and/or insufficient seaming rate.
- (m) Depending upon the records to be kept, one might record a number of different temperatures and/or the rate of seaming. This is a site specific decision usually determined by the contract specification or CQC/CQA Documents.
- (n) It is necessary that the operator keep constant visual contact with the temperature controls, as well as the completed seam coming out of the machine. Occasional adjustments of temperature or speed as the result of changing ambient conditions will be necessary to maintain a consistent seam. Constant visual and hands on inspection is also recommended. If changes in the welding conditions are made as a response to a changing welding environment, an additional destructive sample test should be performed shortly after the change is made.

6.5 AFTER SEAMING

- (a) Hand-held grinders or mechanical wire brushes are always to be turned off when not in use. If placed on the geomembrane while running, they can cause considerable damage.
- (b) A smooth insulating plate or heat insulating fabric is to be placed beneath any hot welding apparatus after usage.

- (c) Grinding marks on the lower sheet of the completed seam should be observable but only for a distance of 0.6 cm (1/4 inch) beyond the extrudate. Note, however, that only the lower sheet can be inspected in this regard.
- (d) If properly planned, each seam run should terminate at a panel end, specific detail or on a long straight run where it can be easily resumed.
- (e) Where extrusion flat welds are terminated long enough to cool, the start-up continuation seam must completely melt the leading edge of the cooled seam. Since this is occurring beneath the overlapped sheet and cannot be observed, the location must be marked for subsequent vacuum box testing. If it fails, the area must be repaired or reconstructed.
- (f) The extrudate end should trail off gradually, rather than terminate with a large mass of solidified extrudate.
- (g) The seam must be checked visually for uniformity of width and surface continuity. Usually the installer will use a vacuum box to check for voids or gaps in the seam.
- (h) When unbonded areas are located, they should be patched with at least 15 cm (6 inches) of geomembrane extending on all sides. Any area of the geomembrane where puncture holes are observed must be patched as above with at least 15 cm (6 inches) of geomembrane extending beyond the affected areas. If grinding is to be performed to prepare the geomembrane, review instructions provided in Section 5.
- (i) Photographs of the various types of extrusion flat seams are shown in Figure 6.7.

6.6 UNUSUAL CONDITIONS

This section is written to give insight into conditions which go beyond the general description just presented.

- (a) High winds, or gusts of wind, are always problematic for liners. After deploying the geomembrane, the panels must be adequately ballasted with sandbags. The actual seam fabrication, however, will require the removal of some of the sandbags leaving the windward edge vulnerable to wind uplift forces. If possible, proper orientation of the overlap might be helpful. Otherwise, additional labor must be on hand to only remove sandbags immediately in front of the seaming operation. The liner must be cleaned of any dirt and moisture left behind after sandbag removal. They are then to be replaced behind the completed seaming operation.



Figure 6.7. Photographs of cross sections of HDPE extrusion flat seams.
Upper: Extrudate short of edge of overlapping sheet.
Middle: Extrudate exactly at the edge of overlapping sheet.
Lower: Extrudate squeeze-out beyond the edge of overlapping sheet.

- (b) Patches are necessary at locations where destructive test samples are removed or where seams are shown to fail nondestructive testing. These patches must extend a minimum of 15 cm (6 inches) beyond the outer limits of the area to be repaired. For HDPE liners the only method available is a hand held extrusion fillet procedure as described in Section 5. Particular care must be exercised when the end of the extrudate meets the beginning of the run. The double heat that the polymer will necessarily experience cannot be excessive, i.e., a large mass of extrudate should not be visible at this location.
- (c) Details around sumps, pipes and other appurtenances for HDPE and VLDPE liners must necessarily be made by hand-held extrusion fillet procedures as described in Section 5. They are perhaps the most demanding seams in a facility. Also due to their typical locations being at low points of the containment facility's design, these areas inherently operate under larger hydraulic heads. Should a defect from improper seaming occur in such a location leakage rates and its associated adverse impacts are heightened. Therefore, extreme care should be exercised in ensuring seam integrity in these often difficult to reach locations. The extrudate should be symmetrical on both sheets to be joined which is difficult for external and internal edges and particularly at corners. The end of the seam run, where it joins to the beginning, should be a smooth transition and not end with a large mass of extrudate.
- (d) This section was written for material temperatures that range between (0°C) 32°F and (50°C) 122°F. This is the temperature range that is generally recognized as being acceptable for seaming without taking special precautions.

For sheet temperatures below 0°C (32°F), shielding, preheating, and/or a slower seaming rate may be required. More frequent seam testing and precautions to prevent thawing subgrade (previously discussed) may have to be taken. Sharp, frozen subgrade should be avoided to eliminate point pressure damage potential.

For sheet temperatures above 50°C (122°F), shielding and rate of seaming should be adjusted. More frequent destructive seam testing may have to be taken.

FIELD NOTES:

FIELD NOTES:



SECTION 7
DETAILS OF HOT WEDGE SEAMS

As seen in Table 4.2, hot wedge seaming is an applicable method for the seaming all thermoplastic geomembranes.

7.1 GEOMEMBRANE PREPARATION

- (a) Note, that this document assumes that the proper geomembrane has been visually inspected to ensure it is free of deep scratches, or defects that would cause the sheet to not meet the specifications of the installation. It is further assumed the sheet has been delivered to the site and brought to its approximate plan position for final installation and seaming. Only the material that can be seamed that day should be deployed. All deployed material should be ballasted as required to prevent wind uplift.
- (b) If the geomembrane is CPE, CPE-R, CSPE-R, EIA, EIA-R, PVC or PVC-R it will usually arrive on site in the form of fabricated panels which are accordion-folded in both directions. They are generally packaged in palletized, heavy cardboard containers. If the geomembrane is HDPE or VLDPE, it will arrive on the site in rolls.
- (c) The geomembrane should remain packaged or rolled and dry until ready to use. The material should not be unfolded or unrolled if the material temperatures are lower than -10°C (14°F) due to the possibility of cracking. If the panel is stored in a warm place, e.g. 10°C (50°F) or above, prior to being unfolded or unrolled on site, then it can be placed at -18°C (0°F) or below temperatures providing the time between removing the geomembrane from storage and deployment does not exceed one-half working day. Geomembrane deployment may be allowed under other conditions but the CQC/CQA Documents and/or project specifications must be specific as to the conditions.
- (d) The two geomembrane sheets to be joined must be properly positioned such that approximately 7.5 cm to 15.0 cm (3 to 6 inches) of overlap exists. All personnel walking on the geomembrane should have smooth soled shoes. Heavy equipment, e.g. pickups, tractors, etc., should not be allowed on the geomembrane at any time, unless otherwise specified by the manufacturer and approved in the CQC/CQA Documents.

- (e) If the overlap is insufficient and it does not fully cover the wedge, lift the geomembrane up to allow air beneath it and "float" it into proper position. Avoid dragging geomembrane sheets made from HDPE particularly when they are on rough soil subgrades since scratches in the material create stress points of different depths and orientations.
- (f) When most reinforced geomembranes are cut to accommodate odd shapes or to fit small pieces, resealing of the exposed scrim by flood coating is required by the use of the manufacturer's or fabricator's approved liquid sealant.
- (g) If the overlap is excessive when placing HDPE and VLDPE and is to be removed, it should be done by trimming the lower sheet. If this is not possible and the upper sheet must be trimmed, do not use a knife with an unshielded blade to cut off the excessive amount because the blade facing downward can easily scratch the underlying geomembrane in a very vulnerable location. A shielded blade or a hook blade should be used to trim off the excess geomembrane. A photograph of such a device is shown in Figure 7.1. Whenever possible it should be used from beneath the liner in an upward cutting motion. For liners made from CPE, CPE-R, CSPE-R, EIA, EIA-R, PVC, PVC-R and VLDPE the excess material can be cut by a scissor or can be worked away from the edges of the seam to maintain proper overlap.
- (h) All cutting and preparation of odd shaped sections or small fitted pieces should be completed at least 15 m (50 ft.) ahead of the seaming operation so that seaming can be completed with as few interruptions as possible.
- (i) The two opposing sheets to be joined should be visually checked for defects of sufficient magnitude to affect seam quality. The criteria to be met and the procedures to be used in this regard should be stipulated in the contract specifications and/or in the CQC/CQA Documents.
- (j) If the construction plans require overlaps to be shingled in a particular direction this should be checked.
- (k) Excessive undulations (waves) along the seams during the seaming operation should be avoided. When this occurs due to either the upper or lower sheet having more slack than the other or because of thermal expansion and contraction, it often leads to the undesirable formation of "fishmouths" which must be trimmed, laid flat and reseamed with a patch.



Figure 7.1. Type of hook blade used in the cutting of liner materials.

- (l) For all liners, there should be some slack in the installed liner which depends on the type of geomembrane, ambient and anticipated service temperatures, length of time the geomembrane will be exposed, location in the facility, etc. This is a design consideration and the Plans and Specifications must be project specific on the amount and orientation of slack.
- (m) The sheets which are overlapped for seaming must be clean. If dirty, they must be cleaned with dry rags or other appropriate materials.
- (n) The sheets which are overlapped for seaming must be free of moisture in the area of the seam.
- (o) Seaming is not allowed during rain or snow, unless proper precautions are made to allow the seam to be made with dry geomembrane materials, e.g., within an enclosure or shelter.
- (p) It is preferable not to have water saturated soil beneath the geomembrane during installation. Seaming boards help in this regard by lifting the seams off the soil subgrade.
- (q) If the soil beneath the geomembrane is frozen, the heat from hot air seaming devices or any preheating lamps that may be used can thaw the frost allowing water to be condensed onto the unbonded

region ahead of the seam being fabricated. This possibility may be eliminated by the use of suitable seaming boards or slip sheets made of excess geomembrane material.

- (r) Ambient temperatures for seaming should be above freezing, i.e., 0°C (32°F) unless it can be proven with test strips that good seams can be fabricated at lower temperatures. However, temperature is less a concern to good seam quality than is moisture.
- (s) For cold weather seaming, it may be advisable to preheat the sheets with a radiant heater or a blower, to use a tent of some sort to prevent heat losses during seaming and to make numerous test strips in order to determine appropriate seaming conditions, e.g., equipment temperatures may have to be set higher and/or seaming rates slowed down during cold weather seaming.
- (t) Sheet temperatures for seaming should be below 50°C (122°F) as measured by an infrared thermometer or surface contact thermocouple. It is recognized that depending on material type and thickness, higher temperatures may be allowed. It should also be recognized that wind and cloud cover will determine the actual sheet temperature. High temperatures affect not only worker performance but may also affect seam durability of some geomembranes unless special precautions are taken. For temperatures above this value, frequent test strips and more diligent nondestructive testing is recommended.
NOTE: For items (q), (r), (s,) and (t) the CQC/CQA Documents and/or project specifications and the regulatory requirements regarding hot and cold temperature seaming limitations should be reviewed to avoid possible problems with final construction certification acceptance.

7.2 EQUIPMENT PREPARATION

- (a) Properly functioning portable electric generators must be available within close proximity of the seaming region and with adequate extension cords to complete the entire seam. These generators should be of sufficient size or numbers to handle all seaming electrical requirements. The generator must have rubber tires, or be placed on a smooth plate such that it is completely stable so that it cannot damage the geomembrane or to the underlying clay liner or subgrade material. Fuel (gasoline or diesel) for the generator must be stored away from the geomembrane, and if accidentally spilled on the geomembrane it must be immediately removed. The areas should be inspected for damage to the geomembrane and repaired if necessary.

- (b) Hot wedge seaming devices are completely self contained systems sometimes referred to as a "mouse" or "hot shoe". Photographs of different types of hot wedge seaming devices are shown in Figure 7.2.
- (c) As the hot wedge method is one of melting the opposing surfaces of the two sheets to be joined, no grinding of sheets is necessary, nor allowed.
- (d) Hot air tacking of the geomembrane sheets as done in extrusion fillet seaming is not possible since the wedge must travel between opposing parallel sheets which are to be joined.
- (e) The hot wedge itself, or "anvil", should be inspected to see that it is uniform and uniformly tapered. Various types are currently available. Some are smooth surfaced while others have patterned ridges in the direction of the seam or at a slight angle. The taper dimensions vary according to different types of machines. The major point for inspection is that no sharp edges should exist wherever the wedge meets geomembrane sheet surfaces.
- (f) A single hot wedge has an anvil which is uniform over its entire surface. A dual wedge has a split anvil forming two separate tracks, see the sketches of Figure 7.3. If a dual, or split, hot wedge seam is being made, the recessed space for the central unseamed portion should be examined to ensure the cavity is clean.
- (g) Knurled rollers are used for applying pressure on the sheets and driving the device. They immediately follow the pointed end of the anvil. The knurled rollers should be inspected to ensure there are no sharp surfaces and that wheels are smoothly beveled on the edges.
- (h) If a chain drive powers the device and applies pressure to the nip/drive rollers it should be inspected for synchronization of travel, proper functioning and fit. Loose chains or damaged sprockets should be repaired or replaced.
- (i) As the geomembrane sheet materials pass through the machine, they must come in contact with the full width of the wedge in order to heat the material uniformly. Idler rollers or similar devices, on both sides of the wedge are adjustable and must make the material conform to the wedge as it passes through the machine. The procedure for doing this with some equipment is as follows: Insert the lower and upper layers of geomembrane material in the nip/drive rollers, which will change the wedge height between the idler rollers. Then, lock the wedge in position, and adjust the idlers so that one layer fits snugly between the wedge and the idlers. The wedge has an adjustment that is actually a stopping device to keep the wedge from being pulled into the nip/drive rollers. Caution must be taken to ensure that the wedge is not

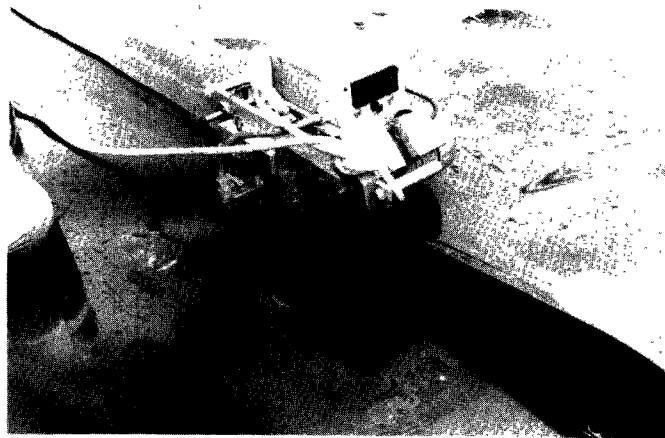
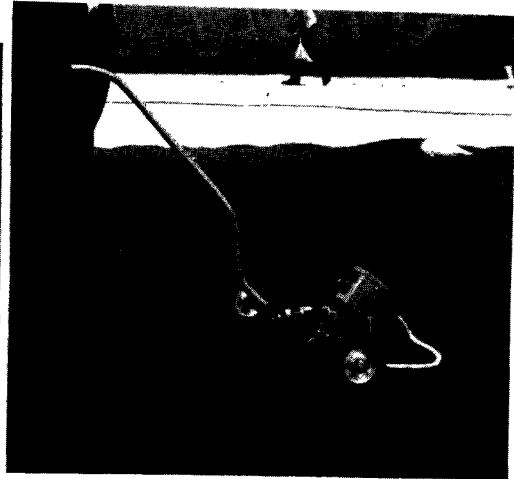
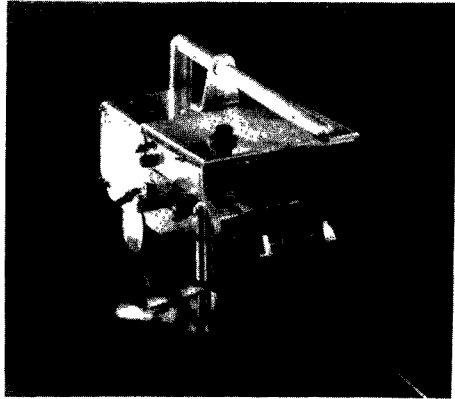

Figure 7.2. Various types of hot wedge seaming devices.

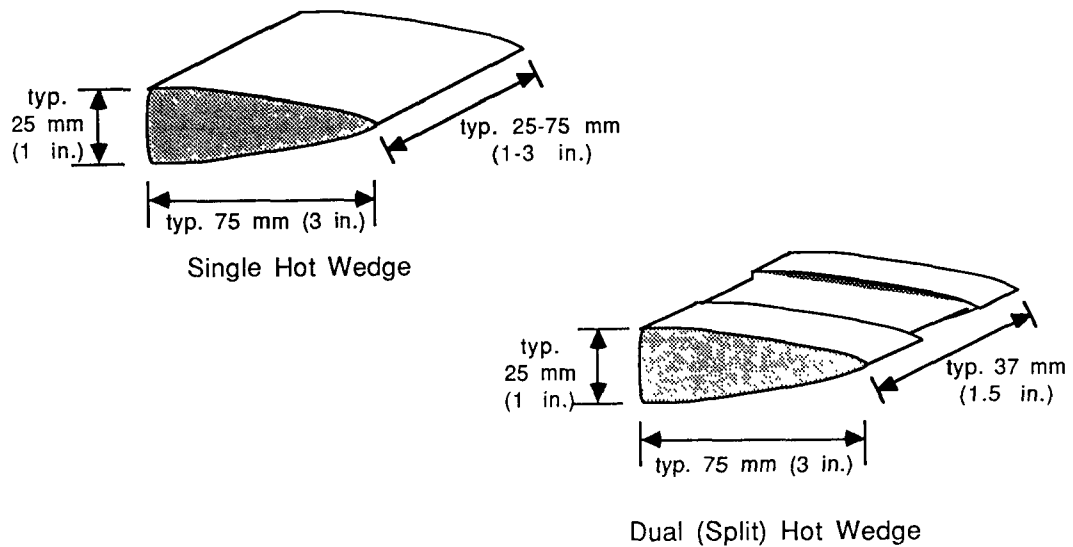

Figure 7.3. Diagrams of the hot wedge elements (i.e., the anvil) upon which the two sheets to be joined are passed.

adjusted too closely to the nip/drive rollers, especially when material is not going through the machine. The drive, or wedge units, must be disengaged before the material runs completely out of the machine. Serious damage will occur to the geomembrane sheets if the wedge gets pulled through the nip/drive rollers.

Please note that there are automatically adjusting machines in use. These machines automatically adjust the position of the geomembrane with respect to the roller drive mechanism. For this reason the above and remaining instructions should be appropriately modified.

- (j) The front part of the seaming device should be inspected for sharp corners and irregular details which may damage the geomembranes.
- (k) Temperature controllers on the wedge device should be set according to type of geomembrane, thickness, ambient temperature, rate of seaming, and location of thermocouple within the device. Temperature gages should be checked for accuracy and repeatability. Table 7.1 gives typical values but this is a site, material and device specific decision usually determined by CQC/CQA Documents or site specific conditions.
- (l) If available, the force sensors at the nip rollers should be checked for accuracy and repeatability.

TABLE 7.1. TEMPERATURE RANGES FOR HOT WEDGE SEAMING OF THERMOPLASTIC GEOMEMBRANES (TEMPERATURES ARE WITHIN THE WEDGE ITSELF).

Geomembrane Type	Minimum * °C (°F)	Maximum ** °C (°F)
CPE	170 (340)	370 (700)
CPE-R	170 (340)	370 (700)
CSPE-R	180 (360)	370 (700)
EIA	155 (310)	175 (345)
EIA-R	155 (310)	175 (345)
HDPE***	315 (600)	455 (850)
PVC	165 (330)	370 (700)
PVC-R	165 (330)	370 (700)
VLDPE***	270 (520)	400 (750)

* For dry, warm weather seaming conditions

** For damp, cold weather seaming conditions

*** For textured or roughened HDPE or VLDPE sheet increase temperatures about 25°C (45°F). Also slower seaming rates and higher pressures may be required.

7.3 TEST STRIPS

A general requirement of most CQA Documents is that "test seams" or "test strips" be made on a periodic basis. Test strips generally reflect the quality of field seams but should never be used solely for final field seam acceptance. Final field seam acceptance should be specified in the contract specification and should include a minimum level of destructive testing of the production field seams. Test strips are made to minimize the amount of destructive sampling/testing which requires subsequent repair of the final field seam. Typically these test seams, for each seaming crew, are made about every four hours, or every time equipment is changed, or if significant changes in geomembrane temperature are observed or, as required in the contract specification. This is a recommended practice that should be followed when seaming all types of geomembranes. The purpose of these tests is to establish that proper seaming materials, temperatures, pressures, rates, and techniques along with the necessary geomembrane pre-seaming preparation is being accomplished. Test strips may be used for CQA/CQC evaluation, archiving, for exposure tests, etc., and must be of sufficient length to satisfy these various needs.

Each seaming crew and the materials they are using must be traceable and identifiable to their test seams. While the test seams are being prepared, cured, and CQC tested, the seaming crew may continue to work as long as the seams they have made (and are making) since their last acceptable test sample strip was prepared, are completely traceable and identifiable. If a test seam fails to meet the field seam design specification, then an additional test seam sample will have to be made by the same seaming crew - using the same tools, equipment and seaming materials - and retested.

The liner's finished field seams will not be accepted unless the before and after "test seam sample strip" CQC test results (or other CQC seam test result criteria as required per the design specification) are acceptable per the site's design specifications. If a seam is not accepted, destructive testing of samples from the actual seam will be removed from the liner and tested. If the actual seam destructive test results still do not meet the design specification requirement, then the unacceptable seams will all have to be repaired or reconstructed with seaming materials by a test proven seaming crew that has passed its testing requirements. The procedure illustrated in the flow chart of Figure 7.4 must be followed. Note that the failure of test strip 1 requires two actions: (a) the making of test strip 2, and (b) an increased frequency of destructive tests on production field seams made during the curing of test strip 1 (if any were made). This increased frequency must be stipulated in the contract specifications or in the CQC/CQA Documents.

If the destructive seams fail or if test strip 2 fails, production field seaming is halted. All production field seams made during the interval are repaired per the contract specifications or CQC/CQA Documents to the point of previous acceptance with an approved seaming crew.

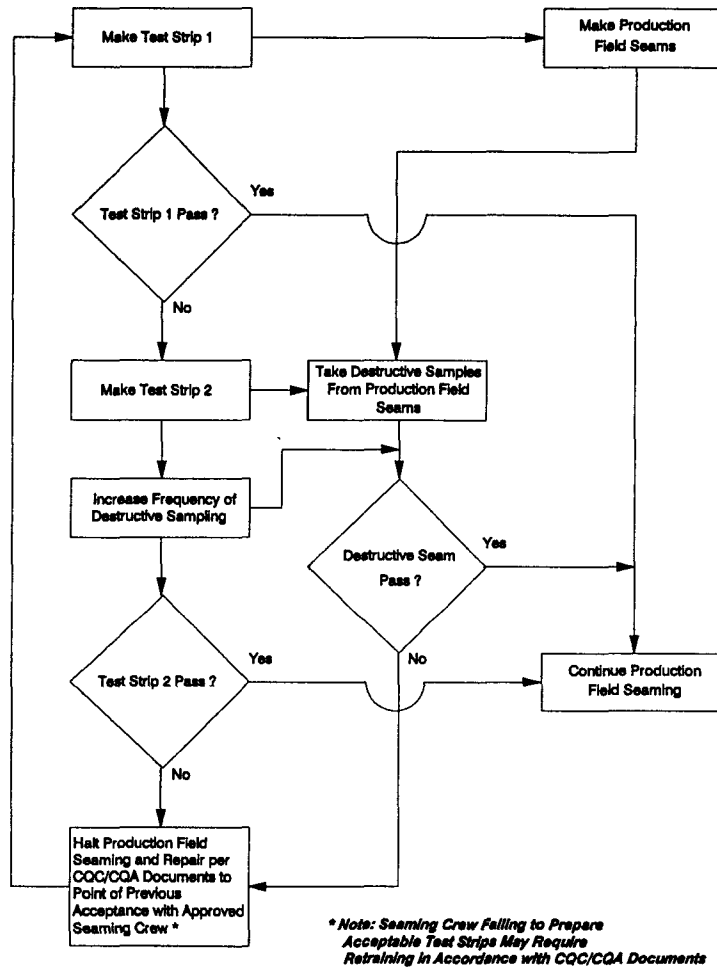

Figure 7.4. Test strip process flow chart.

At this point, the seaming crew that failed to pass both strip tests must adjust and recertify current seaming equipment and technique or obtain new seaming equipment, tools and/or retrain personnel and begin making initial test strip samples.

For hot wedge seams test strips of the type shown in Figure 7.5(a-d) are prepared. The seam is centered lengthwise between the two sheets to be joined. Figure 7.5(a) shows the two geomembrane pieces to be seamed being cleaned and properly aligned, 7.5(b) shows the actual test strip being seamed, 7.5(c) shows the sampling of the test strip for subsequent destructive testing, and 7.5(d) shows the individual samples cut from the test strip being identified. For geomembranes that are seamed by thermal methods, the seams can be tested after they are allowed to cool in ambient air at least 5-10 minutes prior to shear and peel testing.

As previously stated, all seam test samples must be prepared in triplicate sets preferably in a continuous seam which can be cut in thirds; one set for CQC tests, one set for CQA tests and one set made available to (or retained for) the agency/owner/design organization. If referee test results are required, CQA test results from destructive testing of actual seam samples will prevail.

During the CQC and CQA test requirement periods, a liner should not be covered and it cannot be placed into service. This will insure the ease and viability of repairing or reconstructing in the event it is required. During this period it is imperative that the liner be properly ballasted and otherwise secured so as to prevent wind or unusual weather damage.

7.4 ACTUAL SEAMING PROCESS

- (a) The hot wedge system (i.e., the "mouse" or "hot shoe") should be properly positioned for the making of the desired single or dual (split) seam.
- (b) The principle of the hot wedge is that both surfaces to be joined come into intimate contact with the hot wedge, or anvil. The anvil slides between both layers of geomembranes and fusion is brought about by compressing the two melted surfaces together, causing an intermingling of the polymers from both sheets. The hot anvil itself melts the surface of the viscous polymer sheets and acts as a scraper/mixer, followed closely by the nip rollers which squeeze the two geomembranes intimately together, see Figure 7.6 for details.



Figure 7.5(a). Two sheets of liner being cleaned and prepared for trial seaming.



Figure 7.5(b). The two sheets being seamed together thereby forming the test strip.



Figure 7.5(c). The completed test strip being cut into individual samples for subsequent inspection and destructive testing.



Figure 7.5(d). Marking the test strip samples for identification and records.

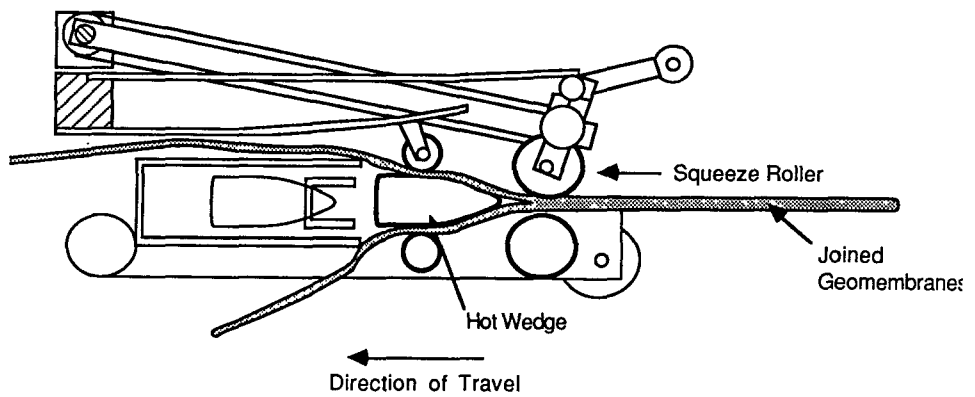
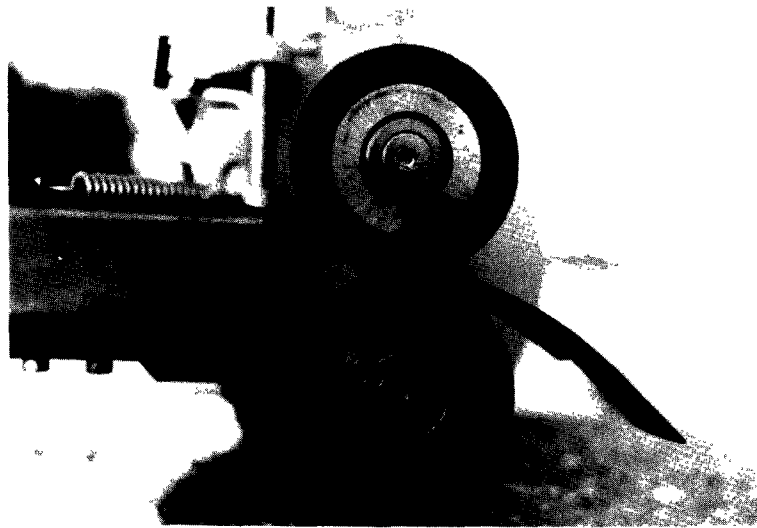

Figure 7.6. Details of the hot wedge system showing relative positions of the hot wedge, rollers and sheets to be joined.

- (c) The type of geomembrane, rate of seaming, and ambient factors such as clouds, wind, and hot sun require the temperature setting of the wedge to vary. Depending upon the records to be kept, one might record a number of different temperatures. For example, the temperature of the hot wedge, the temperature of the sheet after seaming, the temperature of the sheet away from the seaming area and the ambient temperature. This is a site specific decision usually determined by the contract specification or CQC/CQA Documents.
- (d) Power for the drive motor should be off when positioning the machine to make a seam. Manually place the machine within the overlapped sheet of material. The sheets shall be guided between the idlers and the wedge, and into the drive/nip rollers. This procedure is only possible when starting with two new sheets. When starting a weld in the middle of two sheets, the material must be loaded from the sides. The machine is to be picked up a few inches, loading the bottom sheet first, and then the top sheet. As soon as the nip rollers are engaged and the wedge is in position, the power to the drive motor should be turned on. Once the sheets are between the nip rollers, they shall be engaged immediately, otherwise a melt-through will occur within a few seconds. The hot wedge should be moved into position and locked.
- (e) It is necessary that the operator keep constant visual contact with the temperature controls, as well as the completed seam coming out of the machine. Occasional adjustments of temperature or speed as the result of changing ambient conditions will be necessary to maintain a consistent seam. Constant visual and hands on inspection is also recommended. If changes in the welding conditions are made as a response to a changing welding environment, the testing of an additional destructive sample shortly after the change is recommended.
- (f) On some soils, the device may "bulldoze" into the ground as it travels. This causes soil to enter the seam area, making the seam weak and unacceptable. To overcome this, it is recommended that the operator take some of the weight off of the front of the machine by lifting it slightly. Alternatively, some type of base for the machine to travel on should be provided. Strips of geotextile or geomembrane have proven effective to prevent this bulldozing effect. Depending on the soil conditions it may be necessary to change the size of the rollers in loose soils. It is necessary that at least two people work together in making hot wedge seams; one operator and one helper.
- (g) A fully leak-proof T-connection is necessary wherever intersecting seams are to be joined together. At such locations, the hot wedge device must be removed a short distance (approximately 15 cm or 6 inches) from the intersecting seam.

For HDPE and VLDPE this short distance must be completed by extrusion fillet seaming, see Figure 7.7. Note that the unbonded free overlaps of the sheets are to be cut away to expose the edge of the outside of the hot wedge seam. The surface must be ground to remove the surface oxide, see Section 5. The extrudate bead is then placed in a continuous fashion so as to provide complete coverage of all areas not completed by the hot wedge device.

- (h) For a leak proof T-connection in PVC, CSPE, CPE and EIA materials, the short distance referred to in (g) above must be completed by chemical bonding (fusion) or chemical adhesive.

7.5 AFTER SEAMING

- (a) A smooth insulating plate or heat insulating fabric is to be placed beneath the hot welding apparatus after usage.
- (b) For HDPE and VLDPE a slight amount of "squeeze-out" or "flashing" is a good indicator that the proper temperatures were achieved, see the sketch of Figure 7.8. It signifies a proper seam in that some of the melted polymer was laterally squeezed out of the seam zone. If an excessive amount of hot melt is being squeezed out, it is an indication of either too much heat, too much pressure, or too slow a seaming rate. Reduce the temperature and/or pressure and/or adjust the rate to correct the situation.
- (c) For VLDPE liners of 1.0 mm (40 mils) thickness a long, low wavelength pattern in the direction of the seam along its top surface is indicative of a proper weld. If the wave peaks become too close together, the machine speed should be increased until a satisfactory pattern is present. The absence of this wavelength pattern indicates that the machine speed should be decreased. There will be no wavy pattern for VLDPE liners greater than 1.0 mm (40 mils) in thickness due to the inherent stiffness of the thicker material.
- (d) Nip/drive roller marks may show on the surface when using knurled rollers. Their depth should be visually observable, but care should be taken to insure that the nip drive rollers do not create a rut, e.g. the indentation should be barely capable of being felt.
- (e) The hot wedge device has only a few adjustments that can be made, but it is very important that they be checked regularly. Cleaning of the machine should be done at least daily.
- (f) The seam must be checked visually for uniformity of width and surface continuity. Usually the installer will use a vacuum box or "air lance" depending on the geomembrane material to check for voids or gaps in the seam. For dual wedge seams the air channel can be used to evaluate seam integrity.

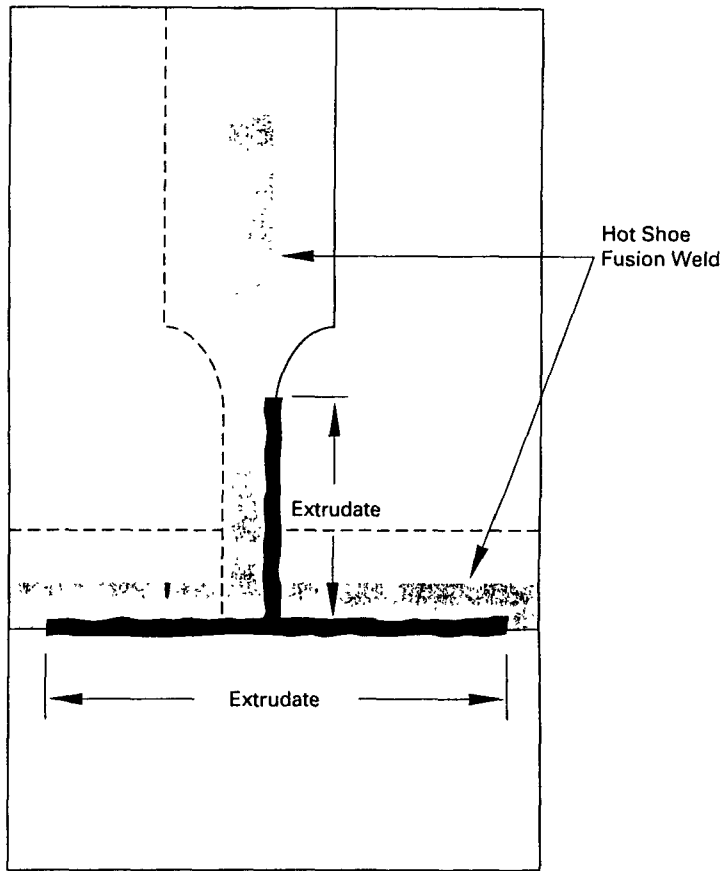

Figure 7.7. Hot wedge T-seam detail.

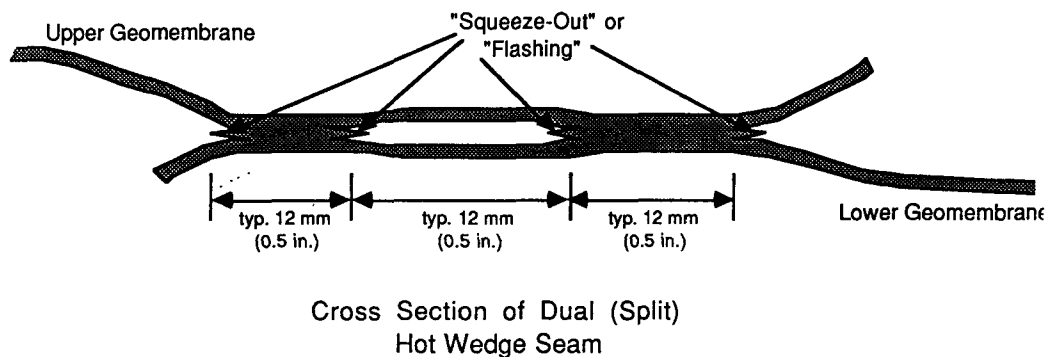

Figure 7.8. Schematic diagram of cross section of dual (split) hot wedge seam illustrating squeeze-out.

- (g) When unbonded areas are located they should be patched with at least 15 cm (6 inches) of geomembrane extending on all sides. Any area of the geomembrane where puncture holes are observed they must be patched as above with at least 15 cm (6 inches) of geomembrane extending beyond the affected areas. If grinding is to be performed to prepare the geomembrane, review instructions provided in Section 5.
- (h) Photographs of cross sections of different types of hot wedge seams follow in Figure 7.9.

7.6 UNUSUAL CONDITIONS

This section is written to give insight into conditions which go beyond the general description just presented.

- (a) High winds, or gusts of wind, are always problematic for liners. After placing the geomembrane, the panels or rolls must be adequately ballasted, e.g., with sandbags. The actual seam fabrication, however, may require the removal of some of the sandbags leaving the windward edge vulnerable to wind uplift forces. If possible, proper orientation of the overlap might be helpful. Otherwise, additional labor may be required to remove sandbags immediately in front of the seaming operation. The liner must be cleaned of any dirt and moisture left behind after sandbag removal. They are then to be replaced behind the completed seaming operation.

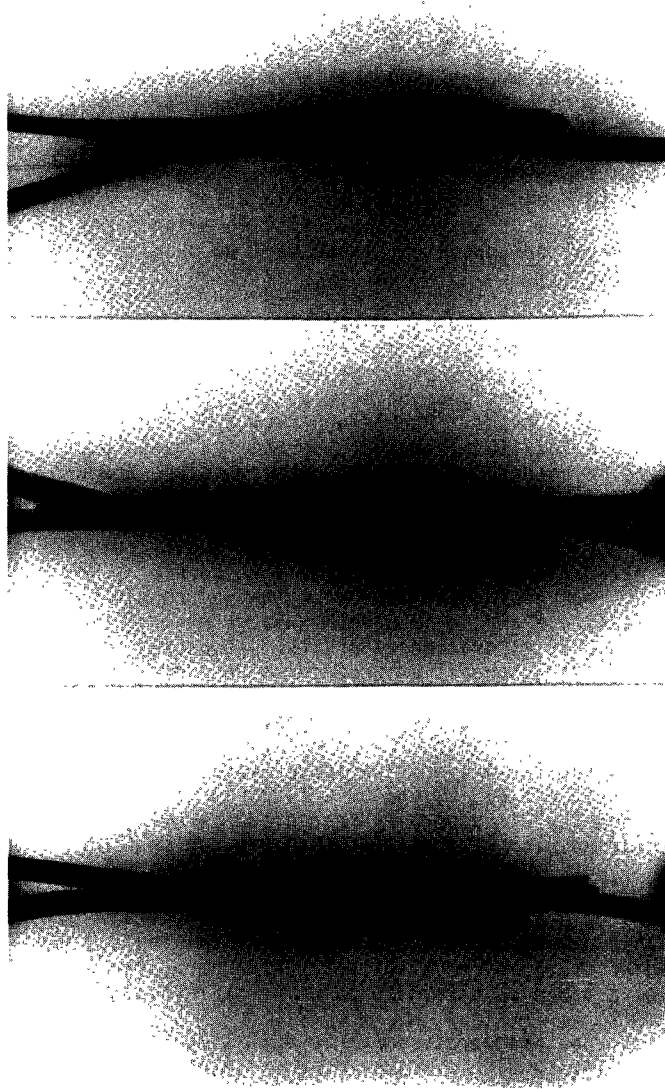

Figure 7.9. Photographs of cross sections of HDPE hot wedge seams.
Upper: Single hot wedge seam with acceptable squeeze-out
Middle: Dual hot wedge seam with excessive squeeze-out
Lower: Dual hot wedge seam with acceptable squeeze-out

- (b) Patches are necessary at locations where destructive test samples are removed or where seams are shown to fail nondestructive testing. These patches must extend a minimum of 15 cm (6 inches) beyond the outer limits of the area to be repaired. For HDPE liners the only method available is a hand held extrusion fillet procedure as described in Section 5. Particular care must be exercised when the end of the extrudate meets the beginning of the run. The double heat that the polymer will necessarily experience cannot be excessive, i.e., a large mass of extrudate should not be visible at this location. For other geomembrane types, one or more of the following methods may be used; hot air, chemical or adhesive. These will be described in subsequent sections.
- (c) Details around sumps, pipes and other appurtenances are perhaps the most demanding seams in a facility. Also due to their typical locations being at low points of the containment facility's design, these areas inherently operate under larger hydraulic heads. Should a defect from improper seaming occur in such a location leakage rates and its associated adverse impacts are heightened. Therefore, extreme care should be exercised in ensuring seam integrity in these often difficult to reach locations. For HDPE and VLDPE the extrudate should be symmetric on both liners to be joined which is difficult for external and internal edges and particularly at corners. The end of the seam run, where it joins to the beginning, should be a smooth transition and not end with a large mass of extrudate. For HDPE and VLDPE liners these details must necessarily be made by hand-held extrusion fillet procedures as described in Section 5. For PVC, CSPE, EIA and CPE type geomembranes, either hot air, chemical or adhesive methods may be used.
- (d) This section was written for material temperatures that range between 0°C (32°F) and 50°C (122°F). This is the temperature range that is generally recognized as being acceptable for seaming without taking special precautions.

For sheet temperatures below 0°C (32°F), shielding, preheating, and/or a slower seaming rate may be required. More frequent seam testing and precautions to prevent thawing subgrade (previously discussed) may have to be taken. Sharp, frozen subgrade should be avoided to eliminate point pressure damage potential.

For sheet temperatures above 50°C (122°F), shielding and rate of seaming should be adjusted. More frequent destructive seam testing may have to be taken.

FIELD NOTES:

FIELD NOTES:



SECTION 8

DETAILS OF HOT AIR SEAMS

Hot air seams represent an applicable seaming method for all geomembranes listed in Table 4.2.

8.1 GEOMEMBRANE PREPARATION

- (a) Note, that this document assumes that the proper geomembrane has been visually inspected to ensure it is free of deep scratches, or defects that would cause the sheet to not meet specifications of the installation. It is further assumed the sheet has been delivered to the site and brought to its approximate plan position for final installation and seaming. Only the material that can be seamed that day should be deployed. All deployed material should be ballasted as required to prevent wind uplift.
- (b) If the geomembrane is CPE, CPE-R, CSPE-R, EIA, EIA-R, PVC, or PVC-R and in some cases VLPDE, it will usually arrive on site in the form of fabricated panels which are accordion-folded in both directions. They are generally packaged in palletized, heavy cardboard containers. If the geomembrane is VLDPE (generally) or HDPE, it will arrive on the site in rolls.
- (c) The geomembrane should remain packaged or rolled and dry until ready for use. The material should not be unfolded or unrolled if the material temperatures are lower than -10°C (14°F) due to the possibility of cracking. If the liner is stored in a warm place, e.g. 10°C (50°F) or above, prior to being unfolded or unrolled on site, then it can be placed at -18°C (0°F) or below temperatures providing the time between removing the geomembrane from storage and deployment does not exceed one-half working day. Geomembrane deployment may be allowed under other conditions but the CQC/CQA Documents and/or project specifications must be specific as to the conditions.
- (d) The two geomembrane sheets to be joined must be properly positioned such that approximately 7.5 cm to 15.0 cm (3 to 6 inches) of overlap exists. All personnel walking on the geomembrane should have smooth soled shoes. Heavy equipment, e.g. pickups, tractors, etc. should not be allowed on the geomembrane at any time, unless otherwise specified by the manufacturer and approved in the CQC/CQA Documents.

- (e) If the overlap is insufficient and it does not fully cover the air flow nozzle, lift the sheet up to allow air beneath it and "float" it into proper position. Avoid dragging geomembrane sheets made from HDPE particularly when they are on rough soil subgrades since scratches in the material may create various stress points of different depths and orientations.
- (f) When most reinforced geomembranes are cut to accommodate odd shapes or to fit small pieces, resealing of the exposed scrim by flood coating is required by the use of manufacturer's or fabricator's approved liquid sealant.
- (g) If the overlap is excessive when placing HDPE and VLDPE and is to be removed, it should be done by trimming the lower sheet. If this is not possible and the upper sheet must be trimmed, do not use a knife with an unshielded blade to cut off the excessive amount because the blade facing downward can easily scratch or cut into the underlying geomembrane in a very vulnerable location. A shielded blade or a hook blade should be used to trim off the excess geomembrane. A photograph of such a device is shown in Figure 8.1. Whenever possible it should be used from beneath the liner in an upward cutting motion. For liners made from CPE, CPE-R, CSPE-R, EIA, EIA-R, PVC or PVC-R and VLDPE the excess material can be cut by scissors, see Figure 8.2 or can be worked away from the edges of the seam to maintain proper overlap.
- (h) All cutting and preparation of odd shaped sections or small fitted pieces should be accomplished at least 15 m (50 ft.) ahead of the seaming operation so that seaming can be completed with as few interruptions as possible.
- (i) The two opposing geomembrane sheets to be joined should visually be checked for defects of sufficient magnitude to affect seam quality. The criteria to be met and the procedures to be used in this regard should be stipulated in the contract specifications and/or in the CQC/CQA Documents.
- (j) If the construction plans require overlaps to be shingled in a particular direction this should be adhered to and verified.
- (k) Excessive undulations (waves) along the seams during the seaming operation should be avoided. When this occurs due to either the upper or lower sheet having more slack than the other or because of thermal expansion and contraction, it often leads to the undesirable formation of "fishmouths" which must be trimmed, laid flat and reseamed with a patch. An example of a fishmouth and its correction is shown in Figure 8.3(a-d).

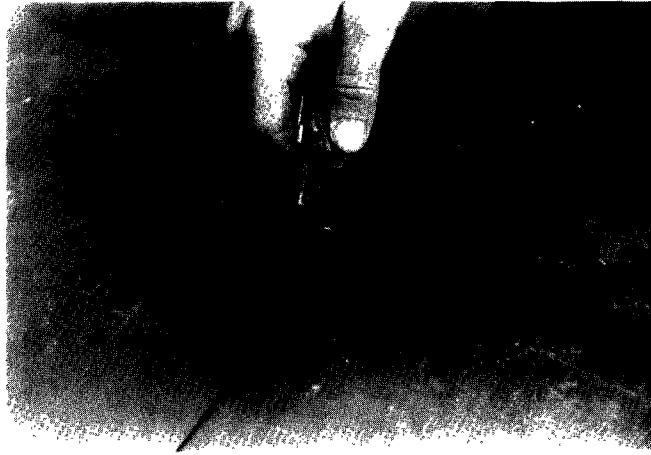

Figure 8.1. Trimming of excess geomembrane to obtain proper overlap prior to seaming.



Figure 8.2. Type of scissors recommended for cutting of geomembranes.



Figure 8.3(a). Formation of "fishmouth" with excessive slack in upper geomembrane versus lower geomembrane.



Figure 8.3(b). Cutting of "fishmouth" along its centerline.



Figure 8.3(c). Overlapping and seaming the ends of the upper geomembrane to the lower geomembrane.



Figure 8.3(d). Patch over the entire area where "fishmouth" was located.

- (l) There generally should be some slack in the installed liner which depends on the type of geomembrane, the ambient and anticipated service temperatures, length of time the geomembrane will be exposed, location of the facility, etc. This is a design consideration and the Plans and Specifications must be project specific on the amount and orientation of this slack.
- (m) The sheets which are overlapped for seaming must be clean. If dirty, they must be cleaned with dry rags and other appropriate materials.
- (n) The sheets which are overlapped for seaming must be free of moisture in the seam area.
- (o) Seaming is not allowed during rain or snow, unless proper precautions are made to allow the seam to be made with dry geomembrane sheets, e.g., within an enclosure or shelter.
- (p) It is preferable not to have water-saturated soil beneath the geomembrane during installation. Seaming boards help in this regard by lifting the seams off the soil subgrade.
- (q) If the soil beneath the geomembrane is frozen, the heat from hot air seaming devices or any preheating lamps that may be used can thaw the frost allowing water to be condensed onto the unbonded region ahead of the seam being fabricated. This possibility may be eliminated by the use of suitable seaming boards or slip sheets made from excess geomembrane material.
- (r) Ambient temperatures for seaming should be above freezing, i.e. 0°C (32°F), unless it can be proven with test strips that good seams can be fabricated at lower temperatures. However, temperature is less of a concern to good seam quality than is moisture.
- (s) For cold weather seaming, it may be advisable to preheat the sheets with a radiant heater or hot air blower, to use a tent of some sort to prevent heat losses during seaming and to make numerous test seams in order to determine appropriate seaming conditions, e.g., equipment temperatures may have to be set higher and/or seaming rates slowed down during cold weather seaming.
- (t) Sheet temperatures for seaming should be below 50°C(122°F) as measured by an infrared thermometer or surface contact thermocouple. It is recognized that depending on material type and thickness, higher temperatures may be allowed. It should also be recognized that wind and cloud cover will determine the actual sheet temperature. High temperatures affect not only worker performance but will also affect durability of some geomembranes unless special precautions, e.g. tents, etc., are taken. For temperatures above this value special attention should be paid to the seaming, frequent test strips and more diligent nondestructive testing is recommended.
NOTE: For items (q), (r), (s,) and (t) the CQC/CQA Documents and/or

project specifications and the regulatory requirements regarding hot and cold temperature seaming limitations should be reviewed to avoid possible problems with final construction certification acceptance.

8.2 EQUIPMENT PREPARATION

- (a) Properly functioning portable electric generators must be available within close proximity of the seaming region and with adequate extension cords to complete the entire seam. These generators should be of sufficient size or numbers to handle all seaming electrical requirements. The generator must have rubber tires, or be placed on a smooth plate such that it is completely stable so that it cannot damage the geomembrane or to the underlying clay liner or subgrade material. Fuel (gasoline or diesel) for the generator must be stored off the geomembrane and if accidentally spilled on the geomembrane it must be immediately removed. The area should be inspected for damage to the geomembrane and repaired if necessary.
- (b) Hot air seaming devices are of two different types: the manual, hand-held type and the automatic, machine-driven type. Photographs of each type are shown in Figure 8.4.
- (c) If a gas, other than air, is to be used, an ample supply should be available.
- (d) A manual, hand-held instrument should be checked to see that the air intakes are not obstructed and that the nozzle is of the proper type and width and that it is free from obstructions which could limit a uniform flow of air. Care should be taken in choosing the nozzle design and magnitude of the pressure. If excessive air is discharged under the top geomembrane it could create a backpressure that may blow dust or small soil particles into the seam area. The temperature should be capable of being monitored either with an instrument gage or adjustment on the device or with a separate temperature indicator. Typical temperature ranges for seaming various geomembranes are given in Table 8.1.
- (e) For the automatic, machine-driven type of hot air seaming equipment there are a number of important details. As before, the air-flow nozzle and temperature should be inspected to see that a constant flow of air at the proper temperature is being supplied. Figure 8.5 gives general details of the system showing the relative positions of the various parts.
- (f) The air-flow nozzle should be checked to see if a single track or a dual track seam is to be fabricated. If the latter, the nozzle will be subdivided at its exit end into separated air flow channels.

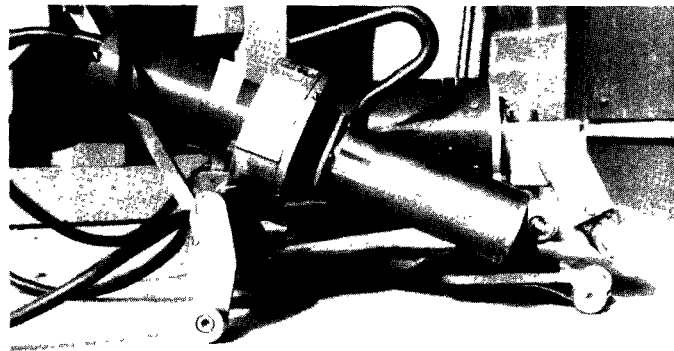
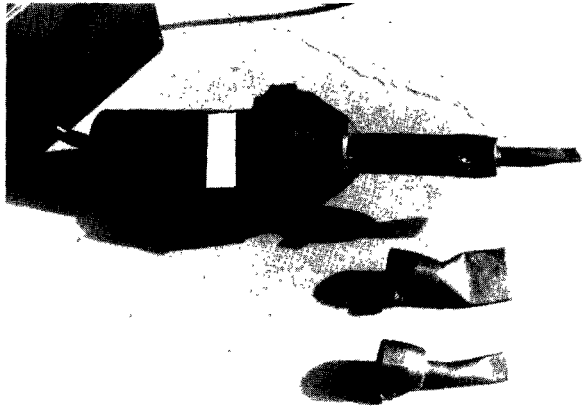

Figure 8.4. Various types of hot air seaming devices.
Upper photograph is a manual hand-held type;
Lower photograph is an automatic machine-driven type.

TABLE 8.1. TYPICAL TEMPERATURE RANGES FOR HOT AIR SEAMING OF GEOMEMBRANES (I.E., AS THE AIR EXITS THE CHAMBER).

Geomembrane Type	Minimum* °C (°F)	Maximum** °C (°F)
CPE	245 (475)	650 (1200)
CPE-R	245 (475)	650 (1200)
CSPE-R	245 (475)	650 (1200)
EIA	370 (700)	650 (1200)
EIA-R	370 (700)	650 (1200)
HDPE***	400 (750)	650 (1200)
PVC	370 (700)	650 (1200)
PVC-R	370 (700)	650 (1200)
VLDPE***	350 (660)	650 (1200)

* For dry, warm weather seaming conditions

** For damp, cold weather seaming conditions

*** For textured or roughened HDPE or VLDPE sheet increase temperatures about 40°C (72°F). Also, slower seaming rates and higher pressures may be required.

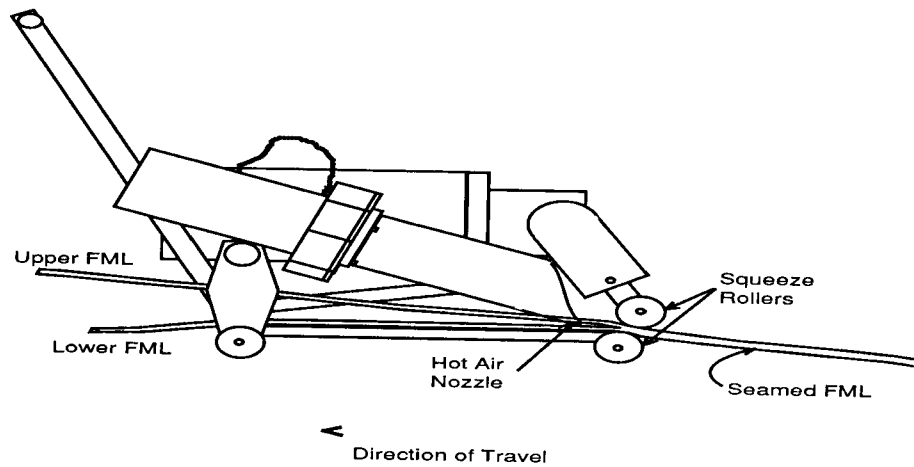

Figure 8.5. Cross section of automated machine-driven hot air seaming device for geomembranes.

- (g) Knurled rollers are used for applying pressure on the sheets and driving the device. They immediately follow the air nozzle. The knurled rollers should be inspected to ensure there are no sharp surfaces and that wheels are smoothly beveled on the edges.
- (h) If a chain drive powers the device and applies pressure to the nip/drive rollers it should be inspected for synchronization of travel, proper functioning and fit. Loose chains or damaged sprockets should be repaired or replaced.
- (i) As the geomembrane sheet materials pass through the machine, they should come in contact with air from the full width of the air nozzle in order to heat the material properly and uniformly. On some devices idler rollers on both sides of the device are adjustable and must make the material conform as it passes through the machine.
- (j) The front part of the seaming device should be inspected for sharp corners and irregular details which may damage the geomembrane or cause sheet hang-up.

- (k) If available, temperature controllers on the device should be set according to type of geomembrane, the thickness, the ambient temperature, and the rate of seaming. Table 8.1 gives typical values but this is a site and material specific decision usually determined by the contract specification or CQC/CQA Documentation.
- (l) If available, the force sensors at the nip rollers should be checked for accuracy and repeatability.

8.3 TEST STRIPS

A general requirement of most CQA Documents is that "test seams" or "test strips" be made on a periodic basis. Test strips generally reflect the quality of field seams but should never be used solely for final field seam acceptance. Final field seam acceptance should be specified in the contract specification and should include a minimum level of destructive testing of the production field seams. Test strips are made to minimize the amount of destructive sampling/testing which requires subsequent repair of the final field seam. Typically these test seams, for each seaming crew, are made about every four hours, or every time equipment is changed, or if significant changes in geomembrane temperature are observed, or as required in the contract specification. This is a recommended practice that should be followed when seaming all types of geomembranes. The purpose of these tests is to establish that proper seaming materials, temperatures, pressures, rates, and techniques along with the necessary geomembrane pre-seaming preparation is being accomplished. Test strips may be used for CQA/CQC evaluation, archiving, for exposure tests, etc., and must be of sufficient length to satisfy these various needs.

Each seaming crew and the materials they are using must be traceable and identifiable to their test seams. While the test seams are being prepared, cured, and CQC tested, the seaming crew may continue to work as long as the seams they have made (and are making) since their last acceptable test sample strip was prepared, are completely traceable and identifiable. If a test seam fails to meet the field seam design specification, then an additional test seam sample will have to be made by the same seaming crew - using the same tools, equipment and seaming materials - and retested.

The liner's finished field seams will not be accepted unless the before and after "test seam sample strip" CQC test results (or other CQC seam test result criteria as required per the design specification) are acceptable per the site's design specifications. If a seam is not accepted, destructive testing of samples from the actual seam will be removed from the liner and tested. If the actual seam destructive test results still do not meet the design specification requirement, then the unacceptable seams will all have to be repaired or reconstructed with seaming materials by a test proven seaming crew that has passed its testing requirements. The procedure illustrated in the flow chart of Figure 8.6 must be followed. Note that the failure of test strip 1 requires two actions: (a) the making of test strip 2, and (b) an increased frequency of destructive tests on production field seams made during the curing of test strip 1 (if any were made). This

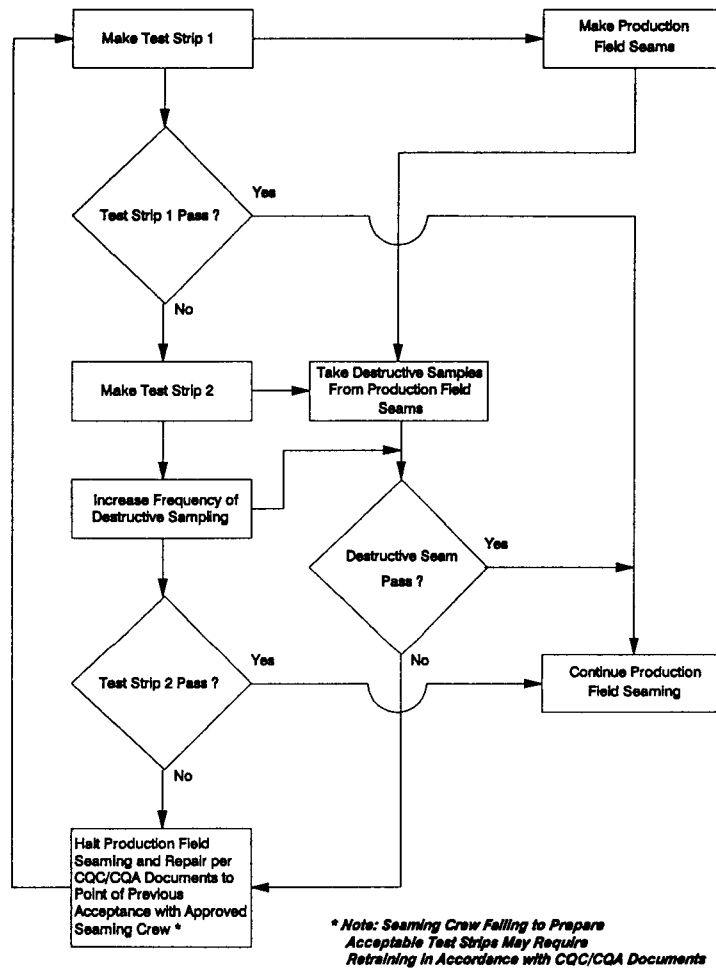

Figure 8.6. Test strip process flow chart.

increased frequency must be stipulated in the contract specifications or in the CQC/CQA Documents.

If the destructive seams fail or if test strip 2 fails, production field seaming is halted. All production field seams made during the interval are repaired per the contract specifications or CQC/CQA Documents to the point of previous acceptance with an approved seaming crew.

At this point, the seaming crew that failed to pass both strip tests must adjust and recertify current seaming equipment and technique or obtain new seaming equipment, tools and/or retrain personnel and begin making initial test strip samples.

For hot air seams, test strips of the type shown in Figure 8.7(a-d) are prepared. The seam is centered lengthwise between the two sheets to be joined. Figure 8.7(a) shows the geomembrane to be seamed being cut and prepared for seaming, 8.7(b) shows the actual test strip being seamed, 8.7(c) shows the sampling of the test strip for subsequent destructive testing, and 8.7(d) shows the individual samples cut from the test strip being identified. For geomembranes that are seamed by thermal methods, the seams can be tested after they are allowed to cool in ambient air at least 5-10 minutes or longer prior to shear and peel testing.

As previously stated, all seam test samples must be prepared in triplicate sets preferable in a continuous seam which can be cut in thirds; one set for CQC tests, one set for CQA tests and one set made available to (or retained for) the agency/owner/design organization. If referee test results are required, CQA test results from destructive testing of actual seam samples will prevail.

During the CQC and CQA test requirement periods, a liner should not be covered and it cannot be placed into service. This will insure the ease and viability of repairing or reconstructing in the event it is required. During this period it is imperative that the liner be properly ballasted and otherwise secured so as to prevent wind or unusual weather damage.

8.4 ACTUAL SEAMING PROCESS FOR THE MANUAL, HAND-HELD TYPE OF HOT AIR SEAMING

- (a) The hot air system should be properly positioned for the making of the desired seam, see Figure 8.8. Note the position of the hand-held roller immediately behind the gun.
- (b) The principle of the technique is that the hot air is to melt the surface of both the lower and the upper geomembrane followed immediately by roller pressure to intimately join the melted viscous surfaces of the materials. Uniformity of melting across the entire surface to be joined is an important detail. Excessive



Figure 8.7(a). Geomembrane being cut and prepared for trial seaming.

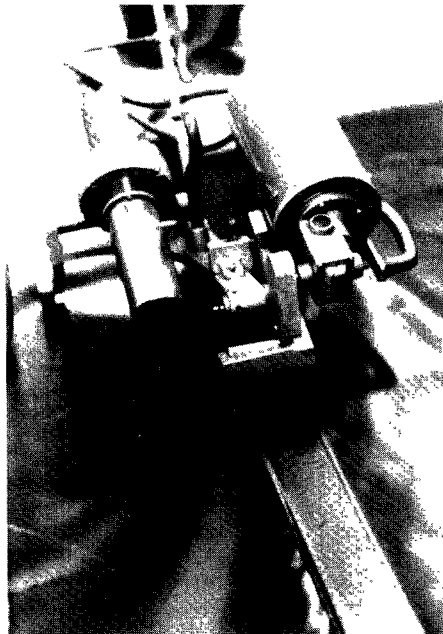

Figure 8.7(b). The two sheets being seamed together thereby forming the test strip.



Figure 8.7(c). The completed test strip being cut into individual samples for subsequent inspection and destructive testing.

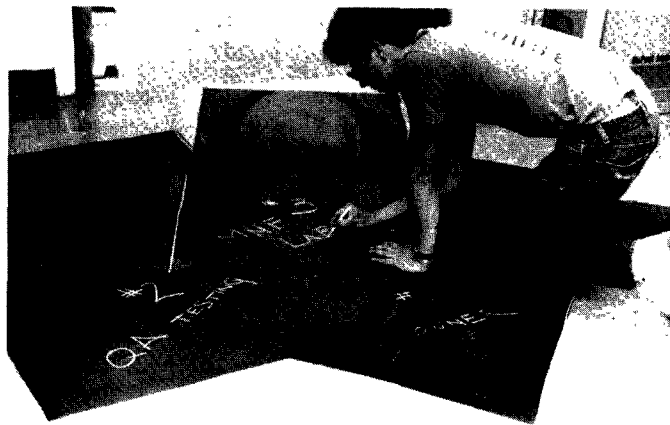

Figure 8.7(d). Marking the test strip samples for identification and records.



Figure 8.8. Fabrication of a field seam using manual hand-held hot air seaming technique.

melting as well as inadequate melting must be avoided. Note that the roller pressure is exerted manually.

- (c) Temperature and dwell time will vary according to the geomembrane type, thickness and the ambient temperature. These variables, in turn, will dictate the rate of seaming.
- (d) Other ambient factors such as sun, clouds, wind and humidity will require alterations to the seaming rate. This is a site specific consideration.
- (e) It is necessary that the seamer(s) keep constant visual contact with the completed seam.
- (f) It is sometimes advantageous to have two man work crews; one with the hot air gun, the other with the roller. The second person is then somewhat free to do visual and hands on inspection.
- (g) Excessive surface deformation indicating too much heat, or too slow of a travel rate, are obviously not permitted.

8.5 ACTUAL SEAMING PROCESS FOR THE AUTOMATED, MACHINE-DRIVEN TYPE OF HOT AIR SEAMING

- (a) The hot air equipment should be properly positioned for the making of the desired single or dual (split) seam, see Figure 8.9(a-b).
- (b) As mentioned previously, the principle of the hot air seaming technique is that both surfaces to be joined come into intimate contact with one another after reaching the proper temperature. Contact is automatically controlled via the rollers which create pressure such that intermingling of the material from both sheets occurs.
- (c) Typical temperature settings will vary according to the type and thickness of geomembrane being installed, the ambient temperature and the rate of travel. The CQC/CQA Documentation should be reviewed for appropriate temperature ranges.
- (d) Ambient factors such as sun, clouds, wind, and humidity will require the seaming rate to vary. This is a site specific condition.
- (e) Power for the drive motor should be off when positioning the machine to make a seam. Manually place the machine within the overlapped sheets of material. The sheets shall be guided beneath and above the air nozzle, and into the drive/nip rollers. This procedure is only possible when starting with two new sheets. When restarting a partially completed run in the middle of two sheets, the material must be loaded from the sides. The machine is to be picked up a few inches, loading the bottom sheet first, and then the top sheet. As soon as the nip rollers are engaged, the hot air should be supplied to the sheets and the power to the drive motor should be turned on.
- (f) It is necessary that the operator keep constant visual contact with the completed seam coming out of the machine. Occasional adjustments of temperature or speed will be necessary to maintain a consistent seam weld.
- (g) On some soils, the machine may "bulldoze" into the ground as it travels. This causes soil to enter the area to be seamed, making the seam weak and unacceptable. To overcome this, it is recommended that the operator take some of the weight off the back of the machine by lifting it slightly. Alternatively, some type of base for the machine to travel on could be provided. Strips of geotextile or geomembrane have proven effective to prevent this bulldozing effect. It might be required to change the size of the rollers. It is recommended that at least two people work together in making hot air seams; one operator and one helper.

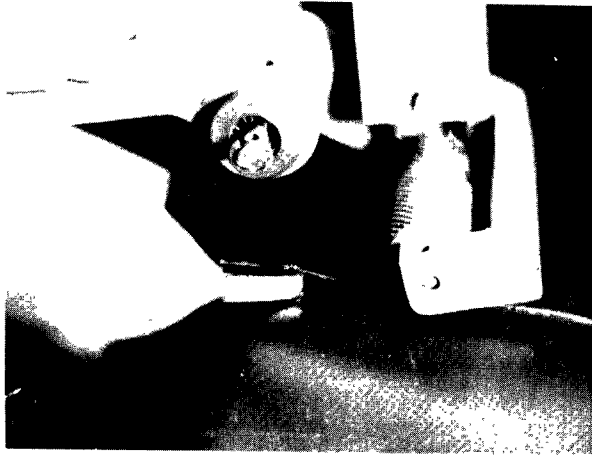

Figure 8.9(a). Fabrication of a field seam using automated, machine driven hot air seaming technique (side view).

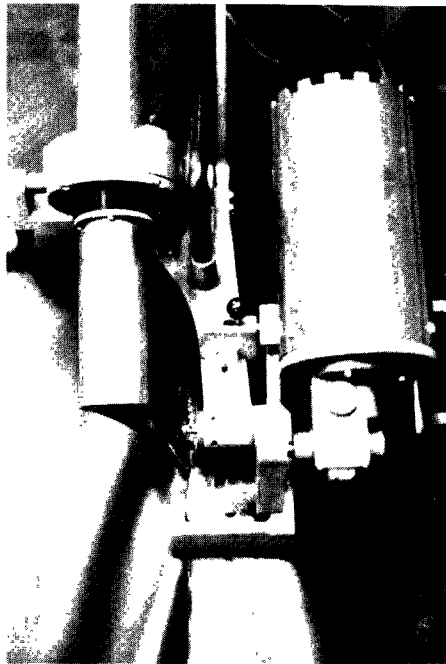

Figure 8.9(b). Fabrication of a field seam using automated, machine driven hot air seaming technique (top view).

- (h) A leak-proof T-connection is necessary wherever intersecting seams are to be joined together. At such locations when HDPE or VLDPE geomembrane is used, the hot air device must be removed a short distance (approximately 15 cm or 6 inches) from the intersecting seam. This short distance must be completed by hand held hot air seaming, or by extrusion fillet seaming, see Figure 8.10. Note that the unbonded free overlaps of the sheets are to be cut away to expose the edge of the outside of the hot air seam. The extrudate bead is then placed in a continuous fashion so as to provide complete coverage of all areas not completed by the hot air device.
- (i) For leak proof T-connections in PVC, CSPE, CPE and EIA materials, the short distance referred to in (h) above must be completed by chemical bonding (fusion) or chemical adhesive.

8.6 AFTER SEAMING

- (a) A smooth insulating plate or heat insulating fabric is to be placed beneath the hot seaming apparatus after usage to avoid damage to the geomembrane.
- (b) A slight amount of "squeeze-out" or "flashing" is a good indicator that the proper temperatures were achieved, see the sketches of Figure 8.11. It signifies a proper seam in that some of the melted polymer was laterally squeezed out of the seam zone. If an excessive amount of hot melt is being squeezed out, it is an indication of either too much heat, too much pressure, or too slow a seaming rate. Reduce the temperature and/or pressure and/or adjust the rate to correct the situation.
- (c) For VLDPE liners of 1.0 mm (40 mils) thickness, a long, low wavelength pattern in the direction of the seam along its top surface is indicative of a proper weld. If the wave peaks become too close together, the machine speed should be increased until a satisfactory pattern is present. The absence of this wavelength pattern indicates that the speed should be decreased. There will be no wavy pattern for VLDPE liners greater than 1.0 mm (40 mils) in thickness due to the inherent stiffness of the thicker material.
- (d) Nip/drive roller marks may show on the surface when using knurled rollers. Their depth should be visually observable, but care should be taken to insure that the nip drive rollers do not create a rut, e.g. the indentation should be barely capable of being felt.
- (e) The hot air seaming device has only a few adjustments that can be made, but it is very important that they be checked regularly. Cleaning of machine should be done at least daily.

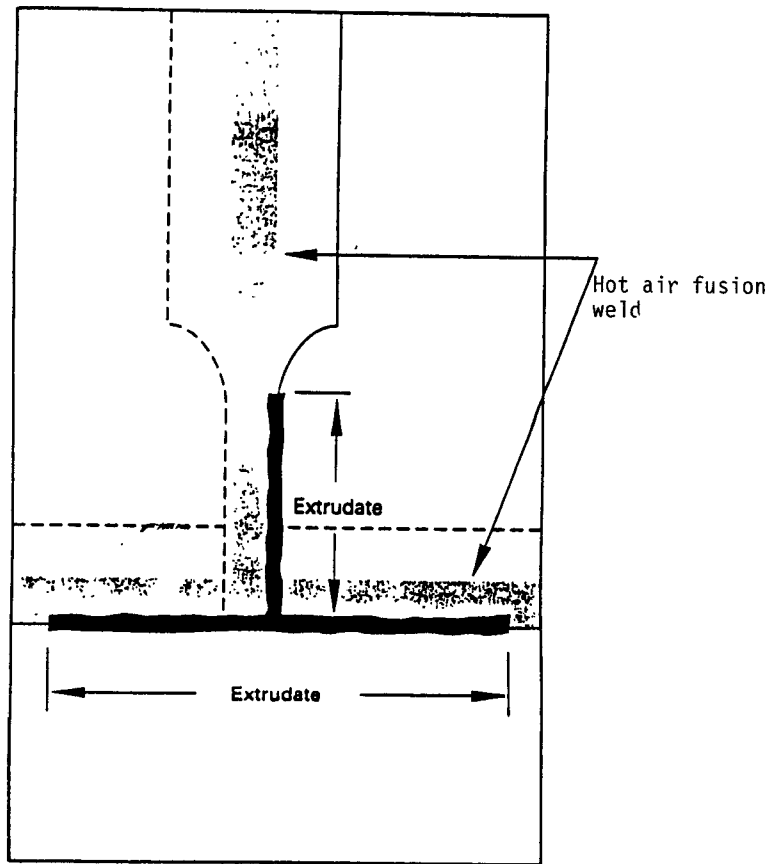

Figure 8.10. Dual track hot air machine T-seam detail for HDPE or VLDPE.

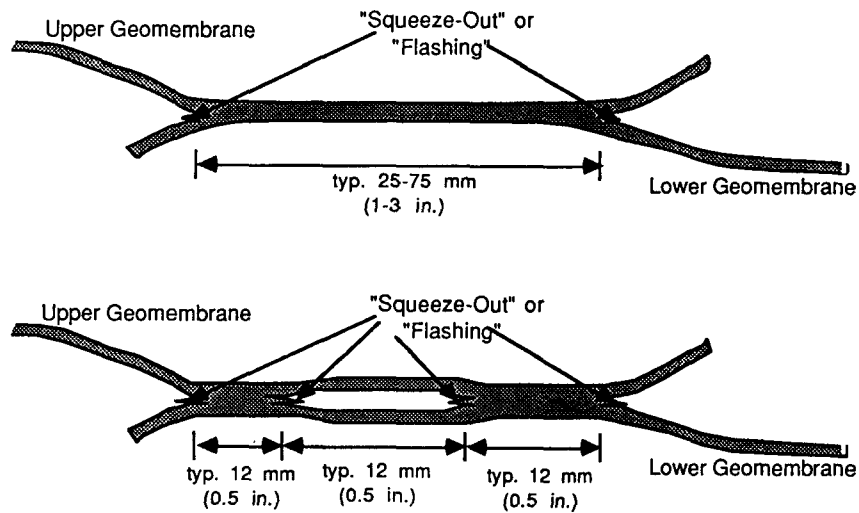

Figure 8.11. Schematic diagrams of cross sections of single and dual (spilt) hot air seams illustrating squeeze-out.

- (f) The seam must be checked visually for uniformity of width and surface continuity. Usually the installer will use a vacuum box or air lance to check for voids or gaps in the seam.
- (g) When unbonded areas are located, they should be patched with at least 15 cm (6 inches) of geomembrane extending on all sides. Any area of the geomembrane where puncture holes are observed must be patched as above with at least 15 cm (6 inches) of geomembrane extending beyond the affected areas.
- (h) Photographs of cross sections of hot air seams follow in Figure 8.12.

8.7 UNUSUAL CONDITIONS

This section is written to give insight into conditions which go beyond the general description just presented.

- (a) High winds, or gusts of wind, are always problematic for liners. After placing the geomembrane, the panels or rolls must be adequately ballasted, e.g., with sandbags. The actual seam fabrication, however, may require the removal of some of the sandbags leaving the windward edge vulnerable to wind uplift forces.

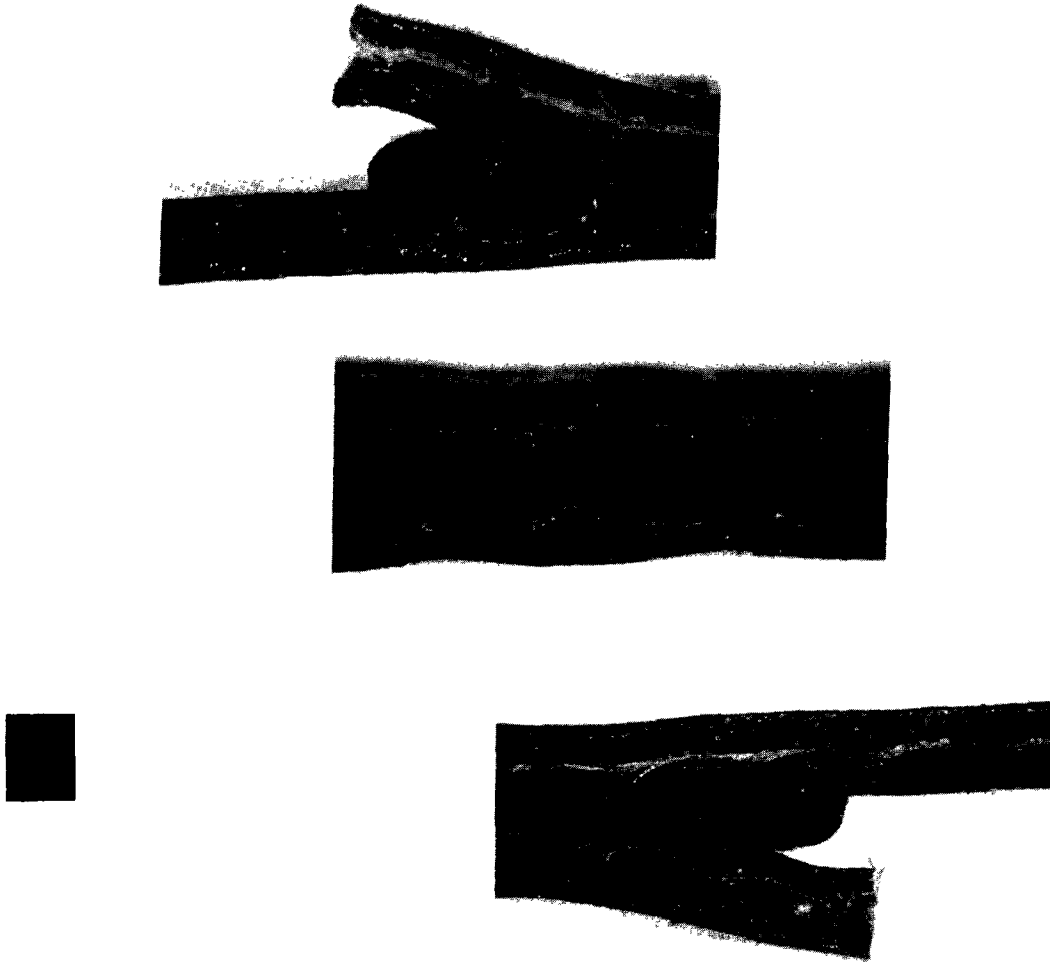

Figure 8.12. Cross sections of EIA-R liner (single track) seams fabricated by the hot air method showing left, center, and right sides of completed seam (light colored lines are the reinforcing fabric yarns).

If possible, proper orientation of the overlap might be helpful. Otherwise, additional labor may be required to remove sandbags immediately in front of the seaming operation. The liner must be cleaned of any dirt and moisture left behind after sandbag removal. They are then to be replaced behind the completed seaming operation.

- (b) Patches are necessary at locations where destructive test samples are removed or where seams are shown to fail nondestructive testing. These patches must extend a minimum of 15 cm (6 inches) beyond the outer limits of the area to be repaired. For HDPE and VLDPE liners, another method available is the hand-held extrusion fillet procedure described in Section 5. Particular care must be exercised when the end of the run meets the beginning of the run. The double heat that the polymer will necessarily experience cannot be excessive. For other geomembrane types, one or more of the following methods may be used; hot air, chemical or adhesive methods be used. These will be described in subsequent sections.
- (c) Details around sumps, pipes and other appurtenances are perhaps the most demanding locations to properly seam in an entire facility. Also due to their typical locations being at low points of the containment facility's design, these areas inherently operate under larger hydraulic heads. Should a defect from improper seaming occur in such a location leakage rates and its associated adverse impacts are heightened. Therefore, extreme care should be exercised in ensuring seam integrity in these often difficult to reach locations. For HDPE and VLDPE liners these details must necessarily be made by hand held hot air or extrusion fillet procedures. For PVC, CSPE, CPE and EIA either hot air or chemical fusion procedures can be used.
- (d) This section was written for material temperatures that range between 0°C (32°F) and 50°C (122°F). This is the temperature range that is general recognized as being acceptable for seaming without taking special precautions.

For sheets below 0°C (32°F), shielding, pre-heating, and/or a slower seaming rate may be required. More frequent seam testing and precautions to prevent thawing subgrade (previously discussed) may have to be taken. Sharp, frozen subgrade should be avoided to eliminate point pressure damage potential.

For sheet temperatures above 50°C (122°F), shielding and rate of seaming should be adjusted. More frequent destructive seam testing may have to be taken.

FIELD NOTES:



SECTION 9

DETAILS OF CHEMICAL AND BODIED CHEMICALLY-FUSED SEAMS

As is shown in Table 4.2, chemically-fused seams are an applicable field seaming method for PVC, CPE, CSPE, and EIA liners, both reinforced and unreinforced. Fusion chemicals may be either bodied (thickened) or nonbodied. The application and seaming procedure for the use of either one is basically the same. Bodied fusion chemicals are thickened with materials that are also common to the geomembrane itself. They may be used interchangeably with non-bodied fusion chemicals; however, they are more commonly used to increase the dwell or working time, seal exposed fabric or scrim edges or on slopes to prevent rapid run-off of the seaming chemical. This section focuses on the use of both forms of fusion chemicals as though they were a single entity for field seaming compounded thermoplastic and thermoplastic elastomeric geomembranes.

9.1 GEOMEMBRANE PREPARATION

- (a) Note that this document assumes that the geomembrane has been visually inspected to ensure it is free of deep scratches or defects that would cause the sheet to not meet the specifications of the installation. It is further assumed the sheet has been delivered to the site and brought to its approximate plan position (as per the design panel layout) for final installation and seaming. Only the material that can be seamed that day should be deployed. All deployed material should be ballasted as required to prevent wind uplift.
- (b) The geomembrane will usually arrive on site in the form of prefabricated panels which are accordion folded in both directions. These panels are usually packaged in palletized, heavy weatherable cardboard containers.
- (c) The geomembrane should remain packaged and dry until ready for use. The material should not be unfolded when material temperatures are lower than -10°C (14°F) due to the possibility of cracking. If the panel is stored in a warm place, e.g. 10°C (50°F) or above, prior to being unfolded on site, then it can be placed at -18°C (0°F) or below temperatures, providing the time between removing the geomembrane from storage and deployment does not exceed one-half working day. Geomembrane deployment may be allowed for other conditions but the CQC/CQA Documents and/or project specifications must be specific as to the conditions.

- (d) All personnel walking on the geomembrane liner should have smooth-soled shoes. Heavy equipment, e.g. pickups, tractors, etc., should not be allowed on the geomembrane unless otherwise specified by the manufacturer and approved in the CQA/CQC Documents.
- (e) The two geomembrane sheets to be joined must be properly positioned so that approximately 15 cm (6 inches) of overlap exists. If the overlap is insufficient, lift the geomembrane sheet up and down to allow air to be pumped beneath it and "float" it into proper position.
- (f) If the overlap is excessive, the excess material may be trimmed with scissors or worked away from the edges of the seam to maintain proper overlap, as shown in Figure 9.1(a-b). All cut scrim edges must be sealed with a flood coat of bodied chemical or the manufacturer's/fabricator's approved liquid sealant.
- (g) When reinforced geomembranes are cut to accommodate odd shapes or to fit small pieces, resealing of the exposed scrim by flood coating is required by the use of manufacturer's or fabricator's approved liquid sealant. This sealant is usually a thickened chemical of the same type used to do the production field seaming.
- (h) All cutting and preparation of odd shaped sections or small fitted pieces can be accomplished at the discretion of the installer so that production field seaming can be completed with as few interruptions as possible.
- (i) The two opposing geomembrane sheets to be joined should be visually checked for defects of sufficient magnitude to effect seam quality. The criteria to be met and the procedures to be used in this regard should be stipulated in the contract specifications and/or in the CQC/CQA Documents.
- (j) If the construction plans require overlaps to be shingled in a particular direction, this should be checked.
- (k) Excessive undulations (waves) along the seams during the seaming operation should be avoided. When this occurs due to either the upper or lower sheet having more slack than the other or because of thermal expansion and contraction, it often leads to the undesirable formation of "fishmouths" which must be trimmed, laid flat and reseamed with a patch. An example of a fishmouth and its correction is shown in Figure 9.2(a-c).
- (l) There should be some slack in the installed liner which depends on the type of geomembrane, the ambient and anticipated service temperatures, length of time the geomembrane will be exposed, location of the facility, etc. This is a design consideration and the plans and specifications must be project specific on the amount and orientation of this slack.



Figure 9.1(a). Trimming of excess geomembrane to obtain proper overlap prior to seaming.



Figure 9.1(b). Type of scissors recommended for cutting of geomembranes.

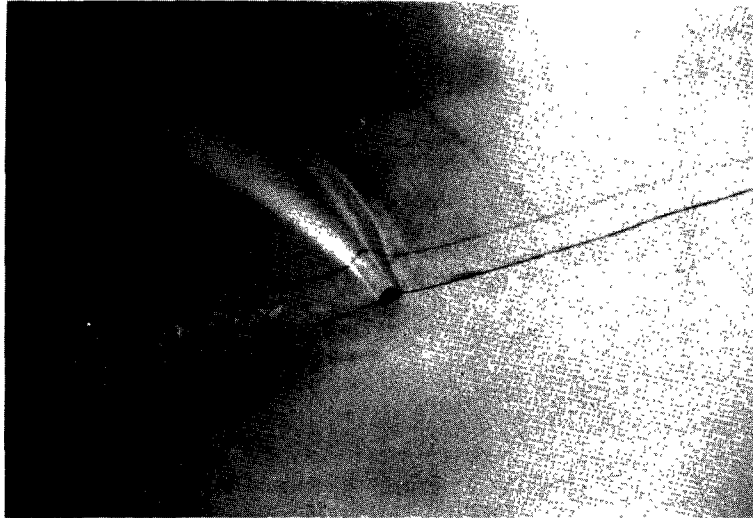

Figure 9.2(a). Formation of "fishmouth" resulting from excessive slack in upper geomembrane versus lower geomembrane.

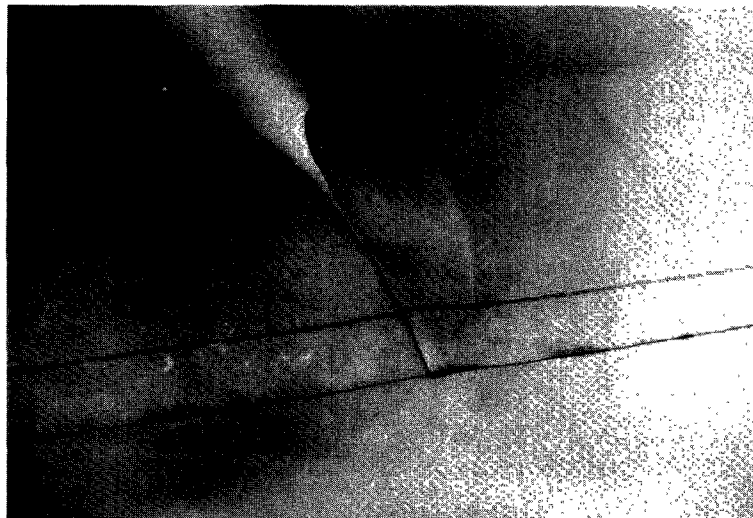

Figure 9.2(b). Cutting of "fishmouth" along its centerline.



Figure 9.2(c). Patch over the entire area where "Fishmouth" was located.

- (m) The sheets which are overlapped for seaming must be clean. If dirty, they must be cleaned with dry rags. If processing aids were used in the manufacture of the sheet, this must be removed.
- (n) The sheets which are overlapped for seaming must be free of moisture in the seam area.
- (o) Seaming is not allowed during rain or snow, unless proper precautions are made to allow the seam to be made with dry geomembrane sheets, e.g., within an enclosure or shelter.
- (p) It is preferable not to have water saturated soil beneath the geomembrane during installation. Seaming boards help in this regard by lifting the seams off the soil subgrade.
- (q) If the soil beneath the geomembrane is frozen, the heat from hot air guns or any preheating lamps that may be used can thaw the frost allowing water to be condensed onto the unbonded region ahead of the seam being fabricated. This possibility may be eliminated by the use of suitable seaming boards or slip sheets made from excess geomembrane.
- (r) Sheet temperatures for seaming should be above freezing, i.e. 0°C (32°F) unless it can be proven with test strips that good seams can be fabricated at lower temperatures. However, temperature is of less concern to good seam quality than is moisture.

- (s) For cold weather seaming, it may be advisable to preheat the sheets with a radiant heater, or hot air blower, or to use a tent of some sort to prevent heat losses during seaming and to make numerous test seams in order to determine appropriate seaming conditions.
- (t) Sheet temperatures for seaming should be below 50°C (122°F) as measured by an infrared thermometer or a surface contact thermocouple. It is recognized that depending on material type and thickness, higher temperatures may be allowed. It should also be recognized that wind and cloud cover will determine the actual sheet temperature. High temperatures affect not only worker performance, but may also affect seam durability of some geomembranes unless special precautions are taken. For temperatures above this value special attention should be paid to the seaming, frequent test strips and more diligent non destructive testing is recommended. **NOTE:** For items (q), (r), (s,) and (t) the CQC/CQA Documents and/or project specifications and the regulatory requirements regarding hot and cold temperature seaming limitations should be reviewed to avoid possible problems with final construction certification acceptance.

9.2 EQUIPMENT PREPARATION

- (a) An ample supply of the appropriate fusion chemicals must be available at the job site. They should be stored at room temperature and sheltered from the elements. Storage is to be away from any portion of the geomembrane so that accidental spillage can not occur on the liner itself, or over a diked retaining pad or impoundment, so that chemicals cannot penetrate the ground. The listed shelf life of the fusion chemical shall not be exceeded. Fusion chemicals that have been left open and started to solidify should not be remixed or used.
- (b) An ample supply of plastic applicator bottles (or other suitable applicators) with special end applicators should be available. Note that the filling of these applicator bottles is to take place away from the geomembrane area. See Figure 9.3 for the typical type of applicator bottles and their use in applying the fusion chemicals.
- (c) A 5 cm to 10 cm (2 to 4 inches) wide paint brush may be used to apply bodied chemical to the area to be seamed. The bristles should be made from materials which do not react with the chemical being applied.
- (d) Clean, dry rags and or sponges will be needed to clean the sheet areas to be seamed as well as to wipe away excess chemical from the seamed area after the seam is completed. These rags should be chemically resistant to the bonding liquid. Lint-free natural fiber rags made of cotton or wool are generally recommended.

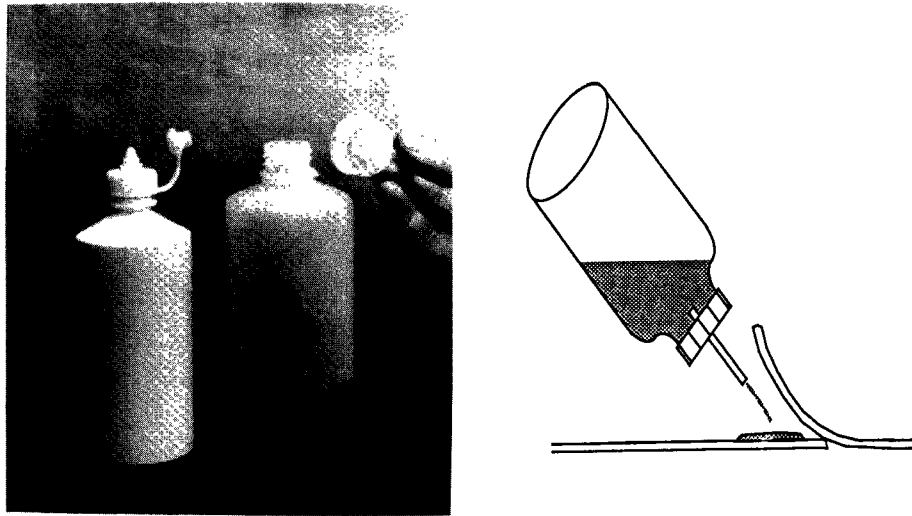

Figure 9.3. Photograph of applicator bottles and method of application.

- (e) Pressure applicators including rollers, either steel, rubber, nylon or wood depending on site specific conditions, from 5 to 9 cm (2 to 3 1/2 inches) wide, will be needed for applying pressure to the bonded area after the fusion chemical has been applied. Figure 9.4 illustrates the types of rollers in common use. Pressure applied with a rag or wood paddle has been successfully used in place of a roller to achieve a good seam.
- (f) Seaming boards or slip sheets should be available. They need to be rigid enough to provide adequate resistive force for seaming pressures. The seaming boards must be smooth with rounded corners and edges and have a hole drilled at one end for attaching a pull rope. If needed, they may serve as temporary working platforms placed beneath the seaming area to provide a smooth surface and a base for physical resistance to the applied pressure of the rollers. They also provide insulation to heat and help keep dirt and moisture away from the seaming area.
- (g) Hot air guns or other appropriate heating devices are necessary to heat the geomembrane when performing cold-temperature field seaming.
- (h) For cold-temperature seaming, properly functioning electric generators to power the heating devices or heat guns, must be available within close proximity of the seaming region and with adequate extension cords to complete the entire seam. These generators should be of sufficient size or numbers to handle all seaming and preheating electrical requirements. The generator must have rubber tires, or be placed on a smooth plate such that it is



Figure 9.4. Photograph of types of rollers used to apply pressure to chemically bonded seams.

completely stable in order that it will not damage the geomembrane. Fuel (gasoline or diesel) for the generator must be stored away from the geomembrane and if accidentally spilled on the geomembrane must be immediately removed. The area should be inspected for damage to the geomembrane and repaired if necessary.

9.3 TEST STRIPS

A general requirement of most CQA Documents is that "test seams" or "test strips" be made on a periodic basis. Test strips generally reflect the quality of field seams but should never be used solely for final field seam acceptance. Final field seam acceptance should be specified in the contract specification and should include a minimum level of destructive testing of the production field seams. Test strips are made to minimize the amount of destructive sampling/testing which requires subsequent repair of the final field seam. Typically these test seams, for each seaming crew, are made about every four hours, or every time equipment is changed, or if significant changes in geomembrane temperature are observed, or as required in the contract specification. This is a recommended practice that should be followed when seaming all types of geomembranes. The purpose of these tests is to establish that proper seaming materials, temperatures, pressures, rates, and techniques along with the necessary geomembrane pre-seaming preparation is being accomplished. Test strips may be used for CQA/CQC evaluation, archiving, for exposure tests, etc., and must be of sufficient length to satisfy these various needs.

Each seaming crew and the materials they are using must be traceable and identifiable to their test seams. While the test seams are being prepared, cured, and CQC tested, the seaming crew may continue to work as long as the seams they have made (and are making) since their last acceptable test sample strip was prepared, are completely traceable and identifiable. If a test seam fails to meet the field seam design specification, then an additional test seam sample will have to be made by the same seaming crew - using the same tools, equipment and seaming materials - and retested.

The liner's finished field seams will not be accepted unless the before and after "test seam sample strip" CQC test results (or other CQC seam test result criteria as required per the design specification) are acceptable per the site's design specifications. If a seam is not accepted, destructive testing of samples from the actual seam will be removed from the liner and tested. If the actual seam destructive test results still do not meet the design specification requirement, then the unacceptable seams will all have to be repaired or reconstructed with seaming materials by a test proven seaming crew that has passed its testing requirements. The procedure illustrated in the flow chart of Figure 9.5 must be followed. Note that the failure of test strip 1 requires two actions: (a) the making of test strip 2, and (b) an increased frequency of destructive tests on production field seams made during the curing of test strip 1 (if any were made). This increased frequency must be stipulated in the contract specifications or in the CQC/CQA Documents.

If the destructive seams fail or if test strip 2 fails, production field seaming is halted. All production field seams made during the interval are repaired per the contract specifications or CQC/CQA Documents to the point of previous acceptance with an approved seaming crew.

At this point, the seaming crew that failed to pass both strip tests must adjust and recertify current seaming equipment and technique or obtain new seaming equipment, tools and/or retrain personnel and begin making initial test strip samples.

For chemical fusion seams or bodied chemical fusion seams, test strips of the type shown in Figure 9.6(a-d) are prepared as required by the contract specification or CQC/CQA Documents. The seam is centered lengthwise between the two sheets to be joined. Figure 9.6(a) shows the two geomembrane pieces to be seamed being cleaned and properly aligned, 9.6(b) shows the chemical being applied to bonding area, 9.6(c) shows the completed seam being smoothed and rolled, 9.6(d) shows samples being cut from completed test strips for subsequent destructive testing.

For geomembranes that are seamed by chemical fusion methods, on site CQC testing requires time that, without accelerated curing, can range from a few hours to days. Accelerated curing of seam test samples using an oven on site, or another suitable heat source, can be accomplished at temperature ranges between 50°C (122°F) and 70°C (158°F) within periods that range from 1 hour to 16 hours, dependent upon the following variables: material type, thickness, chemical fusion system, seam width, etc. After the accelerated curing period the samples are allowed to cool at least 1/2 hour prior to CQC peel and shear

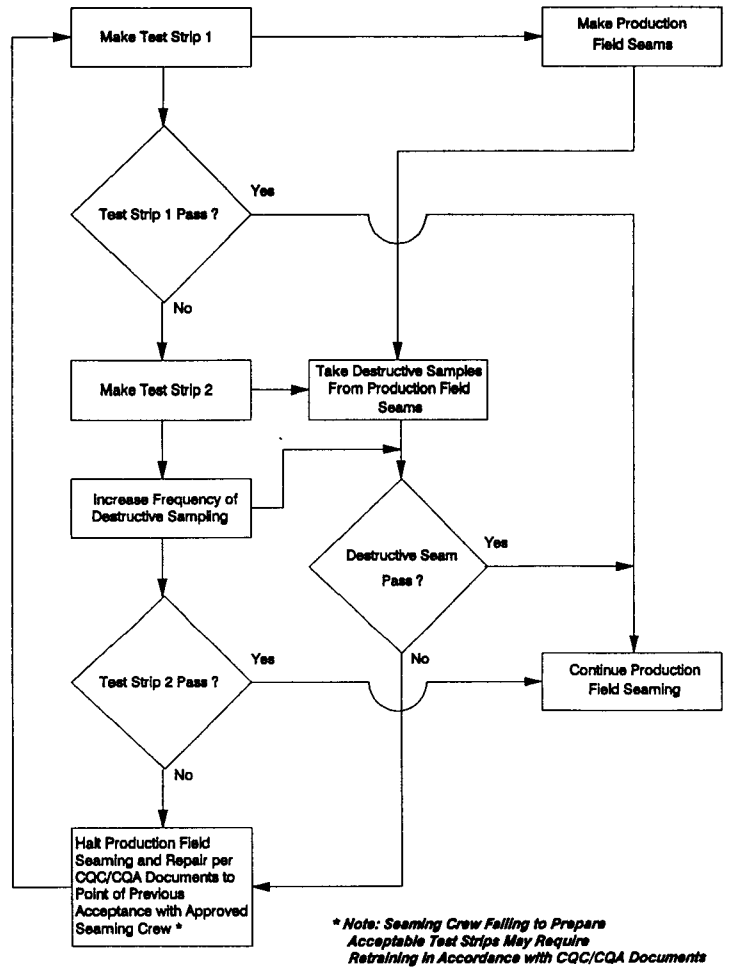

Figure 9.5. Test strip process flow chart.

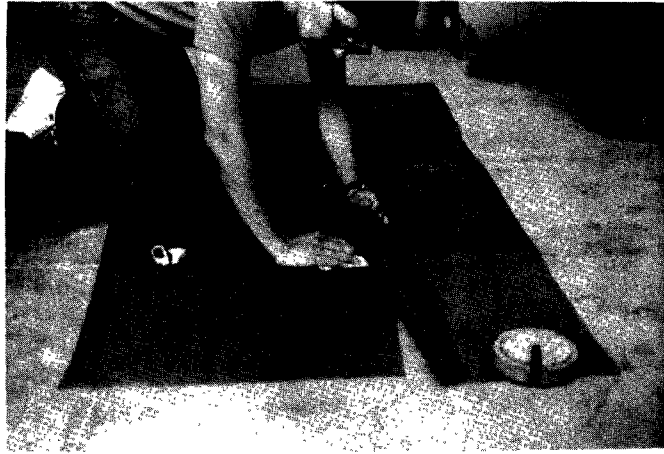

Figure 9.6(a). Alignment of test strip and cleaning of area to be bonded.



Figure 9.6(b). Applying fusion chemical to area of lower geomembrane to be bonded.

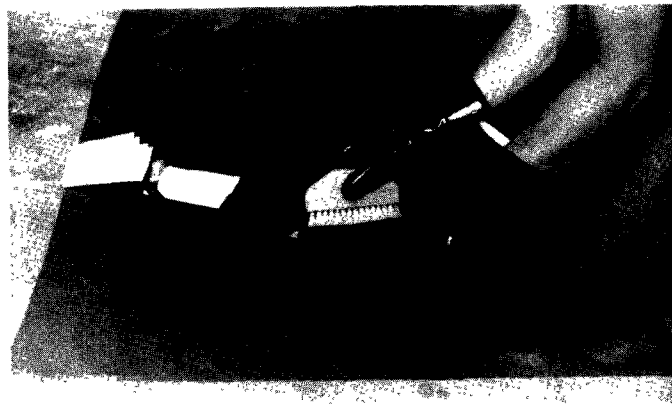

Figure 9.6(c). Smoothing and rolling bonded area.



Figure 9.6(d). Cutting the test strip samples for appropriate groups for testing or storage.

testing. Volatile chemical odors should no longer be detected. The exact procedures should be specifically written into the CQC/CQA Documents.

During the CQC and CQA test requirement periods, a liner should not be covered and it cannot be placed into service. This will insure the ease of repairing or reconstructing in the event it is required. During this period it is imperative that the liner be properly ballasted and otherwise secured so as to prevent wind or unusual weather damage.

9.4 ACTUAL SEAMING PROCESS

- (a) Position the geomembrane panels so that the entire length of the seam area overlaps. If required for site specific considerations, place the desired length of seaming board or slip sheet beneath the seam and correctly position it so as to provide a good working surface for the area to be seamed, see Figure 9.7.
- (b) Use a fine bristle brush, clean rags, or other means to remove soil particles or dust from the area to be seamed.
- (c) If two seaming crews can work simultaneously on the same seam, begin seaming at the mid-point of the geomembrane panels and work toward the ends. This tends to prevent fishmouths occurring in the center of the panel. On slopes, seaming should proceed uphill.
- (d) In constructing field seams one invariably encounters areas where three thicknesses of material need to be bonded together. These areas occur at the intersection of factory and field seams and are known as "T" connections, see Figure 9.8 for schematic representation of the "T" connection. Either additional fusion chemical should be used in these areas to bond the loose flap or the loose portion of the flap should be trimmed off.
- (e) A "T" trimming tool in action is pictured in Figure 9.9 showing the trimming of the flap in the lower geomembrane. The "T" trimming tool resembles a cheese cutter with a replaceable razor blade cutting edge. It is only used to trim nonreinforced geomembranes like PVC or unreinforced CSPE and CPE and then only for geomembranes greater than 0.75 mm (30 mils).

For reinforced geomembranes one should discourage this type of trimming because it exposes the scrim reinforcement. Such exposed scrim should be avoided since moisture and/or leachate could wick up the scrim and cause delamination or other undesirable effects. Reinforced geomembranes should be trimmed as accurately as possible with a razor hook knife, with a backing to prevent damage to the underlying geomembrane. In all locations where the ends of scrim are exposed one should use bodied adhesive chemicals or sealants which, due to their higher viscosity, can be more generously applied (called "flood coating") in these regions. All exposed scrim should be sealed.

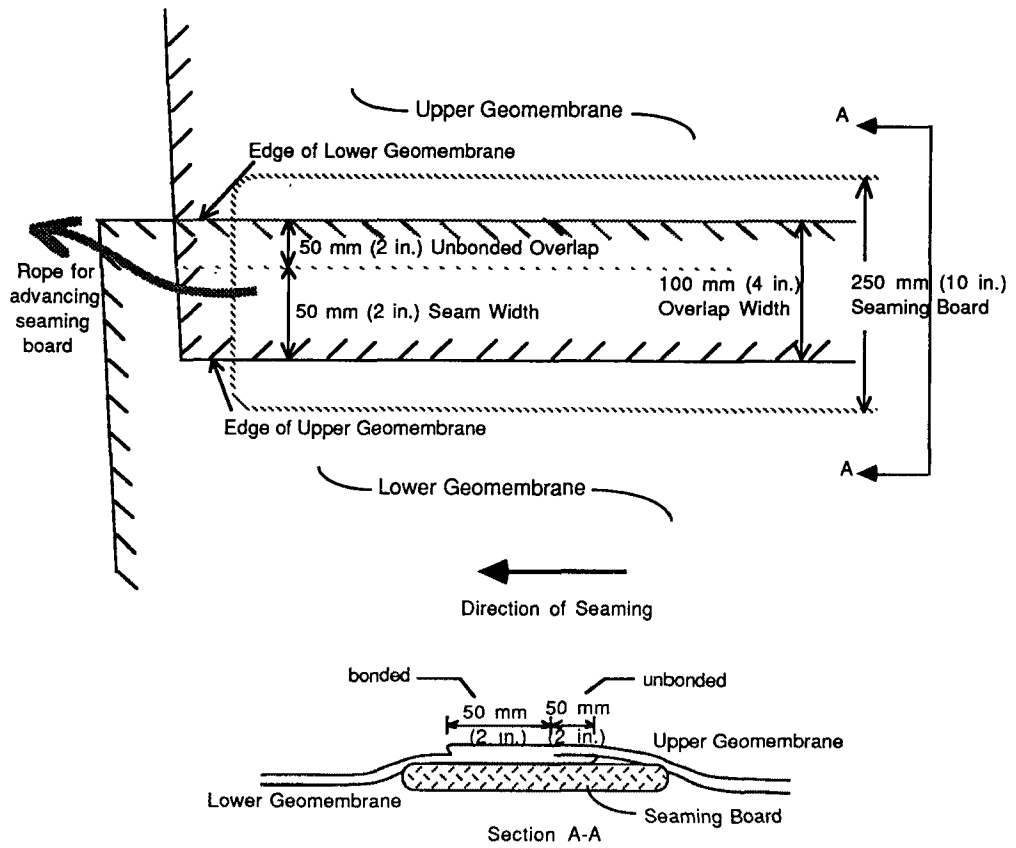

Figure 9.7. Positioning of wooden "seaming board" beneath seam area of liner to provide for a uniform and smooth subsurface.

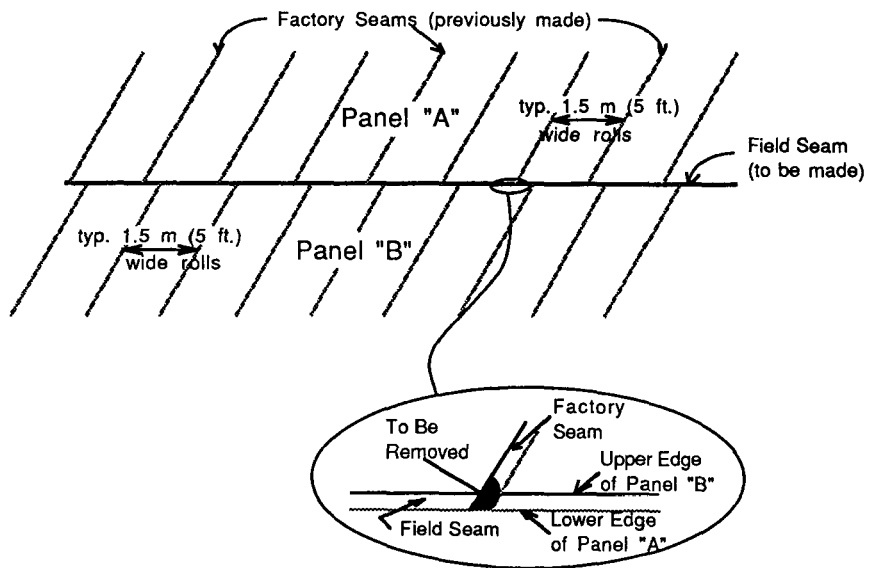

Figure 9.8. Perspective diagram of locations where "T" configurations commonly occur.



Figure 9.9. Photograph of "T" trimming tool shaving the upper surface of an existing seam in preparation of new intersecting seam.

- (f) The appropriate fusion chemical is applied with an applicator (squeeze bottle or brush) until it completely wets the bottom geomembrane. Care must be taken to make sure that enough fusion chemical is applied to wet and fuse both surfaces that are being seamed. This adequate coverage can be seen since properly wetted areas appear different than non-wetted areas. Any excess fusion chemical should be wiped up quickly to prevent puddling, which could damage the geomembrane, see Figure 9.10.
- (g) After applying the fusion chemical, an "initial reaction" time, or "dwell" time is required for the chemical to soften the surface of the geomembrane sheet. Dwell times for various thicknesses of different geomembranes are from 2 to 5 seconds. Note that high ambient temperatures, strong wind, and low relative humidity all tend to reduce the time necessary for the fusion chemical to soften the surface of the sheet. Therefore, if these conditions exist, the "dwell time" will be decreased. The determination of dwell time emphasizes the importance of the preparation and testing of test strips which were described earlier.
- (h) Following the dwell time, the two liner surfaces are mated together and pressure is applied to the upper surface. The pressure is applied with a roller or other suitable pressure device. The process involves rolling the seam both in a parallel and a perpendicular or 45 degree direction so as to mate and fuse the two liner surfaces, remove air pockets, and to force any excess fusion chemical toward and out of the exposed overlap edge. The seaming technician should make a sufficient number of passes with the roller to insure that both surface mating and excess chemical removal has been accomplished. Generally between 5-10 passes in each direction over a 60 cm (2 ft.) length will be needed, see Figure 9.11(a-b). However, the use of any alternative chemical or pressure applicators must be evaluated with test strip seams.
- (i) Rolling should be accomplished using uniform pressure in a flowing motion. This will lead to an acceptable seam with no entrapped vapor or air pockets. Excessive pressure, e.g. pressure that would cause the material to indent or crease, is not required.
- (j) After applying pressure to a section of seam, any excess fusion chemical should be wiped off the top of the geomembrane. Wipe toward the leading edge of the seam not away from it. For reinforced geomembranes it is desirable to see a small bead of fusion chemical extend to the outer edge of the seam.
- (k) Clean pressure applicators should be used at all times. When a roller is used, a clean surface must be maintained.

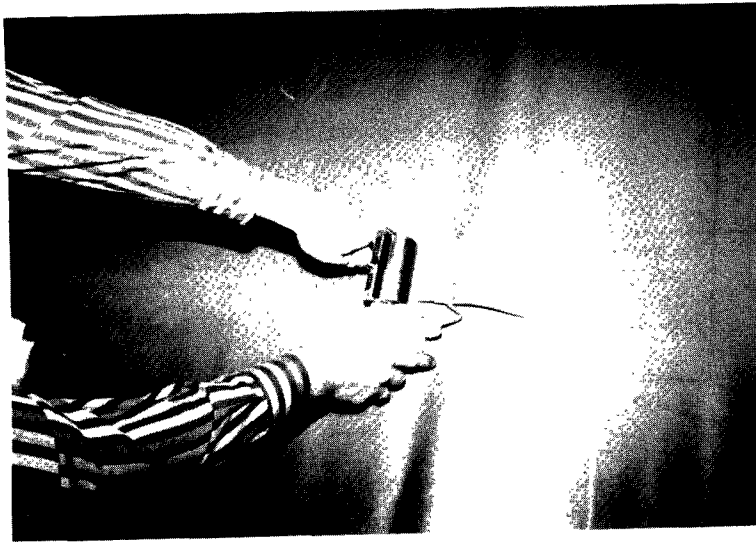

Figure 9.10. Application of fusion chemical.

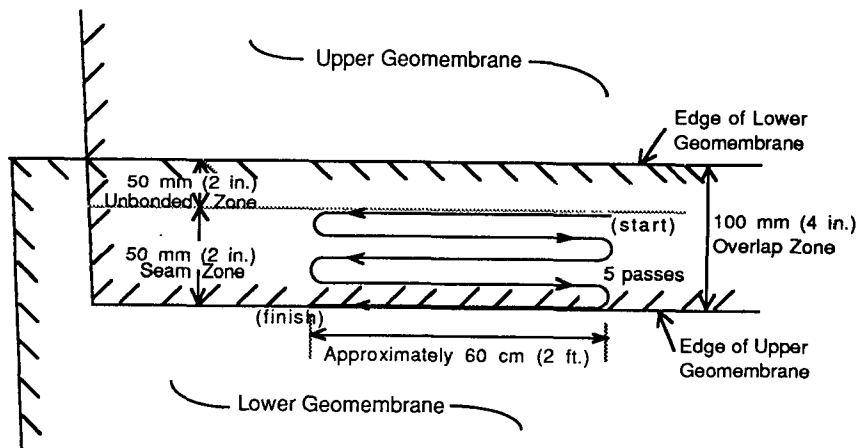

Figure 9.11(a). Parallel rolling motion for the fabrication of chemically fused seams.

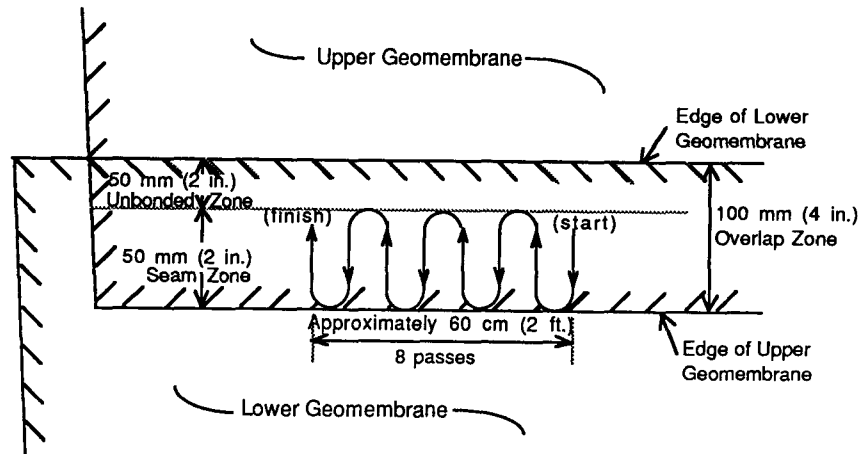

Figure 9.11(b). Perpendicular rolling motion for the fabrication of chemically fused seams.

9.5 AFTER SEAMING

- (a) The seam must be checked visually for uniformity of width and surface continuity. As stated earlier, proper fusion chemical application visually changes the surface appearance. Usually the installer will use an air lance or blunt-end pick, see Figure 9.12(a-b), to check for voids or gaps under the overlapping geomembrane.
- (b) When unbonded areas are located, they can sometimes be repaired by inserting more bonding agent into the opening and applying pressure. If that is not satisfactory, a patch must be placed over them with at least 15 cm (6 inches) of geomembrane extending on all sides.
- (c) Any area of the geomembrane sheets where fusion chemical accidentally spilled and caused damage greater than 10% of the original thickness, must be patched as above, with at least 15 cm (6 inches) of geomembrane extending beyond the affected areas.
- (d) Any area of the geomembrane sheets where puncture holes are observed must be patched as above, with at least 15 cm (6 inches) of geomembrane extending beyond the affected areas.



(a) Air lance test.

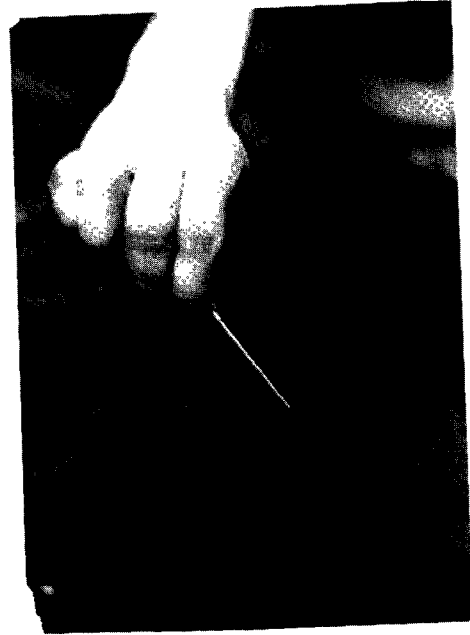

(b) Pick test.

Figure 9.12. Photographs of air lance and pick testing of completed seam.

- (e) Note that with the above three repair items (b, c, and d) it is not practical to use a seaming board beneath the geomembrane. However, a piece of the liner material can be used for added support under the liner, if needed, even if the hole must be enlarged to insert the piece before the patch is made. This added piece is left there indefinitely. In either situation, additional care should be used to insure a proper bond.
- (f) At the completion of seaming, all rags, chemical containers, etc., should be properly removed from the geomembrane.
- (g) Sand bags used to resist wind uplift stresses may be placed on the seamed areas in accordance with customary installation practice, as prescribed in the contract specifications, or CQC/CQA Documents.
- (h) Cross sections of the completed seams are shown in Figure 9.13(a-c).

9.6 UNUSUAL CONDITIONS

This section is written to give insight into conditions which go beyond the general description just presented.

- (a) High winds, or gusts of wind, are always problematic for liners. After deploying the geomembrane, the panels should be adequately ballasted, e.g., with sandbags. The actual seaming operation, however, may require the removal of some of the ballast leaving the windward edge vulnerable to wind uplift forces. If possible, proper orientation of the overlap might be helpful. Otherwise, additional labor may be required to only remove sandbags immediately in front of the seaming operation. The liner must be cleaned of any dirt and moisture left behind after sandbag removal. They are then to be replaced behind the completed seaming operation.
- (b) Patches are invariably necessary to make at locations where destructive test samples are removed or where seams are shown to fail nondestructive testing. These patches must extend a minimum of 15 cm (6 inches) beyond the outer limits of the area to be repaired. Since a seaming board cannot be used in these areas, additional care is necessary. Sometimes excess pieces of geomembrane material, which are left in place, are positioned beneath the area to be seamed.

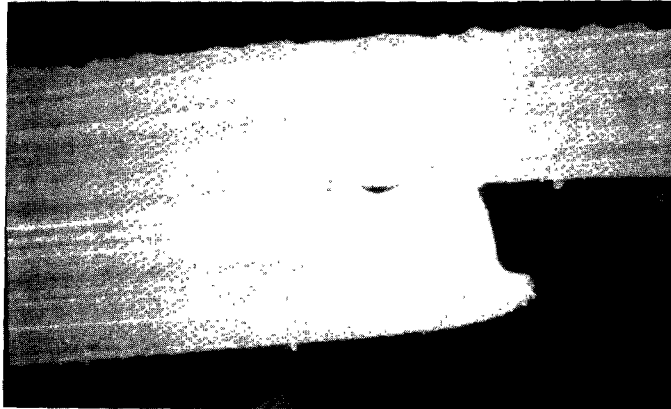

Figure 9.13(a). Cross sections of PVC liner seams prepared by the chemical fusion method showing left side of completed seam.

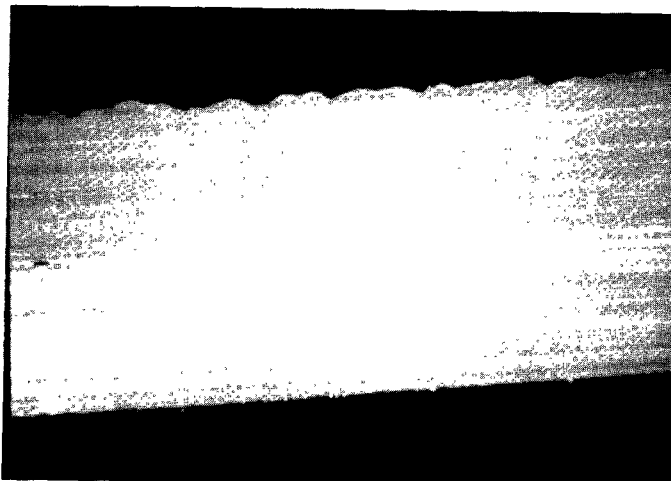

Figure 9.13(b). Cross sections of PVC liner seams prepared by the chemical fusion method showing center of completed seam.

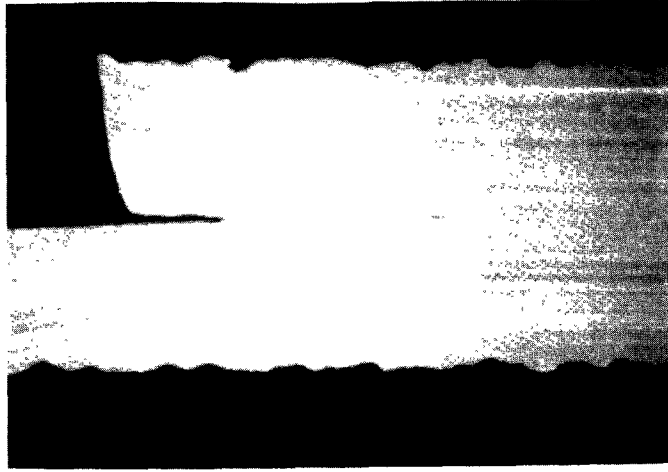

Figure 9.13(c). Cross sections of PVC liner seams prepared by the chemical fusion method showing right side of completed seam.

- (c) Details around sumps, pipes and other appurtenances are perhaps the most demanding locations to properly seam in an entire facility. Also due to their typical locations being at low points of the containment facility's design, these areas inherently operate under larger hydraulic heads. Should a defect from improper seaming occur in such a location leakage rates and its associated adverse impacts are heightened. Therefore, extreme care should be exercised in ensuring seam integrity in these often difficult to reach locations. The fusion chemical should be placed symmetrically on both liners to be joined which may be difficult for external and internal edges and particularly at corners. Hand and finger pressure may be needed in tight areas.
- (d) This section was written for material temperatures that range between 0°C (32°F) and 50°C (122°F). This is the temperature range that is generally recognized as being acceptable for seaming without taking special precautions.

For sheet temperatures below 0°C (32°F), shielding, pre-heating, different chemical compounds and/or a slower seaming rate may be required. More frequent seam testing and precautions to prevent thawing subgrade (previously discussed) may have to be taken. Sharp, frozen subgrade should be avoided to eliminate point pressure damage potential.

For sheet temperatures above 50°C (122°F) shielding and rate of seaming should be adjusted. More frequent destructive seam testing may have to be taken.

FIELD NOTES:

FIELD NOTES:



SECTION 10

DETAILS OF CHEMICAL ADHESIVE SEAMS

As is shown in Table 4.2, chemical adhesive seaming represents an applicable field seaming method for PVC, CPE, EIA, CSPE liners, both reinforced and unreinforced. Adhesives differ from other bonding agents in that they necessarily contain materials that are dissimilar to the liner material itself. In addition to seaming adhesives, they are also sometimes used to seal exposed fabric or scrim. This section focuses only on the use of adhesives for seaming compounded thermoplastic and thermoplastic elastomeric geomembranes.

10.1 GEOMEMBRANE PREPARATION

- (a) Note that this document assumes that the proper geomembrane has been visually inspected to ensure it is free of deep scratches or defects that would cause the sheet to not meet the specifications of the installation. It is further assumed the sheet has been delivered to the site and brought to its approximate plan position (as per design the panel layout) for final installation and seaming. Only the material that can be seamed that day should be deployed. All deployed material should be ballasted immediately to prevent wind uplift.
- (b) The geomembrane will usually arrive on site in the form of prefabricated panels which are accordion-folded in both directions. These panels are usually packaged in palletized, heavy weatherable cardboard containers.
- (c) The geomembrane should remain packaged and dry until ready for use. The material should not be unfolded when material temperatures are lower than -10°C (14°F) due to the possibility of cracking. If the panel is stored in a warm place, e.g. 10°C (50°F) or above, prior to being unfolded or unrolled on site, then it can be placed at -18°C (0°F) or below temperatures providing the time between removing the geomembrane from storage and deployment does not exceed one-half working day. Geomembrane deployment may be allowed for other conditions but the CQC/CQA Documents must be specific as to the conditions.
- (d) All personnel walking on the geomembrane should have smooth soled shoes. Heavy equipment, e.g. pickups, tractors, etc., should not be allowed on the geomembrane at any time, unless otherwise specified by the manufacturer and approved in the CQC/CQA Documents.

- (e) The two geomembrane sheets to be joined must be properly positioned such that approximately 15 cm (6 inches) of overlap exists. If the overlap is insufficient, lift the geomembrane sheet up and down to allow air to be pumped beneath it and "float" it into proper position.
- (f) If the overlap is excessive, the excess material may be trimmed with scissors or worked away from the edges of the seam to maintain proper overlap, as shown in Figure 10.1 (a-b). All cut scrim edges must be sealed with a flood coat of bodied adhesive or the manufacturer's/fabricator's approved liquid sealant.
- (g) When reinforced geomembranes are cut to accommodate odd shapes or to fit small pieces, resealing of the exposed scrim by flood coating is required by the use of manufacturer's or fabricator's approved liquid adhesive. This adhesive is usually a thickened chemical of the same type used to do the production seaming as described in Section 9.
- (h) All cutting and preparation of odd shaped sections or small fitted pieces can be accomplished at the discretion of the installer so that production field seaming can be completed with as few interruptions as possible.
- (i) The two opposing geomembrane sheets to be joined should be visually checked for defects of sufficient magnitude to affect seam quality. The criteria to be met and the procedures to be used in this regard should be stipulated in the contract specifications and/or in the CQC/CQA Documents.
- (j) If the construction plan requires overlaps to be shingled in a particular direction, this should be checked.
- (k) Excessive undulations (waves) along the seams during the seaming operation should be avoided. When this occurs due to either the upper or lower sheet having more slack than the other or because of thermal expansion and contraction, it often leads to the undesirable formation of "fishmouths" which must be trimmed, laid flat and resealed with a patch. An example of a fishmouth and its correction is shown in Figure 10.2.(a-d).
- (l) There should be some slack in the installed liner which depends on the type of geomembrane, the ambient and anticipated service temperatures, length of time the geomembrane will be exposed, location of the facility, etc. This is a design consideration and the plans and specifications must be project specific on the amount and orientation of this slack.
- (m) The sheets which are overlapped for seaming must be clean. If dirty, they must be wiped clean with dry rags. If processing aids were used in the manufacture of the sheet, this must be removed.

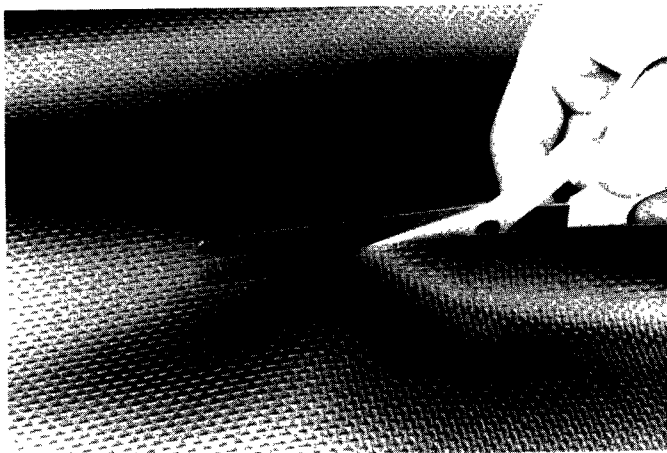

Figure 10.1(a). Trimming of excess geomembrane sheet to obtain proper overlap prior to seaming.

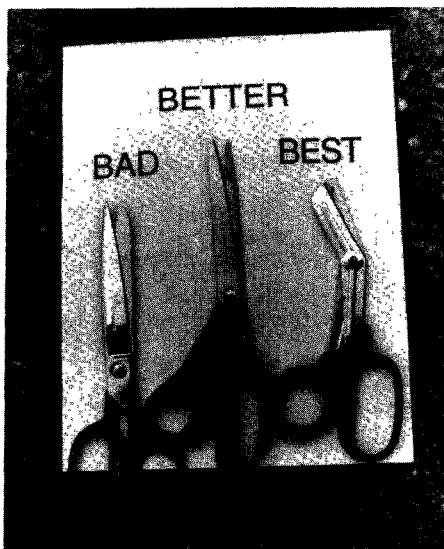

Figure 10.1(b). Type of scissors recommended for cutting of geomembrane sheets.



Figure 10.2(a). Formation of "fishmouth" resulting from excessive slack in upper geomembrane versus lower geomembrane

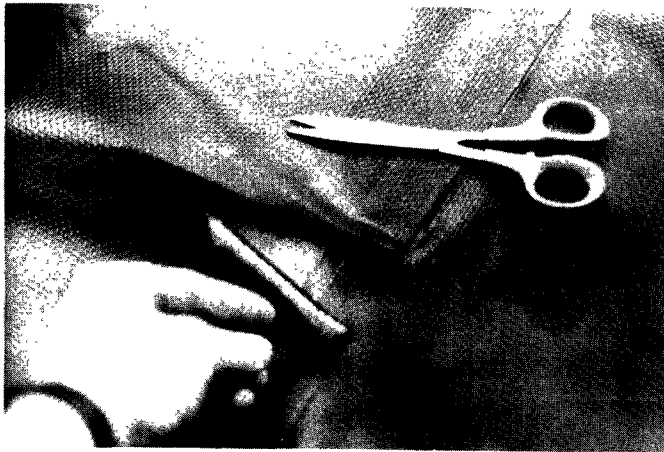

Figure 10.2(b). Cutting of "fishmouth" along its centerline



Figure 10.2(c). Overlapping and seaming the ends of the upper geomembrane to the lower geomembrane.

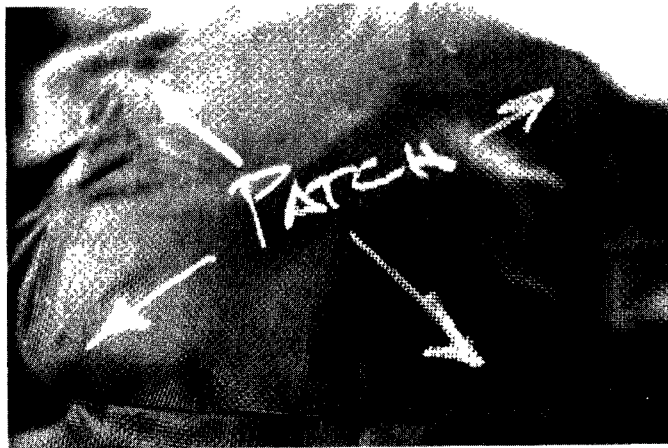

Figure 10.2(d). Patch over the entire area where "fishmouth" was located.

- (n) The sheets which are overlapped for seaming must be completely free of moisture in the seam area.
- (o) Seaming is not allowed during rain or snow, unless proper precautions are made to allow the seam to be made on dry geomembrane sheets, e.g., within an enclosure or shelter.
- (p) It is preferable not to have water-saturated soil beneath the geomembrane during installation. Seaming boards help in this regard by lifting the seams off the soil subgrade.
- (q) If the soil beneath the geomembrane is frozen, the heat from hot air guns and radiant lamps can thaw the frost allowing water to be condensed onto the unbonded region ahead of the seam being fabricated. This possibility may be eliminated by the use of suitable seaming boards or slip sheets made from the excess geomembrane.
- (r) Ambient temperatures for seaming should be above freezing, i.e. 0°C (32°F), unless it can be proven with test strips that good seams can be fabricated at lower temperatures. However, temperature is of less concern to good seam quality than is moisture.
- (s) For cold weather seaming, it may be advisable to preheat the sheets with a radiant heater, hot air blower, or to use a tent of some sort to prevent heat losses during seaming and to make numerous test seams in order to determine appropriate seaming conditions.
- (t) Sheet temperatures for seaming should be below 50°C (122°F) as measured by an infrared thermometer or surface contact thermocouple. It is recognized that depending on material type and thickness, higher temperatures may be allowed. It should also be recognized that wind and cloud cover will determine the actual sheet temperature. High temperatures affect not only worker performance, but may also affect seam durability of some geomembranes unless special precautions are taken. For temperatures above this value special attention should be paid to the seaming, frequent test strips and more diligent nondestructive testing is recommended.
NOTE: For items (q), (r), (s,) and (t) the CQC/CQA Documents and/or project specifications and the regulatory requirements regarding hot and cold temperature seaming limitations should be reviewed to avoid possible problems with final construction certification acceptance.

10.2 EQUIPMENT PREPARATION

- (a) An ample supply of the appropriate adhesive must be available at the job site. It should be stored at room temperature and sheltered from the elements. Chemical adhesives that have been

left open and started to solidify should not be remixed or used. Storage is to be away from any portion of the geomembrane so that accidental spillage can not occur on the liner itself or over a diked retaining pad or impoundment, so that chemicals cannot penetrate the ground. The listed shelf life cannot be exceeded.

- (b) A 5 cm to 10 cm (2 to 4 inches) wide paint brush will be needed to apply adhesive to the area to be bonded. The bristles must be made from materials which are not softened or dissolved by the adhesive.
- (c) At least one clean paint can of a minimum capacity of 1/4 l (1 pt.) will be needed by each seaming crew. The can should only be filled one third full to avoid spillage during the seaming process.
- (d) A soft bristled brush and numerous rags will be needed to clean the geomembrane to be seamed as well as wipe away any excess adhesive after seaming. The brush and rags should be chemically resistant to the adhesive.
- (e) Pressure applicators including rollers, either steel, rubber, nylon or wood depending on site specific conditions, from 5 to 9 cm (2 to 3-1/2 inches) wide, will be needed for applying pressure to the bonded area after the adhesive has been applied. Figure 10.3 illustrates the types of rollers in common use. Pressure applied with a rag or wood paddle has been successfully used in place of a roller to achieve a good seam.

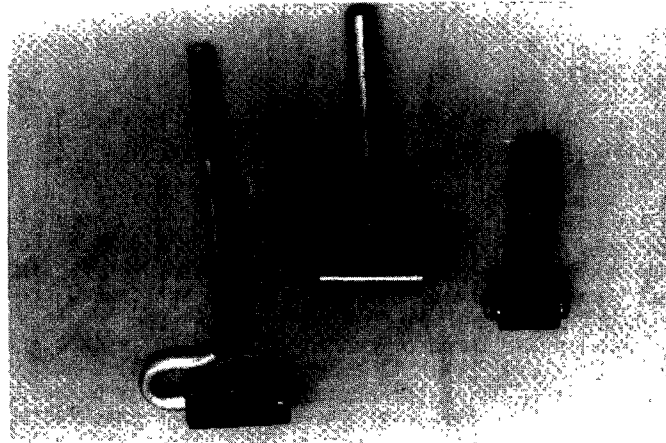

Figure 10.3. Photograph of types of rollers used to apply pressure to solvent adhesive seams.

- (f) An ample supply of adhesive resistant gloves will be necessary to eliminate the possibility of the adhesive coming in contact with the skin.
- (g) Seaming boards made from wooden planks or slip sheets should be available. The seaming boards must be smooth with rounded corners and edges and have a hole drilled at one end for attaching a pull rope. If needed, they may serve as temporary working platforms placed beneath the seaming area to provide a smooth surface and a base for physical resistance to the applied pressure of the rollers. They also provide insulation to heat and help keep dirt and moisture away from the seaming area.
- (h) Hot air guns or other appropriate heating devices are necessary to heat the geomembrane when performing cold temperature field seaming.
- (i) For cold temperature seaming, properly functioning electric generators to power the heating devices or heat guns, must be available within close proximity of the seaming region and with adequate extension cords to complete the entire seam. These generators should be of sufficient size or numbers to handle all seaming electrical requirements. The generator must have rubber tires, or be placed on a smooth plate such that it is completely stable in order that it will not damage the geomembrane. Fuel (gasoline or diesel) for the generator must be stored away from the geomembrane and if accidentally spilled on the geomembrane must be immediately removed. The area should be inspected for damage to the geomembrane and repaired if necessary.

10.3 TEST STRIPS

A general requirement of most CQA Documents is that "test seams" or "test strips" be made on a periodic basis. Test strips generally reflect the quality of field seams but should never be used solely for final field seam acceptance. Final field seam acceptance should be specified in the contract specification and should include a minimum level of destructive testing of the production field seams. Test strips are made to minimize the amount of destructive sampling/testing which requires subsequent repair of the final field seam. Typically these test seams, for each seaming crew, are made about every four hours, or every time equipment is changed, or if significant changes in geomembrane temperature are observed, or as required in the contract specification. This is a recommended practice that should be followed when seaming all types of geomembranes. The purpose of these tests is to establish that proper seaming materials, temperatures, pressures, rates, and techniques along with the necessary geomembrane pre-seaming preparation is being accomplished. Test strips may be used for CQA/CQC evaluation, archiving, for exposure tests, etc., and must be of sufficient length to satisfy these various needs.

Each seaming crew and the materials they are using must be traceable and identifiable to their test seams. While the test seams are being prepared, cured, and CQC tested, the seaming crew may continue to work as long as the seams they have made (and are making) since their last acceptable test sample strip was prepared, are completely traceable and identifiable. If a test seam fails to meet the field seam design specification, then an additional test seam sample will have to be made by the same seaming crew - using the same tools, equipment and seaming materials - and retested.

The liner's finished field seams will not be accepted unless the before and after "test seam sample strip" CQC test results (or other CQC seam test result criteria as required per the design specification) are acceptable per the site's design specifications. If a seam is not accepted, destructive testing of samples from the actual seam will be removed from the liner and tested. If the actual seam destructive test results still do not meet the design specification requirement, then the unacceptable seams will all have to be repaired or reconstructed with seaming materials by a test proven seaming crew that has passed its testing requirements. The procedure illustrated in the flow chart of Figure 10.4. must be followed. Note that the failure of test strip 1 requires two actions: (a) the making of test strip 2, and (b) an increased frequency of destructive tests on production field seams made during the curing of test strip 1 (if any were made). This increased frequency must be stipulated in the contract specifications or in the CQC/CQA Documents.

If the destructive seams fail or if test strip 2 fails, production field seaming is halted. All production field seams made during the interval are repaired per the contract specifications or CQC/CQA Documents to the point of previous acceptance with an approved seaming crew.

At this point, the seaming crew that failed to pass both strip tests must adjust and recertify current seaming equipment and technique or obtain new seaming equipment, tools and/or retrain personnel and begin making initial test strip samples.

For adhesive seams, test strips of the type shown in Figure 10.5(a-e) are prepared. The seam is centered lengthwise between the two sheets to be joined. Figure 10.5 (a) shows the two geomembrane pieces to be seamed being cleaned and properly aligned, 10.5 (b) shows chemical adhesive being applied to bonding area, 10.5 (c) shows adhesive in "tack" stage, 10.5 (d) shows samples being cut from completed test strips for subsequent destructive testing and 10.5 (e) shows the individual samples cut from the test strip being identified.

For geomembranes that are seamed by adhesive methods, on site CQC testing requires time that, without accelerated curing, can range from a few hours to days. Accelerated curing of seam test samples using an oven on site, or another suitable heat source, can be accomplished at temperature ranges between 50°C (122°F) and 70°C (158°F) within periods that range from 1 hour to 16 hours, dependent upon the following variables: material type, thickness, adhesive system, seam width, etc. After the accelerated curing period the samples are allowed to cool at least 1/2 hour prior to peel and tensile/shear

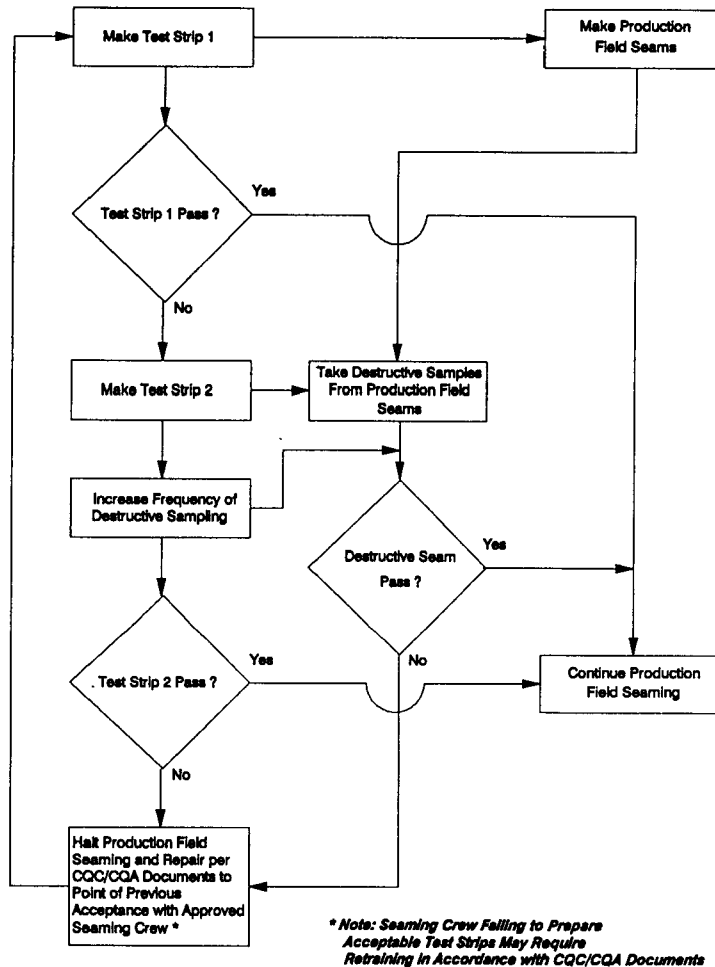

Figure 10.4. Test strip process flow chart.



Figure 10.5(a). (Upper Left) Alignment of test strip and cleaning of area to be bonded.

Figure 10.5(b). (Lower Right) Applying chemical adhesive to area of lower geomembrane to be bonded.

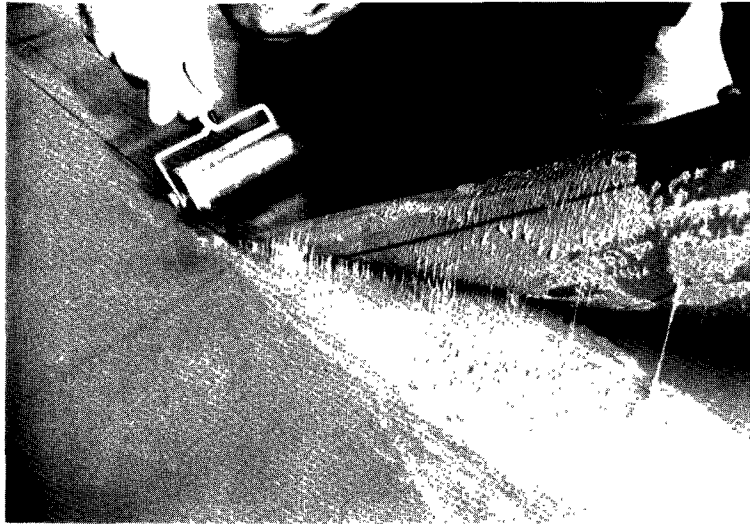

Figure 10.5(c). Adhesive in the "tack" stage.



Figure 10.5 (d). Cutting samples from completed test strips.



Figure 10.5(e). Marking the test strip samples for appropriate groups for testing or storage.

testing. Volatile chemical odor should no longer be detected. The exact procedure should be specifically written into the CQC/CQA Documents.

During the CQC and CQA test requirement periods, a liner should not be covered and it cannot be placed into service. This will insure the ease of repairing and reconstructing in the event it is required. During this period it is imperative that the liner be properly ballasted and otherwise secured so as to prevent wind or unusual weather damage.

10.4 ACTUAL SEAMING PROCESS

- (a) Position the geomembrane panels so that the entire length of the seam area overlaps. If required for site specific considerations, place the desired length of seaming board or slip sheet beneath the seam and correctly position it so as to provide a good working surface for the area to be seamed, see Figure 10.6.
- (b) Use a fine bristle brush or rag to remove soil particles or dust from the area to be seamed.
- (c) If two seaming crews can work simultaneously on the same seam, begin seaming at the mid-point of the geomembrane panels and work toward the ends. This tends to prevent fishmouths occurring in the center of the panel. On slopes, seaming should proceed uphill.

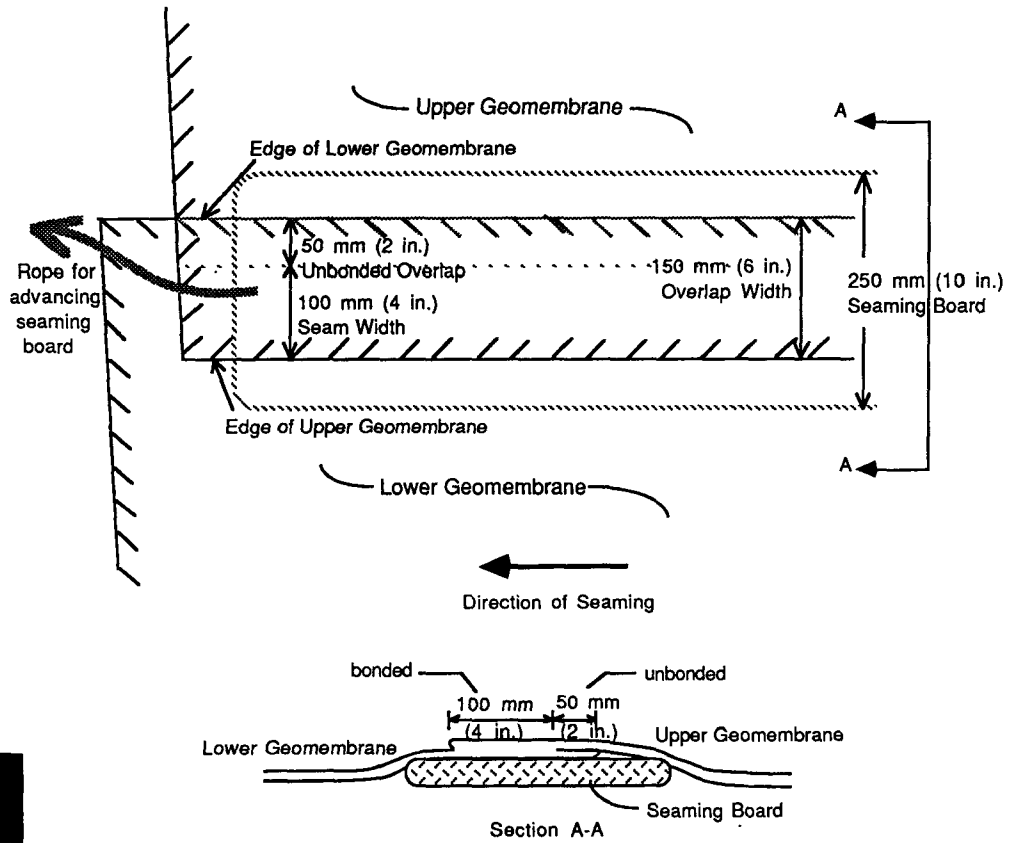

Figure 10.6. Positioning of wooden seaming board beneath seams of CPE, CPE-R, CSPE-R, or PVC liners to provide for a uniform and smooth subsurface.

- (d) In constructing field seams one invariably encounters areas where three thicknesses of material need to be bonded together. These areas occur at the intersection of factory and field seams and are known as "T" connections, see Figure 10.7 for schematic representation of the "T" connection. Either additional adhesive should be used in these areas to bond the loose flap or the loose portion of the flap should be trimmed off, see Figure 10.8.

For reinforced geomembranes one should discourage this type of trimming because it exposes the scrim reinforcement. Such exposed scrim should be avoided since moisture and/or leachate could wick up the scrim and cause delamination or other undesirable effects. Reinforced geomembranes should be trimmed as accurately as possible with a razor hook knife, with a backing to prevent damage to the underlying geomembrane. In all locations where the ends of scrim are exposed one should use bodied adhesive chemicals or sealants which, due to their higher viscosity, can be more generously applied (called "flood coating") in these regions. All exposed scrim should be sealed.

- (e) Adhesive is applied uniformly to the bottom of the upper sheet and to the top of the lower sheet. This is a critical part of the adhesive seaming process. Care must be taken to make sure that enough adhesive is applied to wet and fuse both surfaces that are being seamed. This adequate coverage can be seen visually since properly wetted seams look different from non-wetted areas. Excess adhesive must be wiped up quickly and prevented from puddling, which could damage the geomembrane.
- (f) After applying the adhesive, a dwell time is required for the adhesive to soften the surface of the geomembrane sheets. Dwell times for various thicknesses of different geomembranes are from 2 to 5 seconds. Note that high ambient temperatures, strong wind, and low relative humidity all tend to reduce the time necessary for the adhesive to soften the surface of the sheet. Therefore, if these conditions exist, the "dwell time" will be decreased. The determination of dwell time emphasizes the importance of the preparation and testing of test strips which were described earlier.
- (g) Following the dwell time, the two liner surfaces are mated together and pressure is applied to the upper surface. The pressure is applied with a roller or other suitable pressure device. The process involves rolling the seam both in a parallel and perpendicular or 45 degree direction so as to mate and fuse the two surfaces, to remove air pockets, and to force any excess adhesive toward and out of the exposed overlap edge, see Figure 10.9(a-b). The seaming technician should make a sufficient number of passes with the roller to insure that both surface mating and excess adhesive removal have been accomplished. Generally between 5-10 passes in each direction over a 60 cm (2 ft.) length will be needed. However, the use of any alternative adhesive or pressure applicator

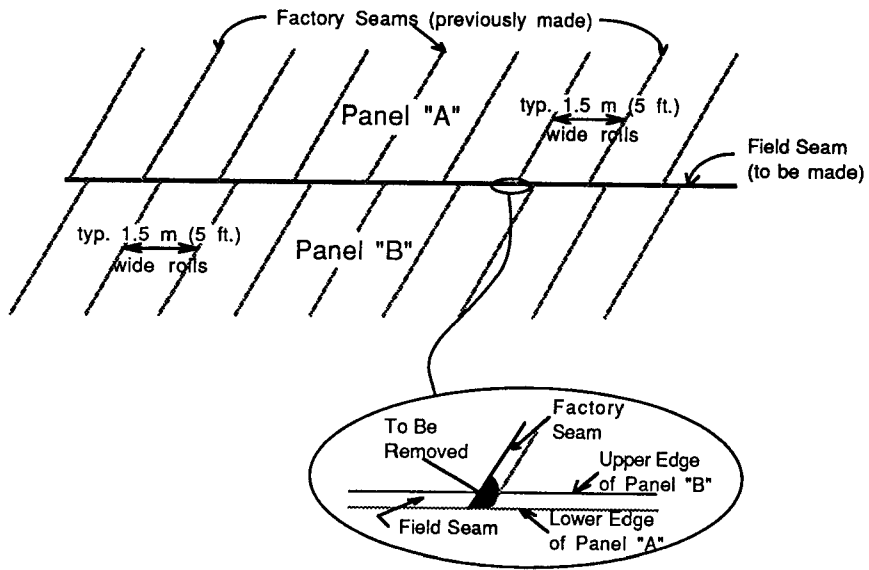

Figure 10.7. Perspective diagram of locations where "T" configurations commonly occur.



Figure 10.8. Photograph of "T" trimming tool shaving the upper surface of an existing seam in preparation of new intersecting seam.

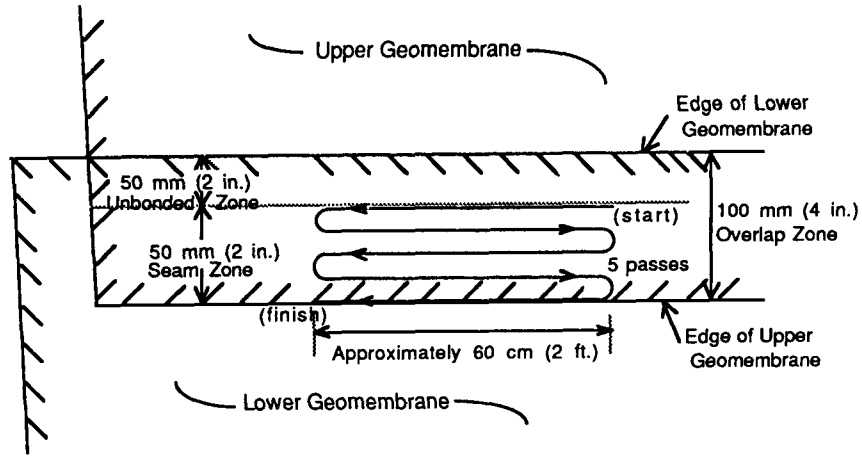

Figure 10.9(a). Initial rolling motion parallel to seam for the fabrication of adhesive seams for CPE, CSPE, EIA or PVC liners.

must be evaluated on the test strip seams. The area that is rolled or pressed must be continuous.

- (h) Rolling should be accomplished at a somewhat tacky stage using uniform pressure in a flowing motion, see Figure 10.9(b). This will lead to an acceptable seam with no entrapped vapor or air pockets. Excessive pressure is not required.

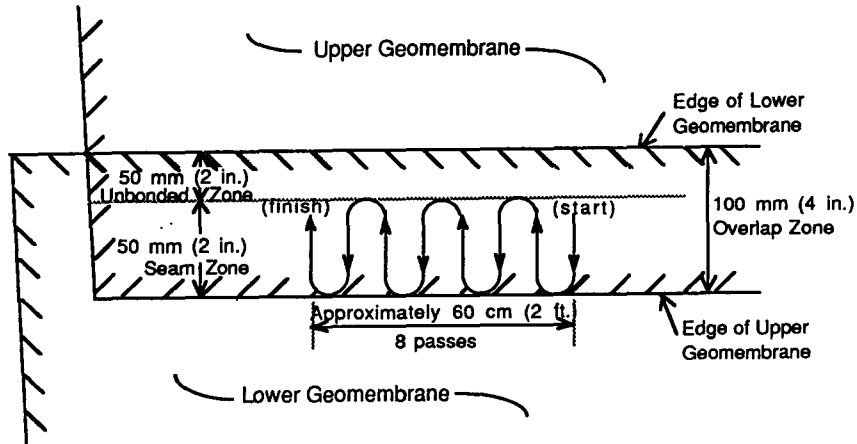

Figure 10.9(b). Final rolling motion perpendicular to seam for the fabrication of adhesive seams for CPE, CSPE, EIA or PVC liners.

- (i) After rolling a section of seam, any excess adhesive should be wiped off the top of the geomembrane. Wipe toward the leading edge of the seam not away from it. For reinforced geomembranes it is desirable to see a small bead of adhesive at the outer edge of the seam.
- (j) With this seaming method the adhesive remains in the bonded area and becomes a component of the seam.
- (k) Clean pressure applicators should be used at all times. When a roller is used, a clean surface must be maintained.

10.5 AFTER SEAMING

- (a) The seam must be checked visually for uniformity of width and surface continuity. As stated earlier, proper adhesive application visually changes the surface appearance. Usually the installer will use an air lance or blunt-end pick, see Figure 10.10(a-b), to check for voids or gaps under the overlapping geomembrane.
- (b) When unbonded areas are located, they can sometimes be repaired by inserting more adhesive into the opening and rolling. If that is not satisfactory, a patch must be placed over them with at least 15 cm (6 inches) of geomembrane extending on all sides.
- (c) Any area of the geomembrane sheets where adhesive accidentally spilled and caused damage greater than 10% of the original thickness, must be patched as above with at least 15 cm (6 inches) of geomembrane extending beyond the affected areas.
- (d) Any area of the geomembrane sheets where puncture holes are observed must be patched as above with at least 15 cm (6 inches) of geomembrane extending beyond the affected areas.
- (e) Note that with the above three repair items (b, c, and d) it is not practical to use a seaming board beneath the geomembrane. However, a piece of the liner material can be used for added support under the liner, if needed, even if the hole must be enlarged to insert the piece before the patch is made. This added piece is left there indefinitely. In either situation, additional care is necessary to insure a proper bond.
- (f) Sandbags used to resist wind uplift stresses may to be placed on the seamed areas in accordance with customary installation practice or as prescribed in the contract specifications.
- (g) Cross sections of the completed seams are shown in Figure 10.11(a-c).



(a) Air lance test.



(b) Pick test.

Figure 10.10. Photographs of air lance and pick testing of completed seam.



Figure 10.11(a). Cross sections of CSPE-R seams fabricated by the chemical adhesive seaming method showing left side of completed seam.



Figure 10.11(b). Cross sections of CSPE-R seams fabricated by the chemical adhesive seaming method showing center side of completed seam.



Figure 10.11(c). Cross sections of CSPE-R seams fabricated by the chemical adhesive seaming method showing right side of completed seam.

10.6 UNUSUAL CONDITIONS

This section is written to give insight into conditions which go beyond the general description just presented.

- (a) High winds, or gusts of wind, are always problematic for liners. After deploying the geomembrane, the panels should be adequately ballasted, e.g., with sandbags. The actual seaming operation, however, may require the removal of some of the ballast leaving the windward edge vulnerable to wind uplift forces. If possible, proper orientation of the overlap might be helpful. Otherwise, additional labor may be required to only remove sandbags immediately in front of the seaming operation. The liner must be cleaned of any dirt and moisture left behind after sandbag removal. They are then to be replaced behind the completed seaming operation.

- (b) Patches are invariably necessary to make at locations where destructive test samples are removed or where seams are shown to fail nondestructive testing. These patches must extend a minimum of 15 cm (6 inches) beyond the outer limits of the area to be repaired. Since a seaming board cannot be used in these areas, additional care is necessary. Sometimes excess pieces of geomembrane material which are left in place, are positioned beneath the area to be seamed.
- (c) Details around sumps, pipes and other appurtenances are perhaps the most demanding locations in an entire facility to properly seam. Also due to their typical locations being at low points of the containment facility's design, these areas inherently operate under larger hydraulic heads. Should a defect from improper seaming occur in such a location leakage rates and its associated adverse impacts are heightened. Therefore, extreme care should be exercised in ensuring seam integrity in these often difficult to reach locations. The adhesive should be placed symmetrically on both liners to be joined which may be difficult for external and internal edges and particularly at corners. Hand and finger pressure is needed in tight locations.
- (d) This section was written for material temperatures that range between 0°C (32°F) and 50°C (122°F). This is the temperature range that is generally recognized as being acceptable for seaming without taking special precautions.

For sheet temperatures below 0°C (32°F), shielding, preheating, different chemical compounds and/or a slower seaming rate may be required. More frequent seam testing and precautions to prevent thawing subgrade (previously discussed) may have to be taken. Sharp, frozen subgrade should be avoided or perhaps a geotextile used to eliminate point pressure damage potential.

For sheet temperatures above 50°C (122°F), shielding and rate of seaming should be adjusted. More frequent destructive seam testing may have to be taken.

FIELD NOTES:

FIELD NOTES:



SECTION 11

EMERGING TECHNOLOGIES FOR GEOMEMBRANE SEAMING

Selected geomembrane sheet seaming methods which are not widely used at the present time are discussed in this section. These include ultrasonic seams, electrical conduction bonding and magnetic induction bonding methods.

The physical principles of each of these techniques are discussed, as well as their current degree of development and implementation. The potential advantages and disadvantages of the methods are also discussed.

11.1 ULTRASONIC SEAMS

Ultrasonic methods are used by various industries in a variety of ways. These include product cleaning, thickness gauging, nondestructive flaw detection, hardness testing, exotic machining, emulsification, sewing, biological cell disruption, bonding of quite dissimilar materials (as in the microelectronics area) and, of course, joining plastics. The technique is well advanced and fully implemented in areas other than geomembrane seaming.

In ultrasonic seaming of thermoplastics, an intense local vibration is induced at the material interface by means of a piezoelectric, or magnetostrictive, driven horn, see Figure 11.1. The exact mechanism of the bonding is not completely understood but it involves friction-driven melting (at least locally) of the plastic and subsequent solidification and bonding. Pressure is usually applied to the interface during the bond's formation. It is also suggested that the breaking of non-resin materials (e.g., oxides) at the interface may be inherent to the bonding process. The frequencies of vibration in ultrasonic welding are usually in the tens of kilohertz range. The weld time is typically very short; on the order of a few seconds.

Figure 11.2 is a schematic drawing of the ultrasonic seaming process for seaming of geomembrane sheets. The sheet material to be seamed is fed between the two rollers; between the sheets is located the ultrasonic horn. The horn vibrates longitudinally at approximately 40,000 Hz (cycles/sec) and works in the squeeze roller nip areas directly against the two surfaces to be joined. The vibrational peak-to-peak amplitude is about 0.038 mm (0.0015 in.). The vibrating action works with the frictional characteristics of the material to produce the heat for melting and bonding the geomembrane. Materials with higher frictional coefficients produce heat more rapidly. Knurled surfaces are usually incorporated into the working areas of the horn to better engage the material, to disrupt any surface contaminants, to concentrate the energy and to provide for mixing of the molten polymer just as the sheets are entering the squeeze portions of the rollers. The unit can seam thermoplastic

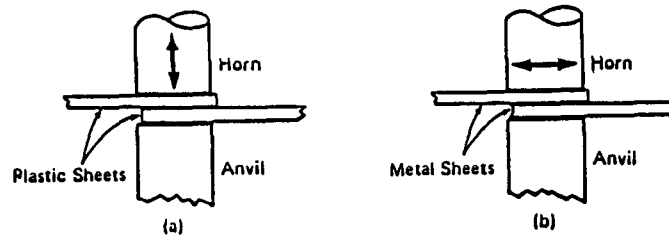

Figure 11.1. Schematic diagrams of ultrasonic welding of plastic (and metal) sheets.

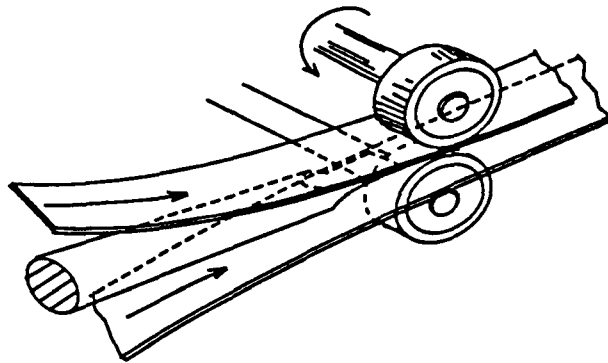

Figure 11.2. Schematic diagram of rollers, ultrasonic horn and geomembrane sheets in the ultrasonic seaming process. The method is called the "Ultrascaner" by the developers.

to 1.5 meters/min. (3-5 feet/minute). Shear and peel values of the completed seams are reported to be as good as with traditional seaming techniques.

11.2 ELECTRICAL CONDUCTION SEAMING

In the electrical conduction seaming technique for plastics, electric current is passed through wires embedded in (or placed between) the vicinity of the parts to be joined. The temperature of the wires rises via ohmic heating and the heat is transferred to the plastic which melts in the vicinity of the wires. Upon solidifying, the parts are joined. Pressure is usually applied, either physically, or indirectly by differences in thermal expansion of the parts. Both ac and dc currents have been used. Welding times are typically the same as those common in the geomembrane heat fusion techniques, for it is essentially a thermal technique. This particular seaming method is widely used in the natural gas plastic pipeline area and is usually called the "electro-fusion" technique. Figure 11.3 gives a schematic diagram of the electro-fusion process which indicates that certain properties are measured in real-time, and fed back to the control panel to readjust and optimize welding conditions.

Initial tests on this type of seaming of geomembranes were on a 1.5 mm (60 mils) HDPE geomembrane. Stainless steel wires were braided around a 0.6 cm (1/4 inch) diameter HDPE core. Figure 11.4 shows a sketch of the assembly. A force was applied normal to the sheets with the braided wire between. Electrical current (ac) of 5-10 amperes was passed through the wires. The wires heat due to ohmic effects and melt the core and the adjacent sheet material. The current was stopped after a prescribed time and the material subsequently solidified, thereby bonding the sheets together. Under the present experimental circumstances, maximum weld lengths of about 1 meter (3 feet) can be made with a single application of the current electrodes.

To date the electrical conduction technique has not been used to field seam geomembranes and is currently in an experimental stage.

11.3 MAGNETIC INDUCTION SEAMING

In electromagnetic induction seaming, a conductor and/or hysteretic material (in the form of wires, particles, strips, etc.) is placed at the interface to be joined. A non-contacting, induction coil containing high frequency electric current passes over the area to be seamed. The time-varying magnetic field caused by the current in the coil induces eddy currents and/or hysteresis loss in the embedded materials. Hence the area is heated, melts, solidifies and bonding takes place. Pressure is usually applied to the interface. Frequencies generally range from 3-7 MHz and 80-320 KHz, depending on the particular application. A wide variety of plastic assembly and sealing applications have been performed. The electromagnetic induction method has been mentioned briefly in the natural gas pipeline literature, but no details are available as to its use.

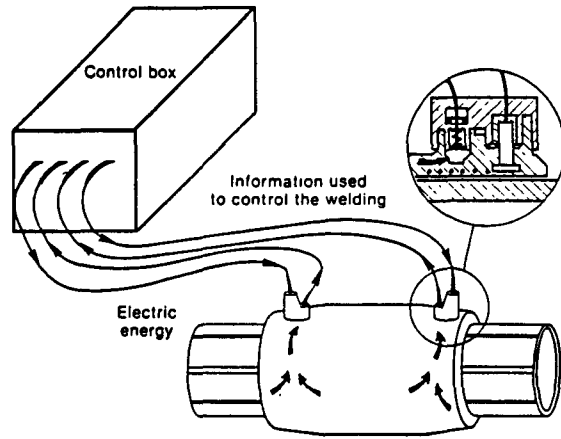

Figure 11.3. Schematic diagram of an electrofusion pipe coupling process.

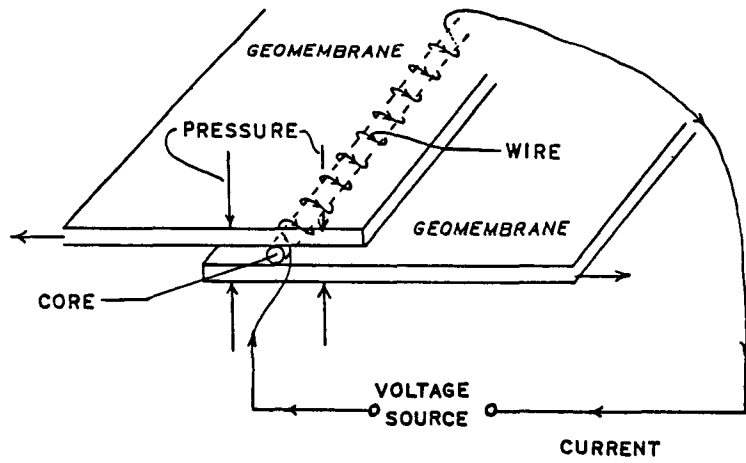

Figure 11.4. Schematic diagram of the electrical conduction method of joining geomembranes.

Figure 11.5 is a schematic diagram of the fabrication process of electromagnetic induction seaming for geomembranes. An HDPE sheet of 0.945 g/cm³ density and 1.5 mm (60 mils) thickness was used in the tests. The braided core, made by the same process as described for the electrical conduction method is placed between the two sheets and force is applied normal to the sheet. An electromagnetic coil carrying high frequency alternating current of about 200 KHz is passed directly over the braided core. No contact whatsoever is made between the electromagnetic coil and the sheet. The coil is about 0.6 cm (1/4 inch) to 1.2 cm (1/2 inch) above the top geomembrane sheet. Eddy currents are induced in the embedded braided wire by the time-varying magnetic field. This results in ohmic heating which melts the core and a certain amount of the adjacent sheet material. After the coil has passed, the eddy currents cease and the material solidifies and bonds the sheets together. Rates of about 0.3 m/min. (1.0 ft/min.) have been achieved. Preliminary results of mechanical testing of the seams give about 90% of sheet value for shear but are very poor in peel. By optimization of the welding parameters, this situation may improve.

To date the magnetic induction technique has not been used to field seam geomembranes and is currently in an experimental stage.

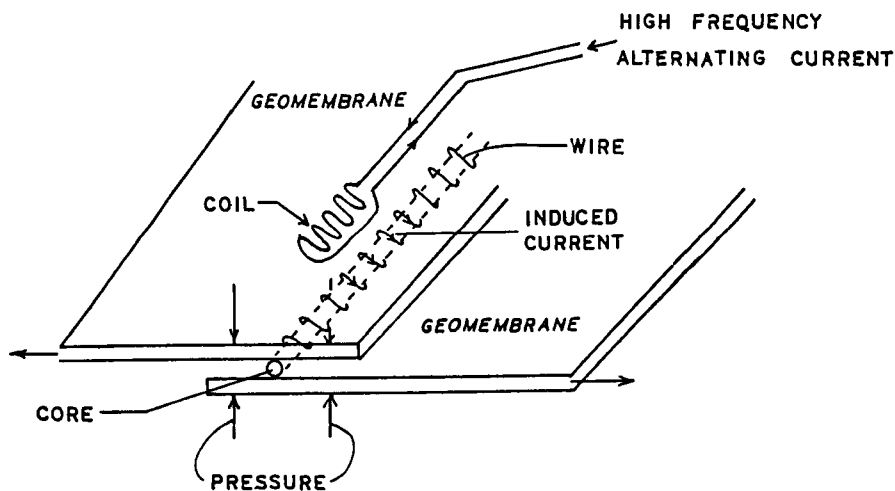

Figure 11.5. Schematic diagram of the magnetic induction method of joining geomembranes.

FIELD NOTES:



SECTION 12

REFERENCES

1. Frobel, R. K., "Methods of Constructing and Evaluating Geomembrane Seams," Proc. Conf. on Geomembranes, Denver, CO., 1984, IFAI, pp. 359-364.
2. Lord, A. E. Jr., Koerner, R. M. and Crawford, R. B., "Nondestructive Testing Techniques to Assess Geomembrane Seam Quality," Proc. Mgmt. of Uncontrolled Haz. Waste Sites, Washington, DC, 1986, HMCRI, pp. 272-276.
3. Overmann, L. K., "Nondestructive Seam Testing: CQC Perspectives," Proc. on the Seaming of Geosynthetics, Journal of Geotextiles and Geomembranes, Elsevier Appl. Sci. Pub. Ltd., Vol., No. 4-6, 1990, pp. 415-430.
4. Richardson, G. N., "Nondestructive Seam Testing: CQA Perspectives," Proc. on the Seaming of Geosynthetics, Journal of Geotextiles and Geomembrane, Elsevier Appl. Sci. Pub. Ltd., Vol. 9, No. 4-6, 1990, pp. 445-450.
5. Haxo, Henry E. Jr., and L. C. Kamp, "Destructive Testing of Geomembrane Seams: Shear and Peel Testing of Seam Strength," Proc. on the Seaming of Geosynthetics, Journal of Geotextiles and Geomembranes, Elsevier Appl. Sci. Pub. Ltd., Vol. 9, No. 4-6, 1990, pp. 369-396.
6. Peggs, Ian D., "Destructive Testing of Polyethylene Geomembrane Seams: Various Methods to Evaluate Seam Strength," Proc. on the Seaming of Geosynthetics, Journal of Geotextiles and Geomembranes, Elsevier Appl. Sci. Pub. Ltd., Vol. 9, No. 4-6, 1990, pp. 405-414.
7. Matrecon, Inc., "Lining of Waste Containment and Other Impoundment Facilities," EPA/600/2-88/052, NTIS PB89-129670, Sept. 1988.
8. U.S. EPA Technical Guidance Document, "Construction Quality Assurance for Hazardous Waste Land Disposal Facilities," EPA/530-SW-86-031, NTIS PB87-132825, Oct. 1986.
9. Haxo, H. E. Jr., "Quality Assurance of Geomembranes Used as Linings for Hazardous Waste Containment," Journal of Geotextiles and Geomembranes, Vol. 3, No. 4, 1986, pp. 225-248.

10. Apse, J. I., "Polyethylene Resins for Geomembrane Applications," Proc. on Aging and Durability of Geosynthetics, R. M. Koerner, Ed., Elsevier Appl. Sci. Pub. Ltd., 1989, pp. 159-176.
11. ASTM, Proposed Document for Task Committee D-4000 on Plastic Liners, June, 1989.
12. Koerner, R. M., Designing with Geosynthetics, 2nd Edition, Prentice Hall Publ. Co., Englewood Cliffs, NJ, 1990.
13. Koerner, G. R. and Bove, J. A., "Construction Quality Assurance of HDPE Geomembrane Installations," Proc. Geosynthetics '89, San Diego, CA., IFAI, pp. 70-83.
14. ASTM D 4439, "Terminology for Geosynthetics," American Society for Testing and Materials, Philadelphia, PA.

FIELD NOTES:

FIELD NOTES:



SECTION 13
GLOSSARY OF TERMS

Air Lance - A commonly used nondestructive test method performed with a stream of air forced through a nozzle at the end of a hollow metal tube to determine seam continuity and tightness of relatively thin, flexible geomembranes.

Adhesive - A chemical system used in the bonding of geomembranes. The adhesive residue results in an additional element in the seamed area. (Manufacturers and installers should be consulted for the various types of adhesives used with specific geomembranes.)

Anvil - In hot wedge seaming of geomembranes, the anvil is the wedge of metal above and below which the sheets to be joined must pass. The temperature controllers and thermocouples of most hot wedge devices are located within the anvil.

Bodied Chemical Fusion Agent - A chemical fluid containing a portion of the parent geomembrane that, after the application of pressure and after the passage of a certain amount of time, results in the chemical fusion of two essentially similar geomembrane sheets, leaving behind only that portion of the parent material. (Manufacturers and installers should be consulted for the various types of chemical fluids used with specific geomembranes in order to inform workers and inspectors.)

Buffing - An inaccurate term often used to describe the grinding of polyethylene geomembranes to remove surface oxides and waxes in preparation of extrusion seaming.

Chemical-Adhesive Fusion Agent - A chemical fluid that may or may not contain a portion of the parent geomembrane and an adhesive that, after the application of pressure and after passage of a certain amount of time, results in the chemical fusion of two geomembrane sheets, leaving behind an adhesive layer that is dissimilar from the parent liner material. (Manufacturers and installers should be consulted for the various types of chemical fluids used with specific geomembrane to inform workers and inspectors.)

Chemical Fusion - The chemically-induced reorganization in the polymeric structure of the surface of a polymer geomembrane that, after the application of pressure and the passage of a certain amount of time, results in the chemical fusion of two essentially similar geomembrane sheets being permanently joined together.

Chemical Fusion Agent - A chemical fluid that, after the application of the passage of a certain amount of time, results in the chemical fusion of two essentially similar geomembrane sheets without any other polymeric or adhesive additives. (Manufacturers and installers should be consulted for the various types of chemical fusion agents used with specific geomembranes to inform workers and inspectors.)

Chlorinated Polyethylene (CPE) - Family of polymers produced by the chemical reaction of chlorine with polyethylene. The resultant polymers presently contain 25-45% chlorine by weight and 0-25% crystallinity.

Chlorinated Polyethylene-Reinforced (CPE-R) - Sheets of CPE with an encapsulated fabric reinforcement layer, called a "scrim".

Chlorosulfonated Polyethylene (CSPE) - Family of polymers produced by the reaction of polyethylene with chlorine and sulphur dioxide. Present polymers contain 23.5 to 43% chlorine and 1.0 to 1.4% sulphur. A "low water absorption" grade is identified as significantly different from standard grades.

Chlorosulfonated Polyethylene-Reinforced (CSPE-R) - Sheets of CSPE with an encapsulated fabric reinforcement layer, called a "scrim".

Construction Quality Assurance (CQA) - A planned system of activities whose purpose is to provide an evaluation of the completed liner and initiate corrective action where necessary.

Construction Quality Control (CQC) - Actions that provide a means of monitoring and measuring the quality of the product as it is being installed.

Crystal Structure - The geometrical arrangement of the molecules that occupy the space lattice of the crystalline portion of a polymer.

Curing - The strength gain over time of a chemically fused, bodied chemically fused, or chemical adhesive geomembrane seam due primarily to evaporation of solvents or crosslinking of the organic phase of the mixture.

Curing Time - The time required for full curing as indicated by no further increase in strength over time.

Destructive Tests - Tests performed on geomembrane samples cut out of a field installation or test strip to verify specification performance requirements, e.g., shear and peel tests of geomembrane seams during which the specimens are destroyed.

Drive Rollers - Knurled or rubber rollers which grip the geomembrane sheets via applied pressure and propel the seaming device at a controlled rate of travel.

Dwell Time - The time required for a chemical fusion, bodied chemical fusion or adhesive seam to take its initial "tack", enabling the two opposing geomembranes to be joined together.

Environmental Stress Crack (ESC) - see also **Stress Crack** - External or internal stress propagation in a plastic caused by environmental conditions which are usually chemical or thermal in nature.

Ethylene Interpolymer Alloy (EIA)- A blend of ethylene vinyl acetate and polyvinyl chloride resulting in a thermoplastic elastomer.

Ethylene Interpolymer Alloy-Reinforced (EIA-R) - Sheets of EIA with an encapsulated fabric reinforcement layer.

Extrudate - The molten polymer which is emitted from an extruder during seaming using either extrusion fillet or extrusion flat methods. The polymer is initially in the form of a ribbon, rod, bead or pellets.

Extrusion Seams - A seam between two geomembrane sheets achieved by heat-extruding a polymer material between or over the overlap areas followed by the application of pressure.

Factory Seams - The seaming of geomembrane rolls together in a factory to make large panels to reduce the number of field seams.

Field Seams - The seaming of geomembrane rolls or panels together in the field making a continuous liner system.

Fishmouth - The uneven mating of two geomembranes to be joined wherein the upper sheet has excessive length that prevents it from being bonded flat to the lower sheet. The resultant opening is often referred to as a "fishmouth".

Flashing - The molten extrudate or sheet material which is extruded beyond the die edge or molten edge, also called "squeeze-out".

Flexible Member Liner (FML) - Synonymous term for geomembrane.

Flood Coating - The generous application of a bodied chemical compound, or chemical adhesive compound to protect exposed yarns in scrim reinforced geomembranes.

Geomembrane - An essentially impermeable membrane used as a solid or liquid barrier. Synonymous term for flexible membrane liner (FML).

Geotextile - Any permeable textile used with foundation, soil, rock, earth, or any other geotechnical engineering-related material as an integral part of a human-made project, structure, or system.

Grinding - The removal of oxide layers and waxes from the surface of a polyethylene sheet in preparation of extrusion fillet or extrusion flat seaming.

- Gun** - Synonymous term for hand held extrusion fillet device or hand held hot air device.
- High Density Polyethylene (HDPE)** - A polymer prepared by low-pressure polymerization of ethylene as the principal monomer and having the characteristics of ASTM D1348 Type III and IV polyethylene. Such polymer resins have density greater than or equal to 0.941 g/cc as noted in ASTM D1248.
- Hook Blade** - A shielded knife blade confined in such a way that the blade cuts upward or is drawn toward the person doing the cutting to avoid damage to underlying sheets.
- Horn** - The vibrating device used with ultrasonic seaming which vibrates at high frequency causing friction and a subsequent melting of the surfaces that it contacts.
- Initial Reaction Time** - Dwell time.
- Medium Density Polyethylene (MDPE)** - A polymer prepared by low-pressure polymerization of ethylene as the principal monomer and having the characteristics of ASTM D1348 Type II polyethylene. Such polymer resins have density less than 0.941 g/cc as noted in ASTM D1248.
- Mouse** - Synonymous term for hot wedge, or hot shoe, seaming device.
- Nondestructive Test** - A test method which does not require the removal of samples from, nor damage to, the installed liner system. The evaluation is done in an in-situ manner. The results do not indicate the seam's mechanical strength.
- Oxide Layer** - The reacting of atmospheric oxygen with the surface of the polymer sheet.
- Pinholes** - Very small imperfections in sheet or seamed geomembranes which may allow for escape of the contained liquid.
- Plasticizer** - A material, generally an organic liquid, incorporated in a plastic or rubber formulation to soften the resin polymer and improve flexibility, ductility and extensibility.
- Polyethylene (PE)** - A semicrystalline thermoplastic polymer made by polymerizing ethylene and other co-monomer(s).
- Polymer** - A carbon based organic chemical material formed by the chemical reaction of monomers having either the same or different chemical structures. Plastics, rubbers and textile fibers are all relatively high molecular weight polymers.

Polyvinyl Chloride (PVC) - A non-crystalline thermoplastic polymer composition prepared from polymerized vinyl monomer by blending with one or more low or non-volatile plasticizers made by polymerizing vinyl chlorine monomer.

Pressure Rollers - Rollers accompanying a seaming technique which apply pressure to the opposing geomembrane sheets to be joined. They closely follow the actual melting process and are self-contained within the seaming device.

Puckering - A heat related sign of localized strain caused by improper seaming using extrusion or fusion methods. It often occurs on the bottom of the lower geomembrane and in the shape of a shallow inverted "V".

Quality Assurance - See construction quality assurance.

Quality Control - See construction quality control.

Scrim Designation - The weight and number of yarns of fabric reinforcement per inch of length and width, e.g, a 10 X 10 scrim has 10 yarns per inch in both the machine and cross machine directions.

Scrim (or Fabric) Reinforcement - The fabric reinforcement layer used with some geomembranes for the purpose of increased strength and dimensional stability.

Sealant - A viscous chemical used to seal the exposed edges of scrim reinforced geomembranes. (Manufacturers and installers should be consulted for the various types of sealant used with specific geomembranes).

Seaming Boards - Smooth wooden planks placed beneath the area to be seamed to provide a uniform resistance to applied roller pressure in the fabrication of seams.

Shielded Blade - A knife within a housing which protects the blade from being used in an open fashion, i.e., a protected knife.

Squeeze-Out -See "flashing".

Solvent, Bodied Solvent and Solvent Adhesive - See Chemical Fusion, Bodied Chemical Fusion and Chemical Adhesive.

Stress Crack - ASTM D1693 - An external or internal rupture in a plastic caused by tensile stress less than its short-time mechanical strength.

Stress Crack - ASTM D883 - An external or internal crack in a plastic caused by tensile stresses less than its short-time mechanical strength.
Note: The development of such cracks is frequently accelerated by the environmental to which the plastic is exposed. The stresses which cause cracking may be present internally or externally or may be combinations of these stresses.

Tack - Stickiness.

Tensiometer - A device containing a set of opposing grips used to place a geomembrane seam in tension for evaluating its strength in shear or in peel.

Test Strips - Trial sections of seamed geomembranes used (1) to establish machine setting of temperature, pressure and travel rate for a specific geomembrane under a specific set of atmospheric conditions for machine-assisted seaming and (2) to establish methods and materials for chemical and chemical adhesive seams under a specific set of atmospheric conditions.

Test Welds - See "test strips".

Thermal Fusion - The temporary, thermally-induced reorganization in the polymeric make-up of the surface of a polymer geomembrane that, after the application of pressure and the passage of a certain amount of time, results in the two geomembranes being permanently joined together.

Thermoplastic Polymer - A polymer that can be heated to a softening point, shaped by pressure, and cooled to retain that shape. The process can be done repeatedly.

Thermoset Polymer - A polymer that can be heated to a softening point, shaped by pressure, and, if desired, removed from the hot mold without cooling. The process cannot be repeated since the polymer can not be resoftened by the application of heat.

Vacuum Box - A commonly used type of nondestructive test method which develops a vacuum in a localized region of an geomembrane seam in order to evaluate the seam's tightness and suitability.

Very Low Density Polyethylene (VLDPE) - A linear polymer of ethylene with other alpha-olefins with a density of 0.900 to 0.910.

Waxes - The low molecular weight components of some polyethylene compounds which migrate to the surface over time and must be removed by grinding (for HDPE) or be mixed into the melt zone using thermal seaming methods.

Wicking - The phenomenon of liquid transmission within the fabric yarns of reinforced geomembranes via capillary action.

FIELD NOTES:

FIELD NOTES:

