

**Technical Guidance Document:
QUALITY ASSURANCE AND QUALITY CONTROL
FOR WASTE CONTAINMENT FACILITIES**

by

**David E. Daniel
University of Texas at Austin
Department of Civil Engineering
Austin, Texas 78712**

and

**Robert M. Koerner
Geosynthetic Research Institute
West Wing, Rush Building No. 10
Philadelphia, Pennsylvania 19104**

Cooperative Agreement No. CR-815546-01-0

Project Officer

**David A. Carson
Risk Reduction Engineering Laboratory
Office of Research and Development
U.S. Environmental Protection Agency
Cincinnati, Ohio 45268**

**RISK REDUCTION ENGINEERING LABORATORY
OFFICE OF RESEARCH AND DEVELOPMENT
U.S. ENVIRONMENTAL PROTECTION AGENCY
CINCINNATI, OHIO 45268**

DISCLAIMER

The information in the document has been funded wholly or in part by the United States Environmental Protection Agency under assistance agreement number CR-815546-01-0. It has been subject to the Agency's peer and administrative review and has been approved for publication as a U.S. EPA document. Mention of trade names or commercial products does not constitute endorsement or recommendation for use.

This document contains numerous references to various procedures for performing tests as part of the process of quality control and quality assurance. Standards published by the American Society for Testing and Materials (ASTM) are referenced wherever possible because ASTM procedures represent consensus standards. Other testing procedures referenced in this document were generally developed by an individual or a small group of individuals and, therefore, do not represent consensus standards. The mention of non-consensus standards does not constitute their endorsement.

The reader is cautioned against using this document for the direct preparation of site specific quality assurance plans or related documents without giving proper consideration to the site- and project-specific requirements. To do so would ignore the educational context of the accompanying text, innovations made since the publication of the document, and the prevailing unique and site-specific aspects of all waste containment facilities.

FOREWORD

Today's rapidly developing and changing technologies and industrial products and practices frequently carry with them the increased generation of materials that, if improperly dealt with, can threaten both public health and the environment. The United States Environmental Protection Agency (U.S. EPA) is charged by Congress with protecting the Nation's land, air, and water resources. Under a mandate of national environmental laws, the Agency strives to formulate and implement actions leading to a compatible balance between human activities and the ability of natural systems to support and nurture life. These laws direct the U.S. EPA to perform research to define our environmental problems, measure the impacts, and search for solutions.

The Risk Reduction Engineering Laboratory is responsible for planning, implementing, and managing research, development, and demonstration programs to provide an authoritative, defensible engineering basis in support of the policies, programs, and regulations of the U.S. EPA with respect to drinking water, wastewater, pesticides, toxic substances, solid and hazardous wastes, and Superfund-related activities. This publication is one of the products of that research and provides a vital communication link between the researcher and the user community.

This document provides information needed to develop comprehensive quality assurance plans and to carry out quality control procedures at waste containment sites. It discusses quality assurance and quality control issues for compacted soil liners, soil drainage systems, geosynthetic drainage systems, vertical cutoff walls, ancillary materials, and appurtenances.

E. Timothy Oppelt
Director
Risk Reduction Engineering Laboratory

ABSTRACT

This Technical Guidance Document provides comprehensive guidance on procedures for quality assurance and quality control for waste containment facilities. The document includes a discussion of principles and concepts, compacted soil liners, soil drainage systems, geosynthetic drainage systems, vertical cutoff walls, ancillary materials, appurtenances, and other details. The guidance document outlines critical quality assurance (QA) and quality control (QC) issues for each major segment and recommends specific procedures, observations, tests, corrective actions, and record keeping requirements. For geosynthetics, QA and QC practices for both manufacturing and construction are suggested.

The main body of the text details recommended procedures for quality assurance and control. Appendices include a list of acronyms, glossary, and index. A companion document was under development by the American Society for Testing and Materials (ASTM) at the time of this writing that will contain all of the ASTM standards referenced in this guidance document as well as most, if not all, of the other test procedures that are referenced in this guidance document.

This report was submitted in fulfillment of CR-815546 by the University of Texas, Austin, under the sponsorship of the U.S. Environmental Protection Agency. This report covers a period from June 1991 to July 1993, and work was completed as of August 1993.

Table of Contents

| | <u>Page No.</u> |
|---|-----------------|
| Disclaimer | ii |
| Foreword | iii |
| Abstract | iv |
| List of Figures | xii |
| List of Tables | xix |
| Acknowledgments | xx |
| Chapter 1 Manufacturing Quality Assurance (MQA) and Construction Quality Assurance (CQA) Concepts and Overview | 1 |
| 1.1 Introduction | 1 |
| 1.1.1 Scope | 1 |
| 1.1.2 Definitions | 2 |
| 1.2 Responsibility and Authority | 3 |
| 1.3 Personnel Qualifications | 10 |
| 1.4 Written MQA/CQA Plan | 11 |
| 1.5 Documentation | 11 |
| 1.5.1 Daily Inspection Reports | 11 |
| 1.5.2 Daily Summary Reports | 11 |
| 1.5.3 Inspection and Testing Reports | 12 |
| 1.5.4 Problem Identification and Corrective Measures Reports | 13 |
| 1.5.5 Drawings of Record | 13 |
| 1.5.6 Final Documentation and Certification | 14 |
| 1.5.7 Document Control | 14 |
| 1.5.8 Storage of Records | 14 |
| 1.6 Meetings | 15 |
| 1.6.1 Pre-Bid Meeting | 15 |
| 1.6.2 Resolution Meeting | 15 |
| 1.6.3 Pre-construction Meeting | 16 |
| 1.6.4 Progress Meetings | 17 |
| 1.7 Sample Custody | 17 |
| 1.8 Weather | 17 |
| 1.9 Work Stoppages | 17 |
| 1.10 References | 18 |
| Chapter 2 Compacted Soil Liners | 19 |
| 2.1 Introduction and Background | 19 |
| 2.1.1 Types of Compacted Soil Liners | 19 |
| 2.1.1.1 Natural Mineral Materials | 19 |

| | | |
|-----------|---|----|
| 2.1.1.2 | Bentonite-Soil Blends | 19 |
| 2.1.1.3 | Other | 19 |
| 2.1.2 | Critical CQC and CQA Issues | 21 |
| 2.1.3 | Liner Requirements | 21 |
| 2.1.3.1 | Subgrade Preparation | 22 |
| 2.1.3.2 | Material Selection | 23 |
| 2.1.3.3 | Preprocessing | 23 |
| 2.1.3.4 | Placement, Remolding, and Compaction | 24 |
| 2.1.3.5 | Protection | 24 |
| 2.1.3.6 | Final Surface Preparation | 24 |
| 2.1.4 | Compaction Requirements | 24 |
| 2.1.4.1 | Compaction Curve | 24 |
| 2.1.4.2 | Compaction Tests | 26 |
| 2.1.4.3 | Percent Compaction | 27 |
| 2.1.4.4 | Estimating Optimum Water Content and Maximum Dry Unit Weight | 27 |
| 2.1.4.4.1 | Subjective Assessment | 28 |
| 2.1.4.4.2 | One-Point Compaction Test | 28 |
| 2.1.4.4.3 | Three-Point Compaction Test (ASTM D-5080) | 29 |
| 2.1.4.5 | Recommended Procedure for Developing Water Content-Density Specification | 30 |
| 2.1.5 | Test Pads | 34 |
| 2.2 | Critical Construction Variables that Affect Soil Liners | 35 |
| 2.2.1 | Properties of the Soil Material | 35 |
| 2.2.1.1 | Plasticity Characteristics | 35 |
| 2.2.1.2 | Percentage Fines | 37 |
| 2.2.1.3 | Percentage Gravel | 38 |
| 2.2.1.4 | Maximum Particle Size | 39 |
| 2.2.1.5 | Clay Content and Activity | 39 |
| 2.2.1.6 | Clod Size | 39 |
| 2.2.1.7 | Bentonite | 40 |
| 2.2.2 | Molding Water Content | 42 |
| 2.2.3 | Type of Compaction | 46 |
| 2.2.4 | Energy of Compaction | 48 |
| 2.2.5 | Bonding of Lifts | 52 |
| 2.2.6 | Protection Against Desiccation and Freezing | 53 |
| 2.3 | Field Measurement of Water Content and Dry Unit Weight | 53 |
| 2.3.1 | Water Content Measurement | 53 |

| | | |
|---------|---|----|
| 2.3.1.1 | Overnight Oven Drying (ASTM D-2216) | 53 |
| 2.3.1.2 | Microwave Oven Drying (ASTM D-4643) | 53 |
| 2.3.1.3 | Direct Heating (ASTM D-4959) | 54 |
| 2.3.1.4 | Calcium Carbide Gas Pressure Tester (ASTM D-4944) | 54 |
| 2.3.1.5 | Nuclear Method (ASTM D-3017) | 54 |
| 2.3.2 | Unit Weight | 56 |
| 2.3.2.1 | Sand Cone (ASTM D-1556) | 56 |
| 2.3.2.2 | Rubber Balloon (ASTM D-2167) | 57 |
| 2.3.2.3 | Drive Cylinder (ASTM D-2937) | 57 |
| 2.3.2.4 | Nuclear Method (ASTM D-2922) | 58 |
| 2.4 | Inspection of Borrow Sources Prior to Excavation | 61 |
| 2.4.1 | Sampling for Material Tests | 61 |
| 2.4.2 | Material Tests | 61 |
| 2.4.2.1 | Water Content | 62 |
| 2.4.2.2 | Atterberg Limits | 63 |
| 2.4.2.3 | Particle Size Distribution | 63 |
| 2.4.2.4 | Compaction Curve | 63 |
| 2.4.2.5 | Hydraulic Conductivity | 63 |
| 2.4.2.6 | Testing Frequency | 65 |
| 2.5 | Inspection during Excavation of Borrow Soil | 65 |
| 2.6 | Preprocessing of Materials | 67 |
| 2.6.1 | Water Content Adjustment | 67 |
| 2.6.2 | Removal of Oversize Particles | 68 |
| 2.6.3 | Pulverization of Clods | 68 |
| 2.6.4 | Homogenizing Soils | 68 |
| 2.6.5 | Bentonite | 68 |
| 2.6.5.1 | Pugmill Mixing | 70 |
| 2.6.5.2 | In-Place Mixing | 70 |
| 2.6.5.3 | Measuring Bentonite Content | 70 |
| 2.6.6 | Stockpiling Soils | 72 |
| 2.7 | Placement of Loose Lift of Soil | 72 |
| 2.7.1 | Surface Scarification | 73 |
| 2.7.2 | Material Tests and Visual Inspection | 73 |
| 2.7.2.1 | Material Tests | 73 |
| 2.7.2.2 | Visual Observations | 73 |
| 2.7.2.3 | Allowable Variations | 73 |
| 2.7.2.4 | Corrective Action | 75 |
| 2.7.3 | Placement and Control of Loose Lift Thickness | 75 |

| | | |
|----------|--|----|
| 2.8 | Remolding and Compaction of Soil | 76 |
| 2.8.1 | Compaction Equipment | 76 |
| 2.8.2 | Number of Passes | 77 |
| 2.8.3 | Water Content and Dry Unit Weight | 78 |
| 2.8.3.1 | Water Content and Unit Weight Tests | 78 |
| 2.8.3.2 | Sampling Patterns | 78 |
| 2.8.3.3 | Tests with Different Devices to Minimize Systematic Errors | 80 |
| 2.8.3.4 | Allowable Variations and Outliers | 80 |
| 2.8.3.5 | Corrective Action | 82 |
| 2.8.4 | Hydraulic Conductivity Tests on Undisturbed Samples | 82 |
| 2.8.4.1 | Sampling for Hydraulic Conductivity Testing | 83 |
| 2.8.4.2 | Hydraulic Conductivity Testing | 84 |
| 2.8.4.3 | Frequency of Testing | 84 |
| 2.8.4.4 | Outliers | 84 |
| 2.8.5 | Repair of Holes from Sampling and Testing | 85 |
| 2.8.6 | Final Lift Thickness | 85 |
| 2.8.7 | Pass/Fail Decision | 85 |
| 2.9 | Protection of Compacted Soil | 86 |
| 2.9.1 | Desiccation | 86 |
| 2.9.1.1 | Preventive Measures | 86 |
| 2.9.1.2 | Observations | 86 |
| 2.9.1.3 | Tests | 86 |
| 2.9.1.4 | Corrective Action | 86 |
| 2.9.2 | Freezing Temperatures | 86 |
| 2.9.2.1 | Compacting Frozen Soil | 86 |
| 2.9.2.2 | Protection After Freezing | 87 |
| 2.9.2.3 | Investigating Possible Frost Damage | 87 |
| 2.9.2.4 | Repair | 88 |
| 2.9.3 | Excess Surface Water | 88 |
| 2.10 | Test Pads | 88 |
| 2.10.1 | Purpose of Test Pads | 88 |
| 2.10.2 | Dimensions | 89 |
| 2.10.3 | Materials | 89 |
| 2.10.4 | Construction | 89 |
| 2.10.5 | Protection | 90 |
| 2.10.6 | Tests and Observations | 91 |
| 2.10.7 | In Situ Hydraulic Conductivity | 91 |
| 2.10.7.1 | Sealed Double-Ring Infiltrometer | 91 |

| | | |
|-----------|--|-----|
| 2.10.7.2 | Two-Stage Borehole Test | 93 |
| 2.10.7.3 | Other Field Tests | 95 |
| 2.10.7.4 | Laboratory Tests | 95 |
| 2.10.8 | Documentation | 95 |
| 2.11 | Final Approval | 95 |
| 2.12 | References | 95 |
| Chapter 3 | Geomembranes | 99 |
| 3.1 | Types of Geomembranes and Their Formulations | 99 |
| 3.1.1 | High Density Polyethylene (HDPE) | 100 |
| 3.1.1.1 | Resin | 100 |
| 3.1.1.2 | Carbon Black | 101 |
| 3.1.1.3 | Additives | 103 |
| 3.1.2 | Very Low Density Polyethylene (VLDPE) | 103 |
| 3.1.2.1 | Resin | 104 |
| 3.1.2.2 | Carbon Black | 104 |
| 3.1.2.3 | Additives | 105 |
| 3.1.3 | Other Extruded Geomembranes | 105 |
| 3.1.4 | Polyvinyl Chloride (PVC) | 106 |
| 3.1.4.1 | Resin | 106 |
| 3.1.4.2 | Plasticizer | 106 |
| 3.1.4.3 | Filler | 107 |
| 3.1.4.4 | Additives | 107 |
| 3.1.5 | Chlorosulfonated Polyethylene (CSPE-R) | 107 |
| 3.1.5.1 | Resin | 107 |
| 3.1.5.2 | Carbon Black | 109 |
| 3.1.5.3 | Fillers | 109 |
| 3.1.5.4 | Additives | 109 |
| 3.1.5.5 | Reinforcing Scrim | 109 |
| 3.1.6 | Other Calendered Geomembranes | 110 |
| 3.2 | Manufacturing | 110 |
| 3.2.1 | Blending, Compounding, Mixing and/or Masticating | 111 |
| 3.2.2 | Regrind, Reworked or Trim Reprocessed Material | 111 |
| 3.2.3 | High Density Polyethylene (HDPE) | 113 |
| 3.2.3.1 | Flat Die - Wide Sheet | 114 |
| 3.2.3.2 | Flat Die - Factory Seamed | 115 |
| 3.2.3.3 | Blown Film | 115 |

| | | |
|---------|---|-----|
| 3.2.3.4 | Textured Sheet | 117 |
| 3.2.4 | Very Low Density Polyethylene (VLDPE) | 120 |
| 3.2.4.1 | Flat Die - Wide Sheet | 120 |
| 3.2.4.2 | Flat Die - Factory Seamed | 120 |
| 3.2.4.3 | Blown Film | 121 |
| 3.2.4.4 | Textured Sheet | 121 |
| 3.2.5 | Coextrusion Processes | 123 |
| 3.2.6 | Polyvinyl Chloride (PVC) | 124 |
| 3.2.6.1 | Calendering | 124 |
| 3.2.6.2 | Panel Fabrication | 127 |
| 3.2.7 | Chlorosulfonated Polyethylene-Scrim Reinforced (CSPE-R) | 129 |
| 3.2.7.1 | Calendering | 129 |
| 3.2.7.2 | Panel Fabrication | 131 |
| 3.2.8 | Spread Coated Geomembranes | 131 |
| 3.3 | Handling | 132 |
| 3.3.1 | Packaging | 132 |
| 3.3.1.1 | Rolls | 132 |
| 3.3.1.2 | Accordion Folded | 133 |
| 3.3.2 | Shipment, Handling and Site Storage | 134 |
| 3.3.3 | Acceptance and Conformance Testing | 135 |
| 3.3.4 | Placement | 136 |
| 3.3.4.1 | Subgrade (Subbase) Conditions | 136 |
| 3.3.4.2 | Temperature Effects - Sticking/Cracking | 138 |
| 3.3.4.3 | Temperature Effects - Expansion/Contraction | 139 |
| 3.3.4.4 | Spotting | 140 |
| 3.3.4.5 | Wind Considerations | 140 |
| 3.4 | Seaming and Joining | 141 |
| 3.4.1 | Overview of Field Seaming Methods | 141 |
| 3.4.2 | Details of Field Seaming Methods | 145 |
| 3.4.3 | Test Strips and Trial Seams | 146 |
| 3.5 | Destructive Test Methods for Seams | 150 |
| 3.5.1 | Overview | 150 |
| 3.5.2 | Sampling Strategies | 151 |
| 3.5.2.1 | Fixed Increment Sampling | 151 |
| 3.5.2.2 | Randomly Selected Sampling | 152 |

| | | |
|-----------|---|-----|
| 3.5.2.3 | Other Sampling Strategies | 153 |
| 3.5.3 | Shear Testing of Geomembrane Seams | 153 |
| 3.5.4 | Peel Testing of Geomembrane Seams | 157 |
| 3.5.5 | General Specification Items | 160 |
| 3.6 | Nondestructive Test Methods for Seams | 161 |
| 3.6.1 | Overview | 161 |
| 3.6.2 | Currently Available Methods | 162 |
| 3.6.3 | Recommendations for Various Seam Types | 165 |
| 3.6.4 | General Specification Items | 165 |
| 3.7 | Protection and Backfilling | 167 |
| 3.7.1 | Soil Backfilling of Geomembranes | 167 |
| 3.7.2 | Geosynthetic Covering of Geomembranes | 170 |
| 3.7.3 | General Specification Items | 171 |
| 3.8 | References | 172 |
| Chapter 4 | Geosynthetic Clay Liners | 174 |
| 4.1 | Types and Composition of Geosynthetic Clay Liners | 174 |
| 4.2 | Manufacturing | 176 |
| 4.2.1 | Raw Materials | 176 |
| 4.2.2 | Manufacturing | 177 |
| 4.2.3 | Covering of the Rolls | 179 |
| 4.3 | Handling | 180 |
| 4.3.1 | Storage at the Manufacturing Facility | 180 |
| 4.3.2 | Shipment | 181 |
| 4.3.3 | Storage at the Site | 181 |
| 4.3.4 | Acceptance and Conformance Testing | 184 |
| 4.4 | Installation | 185 |
| 4.4.1 | Placement | 185 |
| 4.4.2 | Joining | 187 |
| 4.4.3 | Repairs | 187 |
| 4.5 | Backfilling or Covering | 188 |
| 4.6 | References | 189 |
| Chapter 5 | Soil Drainage Systems | 191 |
| 5.1 | Introduction and Background | 191 |
| 5.2 | Materials | 191 |
| 5.3 | Control of Materials | 195 |
| 5.4 | Location of Borrow Sources | 196 |

| | | |
|---|---|-----|
| 5.5 | Processing of Materials | 196 |
| 5.6 | Placement | 197 |
| 5.6.1 | Drainage Layers | 197 |
| 5.6.2 | Drainage Trenches | 197 |
| 5.7 | Compaction | 198 |
| 5.8 | Protection | 199 |
| 5.9 | References | 201 |
| Chapter 6 Geosynthetic Drainage Systems | | 202 |
| 6.1 | Overview | 202 |
| 6.2 | Geotextiles | 202 |
| 6.2.1 | Manufacturing of Geotextiles | 202 |
| 6.2.1.1 | Resins and Their Additives | 204 |
| 6.2.1.2 | Fiber Types | 206 |
| 6.2.1.3 | Geotextile Types | 207 |
| 6.2.1.4 | General Specification Items | 207 |
| 6.2.2 | Handling of Geotextiles | 210 |
| 6.2.2.1 | Protective Wrapping | 210 |
| 6.2.2.2 | Storage at Manufacturing Facility | 210 |
| 6.2.2.3 | Shipment | 212 |
| 6.2.2.4 | Storage at Field Site | 212 |
| 6.2.2.5 | Acceptance and Conformance Testing | 212 |
| 6.2.2.6 | Placement | 213 |
| 6.2.3 | Seaming | 214 |
| 6.2.3.1 | Seam Types and Procedures | 214 |
| 6.2.3.2 | Seam Tests | 217 |
| 6.2.3.3 | Repairs | 217 |
| 6.2.4 | Backfilling or Covering | 217 |
| 6.3 | Geonets and Geonet/Geotextile Geocomposites | 218 |
| 6.3.1 | Manufacturing of Geonets | 218 |
| 6.3.2 | Handling of Geonets | 221 |
| 6.3.2.1 | Packaging | 222 |
| 6.3.2.2 | Storage at Manufacturing Facility | 222 |
| 6.3.2.3 | Shipment | 222 |
| 6.3.2.4 | Storage at the Site | 222 |
| 6.3.2.5 | Acceptance and Conformance Testing | 222 |
| 6.3.2.6 | Placement | 223 |
| 6.3.3 | Joining of Geonets | 223 |

| | | |
|-----------|---|-----|
| 6.3.4 | Geonet/Geotextile Geocomposites | 225 |
| 6.4 | Other Types of Geocomposites | 226 |
| 6.4.1 | Manufacturing of Drainage Composites | 228 |
| 6.4.2 | Handling of Drainage Geocomposites | 231 |
| 6.4.2.1 | Packaging | 231 |
| 6.4.2.2 | Storage at Manufacturing Facility | 231 |
| 6.4.2.3 | Shipment | 231 |
| 6.4.2.4 | Storage at Field Site | 231 |
| 6.4.2.5 | Acceptance and Conformance Testing | 231 |
| 6.4.2.6 | Placement | 232 |
| 6.4.3 | Joining of Drainage Geocomposites | 232 |
| 6.4.4 | Covering | 233 |
| 6.5 | References | 233 |
| Chapter 7 | Vertical Cutoff Walls | 235 |
| 7.1 | Introduction | 235 |
| 7.2 | Types of Vertical Cutoff Walls | 237 |
| 7.2.1 | Sheet Pile Walls | 237 |
| 7.2.2 | Geomembrane Walls | 238 |
| 7.2.3 | Walls Constructed with Slurry Techniques | 239 |
| 7.3 | Construction of Slurry Trench Cutoff Walls | 241 |
| 7.3.1 | Mobilization | 241 |
| 7.3.2 | Site Preparation | 241 |
| 7.3.3 | Slurry Preparation and Properties | 241 |
| 7.3.4 | Excavation of Slurry Trench | 243 |
| 7.3.5 | Soil-Bentonite (SB) Backfill | 244 |
| 7.3.6 | Cement-Bentonite (CB) Cutoff Walls | 248 |
| 7.3.7 | Geomembrane in Slurry trench cutoff walls | 250 |
| 7.3.8 | Other Backfills | 250 |
| 7.3.9 | Caps | 251 |
| 7.4 | Other Types of Cutoff Walls | 251 |
| 7.5 | Specific CQA Requirements | 251 |
| 7.6 | Post Construction Tests for Continuity | 252 |
| 7.7 | References | 252 |
| Chapter 8 | Ancillary Materials, Appurtenances, and Other Details | 253 |
| 8.1 | Plastic Pipe (aka "Geopipe") | 253 |
| 8.1.1 | Polyvinyl Chloride (PVC) Pipe | 254 |
| 8.1.2 | High Density Polyethylene (HDPE) Smooth Wall Pipe | 256 |
| 8.1.3 | High Density Polyethylene (HDPE) Corrugated Pipe | 257 |

| | | |
|------------|--|-----|
| 8.1.4 | Handling of Plastic Pipe | 258 |
| 8.1.4.1 | Packaging | 259 |
| 8.1.4.2 | Storage at Manufacturing Facility | 259 |
| 8.1.4.3 | Shipment | 259 |
| 8.1.4.4 | Storage at Field Site | 259 |
| 8.1.5 | Conformance Testing and Acceptance | 259 |
| 8.1.6 | Placement | 261 |
| 8.2 | Sumps, Manholes and Risers | 261 |
| 8.3 | Liner System Penetrations | 264 |
| 8.4 | Anchor Trenches | 266 |
| 8.4.1 | Geomembranes | 266 |
| 8.4.2 | Other Geosynthetics | 268 |
| 8.5 | Access Ramps | 268 |
| 8.6 | Geosynthetic Reinforcement Materials | 270 |
| 8.6.1 | Geotextiles for Reinforcement | 272 |
| 8.6.2 | Geogrids | 273 |
| 8.7 | Geosynthetic Erosion Control Materials | 275 |
| 8.8 | Floating Geomembrane Covers for Surface Impoundments | 278 |
| 8.9 | References | 280 |
| Appendix A | List of Acroynms | 282 |
| Appendix B | Glossary | 285 |
| Appendix C | Index | 301 |

List of Figures

| Figure | Title | Page No. |
|--------|---|----------|
| 1.1 | Organizational Structure of MQA/CQA Inspection Activities | 4 |
| 2.1 | Examples of Compacted Soil Liners in Liner and Cover Systems | 20 |
| 2.2 | Tie-In of New Soil Liner to Existing Soil Liner | 22 |
| 2.3 | Compaction Curve | 25 |
| 2.4 | One-Point Compaction Test | 29 |
| 2.5 | Form of Water Content-Dry Unit Weight Specification Often Used in the Past | 30 |
| 2.6 | Recommended Procedure to Determine Acceptable Zone of Water Content/ Dry Unit Weight Values Based Upon Hydraulic Conductivity Considerations | 32 |
| 2.7 | Acceptable Zone of Water Content/Dry Unit Weights Determined by Superposing Hydraulic Conductivity and Shear Strength Data | 33 |
| 2.8 | Relationship between Hydraulic Conductivity and Plasticity Index | 36 |
| 2.9 | Relationship between Hydraulic Conductivity and Percent Fines | 37 |
| 2.10 | Relationship between Hydraulic Conductivity and Percentage Gravel Added to Two Clayey Soils | 38 |
| 2.11 | Relationship between Hydraulic Conductivity and Clay Content | 40 |
| 2.12 | Relationship between Clay Content and Plasticity Index | 41 |
| 2.13 | Effect of Addition of Bentonite to Hydraulic Conductivity of Compacted Silty Sand | 42 |
| 2.14 | Effect of Molding Water Content on Hydraulic Conductivity | 43 |
| 2.15 | Photograph of Highly Plastic Clay Compacted with Standard Proctor Effort at a Water Content of 16% (1% Dry of Optimum) | 44 |
| 2.16 | Photograph of Highly Plastic Clay Compacted with Standard Proctor Effort at a Water Content of 20% (3% Wet of Optimum) | 45 |
| 2.17 | Four Types of Laboratory Compaction Tests | 46 |
| 2.18 | Effect of Type of Compaction on Hydraulic Conductivity | 47 |
| 2.19 | Footed Rollers with Partly and Fully Penetrating Feet | 48 |
| 2.20 | Effect of Compactive Energy on Hydraulic Conductivity | 49 |
| 2.21 | Illustration of Why Dry Unit Weight Is a Poor Indicator of Hydraulic Conductivity for Soil Compacted Wet of Optimum | 50 |
| 2.22 | Line of Optimums | 51 |
| 2.23 | Flow Pathways Created by Poorly Bonded Lifts | 52 |
| 2.24 | Schematic Diagram of Nuclear Water Content - Density Device | 55 |
| 2.25 | Sand Cone Device | 56 |
| 2.26 | Schematic Diagram of Rubber Balloon Device | 58 |
| 2.27 | Schematic Diagram of Drive Ring | 59 |
| 2.28 | Measurement of Density with Nuclear Device by (a) Direct Transmission and (B) Backscattering | 60 |
| 2.29 | Recommended Procedure for Preparation of a Test Specimen Using Variable (But Documented) Compactive Energy for Each Trial | 64 |
| 2.30 | Schematic Diagram of Pugmill | 71 |
| 2.31 | Schematic Diagram of Soil Liner Test Pad | 90 |
| 2.32 | Schematic Diagram of Sealed Double Ring Infiltrometer (SDRI) | 91 |
| 2.33 | Three Procedures for Computing Hydraulic Gradient from Infiltration Test | 92 |
| 2.34 | Schematic Diagram of Two-Stage Borehole Test | 94 |
| 3.1 | HDPE Resin Pellets | 100 |
| 3.2 | Carbon Black in Particulate Form and as a Concentrate | 102 |

| | | |
|------|---|-----|
| 3.3 | CSPE Resin Pieces | 108 |
| 3.4 | Photographs of Materials to be Reprocessed | 112 |
| 3.5 | Cross-Section Diagram of a Horizontal Single-Screw Extruder for Polyethylene | 113 |
| 3.6 | Photograph of a Polyethylene Geomembrane Exiting from a Relatively Narrow Flat Horizontal Die | 114 |
| 3.7 | Photograph of Blown Film Manufacturing of Polyethylene Geomembranes and Sketch of Blown Film Manufacturing of Polyethylene Geomembranes | 116 |
| 3.8 | Various Methods Currently Used to Create Textured Surfaces on HDPE Geomembranes | 118 |
| 3.9 | Geomembrane Surface Temperature Differences Between Black and White Colors | 123 |
| 3.10 | Sketches of Various Process Mixers | 125 |
| 3.11 | Various Types of Four-Roll Calenders | 126 |
| 3.12 | Photographs of Calendered Rolls of Geomembranes After Manufacturing and Factory Fabrication of Rolls into Large Panels for Field Deployment | 128 |
| 3.13 | Multiple-Ply Scrim Reinforced Geomembrane | 130 |
| 3.14 | Rolls of Polyethylene Awaiting Shipment to a Job Site | 133 |
| 3.15 | Photograph of Truck Shipment of Geomembranes | 135 |
| 3.16 | Photographs Showing the Unrolling (Upper) and Unfolding (Lower) of Geomembranes | 137 |
| 3.17 | HDPE Geomembrane Showing Sun Induced Wrinkles | 139 |
| 3.18 | Wind Damage to Deployed Geomembrane | 141 |
| 3.19 | Various Methods Available to Fabricate Geomembrane Seams | 143 |
| 3.20 | Fabrication of a Geomembrane Test Strip | 147 |
| 3.21 | Photograph of a Field Tensiometer Performing a Geomembrane Seam Test | 148 |
| 3.22 | Test Strip Process Flow Chart | 149 |
| 3.23 | Completed Patch on a Geomembrane Seam Which had Previously Been Sampled for Destructive Tests | 152 |
| 3.24 | Shear Test of a Geomembrane Seam Evaluated in a CQC/CQA Laboratory Environment | 154 |
| 3.25 | Peel Test of a Geomembrane Seam Evaluated in a CQC/CQA Laboratory Environment | 158 |
| 3.26 | Advancing Primary Leachate Collection Gravel in "Fingers" Over the Deployed Geomembrane | 169 |
| 4.1 | Cross Section Sketches of Currently Available Geosynthetic Clay Liners (GCLs) | 175 |
| 4.2 | Schematic Diagrams of the Manufacture of Different Types of Geosynthetic Clay Liners (GCLs) | 178 |
| 4.3 | Indoor Factory Storage of Geosynthetic Clay Liners (GCLs) Waiting for Shipment to a Job Site | 180 |
| 4.4 | Fork Lift Equipped with a "Stinger" and GCL Rolls on a Flat-Bed Trailer | 182 |
| 4.5 | Photograph of Temporary Storage of GCLs in their Shipping Trailers and at Project Site | 183 |
| 4.6 | Field Deployment of a GCL on a Soil Subgrade and an Underlying Geosynthetic | 186 |
| 4.7 | Premature Hydration of a Geosynthetic Clay Liner Being Gathered and Discarded due to its Exposure to Rainfall Before Covering | 189 |
| 5.1 | Grain Size Distribution Curve | 192 |
| 5.2 | Filter Layer Used to Protect Drainage Layer from Plugging | 194 |

| | | |
|------|--|-----|
| 5.3 | Typical Design of a Drainage Trench | 198 |
| 5.4 | CQC and CQA Personnel Observing Placement of Select Waste on Drainage Layer | 200 |
| 6.1 | Cross Section of a Landfill Illustrating the Use of Different Geosynthetics Involved in Waste Containment Drainage Systems | 203 |
| 6.2 | Polyester Resin Chips and Carbon Black Concentrate Pellets Used for Geotextile Fiber Manufacturing | 205 |
| 6.3 | Types of Polymeric Fibers Used in the Construction of Different Types of Geotextiles | 206 |
| 6.4 | Three Major Types of Geotextiles | 208 |
| 6.5 | Photographs of Temporary Storage of Geotextiles | 211 |
| 6.6 | Various Types of Sewn Seams for Joining Geotextiles | 215 |
| 6.7 | Fabrication of a Geotextile Field Seam in a "Flat" or "Prayer" Seam Type | 216 |
| 6.8 | Typical Geonets Used in Waste Containment Facilities | 219 |
| 6.9 | Counter Rotating Die Technique for Manufacturing Drainage Geonets and Example of Laboratory Prototype | 220 |
| 6.10 | Geonets Being Temporarily Stored at the Job Site | 223 |
| 6.11 | Photograph of Geonet Joining by Using Plastic Fasteners | 224 |
| 6.12 | Various Types of Drainage Geocomposites | 227 |
| 6.13 | Vacuum Forming System for Fabrication of a Drainage Geocomposite | 229 |
| 6.14 | Photograph of Drainage Core Joining via Male-to-Female Interlock | 232 |
| 7.1 | Example of Vertical Cutoff Wall to Limit Flow of Ground Water into Excavation | 235 |
| 7.2 | Example of Vertical Cutoff Wall to Limit Flow of Ground Water through Buried Waste | 236 |
| 7.3 | Example of Vertical Cutoff Wall to Restrict Inward Migration of Ground Water | 236 |
| 7.4 | Example of Vertical Cutoff Wall to Limit Long-Term Contaminant Transport | 236 |
| 7.5 | Interlocking Steel Sheet Piles | 237 |
| 7.6 | Examples of Interlocks for Geomembrane Walls | 238 |
| 7.7 | Hydrostatic Pressure from Slurry Maintains Stable Walls of Trench | 239 |
| 7.8 | Diagram of Construction Process for Soil-Bentonite-Backfilled Slurry Trench Cutoff Wall | 240 |
| 7.9 | Construction of Dike to Raise Ground Surface for Construction of Slurry Trench | 242 |
| 7.10 | Backhoe for Excavating Slurry Trench | 244 |
| 7.11 | Clamshell for Excavating Slurry Trench | 245 |
| 7.12 | Mixing Backfill with Bentonite Slurry | 246 |
| 7.13 | Pushing Soil-Bentonite Backfill Into Slurry Trench with Dozer | 247 |
| 7.14 | Examples of Problems Produced by Improper Backfilling of Slurry Trench | 248 |
| 7.15 | Diaphragm-Wall Construction | 249 |
| 8.1 | Cross Section of a Possible Removal Pipe Scheme in a Primary Leachate Collection and Removal System | 253 |
| 8.2 | Plan View of a Possible Removal Pipe Scheme in a Primary Leachate Collection and Removal System | 254 |
| 8.3 | Photograph of PVC Pipe to be Used in a Landfill Leachate Collection System | 255 |
| 8.4 | Photograph of HDPE Smooth Wall Pipe Risers Used as Primary and Secondary Removal Systems from Sump Area to Pump and Monitoring Station | 256 |

| | | |
|------|---|-----|
| 8.5 | Photograph of HDPE Corrugated Pipe Being Coupled and After Installed | 258 |
| 8.6 | A Possible Buried Pipe Trench Cross Section Scheme Showing Soil Backfill Terminology and Approximate Dimensions | 262 |
| 8.7 | Various Possible Schemes for Leachate Removal | 263 |
| 8.8 | Pipe Penetrations through Various Types of Barrier Materials | 265 |
| 8.9 | Various Types of Geomembrane Anchors Trenches | 267 |
| 8.10 | Typical Access Ramp Geometry and Cross Section | 269 |
| 8.11 | Geogrid or Geotextile Reinforcement of (a) Cover Soil above Waste, (b) Leachate Collection Layer beneath Waste, and (c) Liner System Placed above Existing Waste ("Piggybacking") | 271 |
| 8.12 | Photographs of Geogrids Used as Soil (or Waste) Reinforcement Materials | 274 |
| 8.13 | Examples of Geosynthetic Erosion Control Systems | 277 |
| 8.14 | Surface Impoundments with Geomembrane Floating Covers along with Typical Details of the Support System and/or Anchor Trench and Batten Strips | 279 |

List of Tables

| <u>Table</u> | <u>Title</u> | <u>Page No.</u> |
|--------------|---|-----------------|
| 1.1 | Recommended Implementation Program for Construction Quality Control (CQC) for Geosynthetics (Beginning January 1, 1993) | 8 |
| 1.2 | Recommended Implementation Program for Construction Quality Assurance (CQA) for Geosynthetics (Beginning January 1, 1993) | 9 |
| 1.3 | Recommended Personnel Qualifications | 10 |
| 2.1 | Compaction Test Details | 26 |
| 2.2 | Materials Tests | 62 |
| 2.3 | Recommended Minimum Testing Frequencies for Investigation of Borrow Source | 65 |
| 2.4 | Criteria for Describing Dry Strength (ASTM D-2488) | 66 |
| 2.5 | Criteria for Describing Plasticity (ASTM D-2488) | 67 |
| 2.6 | Recommended Tests on Bentonite to Determine Bentonite Quality and Gradation | 70 |
| 2.7 | Recommended Tests to Verify Bentonite Content | 72 |
| 2.8 | Recommended Materials Tests for Soil Liner Materials Sampled after Placement in a Loose Lift (Just Before Compaction) | 74 |
| 2.9 | Recommended Maximum Percentage of Failing Material Tests | 75 |
| 2.10 | Recommended Tests and Observations on Compacted Soil | 79 |
| 2.11 | Recommended Maximum Percentage of Failing Compaction Tests | 82 |
| 3.1 | Types of Commonly Used Geomembranes and Their Approximate Weight Percentage Formulations | 99 |
| 3.2 | Fundamental Methods of Joining Polymeric Geomembranes | 142 |
| 3.3 | Possible Field Seaming Methods for Various Geomembranes Listed in this Manual | 145 |
| 3.4 | Recommended Test Method Details for Geomembrane Seams in Shear and in Peel and for Unseamed Sheet | 155 |
| 3.5 | Nondestructive Geomembrane Seam Testing Methods | 163 |
| 3.6 | Applicability Of Various Nondestructive Test Methods To Different Seam Types And Geomembrane Types | 166 |
| 3.7 | Critical Cone Heights For Selected Geomembranes In Simulated Laboratory Puncture Studies | 167 |
| 3.8 | Coefficients Of Thermal Expansion/Contraction Of Various Nonreinforced Geomembrane Polymers | 170 |
| 5.1 | Effect of Fines on Hydraulic Conductivity of a Washed Filter Aggregate | 193 |
| 5.2 | Recommended Tests and Testing Frequencies for Drainage Material | 196 |
| 6.1 | Compounds Used in The Manufacture of Geotextiles (Values Are Percentages Based on Weight) | 204 |

Acknowledgments

The authors gratefully acknowledge the following individuals and organizations who provided many of the photographs included in this report: Stephen T. Butchko of Tensar Environmental Systems, Inc., Richard W. Carriker of James Clem Corporation, Steven R. Day of Geo-Con, Inc., Anthony E. Eith of RUST Environmental and Infrastructure, Inc., Vito Galante of Waste Management of North America, Inc., Gary Kolbasuk of National Seal Co., David C. Lauwers of Occidental Chemical Corp., David L. Snyder of Webtec, Edward Staff, Jr., of Staff Industries, Inc., Fred Struve of Gundle Lining Systems, Inc., Michael T. Taylor of JPS Elastomerics Corp., and Dennis B. Wedding of Hoechst Celanese Corp.

The authors wish to express their sincere appreciation to the following individuals, who reviewed and critiqued an earlier version of this manuscript: Craig H. Benson, Gordon P. Boutwell, Mark Cadwallader, Craig R. Calabria, James G. Collin, Jose D. Constantino, Steven R. Day, Robert Denis, Richard H. Dickinson, Thomas N. Dobras, Lee Embrey, Jeffrey C. Evans, Richard A. Goodrum, Dave Guram, Janice Hall, Bill Hawkins, Georg Heerten, William A. Hoffman III, Ted Koerner, David C. Lauwers, Larry D. Lydick, Lance Mabry, Stephen F. Maher, William C. Neal, Leo Overmann, Ian Peggs, Gregory N. Richardson, Charles Rivette, Mark D. Sieracke, Edward C. Staff, James Stenborg, Frank Taylor, Stephen J. Trautwein, James F. Urek, Luke van't Hoog, Mark H. Wayne, Felon R. Wilson, and John P. Workman. The authors also thank Joseph A. Dieltz who, through the Industrial Fabrics Association International, provided assistance in obtaining reviews of an earlier draft of this document.

The authors also gratefully acknowledge the many individuals, too numerous to name here, who over the years have shared their experiences and recommendations concerning quality assurance and quality control with the authors. The member organizations of the Geosynthetic Research Institute are thanked for support of this effort. Finally, the assistance of and input by Mr. Robert E. Landreth with the U.S. EPA is gratefully acknowledged.

Chapter 1

Manufacturing Quality Assurance (MQA) and Construction Quality Assurance (CQA) Concepts and Overview

1.1 Introduction

As a prelude to description of the detailed components of a waste containment facility, some introductory comments are felt to be necessary. These comments are meant to clearly define the role of the various parties associated with the manufacture, installation and inspection of all components of a total liner and/or closure system for landfills, surface impoundments and waste piles.

1.1.1 Scope

Construction quality assurance (CQA) and construction quality control (CQC) are widely recognized as critically important factors in overall quality management for waste containment facilities. The best of designs and regulatory requirements will not necessarily translate to waste containment facilities that are protective of human health and the environment unless the waste containment and closure facilities are properly constructed. Additionally, for geosynthetic materials, manufacturing quality assurance (MQA) and manufacturing quality control (MQC) of the manufactured product is equally important. Geosynthetics refer to factory fabricated polymeric materials like geomembranes, geotextiles, geonets, geogrids, geosynthetic clay liners, etc.

The purpose of this document is to provide detailed guidance for proper MQA and CQA procedures for waste containment facilities. (The document also is applicable to MQC and CQC programs on the part of the manufacturer and contractor). Although facility designs are different, MQA and CQA procedures are the same. In this document, no distinction is made concerning the type of waste to be contained (e.g., hazardous or nonhazardous waste) because the MQA and CQA procedures needed to inspect quality lining systems, fluid collection and removal systems, and final cover systems are the same regardless of the waste type. This technical guidance document has been written to apply to all types of waste disposal facilities, including new hazardous waste landfills and impoundments, new municipal solid waste landfills, nonhazardous waste liquid impoundments, and final covers for new facilities and site remediation projects.

This document is intended to aid those who are preparing MQA/CQA plans, reviewing MQA/CQA plans, performing MQA/CQA observations and tests, and reviewing field MQC/CQC and MQA/CQA procedures. Permitting agencies may use this document as a technical resource to aid in the review of site-specific MQA/CQA plans and to help in identification of any deficiencies in the MQA/CQA plan. Owner/operators and their MQA/CQA consultants may consult this document for guidance on the plan, the process, and the final certification report. Field inspectors may use this document and the references herein as a guide to field MQA/CQA procedures. Geosynthetic manufacturers may use the document to help in establishing appropriate MQC procedures and as a technical resource to explain the reasoning behind MQA procedures. Construction personnel may use this document to help in establishing appropriate CQC procedures and as a technical resource to explain the reasoning behind CQA procedures.

This technical guidance document is intended to update and expand EPA's Technical Guidance Document, "Construction Quality Assurance for Hazardous Waste Land Disposal

Facilities,” (EPA, 1986). The scope of this document includes all natural and geosynthetic components that might normally be used in waste containment facilities, e.g., in liner systems, fluid collection and removal systems, and cover systems.

This document draws heavily upon information presented in three EPA Technical Guidance Documents: “Design, Construction, and Evaluation of Clay Liners for Waste Management Facilities” (EPA, 1988a), “Lining of Waste Containment and Other Impoundment Facilities” (1988b), and “Inspection Techniques for the Fabrication of Geomembrane Field Seams” (EPA, 1991a). In addition, general technical backup information concerning many of the principles involved in construction of liner and cover systems for waste containment facilities is provided in two additional EPA documents: “Requirements for Hazardous Waste Landfill Design, Construction, and Closure” (EPA, 1989) and “Design and Construction of RCRA/CERCLA Final Covers” (EPA, 1991b). Additionally, there are numerous books and technical papers in the open literature which form a large data base from which information and reference will be drawn in the appropriate sections.

1.1.2 Definitions

It is critical to define and understand the differences between MQC and MQA and between CQC and CQA and to counterpoint where the different activities contrast and/or complement one another. The following definitions are made.

- *Manufacturing Quality Control (MQC)*: A planned system of inspections that is used to directly monitor and control the manufacture of a material which is factory originated. MQC is normally performed by the manufacturer of geosynthetic materials and is necessary to ensure minimum (or maximum) specified values in the manufactured product. MQC refers to measures taken by the manufacturer to determine compliance with the requirements for materials and workmanship as stated in certification documents and contract plans.
- *Manufacturing Quality Assurance (MQA)*: A planned system of activities that provides assurance that the materials were constructed as specified in the certification documents and contract plans. MQA includes manufacturing facility inspections, verifications, audits and evaluation of the raw materials and geosynthetic products to assess the quality of the manufactured materials. MQA refers to measures taken by the MQA organization to determine if the manufacturer is in compliance with the product certification and contract plans for a project.
- *Construction Quality Control (CQC)*: A planned system of inspections that is used to directly monitor and control the quality of a construction project (EPA, 1986). Construction quality control is normally performed by the geosynthetics installer, or for natural soil materials by the earthwork contractor, and is necessary to achieve quality in the constructed or installed system. Construction quality control (CQC) refers to measures taken by the installer or contractor to determine compliance with the requirements for materials and workmanship as stated in the plans and specifications for the project.
- *Construction Quality Assurance (CQA)*: A planned system of activities that provides the owner and permitting agency assurance that the facility was constructed as specified in the design (EPA, 1986). Construction quality assurance includes inspections, verifications, audits, and evaluations of materials and workmanship necessary to determine and document the quality of the constructed facility. Construction quality

assurance (CQA) refers to measures taken by the CQA organization to assess if the installer or contractor is in compliance with the plans and specifications for a project.

MQA and CQA are performed independently from MQC and CQC. Although MQA/CQA and MQC/CQC are separate activities, they have similar objectives and, in a smoothly running construction project, the processes will complement one another. Conversely, an effective MQA/CQA program can lead to identification of deficiencies in the MQC/CQC process, but a MQA/CQA program by itself (in complete absence of a MQC/CQC program) is unlikely to lead to acceptable quality management. Quality is best ensured with effective MQC/CQC and MQA/CQA programs. See Fig. 1.1 for the usual interaction of the various elements in a total inspection program.

1.2 Responsibility and Authority

Many individuals are involved directly or indirectly in MQC/CQC and MQA/CQA activities. The individuals, their affiliation, and their responsibilities and authority are discussed below.

The principal organizations and individuals involved in designing, permitting, constructing, and inspecting a waste containment facility are:

- *Permitting Agency.* The permitting agency is often a state regulatory agency but may include local or regional agencies and/or the federal U. S. Environmental Protection Agency (EPA). Other federal agencies, such as the U.S. Army Corps of Engineers, the U.S. Bureau of Reclamation, the U.S. Bureau of Mines, etc., or their regional or state affiliates are sometimes also involved. It is the responsibility of the permitting agency to review the owner/operator's permit application, including the site-specific MQA/CQA plan, for compliance with the agency's regulations and to make a decision to issue or deny a permit based on this review. The permitting agency also has the responsibility to review all MQA/CQA documentation during or after construction of a facility, possibly including visits to the manufacturing facility and construction site to observe the MQC/CQC and MQA/CQA practices, to confirm that the approved MQA/CQA plan was followed and that the facility was constructed as specified in the design.
- *Owner/Operator.* This is the organization that will own and operate the disposal unit. The owner/operator is responsible for the design, construction, and operation of the waste disposal unit. This responsibility includes complying with the requirements of the permitting agency, the submission of MQA/CQA documentation, and assuring the permitting agency that the facility was constructed as specified in the construction plans and specifications and as approved by the permitting agency. The owner/operator has the authority to select and dismiss organizations charged with design, construction, and MQA/CQA. If the owner and operator of a facility are different organizations, the owner is ultimately responsible for these activities. Often the owner/operator, or owner, will be a municipality rather than a private corporation. The interaction of a state office regulating another state or local organization should have absolutely no impact on procedures, intensity of effort and ultimate decisions of the MQA/CQA or MQC/CQC process as described herein.

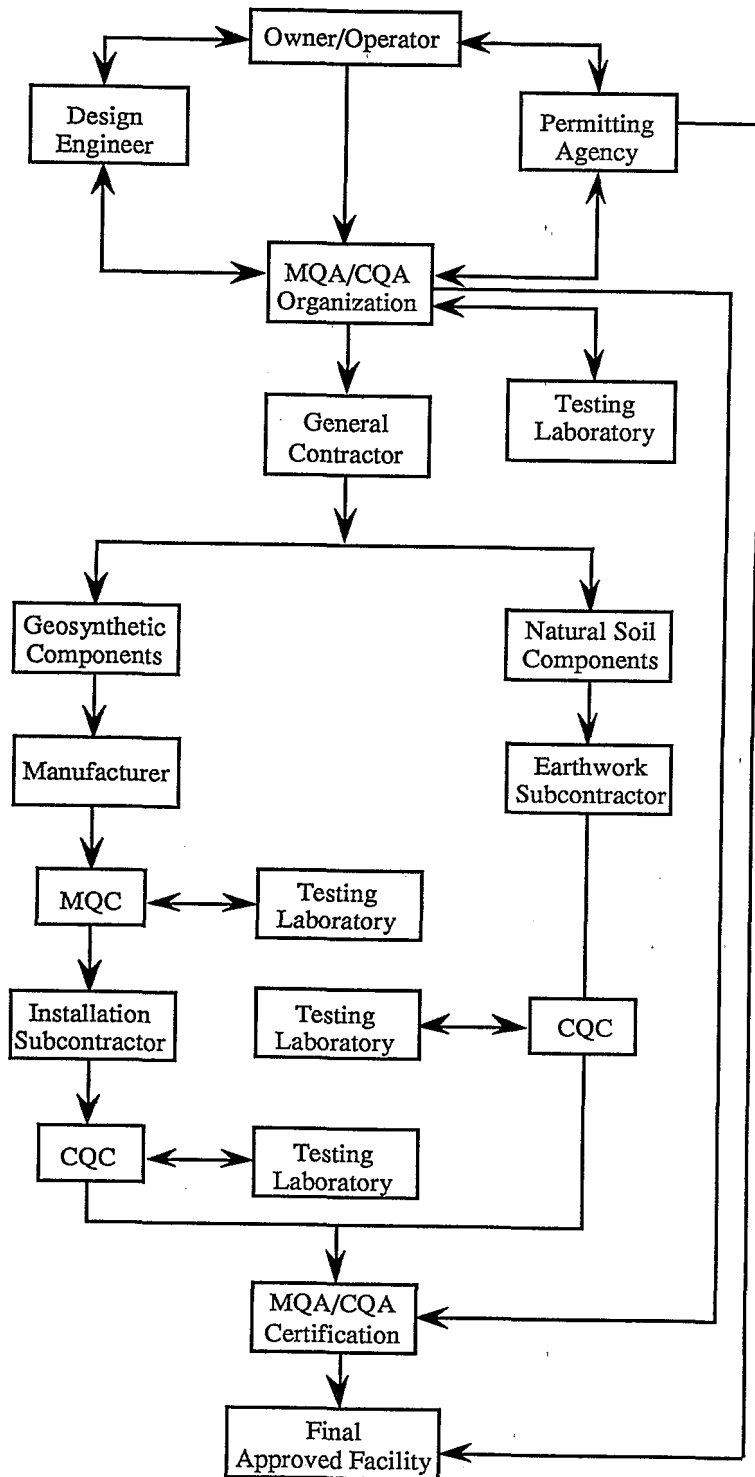

Figure 1.1 - Organizational Structure of MQA/CQA Inspection Activities

- *Owner's Representative.* The owner/operator usually has an official representative who is responsible for coordinating schedules, meetings, and field activities. This responsibility includes communications to other members in the owner/operator's organization, owner's representative, permitting agency, material suppliers, general contractor, specialty subcontractors or installers, and MQA/CQA engineer.
- *Design Engineer.* The design engineer's primary responsibility is to design a waste containment facility that fulfills the operational requirements of the owner/operator, complies with accepted design practices for waste containment facilities, and meets or exceeds the minimum requirements of the permitting agency. The design engineer may be an employee of the owner/operator or a design consultant hired by the owner/operator. The design engineer may be requested to change some aspects of the design if unexpected conditions are encountered during construction (e.g., a change in site conditions, unanticipated logistical problems during construction, or lack of availability of certain materials). Because design changes during construction are not uncommon, the design engineer is often involved in the MQA/CQA process. The plans and specifications referred to in this manual will generally be the product of the Design Engineer. They are a major and essential part of the permit application process and the subsequently constructed facility.
- *Manufacturer.* Many components, including all geosynthetics, of a waste containment facility are manufactured materials. The manufacturer is responsible for the manufacture of its materials and for quality control during manufacture, i.e., MQC. The minimum or maximum (when appropriate) characteristics of acceptable materials should be specified in the permit application. The manufacturer is responsible for certifying that its materials conform to those specifications and any more stringent requirements or specifications included in the contract of sale to the owner/operator or its agent. The quality control steps taken by a manufacturer are critical to overall quality management in construction of waste containment facilities. Such activities often take the form of process quality control, computer-aided quality control and the like. All efforts at producing better quality materials are highly encouraged. If requested, the manufacturer should provide information to the owner/operator, permitting agency, design engineer, fabricator, installer, or MQA engineer that describes the quality control (MQC) steps that are taken during the manufacturing of the product. In addition, the manufacturer should be willing to allow the owner/operator, permitting agency, design engineer, fabricator, installer, and MQA engineer to observe the manufacturing process and quality control procedures if they so desire. Such visits should be able to be made on an announced or unannounced basis. However, such visits might be coordinated with the manufacturer to assure that the appropriate people are present to conduct the tour and that the proper geosynthetic is scheduled for that date so as to obtain the most information from the visit. The manufacturer should have a designated individual who is in charge of the MQC program and to whom questions can be directed and/or through whom visits can be arranged. Random samples of materials should be able to be taken for subsequent analysis and/or archiving. However, the manufacturer should retain the right to insist that any proprietary information concerning the manufacturing of a product be held confidential. Signed agreements of confidentiality are at the option of the manufacturer. The owner/operator, permitting agency, design engineer, fabricator, installer, or MQA engineer may request that they be allowed to observe the manufacture and quality control of some or all of the raw materials and final product to be utilized on a particular job; the manufacturer should be willing to accommodate such requests. Note that these same comments apply to marketing organizations which represent a manufactured product made by others, as well as the manufacturing organization itself.

- Fabricator.*** Some materials are fabricated from manufactured components. For example, certain geomembranes are fabricated by seaming together smaller, manufactured geomembrane sheets at the fabricator's facility. The minimum characteristics of acceptable fabricated materials are specified in the permit application. The fabricator is responsible for certifying that its materials conform to those specifications and any more stringent requirements or specifications included in the fabrication contract with the owner/operator or its agent. The quality control steps taken by a fabricator are critical to overall quality in construction of waste containment facilities. If requested, the fabricator should provide information to the owner/operator, permitting agency, design engineer, installer, or MQA engineer that describes the quality control steps that are taken during the fabrication of the product. In addition, the fabricator should be willing to allow the owner/operator, permitting agency, design engineer, installer, or MQA engineer to observe the fabrication process and quality control procedures if they so desire. Such visits may be made on an announced or unannounced basis. However, such visits might be coordinated with the fabricator to assure that the appropriate people are present to conduct the tour and that the proper geosynthetic is scheduled for that date so as to obtain the most information from the visit. Random samples of materials should be able to be taken for subsequent analysis and/or archiving. However, the fabricator should retain the right to insist that any proprietary information concerning the fabrication of a product be held confidential. Signed agreements of confidentiality are at the option of the fabricator. The owner/operator, permitting agency, design engineer, or MQA engineer may request that they be allowed to observe the fabrication process and quality control of some or all fabricated materials to be utilized on a particular job; the fabricator should be willing to accommodate such a requests.
- General Contractor.*** The general contractor has overall responsibility for construction of a waste containment facility and for CQC during construction. The general contractor arranges for purchase of materials that meet specifications, enters into a contract with one or more fabricators (if fabricated materials are needed) to supply those materials, contracts with an installer (if separate from the general contractor's organization), and has overall control over the construction operations, including scheduling and CQC. The general contractor has the primary responsibility for ensuring that a facility is constructed in accord with the plans and specifications that have been developed by the design engineer and approved by the permitting agency. The general contractor is also responsible for informing the owner/operator and the MQA/CQA engineer of the scheduling and occurrence of all construction activities. Occasionally, a waste containment facility may be constructed without a general contractor. For example, an owner/operator may arrange for all the necessary material, fabrication, and installation contracts. In such cases, the owner/operator's representative will serve the same function as the general contractor.
- Installation Contractor.*** Manufactured products (such as geosynthetics) are placed and installed in the field by an installation contractor who is the general contractor, a subcontractor to the general contractor, or is a specialty contractor hired directly by the owner/operator. The installer's personnel may be employees of the owner/operator, manufacturer, or fabricator, or they may work for an independent installation company hired by the general contractor or by the owner/operator directly. The installer is responsible for handling, storage, placement, and installation of manufactured and/or fabricated materials. The installer should have a CQC plan to detail the proper manner that materials are handled, stored, placed, and installed. The installer is also responsible for informing the owner/operator and the MQA/CQA engineer of the scheduling and

occurrence of all geosynthetic construction activities.

- *Earthwork Contractor.* The earthwork contractor is responsible for grading the site to elevations and grades shown on the plans and for constructing earthen components of the waste containment facility, e.g., compacted clay liners and granular drainage layers according to the specifications. The earthwork contractor may be hired by the general contractor or if the owner/operator serves as the general contractor, by the owner/operator directly. In some cases, the general contractor's personnel may serve as the earthwork contractor. The earthwork contractor is responsible not only for grading the site to proper elevations but also for obtaining suitable earthen materials, transport and storage of those materials, preprocessing of materials (if necessary), placement and compaction of materials, and protection of materials during and (in some cases) after placement. If a test pad is required, the earthwork contractor is usually responsible for construction of the test pad. It is highly suggested that the same earthwork contractor that constructs the test fill also construct the waste containment facility compacted clay liner so that the experience gained from the test fill process will not be lost. Earthwork functions must be carried out in accord with plans and specifications approved by the permitting agency. The earthwork contractor should have a CQC plan (or agree to one written by others) and is responsible for CQC operations aimed at controlling materials and placement of those materials to conform with project specifications. The earthwork contractor is also responsible for informing the owner/operator and the CQA engineer of the scheduling and occurrence of all earthwork construction activities.
- *CQC Personnel.* Construction quality control personnel are individuals who work for the general contractor, installation contractor, or earthwork contractor and whose job it is to ensure that construction is taking place in accord with the plans and specifications approved by the permitting agency. In some cases, CQC personnel, perhaps even a separate company, may also be part of the installation or construction crews. In other cases, supervisory personnel provide CQC or, for large projects, separate CQC personnel, perhaps even a separate company, may be utilized. It is recommended that a certain portion of the CQC staff should be certified* as per the implementation schedule of Table 1.1. The examinations have been available as of October, 1992.
- *MQA/CQA Engineer.* The MQA/CQA engineer has overall responsibility for manufacturing quality assurance and construction quality assurance. The engineer is usually an individual experienced in a variety of activities although particular specialists in soil placement, polymeric materials and geosynthetic placement will invariably be involved in a project. The MQA/CQA engineer is responsible for reviewing the MQA/CQA plan as well as general plans and specifications for the project so that the MQA/CQA plan can be implemented with no contradictions or unresolved discrepancies. Other responsibilities of the MQA/CQA engineer include education of inspection personnel on MQA/CQA requirements and procedures and special steps that are needed on a particular project, scheduling and coordinating of MQA/CQA inspection activities, ensuring that proper procedures are followed, ensuring that testing laboratories are conforming to MQA/CQA requirements and procedures, ensuring that sample custody procedures are followed, confirming that test data are accurately reported and that test data are maintained for later reporting, and preparation of periodic reports. The most important duty of the MQA/CQA engineer is overall responsibility for confirming that the facility was constructed in accord with plans and specifications approved by the

* A certification program is available from the National Institute for Certification of Engineering Technologies (NICET); 1420 King Street; Alexandria, Virginia 22314 (phone: 703-684-2835)

permitting agency. In the event of nonconformance with the project specifications or CQA Plan, the MQA/CQA engineer should notify the owner/operator as to the details and, if appropriate, recommend work stoppage and possibly remedial actions. The MQA/CQA engineer is normally hired by the owner/operator and functions separately of the contractors and owner/operator. The MQA/CQA engineer must be a registered professional engineer who has shown competency and experience in similar projects and is considered qualified by the permitting agency. It is recommended that the person's resume and record on like facilities must be submitted in writing and accordingly accepted by the permitting agency before activities commence. The permitting agency may request additional information from the prospective MQA/CQA engineer and his/her associated organization including experience record, education, registry and ownership details. The permitting agency may accept or deny the MQA/CQA engineer's qualifications based on such data and revelations. If the permitting agency requests additional information or denies the MQA/CQA engineer's qualifications it should be done prior to construction, so that alternatives can be made which do not negatively impact on the progress of the work. The MQA/CQA engineer is usually required to be at the construction site during all major construction operations to oversee MQA/CQA personnel. The MQA/CQA engineer is usually the MQA/CQA certification engineer who certifies the completed project.

Table 1.1 - Recommended Impentation Program for Construction Quality Control (CQC) for Geosynthetics* (Beginning January 1, 1993)

| No. of Field Crews** At Each Site | End of 18 Months (i.e., June 30, 1994) | End of 36 Months (i.e., January 1, 1996) |
|-----------------------------------|--|--|
| 1-4 | 1 - Level II | 1 - Level III*** |
| ≥ 5 | 1 - Level II | 1 - Level III*** |
| | 2 - Level I | 1 - Level I |

*Certification for natural materials is under development as of this writing
 **Performing a Critical Operation; Typically 4 to 6 People/Crew
 ***Or PE with applicable experience

- *MQA/CQA Personnel.* Manufacturing quality assurance and construction quality assurance personnel are responsible for making observations and performing field tests to ensure that a facility is constructed in accord with the plans and specifications approved by the permitting agency. MQA/CQA personnel normally are employed by the same firm as the MQA/CQA engineer, or by a firm hired by the firm employing the MQA/CQA engineer. Construction MQA/CQA personnel report to the MQA/CQA engineer. A relatively large proportion (if not the entire group) of the MQA/CQA staff should be certified. Table 1.2 gives the currently recommended implementation schedule. As mentioned previously, certification examinations have been available as of October, 1992, from the National Institute for Certification of Engineering Technologies in Alexandria, Virginia.

- **Testing Laboratory.** Many MQC/CQC and MQA/CQA tests are performed by commercial laboratories. The testing laboratory should have its own internal QC plan to ensure that laboratory procedures conform to the appropriate American Society for Testing and Materials (ASTM) standards or other applicable testing standards. The testing laboratory is responsible for ensuring that tests are performed in accordance with applicable methods and standards, for following internal QC procedures, for maintaining sample chain-of-custody records, and for reporting data. The testing laboratory must be willing to allow the owner/operator, permitting agency, design engineer, installer, or MQA/CQA engineer to observe the sample preparation and testing procedures, or record-keeping procedures, if they so desire. The owner/operator, permitting agency, design engineer, or MQA/CQA engineer may request that they be allowed to observe some or all tests on a particular job at any time, either announced or unannounced. The testing laboratory personnel must be willing to accommodate such a request, but the observer should not interfere with the testing or slow the testing process.

Table 1.2 - Recommended Implementation Program for Construction Quality Assurance (CQA) for Geosynthetics* (Beginning January 1, 1993)

| No. of Field Crews** At Each Site | End of 18 Months (i.e., June 30, 1994) | End of 36 Months (i.e., January 1, 1996) |
|-----------------------------------|--|---|
| 1-2 | 1 - Level II | 1 - Level III*** |
| 3-4 | 1 - Level II 1 - Level I | 1 - Level III*** 1 - Level I |
| ≥ 5 | 1 - Level II 2 - Level I | 1 - Level III*** 1 - Level II 1 - Level I |

*Certification for natural materials is under development as of this writing
 **Performing a Critical Operation; Typically 4 to 6 People/Crew
 ***Or PE with applicable experience

- **MQA/CQA Certifying Engineer.** The MQA/CQA certifying engineer is responsible for certifying to the owner/operator and permitting agency that, in his or her opinion, the facility has been constructed in accord with plans and specifications and MQA/CQA document approved by the permitting agency. The certification statement is normally accompanied by a final MQA/CQA report that contains all the appropriate documentation, including daily observation reports, sampling locations, test results, drawings of record or sketches, and other relevant data. The MQA/CQA certifying engineer may be the MQA/CQA engineer or someone else in the MQA/CQA engineer's organization who is a registered professional engineer with experience and competency in certifying like installations.

1.3 Personnel Qualifications

The key individuals involved in MQA/CQA and their minimum recommended qualifications are listed in Table 1.3.

Table 1.3 - Recommended Personnel Qualifications

| Individual | Minimum Recommended Qualifications |
|---|--|
| Design Engineer | Registered Professional Engineer |
| Owner's Representative | The specific individual designated by the owner with knowledge of the project, its plans, specifications and QC/QA documents. |
| Manufacturer/Fabricator | Experience in manufacturing, or fabricating, at least 1,000,000 m ² (10,000,000 ft ²) of similar geosynthetic materials. |
| MQC Personnel | Manufacturer, or fabricator, trained personnel in charge of quality control of the geosynthetic materials to be used in the specific waste containment facility. |
| MQC Officer | The individual specifically designated by a manufacturer or fabricator, in charge of geosynthetic material quality control. |
| Geosynthetic Installer's Representative | Experience installing at least 1,000,000 m ² (10,000,000 ft ²) of similar geosynthetic materials. |
| CQC Personnel | Employed by the general contractor, installation contractor or earthwork contractor involved in waste containment facilities; certified to the extent shown in Table 1.1. |
| CQA Personnel | Employed by an organization that operates separately from the contractor and the owner/operator; certified to the extent shown in Table 1.2. |
| MQA/CQA Engineer | Employed by an organization that operates separately from the contractor and owner/operator; registered Professional Engineer and approved by permitting agency. |
| MQA/CQA Certifying Engineer | Employed by an organization that operates separately from the contractor and owner/operator; registered Professional Engineer in the state in which the waste containment facility is constructed and approved by the appropriate permitting agency. |

1.4 Written MQA/COA Plan

Quality assurance begins with a quality assurance plan. This includes both MQA and CQA. These activities are never ad hoc processes that are developed while they are being implemented. A written MQA/CQA plan must precede any field construction activities.

The MQA/CQA plan is the owner/operator's written plan for MQA/CQA activities. The MQA/CQA plan should include a detailed description of all MQA/CQA activities that will be used during materials manufacturing and construction to manage the installed quality of the facility. The MQA/CQA plan should be tailored to the specific facility to be constructed and be completely integrated into the project plans and specifications. Differences should be settled before any construction work commences.

Most state and federal regulatory agencies require that a MQA/CQA plan be submitted by the owner/operator and be approved by that agency prior to construction. The MQA/CQA plan is usually part of the permit application.

A copy of the site-specific plans and specifications, MQA/CQA plan, and MQA/CQA documentation reports should be retained at the facility by the owner/operator or the MQA/CQA engineer. The plans, specifications, and MQA/CQA documents may be reviewed during a site inspection by the permitting agency and will be the chief means for the facility owner/operator to demonstrate to the permitting agency that MQA/CQA objectives for a project are being met.

Written MQA/CQA plans vary greatly from project to project. No general outline or suggested list of topics is applicable to all projects or all regulatory agencies. The elements covered in this document provides guidance on topics that should be addressed in the written MQA/CQA plan.

1.5 Documentation

A major purpose of the MQA/CQA process is to provide documentation for those individuals who were unable to observe the entire construction process (e.g., representatives of the permitting agency) so that those individuals can make informed judgments about the quality of construction for a project. MQA/CQA procedures and results must be thoroughly documented.

1.5.1 Daily Inspection Reports

Routine daily reporting and documentation procedures should be required. Inspectors should prepare daily written inspection reports that may ultimately be included in the final MQA/CQA document. Copies of these reports should be available from the MQA/CQA engineer. The daily reports should include information about work that was accomplished, tests and observations that were made, and descriptions of the adequacy of the work that was performed.

1.5.2 Daily Summary Reports

A daily written summary report should be prepared by the MQA/CQA engineer. This report provides a chronological framework for identifying and recording all other reports and aids in tracking what was done and by whom. As a minimum, the daily summary reports should contain the following (modified from Spigolon and Kelly, 1984, and EPA, 1986):

- Date, project name, location, waste containment unit under construction, personnel involved in major activities and other relevant identification information;
- Description of weather conditions, including temperature, cloud cover, and precipitation;
- Summaries of any meetings held and actions recommended or taken;
- Specific work units and locations of construction underway during that particular day;
- Equipment and personnel being utilized in each work task, including subcontractors;
- Identification of areas or units of work being inspected;
- Unique identifying sheet number of geomembranes for cross referencing and document control;
- Description of off-site materials received, including any quality control data provided by the supplier;
- Calibrations or recalibrations of test equipment, including actions taken as a result of recalibration;
- Decisions made regarding approval of units of material or of work, and/or corrective actions to be taken in instances of substandard or suspect quality;
- Unique identifying sheet numbers of inspection data sheets and/or problem reporting and corrective measures used to substantiate any MQA/CQA decisions described in the previous item;
- Signature of the MQA/CQA engineer.

1.5.3 Inspection and Testing Reports

All observations, results of field tests, and results of laboratory tests performed on site or off site should be recorded on a suitable data sheet. Recorded observations may take the form of notes, charts, sketches, photographs, or any combination of these. Where possible, a checklist may be useful to ensure that pertinent factors are not overlooked.

As a minimum, the inspection data sheets should include the following information (modified from Spigolon and Kelly, 1984, and EPA, 1986):

- Description or title of the inspection activity;
- Location of the inspection activity or location from which the sample was obtained;
- Type of inspection activity and procedure used (reference to standard method when appropriate or specific method described in MQA/CQA plan);
- Unique identifying geomembrane sheet number for cross referencing and document control;

- Recorded observation or test data;
- Results of the inspection activity (e.g., pass/fail); comparison with specification requirements;
- Personnel involved in the inspection besides the individual preparing the data sheet;
- Signature of the MQA/CQA inspector and review signature by the MQA/CQA engineer.

1.5.4 Problem Identification and Corrective Measures Reports

A problem is defined as material or workmanship that does not meet the requirements of the plans, specifications or MQA/CQA plan for a project or any obvious defect in material or workmanship, even if there is conformance with plans, specifications and the MQA/CQA plan. As a minimum, problem identification and corrective measures reports should contain the following information (modified from EPA, 1986):

- Location of the problem;
- Description of the problem (in sufficient detail and with supporting sketches or photographic information where appropriate) to adequately describe the problem;
- Unique identifying geomembrane sheet number for cross referencing and document control;
- Probable cause;
- How and when the problem was located (reference to inspection data sheet or daily summary report by inspector);
- Where relevant, estimation of how long the problem has existed;
- Any disagreement noted by the inspector between the inspector and contractor about whether or not a problem exists or the cause of the problem;
- Suggested corrective measure(s);
- Documentation of correction if corrective action was taken and completed prior to finalization of the problem and corrective measures report (reference to inspection data sheet, where applicable);
- Where applicable, suggested methods to prevent similar problems;
- Signature of the MQA/CQA inspector and review signature of MQA/CQA engineer.

1.5.5 Drawings of Record

Drawings of record (also called “as-built” drawings) should be prepared to document the actual lines and grades and conditions of each component of the disposal unit. For soil components, the record drawings shall include survey data that show bottom and top elevations of a particular component, the plan dimensions of the component, and locations of all destructive test samples. For geosynthetic components, the record drawings often show the dimensions of all

geomembrane field panels, the location of each panel, identification of all seams and panels with appropriate identification numbering or lettering, location of all patches and repairs, and location of all destructive test samples. Separate drawings are often needed to show record cross sections and special features such as sump areas.

1.5.6 Final Documentation and Certification

At the completion of a project, or a component of a large project, the owner/operator should submit a final report to the permitting agency. This report may include all of the daily inspection reports, the daily MQA/CQA engineer's summary reports, inspection data sheets, problem identification and corrective measures reports, and other documentation such as quality control data provided by manufacturers or fabricators, laboratory test results, photographs, as-built drawings, internal MQA/CQA memoranda or reports with data interpretation or analyses, and design changes made by the design engineer during construction. The document should be certified correct by the MQA/CQA certifying engineer.

The final documentation should emphasize that areas of responsibility and lines of authority were clearly defined, understood, and accepted by all parties involved in the project (assuming that this was the case). Signatures of the owner/operator's representative, design engineer, MQA/CQA engineer, general contractor's representative, specialty subcontractor's representative, and MQA/CQA certifying engineer may be included as confirmation that each party understood and accepted the areas of responsibility and lines of authority outlined in the MQA/CQA plan.

1.5.7 Document Control

The MQA/CQA documents which have been agreed upon should be maintained under a document control procedure. Any portion of the document(s) which are modified must be communicated to and agreed upon by all parties involved. An indexing procedure should be developed for convenient replacement of pages in the MQA/CQA plan, should modifications become necessary, with revision status indicated on appropriate pages.

A control scheme should be implemented to organize and index all MQA/CQA documents. This scheme should be designed to allow easy access to all MQA/CQA documents and should enable a reviewer to identify and retrieve original inspection reports or data sheets for any completed work element.

1.5.8 Storage of Records

During construction, the MQA/CQA engineer should be responsible for all MQA/CQA documents. This includes a copy of the design criteria, plans, specifications, MQA/CQA plan, and originals of all data sheets and reports. Duplicate records should be kept at another location to avoid loss of this valuable information if the originals are destroyed.

Once construction is complete, the document originals should be stored by the owner/operator in a manner that will allow for easy access while still protecting them from damage. An additional copy should be kept at the facility if this is in a different location from the owner/operator's main files. A final copy should be kept by the permitting agency. All documentation should be maintained through the operating and post-closure monitoring periods of the facility by the owner/operator and the permitting agency in an agreed upon format (paper hard copy, microfiche, electronic medium, etc.).

1.6 Meetings

Communication is extremely important to quality management. Quality construction is easiest to achieve when all parties involved understand clearly their responsibility and authority. Meetings can be very helpful to make sure that responsibility and authority of each organization is clearly understood. During construction, meetings can help to resolve problems or misunderstandings and to find solutions to unanticipated problems that have developed.

1.6.1 Pre-Bid Meeting

The first meeting is held to discuss the MQA/CQA plan and to resolve differences of opinion before the project is let for bidding. The pre-bid meeting is held after the permitting agency has issued a permit for a waste containment facility and before a construction contract has been awarded. The pre-bid meeting is held before construction bids are prepared so that the companies bidding on the construction will better understand the level of MQA/CQA to be employed on the project. Also, if the bidders identify problems with the MQA/CQA plan, this affords the owner/operator an opportunity to rectify those problems early in the process.

1.6.2 Resolution Meeting

The objectives of the resolution meeting are to establish lines of communication, review construction plans and specifications, emphasize the critical aspects of a project necessary to ensure proper quality, begin planning and coordination of tasks, and anticipate any problems that might cause difficulties or delays in construction. The meeting should be attended by the owner/operator's representative, design engineer, representatives of the general contractor and/or major subcontractors, the MQA/CQA engineer, and the MQA/CQA certifying engineer.

The resolution meeting normally involves the following activities:

- An individual is assigned to take minutes (usually a representative of the owner/operator or of the MQA/CQA engineer's organization);
- Individuals are introduced to one another and their responsibilities (or potential responsibilities) are identified;
- Copies of the project plans and specifications are made available for discussion;
- The MQA/CQA plan is distributed;
- Copies of any special permit restrictions that are relevant to construction or MQA/CQA are distributed;
- The plans and specifications are described, any unique design features are discussed (so the contractors will understand the rationale behind the general design), any potential construction problems are identified and discussed, and questions from any of the parties concerning the construction are discussed;
- The MQA/CQA plan is reviewed and discussed, with the MQA/CQA engineer and MQA/CQA certifying engineer identifying their expectations and identifying the most critical components;

- Procedures for MQC/CQC proposed by installers and contractors are reviewed and discussed;
- Corrective actions to resolve potential construction problems are discussed;
- Procedures for documentation and distribution of documents are discussed;
- Each organization's responsibility, authority, and lines of communication are discussed;
- Suggested modifications to the MQA/CQA plan that would improve quality management on the project are solicited; and
- Construction variables (e.g., precipitation, wind, temperature) and schedule are discussed.

It is very important that the procedures for inspection and testing be known to all, that the criteria for pass/fail decisions be clearly defined (including the resolution of test data outliers), that all parties understand the key problems that the MQA/CQA personnel will be particularly careful to identify, that each individual's responsibilities and authority be understood, and that procedures regarding resolution of problems be understood. The resolution meeting may be held in conjunction with either the pre-bid meeting (rarely) or the pre-construction meeting (often).

1.6.3 Pre-construction Meeting

The pre-construction meeting is held after a general construction contract has been awarded and the major subcontractors and material suppliers are established. It is usually held concurrent with the initiation of construction. The purpose of this meeting is to review the details of the MQA/CQA plan, to make sure that the responsibility and authority of each individual is clearly understood, to agree on procedures to resolve construction problems, and to establish a foundation of cooperation in quality management. The pre-construction meeting should be attended by the owner/operator's representative, design engineer, representatives of the general contractor and major subcontractors, the MQA/CQA engineer, the MQA/CQA certifying engineer, and a representative from the permitting agency, if that agency expects to visit the site during construction or independently observe MQA/CQA procedures.

The pre-construction meeting should include the following activities:

- Assign an individual (usually representative of MQA/CQA engineer) to take minutes;
- Introduce parties and identify their responsibility and authority;
- Distribute the MQA/CQA plan, identify any revisions made after the resolution meeting, and answer any questions about the MQA/CQA plan, procedures, or documentation;
- Discuss responsibilities and lines of communication;
- Discuss reporting procedures, distribution of documents, schedule for any regular meetings, and resolution of construction problems;
- Review site requirements and logistics, including safety procedures;

- Review the design, discuss the most critical aspects of the construction, and discuss scheduling and sequencing issues;
- Discuss MQC procedures that the geosynthetics manufacturer(s) will employ;
- Discuss CQC procedures that the installer or contractor will employ, for example, establish and agree on geomembrane repair procedures;
- Make a list of action items that require resolution and assign responsibilities for these items.

1.6.4 Progress Meetings

Weekly progress meetings should be held. Weekly meetings can be helpful in maintaining lines of communication, resolving problems, identifying action items, and improving overall quality management. When numerous critical work elements are being performed, the frequency of these meetings can be increased to biweekly, or even daily. Persons who should attend this meeting are those involved in the specific issues being discussed. At all times the MQA/CQA engineer, or designated representative, should be present.

1.7 Sample Custody

All samples shall be identified as described in the MQA/CQA plan. Whenever a sample is taken, a chain of custody record should be made for that sample. If the sample is transferred to another individual or laboratory, records shall be kept of the transfer so that chain of custody can be traced. The purpose of keeping a record of sample custody is to assist in tracing the cause of anomalous test results or other testing problem, and to help prevent accidental loss of test samples.

Soil samples are usually discarded after testing. Destructive testing samples of geosynthetic materials are often taken in triplicate, with one sample tested by CQC personnel, one tested by CQA personnel, and the third retained in storage as prescribed in the CQA plan.

1.8 Weather

Weather can play a critical role in the construction of waste containment facilities. Installation of all geosynthetic materials (including geosynthetic clay liners) and natural clay liners is particularly sensitive to weather conditions, including temperature, wind, humidity, and precipitation. The contractor or installer is responsible for complying with the contract plans and specifications (along with the MQC/CQC plans for the various components of the system). Included in this information should be details which restrict the weather conditions in which certain activities can take place. It is the responsibility of the contractor or installer to make sure that these weather restrictions are observed during construction.

1.9 Work Stoppages

Unexpected work stoppages can occur due to a variety of causes, including labor strikes, contractual disputes, weather, QC/QA problems, etc. The MQA/CQA engineer should be particularly careful during such stoppages to determine (1) whether in-place materials are covered and protected from damage (e.g., lifting of a geomembrane by wind or premature hydration of geosynthetic clay liners); (2) whether partially covered materials are protected from damage (e.g., desiccation of a compacted clay liners); and (3) whether manufactured materials are properly stored and properly or adequately protected (e.g., whether geotextiles are protected from ultraviolet

exposure). The cessation of construction should not mean the cessation of MQA/CQA inspection and documentation.

1.10 References

- Spigolon, S.J., and M.F. Kelly (1984), "Geotechnical Assurance of Construction of Disposal Facilities," U. S. Environmental Protection Agency, EPA 600/2-84-040, Cincinnati, Ohio.
- U.S. Environmental Protection Agency (1986), "Technical Guidance Document, Construction Quality Assurance for Hazardous Waste Land Disposal Facilities," EPA/530-SW-86-031, Cincinnati, Ohio, 88 p.
- U.S. Environmental Protection Agency (1988a), "Design, Construction, and Evaluation of Clay Liners for Waste Management Facilities," EPA/530-SW-86-007F, Cincinnati, Ohio.
- U.S. Environmental Protection Agency (1988b), "Lining of Waste Containment and Other Impoundment Facilities," EPA/600/2-88/052, Cincinnati, Ohio.
- U. S. Environmental Protection Agency (1989), "Requirements for Hazardous Waste Landfill Design, Construction, and Closure," EPA/625/4-89/022, Cincinnati, Ohio.
- U.S. Environmental Protection Agency (1991a), "Inspection Techniques for the Fabrication of Geomembrane Field Seams," EPA/530/SW-91/051, Cincinnati, Ohio.
- U. S. Environmental Protection Agency (1991b), "Design and Construction of RCRA/CERCLA Final Covers," EPA/625/4-91/025, Cincinnati, Ohio.

Chapter 2

Compacted Soil Liners

2.1 Introduction and Background

2.1.1 Types of Compacted Soil Liners

Compacted soil liners have been used for many years as engineered hydraulic barriers for waste containment facilities. Some liner and cover systems contain a single compacted soil liner, but others may contain two or more compacted soil liners. Compacted soil liners are frequently used in conjunction with geomembranes to form a *composite liner*, which usually consists of a geomembrane placed directly on the surface of a compacted soil liner. Examples of soil liners used in liner and cover systems are shown in Fig. 2.1.

Compacted soil liners are composed of clayey materials that are placed and compacted in layers called *lifts*. The materials used to construct soil liners include natural mineral materials (natural soils), bentonite-soil blends, and other material

2.1.1.1 Natural Mineral Materials

The most common type of compacted soil liner is one that is constructed from naturally occurring soils that contain a significant quantity of clay. Soils are usually classified as CL, CH, or SC soils in the Unified Soil Classification System (USCS) and ASTM D-2487. Soil liner materials are excavated from locations called *borrow pits*. These borrow areas are located either on the site or offsite. The soil in the borrow pit may be used directly without processing or may be processed to alter the water content, break down large pieces of material, or remove oversized particles. Sources of natural soil liner materials include lacustrine deposits, glacial tills, aeolian materials, deltaic deposits, residual soils, and other types of soil deposits. Weakly cemented or highly weathered rocks, e.g., mudstones and shales, can also be used for soil liner materials, provided they are processed properly.

2.1.1.2 Bentonite-Soil Blends

If the soils found in the vicinity of a waste disposal facility are not sufficiently clayey to be suitable for direct use as a soil liner material, a common practice is to blend natural soils available on or near a site with bentonite. The term *bentonite* is used in different ways by different people. For purposes of this discussion, bentonite is any commercially processed material that is composed primarily of the mineral smectite. Bentonite may be supplied in granular or pulverized form. The dominant adsorbed cation of commercial bentonite is usually sodium or calcium, although the sodium form is much more commonly used for soil sealing applications. Bentonite is mixed with native soils either in thin layers or in a pugmill.

2.1.1.3 Other

Other materials have occasionally been used for compacted soil liners. For example, bentonite may be blended with flyash to form a liner under certain circumstances. Modified soil minerals and commercial additives, e.g., polymers, have sometimes been used.

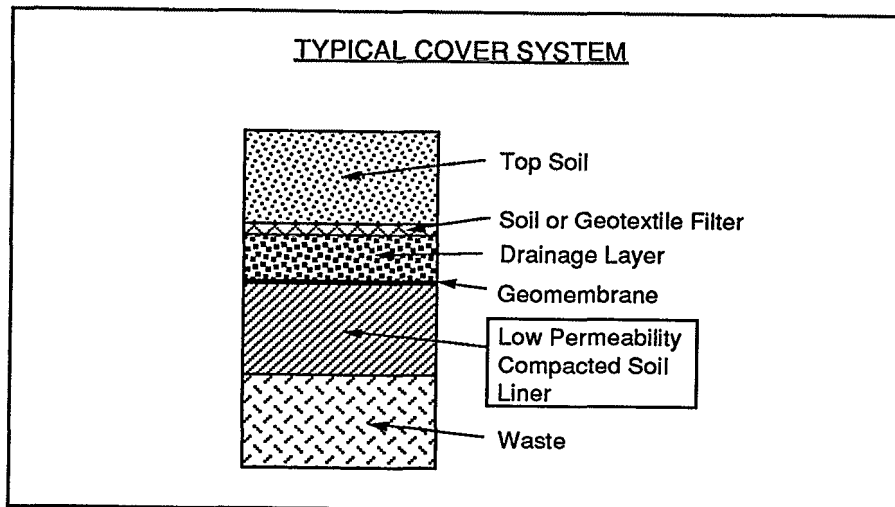
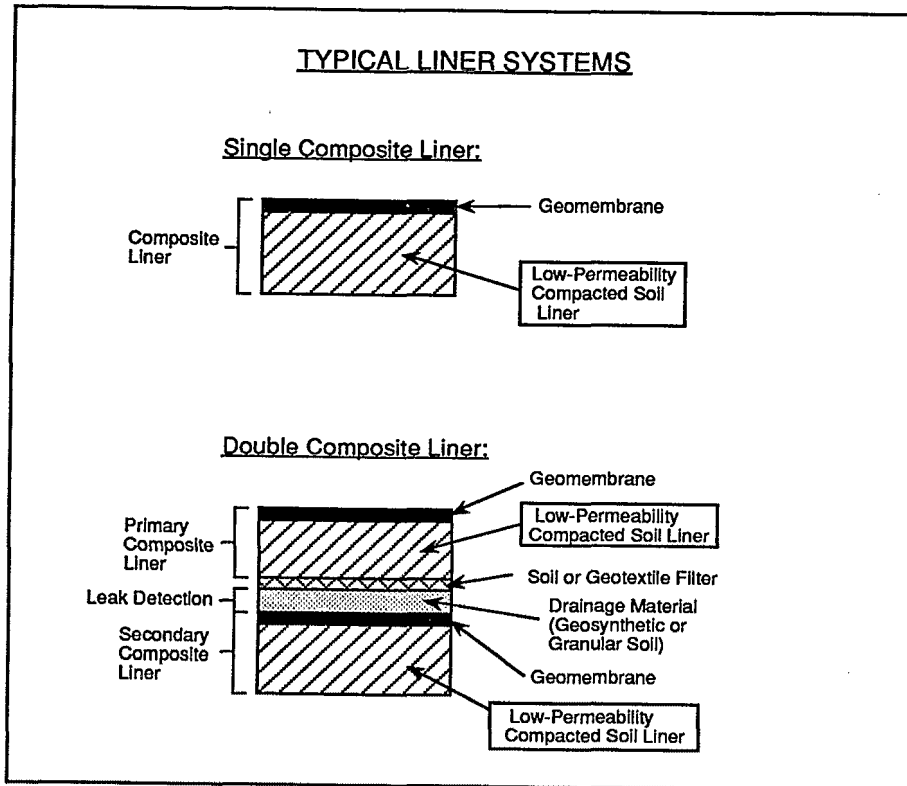

Figure 2.1 - Examples of Compacted Soil Liners in Liner and Cover Systems

2.1.2 Critical CQC and CQA Issues

The CQC and CQA processes for soil liners are intended to accomplish three objectives:

1. Ensure that soil liner materials are suitable.
2. Ensure that soil liner materials are properly placed and compacted.
3. Ensure that the completed liner is properly protected.

Some of these issues, such as protection of the liner from desiccation after completion, simply require application of common-sense procedures. Other issues, such as preprocessing of materials, are potentially much more complicated because, depending on the material, many construction steps may be involved. Furthermore, tests alone will not adequately address many of the critical CQC and CQA issues -- visual observations by qualified personnel, supplemented by intelligently selected tests, provide the best approach to ensure quality in the constructed soil liner.

As discussed in Chapter 1, the objective of CQA is to ensure that the final product meets specifications. A detailed program of tests and observations is necessary to accomplish this objective. The objective of CQC is to control the manufacturing or construction process to meet project specifications. With geosynthetics, the distinction between CQC and CQA is obvious: the geosynthetics installer performs CQC while an independent organization conducts CQA. However, CQC and CQA activities for soils are more closely linked than in geosynthetics installation. For example, on many earthwork projects the CQA inspector will typically determine the water content of the soil and report the value to the contractor; in effect, the CQA inspector is also providing CQC input to the contractor. On some projects, the contractor is required to perform extensive tests as part of the CQC process, and the CQA inspector performs tests to check or confirm the results of CQC tests.

The lack of clearly separate roles for CQC and CQA inspectors in the earthwork industry is a result of historic practices and procedures. This chapter is focused on CQA procedures for soil liners, but the reader should understand that CQA and CQC practices are often closely linked in earthwork. In any event, the QA plan should clearly establish QA procedures and should consider whether there will be QC tests and observations to complement the QA process.

2.1.3 Liner Requirements

The construction of soil liners is a challenging task that requires many careful steps. A blunder concerning any one detail of construction can have disastrous impacts upon the hydraulic conductivity of a soil liner. For example, if a liner is allowed to desiccate, cracks might develop that could increase the hydraulic conductivity of the liner to above the specified requirement.

As stated in Section 2.1.2, the CQC and CQA processes for soil liners essentially consist of using suitable materials, placing and compacting the materials properly, and protecting the completed liner. The steps required to fulfill these requirements may be summarized as follows:

1. The subgrade on which the soil liner will be placed should be properly prepared.
2. The materials employed in constructing the soil liner should be suitable and should conform to the plans and specifications for the project.

3. The soil liner material should be preprocessed, if necessary, to adjust the water content, to remove oversized particles, to break down clods of soil, or to add amendments such as bentonite.
4. The soil should be placed in lifts of appropriate thickness and then be properly remolded and compacted.
5. The completed soil liner should be protected from damage caused by desiccation or freezing temperatures.
6. The final surface of the soil liner should be properly prepared to support the next layer that will be placed on top of the soil liner.

The six steps mentioned above are described in more detail in the succeeding subsections to provide the reader with a general introduction to the nature of CQC and CQA for soil liners. Detailed requirements are discussed later.

2.1.3.1 Subgrade Preparation

The subgrade on which a soil liner is placed should be properly prepared, i.e., provide adequate support for compaction and be free from mass movements. The compacted soil liner may be placed on a natural or geosynthetic material, depending on the particular design and the individual component in the liner or cover system. If the soil liner is the lowest component of the liner system, native soil or rock forms the subgrade. In such cases the subgrade should be compacted to eliminate soft spots. Water should be added or removed as necessary to produce a suitably firm subgrade per specification requirements. In other instances the soil liner may be placed on top of geosynthetic components of the liner system, e.g., a geotextile. In such cases, the main concern is the smoothness of the geosynthetic on which soil is placed and conformity of the geosynthetic to the underlying material (e.g., no bridging over ruts left by vehicle traffic).

Sometimes it is necessary to "tie in" a new section of soil liner to an old one, e.g., when a landfill is being expanded laterally. It is recommended that a lateral excavation be made about 3 to 6 m (10 to 20 ft) into the existing soil liner, and that the existing liner be stair-stepped as shown in Fig. 2.2 to tie the new liner into the old one. The surface of each of the steps in the old liner should be scarified to maximize bonding between the new and old sections.

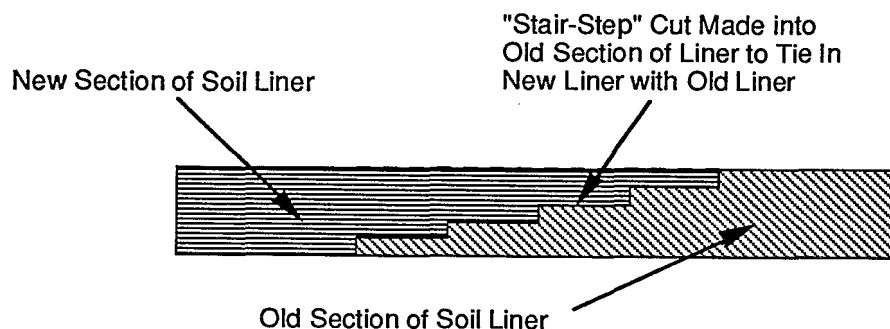

Figure 2.2 - Tie-In of New Soil Liner to Existing Soil Liner

2.1.3.2 Material Selection

Soil liner materials are selected so that a low hydraulic conductivity will be produced after the soil is remolded and compacted. Although the performance specification is usually hydraulic conductivity, CQA considerations dictate that restrictions be placed on certain properties of the soil used to build a liner. For example, limitations may be placed on the liquid limit, plastic limit, plasticity index, percent fines, and percent gravel allowed in the soil liner material.

The process of selecting construction materials and verifying the suitability of the materials varies from project to project. In general, the process is as follows:

1. A potential borrow source is located and explored to determine the vertical and lateral extent of the source and to obtain representative samples, which are tested for properties such as liquid limit, plastic limit, percent fines, etc.
2. Once construction begins, additional CQC and CQA observations and tests may be performed in the borrow pit to confirm the suitability of materials being removed.
3. After a lift of soil has been placed, additional CQA tests should be performed for final verification of the suitability of the soil liner materials.

On some projects, the process may be somewhat different. For example, a materials company may offer to sell soil liner materials from a commercial pit, in which case the first step listed above (location of borrow source) is not relevant.

A variety of tests is performed at various stages of the construction process to ensure that the soil liner material conforms with specifications. However, tests alone will not necessarily ensure an adequate material -- observations by qualified CQA inspectors are essential to confirm that deleterious materials (such as stones or large pieces of organic or other deleterious matter) are not present in the soil liner material.

2.1.3.3 Preprocessing

Some soil liner materials must be processed prior to use. The principal preprocessing steps that may be required include the following:

1. Drying of soil that is too wet.
2. Wetting of soil that is too dry.
3. Removal of oversized particles.
4. Pulverization of clods of soil.
5. Homogenization of nonuniform soil.
6. Addition of bentonite.

Tests are performed by CQA personnel to confirm proper preprocessing, but visual observations by CQC and CQA personnel are needed to confirm that proper procedures have been followed and that the soil liner material has been properly preprocessed.

2.1.3.4 Placement, Remolding, and Compaction

Soil liners are placed and compacted in lifts. The soil liner material must first be placed in a loose lift of appropriate thickness. If a loose lift is too thick, adequate compactive energy may not be delivered to the bottom of a lift.

The type and weight of compaction equipment can have an important influence upon the hydraulic conductivity of the constructed liner. The CQC/CQA program should be designed to ensure that the soil liner material will be properly placed, remolded, and compacted as described in the plans and specifications for the project.

2.1.3.5 Protection

The completed soil liner must be protected from damage caused by desiccation or freezing temperatures. Each completed lift of the soil liner, as well as the completed liner, must be protected.

2.1.3.6 Final Surface Preparation

The surface of the liner must be properly compacted and smoothed to serve as a foundation for an overlying geomembrane liner or other component of a liner or cover system. Verification of final surface preparation is an important part of the CQA process.

2.1.4 Compaction Requirements

One of the most important aspects of constructing soil liners that have low hydraulic conductivity is the proper remolding and compaction of the soil. Background information on soil compaction is presented in this subsection.

2.1.4.1 Compaction Curve

A compaction curve is developed by preparing several samples of soil at different water contents and then sequentially compacting each of the samples into a mold of known volume with a specified compaction procedure. The total unit weight (γ), which is also called the wet density, of each specimen is determined by weighing the compacted specimen and dividing the total weight by the total volume. The water content (w) of each compacted specimen is determined by oven drying the specimen. The dry unit weight (γ_d), which is sometimes called the dry density, is calculated as follows:

$$\gamma_d = \gamma / (1 + w) \quad (2.1)$$

The (w , γ_d) points are plotted and a smooth curve is drawn between the points to define the compaction curve (Fig. 2.3). Judgment rather than an analytic algorithm is usually employed to draw the compaction curve through the measured points.

The *maximum dry unit weight* ($\gamma_{d,max}$) occurs at a water content that is called the *optimum water content*, w_{opt} (Fig. 2.3). The main reason for developing a compaction curve is to determine the optimum water content and maximum dry unit weight for a given soil and compaction procedure.

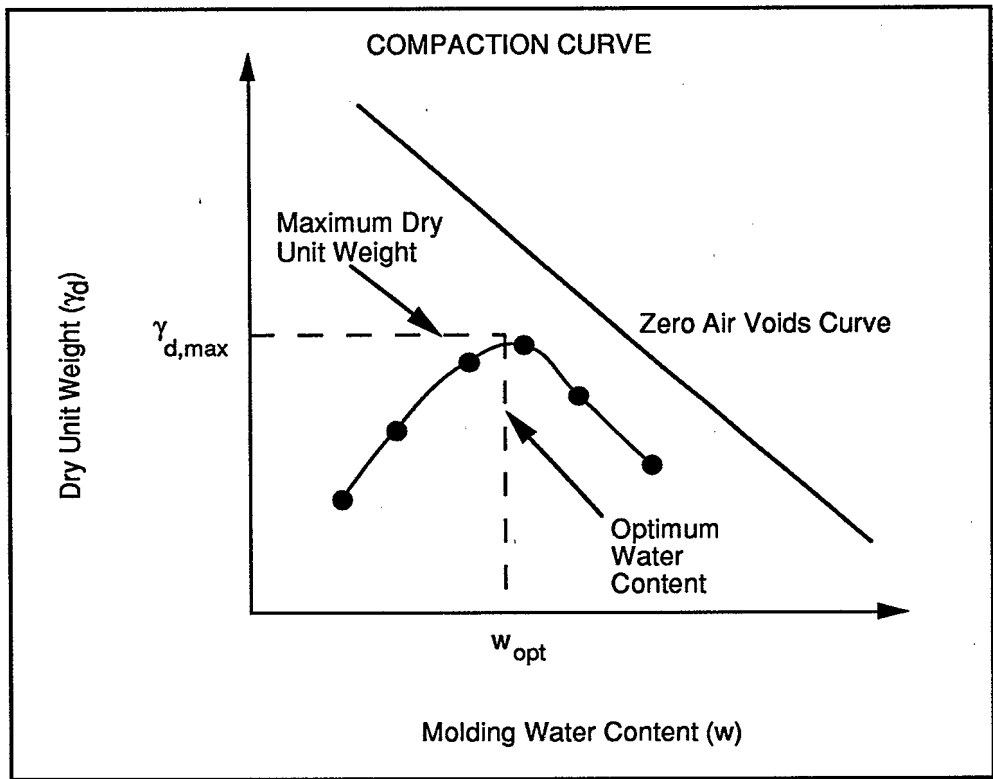
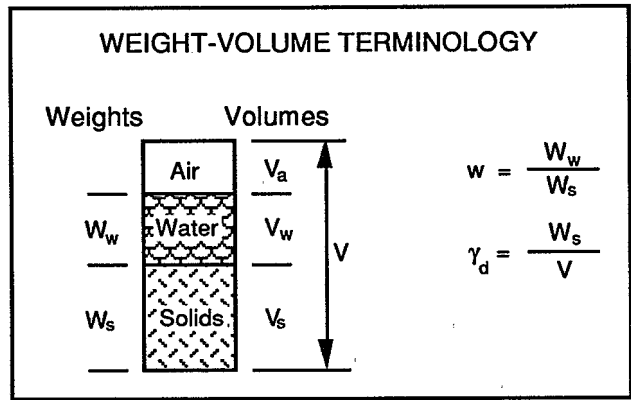

Figure 2.3 - Compaction Curve

The *zero air voids curve* (Fig. 2.3), also known as the *100% saturation curve*, is a curve that relates dry unit weight to water content for a saturated soil that contains no air. The equation for the zero air voids curve is:

$$\gamma_d = \gamma_w/[w + (1/G_s)] \quad (2.2)$$

where G_s is the specific gravity of solids (typically 2.6 to 2.8) and γ_w is the unit weight of water. If the soil's specific gravity of solids changes, the zero air voids curve will also change. Theoretically, no points on a plot of dry unit weight versus water content should lie above the zero air voids curve, but in practice some points usually lie slightly above the zero air voids curve as a result of soil variability and inherent limitations in the accuracy of water content and unit weight measurements (Schmertmann, 1989).

Benson and Boutwell (1992) summarize the maximum dry unit weights and optimum water content measured on soil liner materials from 26 soil liner projects and found that the degree of saturation at the point of (w_{opt} , $\gamma_{d,max}$) ranged from 71% to 98%, based on an assumed G_s value of 2.75. The average degree of saturation at the optimum point was 85%.

2.1.4.2 Compaction Tests

Several methods of laboratory compaction are commonly employed. The two procedures that are most commonly used are standard and modified compaction. Both techniques usually involve compacting the soil into a mold having a volume of 0.00094 m³ (1/30 ft³). The number of lifts, weight of hammer, and height of fall are listed in Table 2.1. The compaction tests are sometimes called *Proctor* tests after Proctor, who developed the tests and wrote about the procedures in several 1933 issues of Engineering News Record. Thus, the compaction curves are sometimes called Proctor curves, and the maximum dry unit weight may be termed the *Proctor density*.

Table 2.1 - Compaction Test Details

| Compaction Procedure | Number of Lifts | Weight of Hammer | Height of Fall | Compactive Energy |
|----------------------|-----------------|--------------------|--------------------|--|
| Standard | 3 | 24.5N (5.5 lbs) | 305 mm (12 in.) | 594 kN-m/m ³ (12,375 ft-lb/ft ³) |
| Modified | 5 | 44.5N (10 lbs) | 457 mm (18 in.) | 2,693 kN-m/m ³ (56,250 ft-lb/ft ³) |

Proctor's original test, now frequently called the *standard Proctor compaction test*, was developed to control compaction of soil bases for highways and airfields. The maximum dry unit weights attained from the standard Proctor compaction test were approximately equal to unit weights observed in the field on well-built fills using compaction equipment available in the 1920s and 1930s. During World War II, much heavier compaction equipment was developed and the unit weights attained from field compaction sometimes exceeded the laboratory values. Proctor's original procedure was modified by increasing compactive energy. By today's standards:

- Standard Compaction (ASTM D-698) produces maximum dry unit weights approximately equal to field dry unit weights for soils that are well compacted using modest-sized compaction equipment.
- Modified Compaction (ASTM D-1557) produces maximum dry unit weights approximately equal to field dry unit weights for soils that are well compacted using the heaviest compaction equipment available.

2.1.4.3 Percent Compaction

The compaction test is used to help CQA personnel to determine: 1) whether the soil is at the proper water content for compaction, and 2) whether the soil has received adequate compactive effort. Field CQA personnel will typically measure the water content of the field-compacted soil (w) and compare that value with the optimum water content (w_{opt}) from a laboratory compaction test. The construction specifications may limit the value of w relative to w_{opt} , e.g., specifications may require w to be between 0 and +4 percentage points of w_{opt} . Field CQC personnel should measure the water content of the soil prior to remolding and compaction to ensure that the material is at the proper water content before the soil is compacted. However, experienced earthwork personnel can often tell if the soil is at the proper water content from the look and feel of the soil. Field CQA personnel should measure the water content and unit weight after compaction to verify that the water content and dry unit weight meet specifications. Field CQA personnel often compute the percent compaction, P , which is defined as follows:

$$P = \gamma_d / \gamma_{d,max} \times 100\% \quad (2.3)$$

where γ_d is the dry unit weight of the field-compacted soil. Construction specifications often stipulate a minimum acceptable value of P .

In summary, the purpose of the laboratory compaction test as applied to CQC and CQA is to provide water content (w_{opt}) and dry unit weight ($\gamma_{d,max}$) reference points. The actual water content of the field-compacted soil liner may be compared to the optimum value determined from a specified laboratory compaction test. If the water content is not in the proper range, the engineering properties of the soil are not likely to be in the range desired. For example, if the soil is too wet, the shear strength of the soil may be too low. Similarly, the dry unit weight of the field-compacted soil may be compared to the maximum dry unit weight determined from a specified laboratory compaction test. If the percent compaction is too low, the soil has probably not been adequately compacted in the field. Compaction criteria may also be established in ways that do not involve percent compaction, as discussed later, but one way or another, the laboratory compaction test provides a reference point.

2.1.4.4 Estimating Optimum Water Content and Maximum Dry Unit Weight

Many CQA plans require that the water content and dry unit weight of the field-compacted soil be compared to values determined from laboratory compaction tests. Compaction tests are a routine part of nearly all CQA programs. However, from a practical standpoint, performing compaction tests introduces two problems:

1. A compaction test often takes 2 to 4 days to complete -- field personnel cannot wait for the completion of a laboratory compaction test to make "pass-fail" decisions.

2. The soil will inevitably be somewhat variable -- the optimum water content and maximum dry unit weight will vary. The values of w_{opt} and $\gamma_{d,max}$ appropriate for one location may not be appropriate for another location. This has been termed a "mismatch" problem (Noorany, 1990).

Because dozens (sometimes hundreds) of field water content and density tests are performed, it is impractical to perform a laboratory compaction test each and every time a field measurement of water content and density is obtained. Alternatively, simpler techniques for estimating the maximum dry unit weight are almost always employed for rapid field CQA assessments. These techniques are subjective assessment, one-point compaction test, and three-point compaction test.

2.1.4.4.1 Subjective Assessment

Relatively homogeneous fill materials produce similar results when repeated compaction tests are performed on the soil. A common approach is to estimate optimum water content and maximum dry unit weight based on the results of previous compaction tests. The results of at least 2 to 3 laboratory compaction tests should be available from tests on borrow soils prior to actual compaction of any soil liner material for a project. With subjective assessment, CQA personnel estimate the optimum water content and maximum dry unit weight based upon the results of the previously-completed compaction tests and their evaluation of the soil at a particular location in the field. Slight variations in the composition of fill materials will cause only slight variations in w_{opt} and $\gamma_{d,max}$. As an approximate guide, a relatively homogeneous borrow soil would be considered a material in which w_{opt} does not vary by more than ± 3 percentage points and $\gamma_{d,max}$ does not vary by more than ± 0.8 kN/ft³ (5 pcf). The optimum water content and maximum dry unit weight should not be estimated in this manner if the soil is heterogeneous -- too much guess work and opportunity for error would exist.

2.1.4.4.2 One-Point Compaction Test

The results of several complete compaction tests should always be available for a particular borrow source prior to construction, and the data base should expand as a project progresses and additional compaction tests are performed. The idea behind a one-point compaction test is shown in Fig. 2.4. A sample of soil is taken from the field and dried to a water content that appears to be just dry of optimum. An experienced field technician can usually tell without much difficulty when the water content is just dry of optimum. The sample of soil is compacted into a mold of known volume according to the compaction procedure relevant to a particular project, e.g., ASTM D-698 or D-1557. The weight of the compacted specimen is measured and the total unit weight is computed. The sample is dried using one of the rapid methods of measurement discussed later to determine water content. Dry unit weight is computed from Eq. 2.2. The water content-dry unit weight point from the one-point compaction test is plotted as shown in Fig. 2.4 and used in conjunction with available compaction curves to estimate w_{opt} and $\gamma_{d,max}$. One assumes that the shape of the compaction is similar to the previously-developed compaction curves and passes through the one point that has been determined.

The dashed curve in Fig. 2.4 is the estimated compaction curve. The one-point compaction test is commonly used for variable soils. In extreme cases, a one-point compaction test may be required for nearly all field water content and density measurements for purposes of computing percent compaction. However, if the material is so variable to require a one-point compaction test for nearly all field density measurements, the material is probably too variable to be suitable for use in a soil liner. The best use of the one-point compaction test is to assist with estimation of the optimum water content and maximum dry unit weight for questionable materials and to fill in data

gaps when results of complete compaction tests are not available quickly enough.

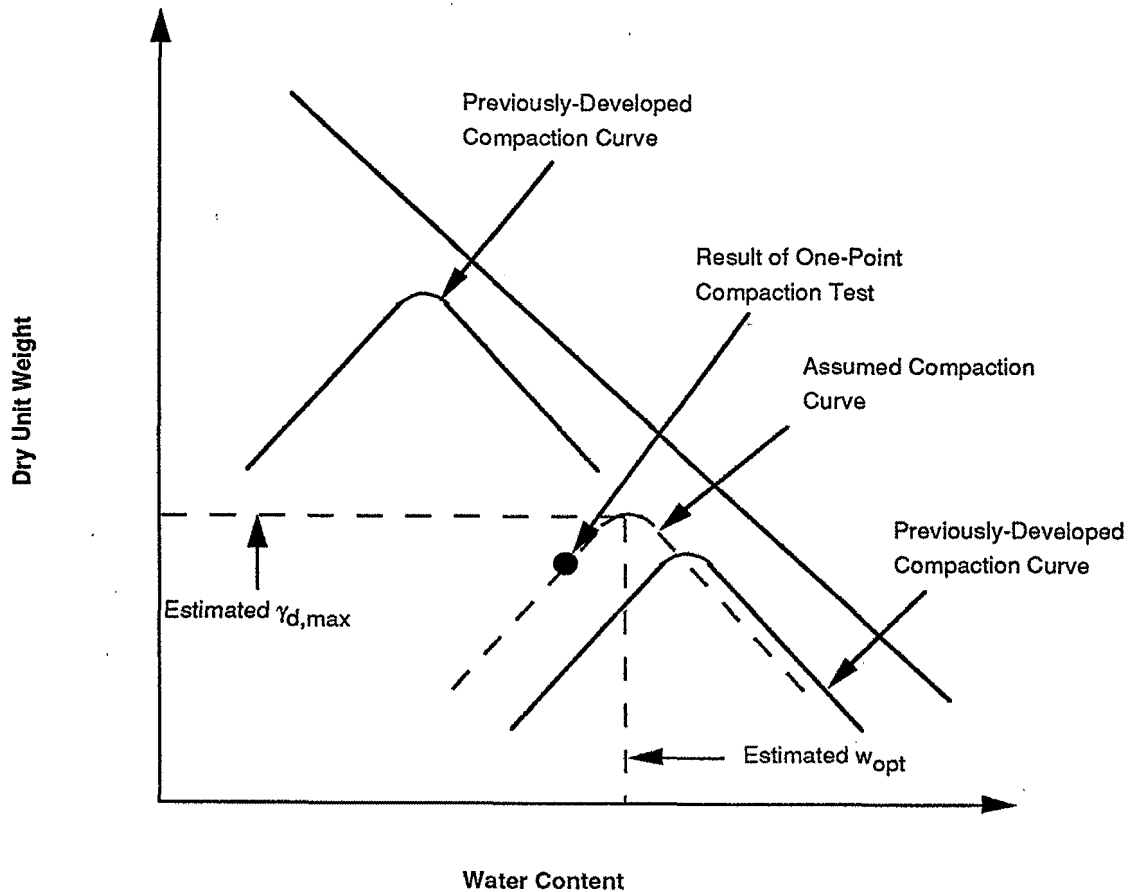

Figure 2.4 - One-Point Compaction Test

2.1.4.4.3 Three-Point Compaction Test (ASTM D-5080)

A more reliable technique than the one-point compaction test for estimating the optimum water content and maximum dry unit weight is to use a minimum of three compaction points to define a curve rather than relying on a single compaction point. A representative sample of soil is obtained from the field at the same location where the in-place water content and dry unit weight have been measured. The first sample of soil is compacted at the field water content. A second sample is prepared at a water content two percentage points wetter than the first sample and is compacted. However, for extremely wet soils that are more than 2% wet of optimum (which is often the case for soil liner materials), the second sample should be dried 2% below natural water content. Depending on the outcome of this compaction test, a third sample is prepared at a water content either two percentage points dry of the first sample or two percentage points wet of the second sample (or, for wet soil liners, 2 percentage points dry of the second sample). A parabola

is fitted to the three compaction data points and the optimum water content and maximum dry unit weight are determined from the equation of the best-fit parabola. This technique is significantly more time consuming than the one-point compaction test but offers 1) a standard ASTM procedure and 2) greater reliability and repeatability in estimated w_{opt} and $\gamma_{d,max}$.

2.1.4.5 Recommended Procedure for Developing Water Content-Density Specification

One of the most important aspects of CQC and CQA for soil liners is documentation of the water content and dry unit weight of the soil immediately after compaction. Historically, the method used to specify water content and dry unit weight has been based upon experience with structural fill. Design engineers often require that soil liners be compacted within a specified range of water content and to a minimum dry unit weight. The "Acceptable Zone" shown in Fig. 2.5 represents the zone of acceptable water content/dry unit weight combinations that is often prescribed. The shape of the Acceptable Zone shown in Fig. 2.5 evolved empirically from construction practices applied to roadway bases, structural fills, embankments, and earthen dams. The specification is based primarily upon the need to achieve a minimum dry unit weight for adequate strength and limited compressibility. As discussed by Mundell and Bailey (1985), Boutwell and Hedges (1989), and Daniel and Benson (1990), this method of specifying water content and dry unit weight is not necessarily the best method for compacted soil liners.

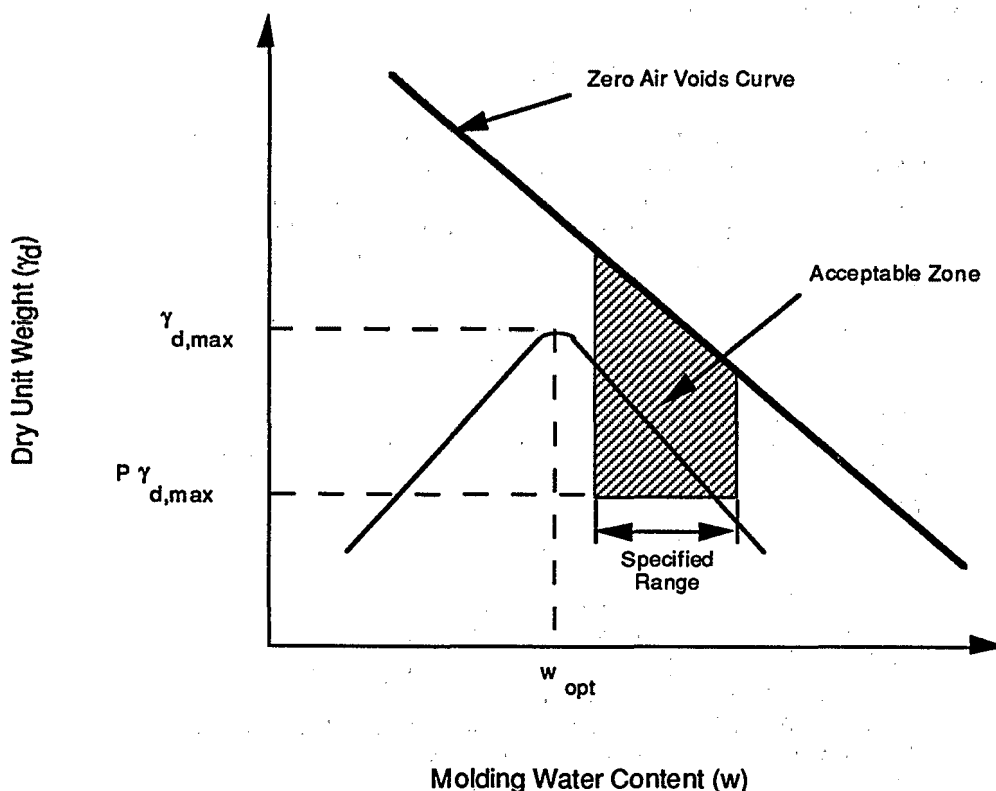

Figure 2.5 - Form of Water Content-Dry Unit Weight Specification Often Used in the Past

The recommended approach is intended to ensure that the soil liner will be compacted to a water content and dry unit weight that will lead to low hydraulic conductivity and adequate engineering performance with respect to other considerations, e.g., shear strength. Rational specification of water content/dry unit weight criteria should be based upon test data developed for each particular soil. Field test data would be better than laboratory data, but the cost of determining compaction criteria in the field through a series of test sections would almost always be prohibitive. Because the compactive effort will vary in the field, a logical approach is to select several compactive efforts in the laboratory that span the range of compactive effort that might be anticipated in the field. If this is done, the water content/dry unit weight criterion that evolves would be expected to apply to any reasonable compactive effort.

For most earthwork projects, modified Proctor effort represents a reasonable upper limit on the compactive effort likely to be delivered to the soil in the field. Standard compaction effort (ASTM D-698) likely represents a medium compactive effort. It is conceivable that soil in some locations will be compacted with an effort less than that of standard Proctor compaction. A reasonable lower limit of compactive energy is the "reduced compaction" procedure in which standard compaction procedures (ASTM D-698) are followed except that only 15 drops of the hammer per lift are used instead of the usual 25 drops. The reduced compaction procedure is the same as the 15 blow compaction test described by the U.S. Army Corps of Engineers (1970). The reduced compactive effort is expected to correspond to a reasonable minimum level of compactive energy for a typical soil liner or cover. Other compaction methods, e.g., kneading compaction, could be used. The key is to span the range of compactive effort expected in the field with laboratory compaction procedures.

One satisfactory approach is as follows:

1. Prepare and compact soil in the laboratory with modified, standard, and reduced compaction procedures to develop compaction curves as shown in Fig. 2.6a. Make sure that the soil preparation procedures are appropriate; factors such as clod size reduction may influence the results (Benson and Daniel, 1990). Other compaction procedures can be used if they better simulate field compaction and span the range of compactive effort expected in the field. Also, as few as two compaction procedures can be used if field construction procedures make either the lowest or highest compactive energy irrelevant.
2. The compacted specimens should be permeated, e.g., per ASTM D-5084. Care should be taken to ensure that permeation procedures are correct, with important details such as degree of saturation and effective confining stress carefully selected. The measured hydraulic conductivity should be plotted as a function of molding water content as shown in Fig. 2.6b.
3. As shown in Fig. 2.6c, the dry unit weight/water content points should be replotted with different symbols used to represent compacted specimens that had hydraulic conductivities greater than the maximum acceptable value and specimens with hydraulic conductivities less than or equal to the maximum acceptable value. An "Acceptable Zone" should be drawn to encompass the data points representing test results meeting or exceeding the design criteria. Some judgment is usually necessary in constructing the Acceptable Zone from the data points. Statistical criteria (e.g., Boutwell and Hedges, 1989) may be introduced at this stage.

4. The Acceptable Zone should be modified (Fig. 2.6d) based on other considerations such as shear strength. Additional tests are usually necessary in order to define the acceptable range of water content and dry unit weight that satisfies both hydraulic conductivity and shear strength criteria. Figure 2.7 illustrates how one might overlap Acceptable Zones defined from hydraulic conductivity and shear strength considerations to define a single Acceptable Zone. The same procedure can be applied to take into consideration other factors such as shrink/swell potential relevant to any particular project.

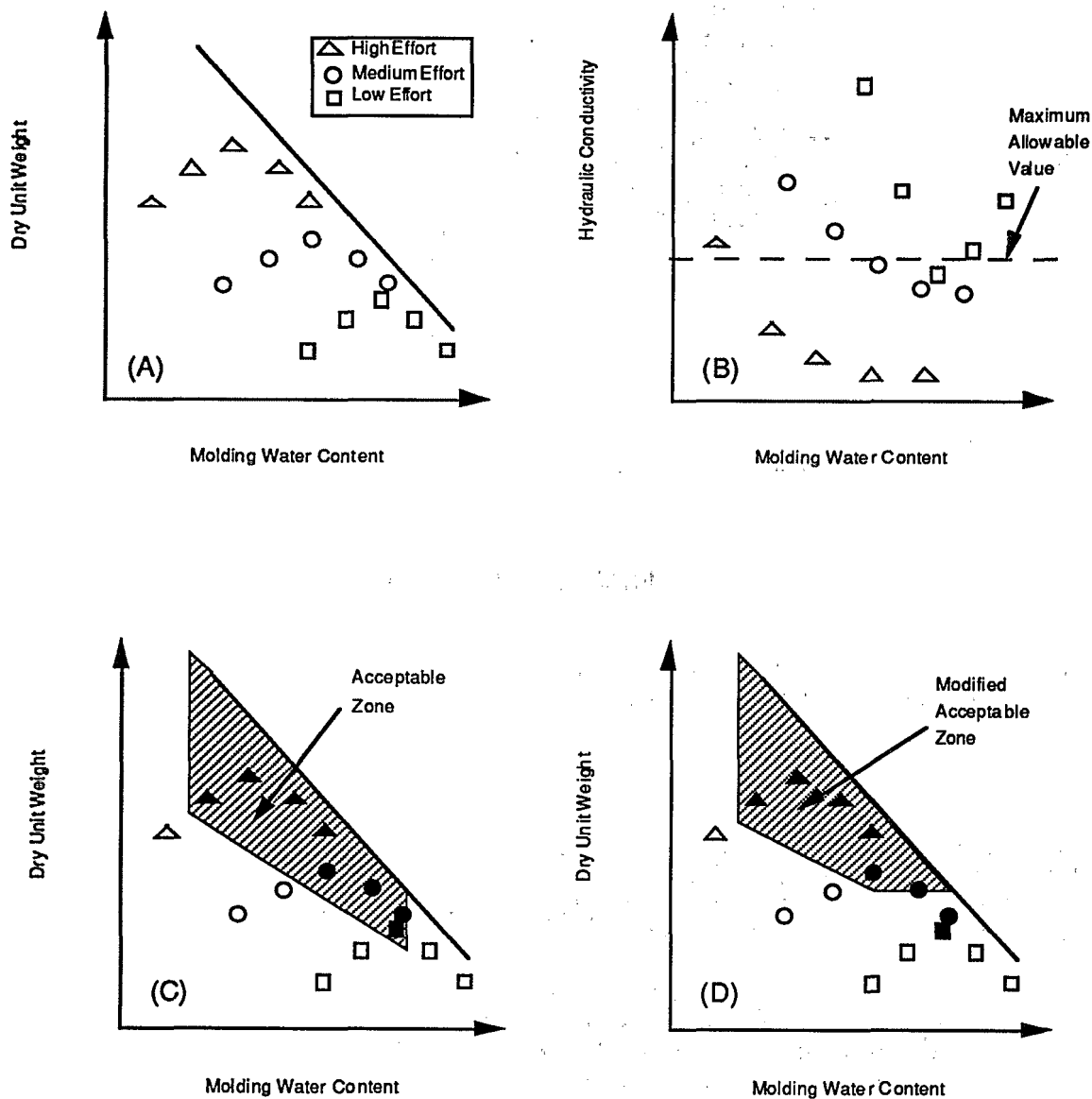

Figure 2.6 - Recommended Procedure to Determine Acceptable Zone of Water Content/Dry Unit Weight Values Based Upon Hydraulic Conductivity Considerations (after Daniel and Benson, 1990).

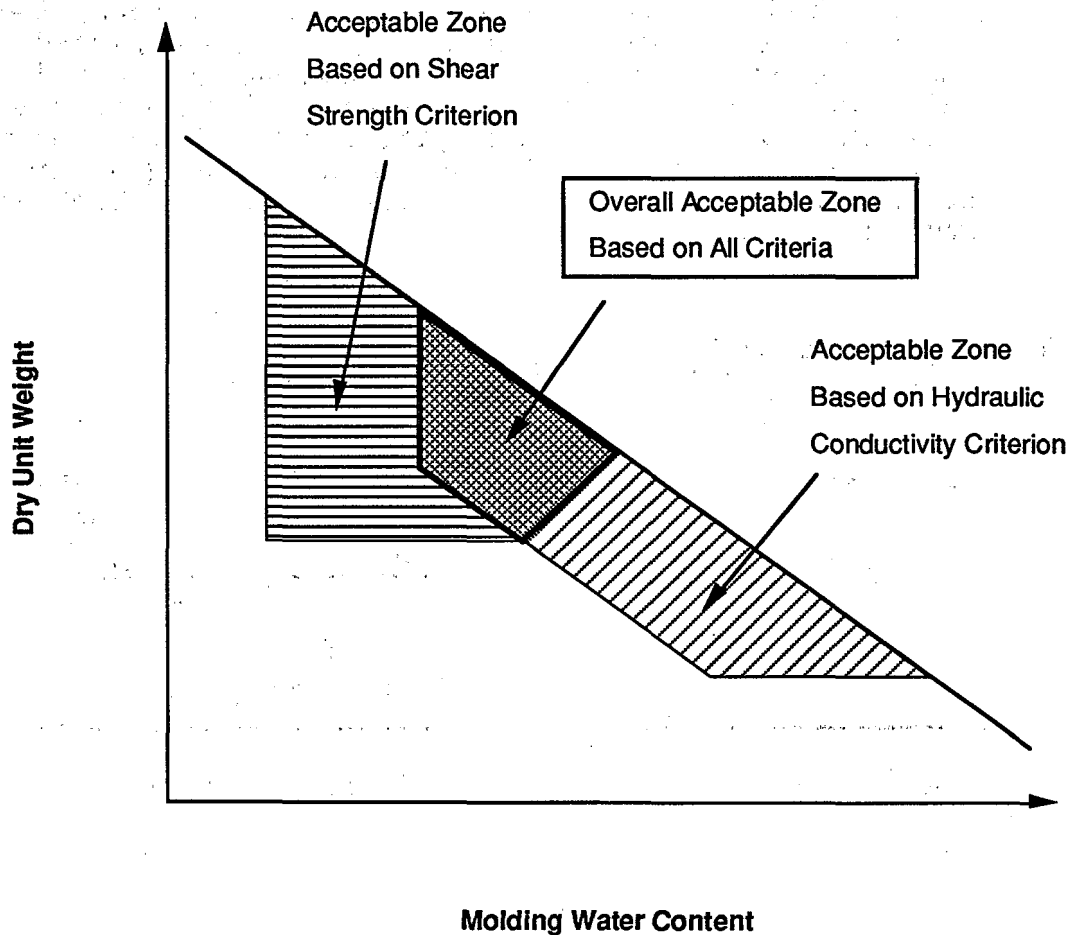

Figure 2.7 - Acceptable Zone of Water Content/Dry Unit Weights Determined by Superposing Hydraulic Conductivity and Shear Strength Data (after Daniel and Benson, 1990).

The same general procedure just outlined may also be used for soil-bentonite mixtures. However, to keep the scope of testing reasonable, the required amount of bentonite should be determined before the main part of the testing program is initiated. The recommended procedure for soil-bentonite mixes may be summarized as follows:

1. The type, grade, and gradation of bentonite that will be used should be determined. This process usually involves estimating costs from several potential suppliers. A sufficient quantity of the bentonite likely to be used for the project should be obtained and tested to characterize the bentonite (characterization tests are discussed later).
2. A representative sample of the soil to which the bentonite will be added should be obtained.

3. Batches of soil-bentonite mixtures should be prepared by blending in bentonite at several percentages, e.g., 2%, 4%, 6%, 8%, and 10% bentonite. Bentonite content is defined as the weight or mass of bentonite divided by the weight or mass of soil mixed with bentonite. For instance, if 5 kg of bentonite are mixed with 100 kg of soil, the bentonite content is 5%. Some people use the gross weight of bentonite rather than oven dry weight. Since air-dry bentonite usually contains 10% to 15% hygroscopic water by weight, the use of oven-dry, air-dry, or damp weight can make a difference in the percentage. Similarly, the weight of soil may be defined as either moist or dry (air- or oven-dry) weight. The contractor would rather work with total (moist) weights since the materials used in forming a soil-bentonite blend do contain some water. However, the engineering characteristics are controlled by the relative amounts of dry materials. A dry-weight basis is generally recommended for definition of bentonite content, but CQC and CQA personnel must recognize that the project specifications may or may not be on a dry-weight basis.
4. Develop compaction curves for each soil-bentonite mixture prepared from Step 3 using the method of compaction appropriate to the project, e.g., ASTM D-698 or ASTM D-1557.
5. Compact samples at 2% wet of optimum for each percentage of bentonite using the same compaction procedure employed in Step 4.
6. Permeate the soils prepared from Step 5 using ASTM D-5084 or some other appropriate test method. Graph hydraulic conductivity versus percentage of bentonite.
7. Decide how much bentonite to use based on the minimum required amount determined from Step 6. The minimum amount of bentonite used in the field should always be greater than the minimum amount suggested by laboratory tests because mixing in the field is usually not as thorough as in the laboratory. Typically, the amount of bentonite used in the field is one to four percentage points greater than the minimum percent bentonite indicated by laboratory tests.
8. A master batch of material should be prepared by mixing bentonite with a representative sample of soil at the average bentonite content expected in the field. The procedures described earlier for determining the Acceptable Zone of water content and dry unit weight are then applied to the master batch.

2.1.5 Test Pads

Test pads are sometimes constructed and tested prior to construction of the full-scale compacted soil liner. The test pad simulates conditions at the time of construction of the soil liner. If conditions change, e.g., as a result of emplacement of waste materials over the liner, the properties of the liner will change in ways that are not normally simulated in a test pad. The objectives of a test pad should be as follows:

1. To verify that the materials and methods of construction will produce a compacted soil liner that meets the hydraulic conductivity objectives defined for a project, hydraulic conductivity should be measured with techniques that will characterize the large-scale hydraulic conductivity and identify any construction defects that cannot be observed with small-scale laboratory hydraulic conductivity tests.

2. To verify that the proposed CQC and CQA procedures will result in a high-quality soil liner that will meet performance objectives.
3. To provide a basis of comparison for full-scale CQA: if the test pad meets the performance objectives for the liner (as verified by appropriate hydraulic conductivity tests) and the full-scale liner is constructed to standards that equal or exceed those used in building the test pad, then assurance is provided that the full-scale liner will also meet performance objectives.
4. If appropriate, a test pad provides an opportunity for the facility owner to demonstrate that unconventional materials or construction techniques will lead to a soil liner that meets performance objectives.

In terms of CQA, the test pad can provide an extremely powerful tool to ensure that performance objectives are met. The authors recommend a test pad for any project in which failure of the soil liner to meet performance objectives would have a potentially important, negative environmental impact.

A test pad need not be constructed if results are already available for a particular soil and construction methodology. By the same token, if the materials or methods of construction change, an additional test pad is recommended to test the new materials or construction procedures. Specific CQA tests and observations that are recommended for the test pad are described later in Section 2.10.

2.2 Critical Construction Variables that Affect Soil Liners

Proper construction of compacted soil liners requires careful attention to construction variables. In this section, basic principles are reviewed to set the stage for discussion of detailed CQC and CQA procedures.

2.2.1 Properties of the Soil Material

The construction specifications place certain restrictions on the materials that can be used in constructing a soil liner. Some of the restrictions are more important than others, and it is important for CQC and CQA personnel to understand how material properties can influence the performance of a soil liner.

2.2.1.1 Plasticity Characteristics

The plasticity of a soil refers to the capability of a material to behave as a plastic, moldable material. Soils are said to be either plastic or non-plastic. Soils that contain clay are usually plastic whereas those that do not contain clay are usually non-plastic. If the soil is non-plastic, the soil is almost always considered unsuitable for a soil liner unless additives such as bentonite are introduced.

The plasticity characteristics of a soil are quantified by three parameters: liquid limit, plastic limit, and plasticity index. These terms are defined as follows:

- **Liquid Limit (LL):** The water content corresponding to the arbitrary limit between the liquid and plastic states of consistency of a soil.
- **Plastic Limit (PL):** The water content corresponding to the arbitrary limit between the

plastic and solid states of consistency of a soil.

- Plasticity Index (PI): The numerical difference between liquid and plastic limits, i.e., LL - PL.

The liquid limit and plastic limit are measured using ASTM D-4318.

Experience has shown that if the soil has extremely low plasticity, the soil will possess insufficient clay to develop low hydraulic conductivity when the soil is compacted. Also, soils that have very low PI's tend to grade into non-plastic soils in some locations. The question of how low the PI can be before the soil is not sufficiently plastic is impossible to answer universally. Daniel (1990) recommends that the soil have a $PI \geq 10\%$ but notes that some soils with PI's as low as 7% have been used successfully to build soil liners with extremely low in situ hydraulic conductivity (Albrecht and Cartwright, 1989). Benson et al. (1992) compiled a data base from CQA documents and related the hydraulic conductivity measured in the laboratory on small, "undisturbed" samples of field-compacted soil to various soil characteristics. The observed relationship between hydraulic conductivity and plasticity index is shown in Fig. 2.8. The data base reflects a broad range of construction conditions, soil materials, and CQA procedures. It is clear from the data base that many soils with PI's as low as approximately 10% can be compacted to achieve a hydraulic conductivity $\leq 1 \times 10^{-7}$ cm/s.

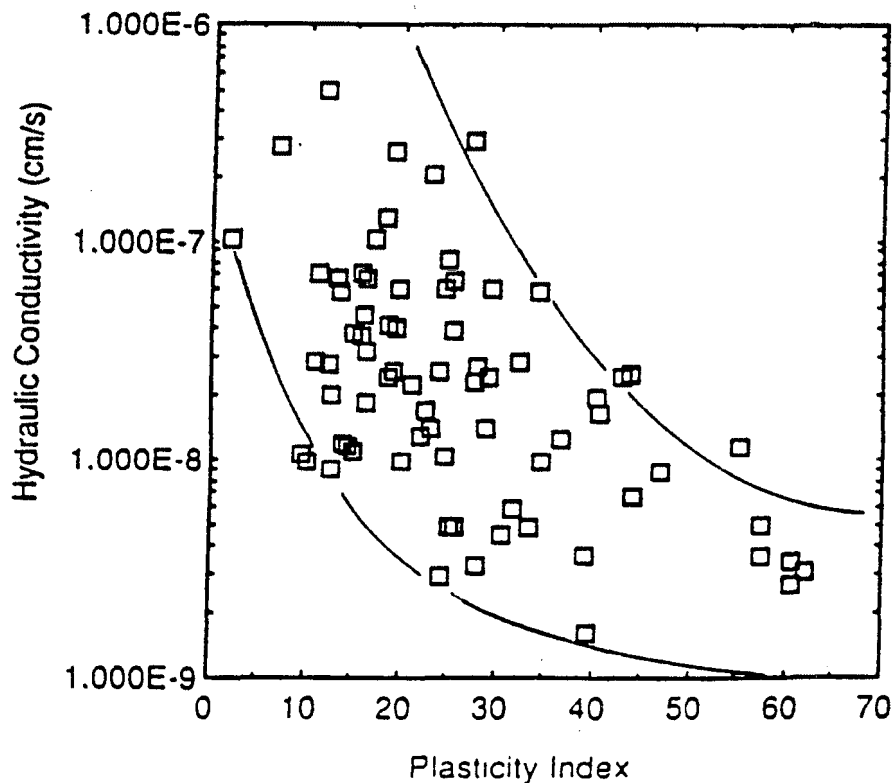

Figure 2.8 - Relationship between Hydraulic Conductivity and Plasticity Index (Benson et al., 1992)

Soils with high plasticity index (>30% to 40%) tend to form hard clods when dried and sticky clods when wet. Highly plastic soils also tend to shrink and swell when wetted or dried. With highly plastic soils, CQC and CQA personnel should be particularly watchful for proper processing of clods, effective remolding of clods during compaction, and protection from desiccation.

2.2.1.2 Percentage Fines

Some earthwork specifications place a minimum requirement on the percentage of fines in the soil liner material. *Fines* are defined as the fraction of soil that passes through the openings of the No. 200 sieve (opening size = 0.075 mm). Soils with inadequate fines typically have too little silt- and clay-sized material to produce suitably low hydraulic conductivity. Daniel (1990) recommends that the soil liner materials contain at least 30% fines. Data from Benson et al. (1992), shown in Fig. 2.9, suggest that a minimum of 50% fines might be an appropriate requirement for many soils. Field inspectors should check the soil to make sure the percentage of fines meets or exceeds the minimum stated in the construction specifications and should be particularly watchful for soils with less than 50% fines.

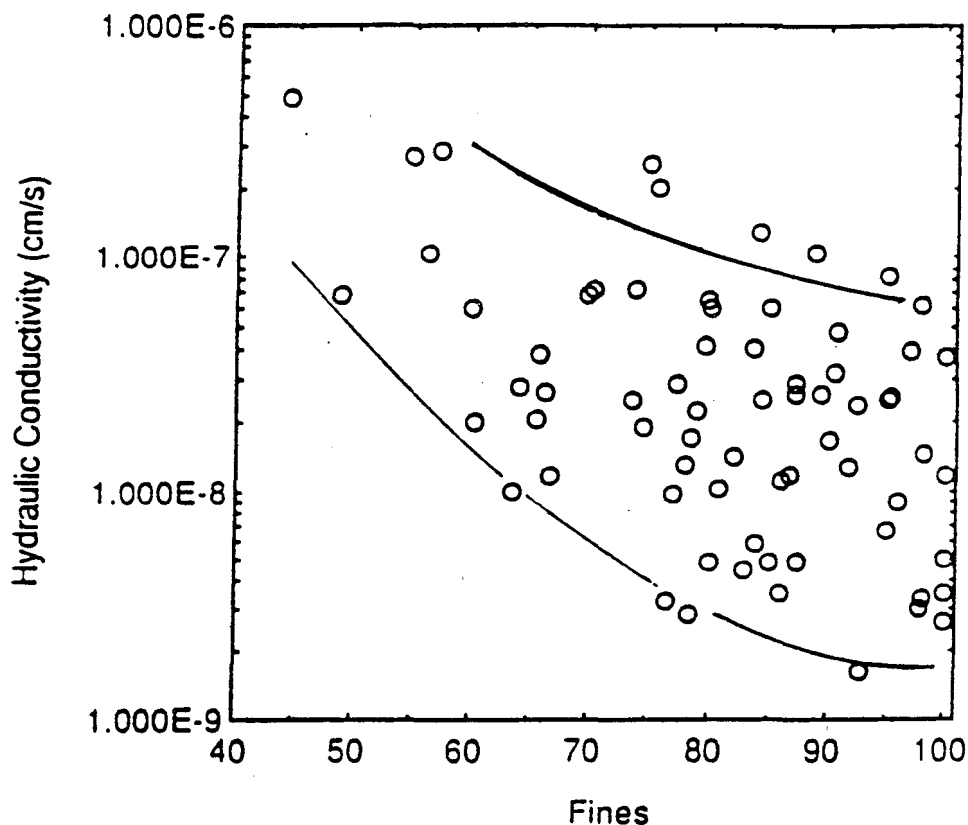

Figure 2.9 - Relationship between Hydraulic Conductivity and Percent Fines (Benson et al., 1992)

2.2.1.3 Percentage Gravel

Gravel is herein defined as particles that will not pass through the openings of a No. 4 sieve (opening size = 4.76 mm). Gravel itself has a high hydraulic conductivity. However, a relatively large percentage (up to about 50%) of gravel can be uniformly mixed with a soil liner material without significantly increasing the hydraulic conductivity of the material (Fig. 2.10). The hydraulic conductivity of mixtures of gravel and clayey soil is low because the clayey soil fills the voids between the gravel particles. The critical observation for CQA inspectors to make is for possible segregation of gravel into pockets that do not contain sufficient soil to plug the voids between the gravel particles. The uniformity with which the gravel is mixed with the soil is more important than the gravel content itself for soils with no more than 50% gravel by weight. Gravel also may possess the capability of puncturing geosynthetic materials -- the maximum size and the angularity of the gravel are very important for the layer of soil that will serve as a foundation layer for a geomembrane.

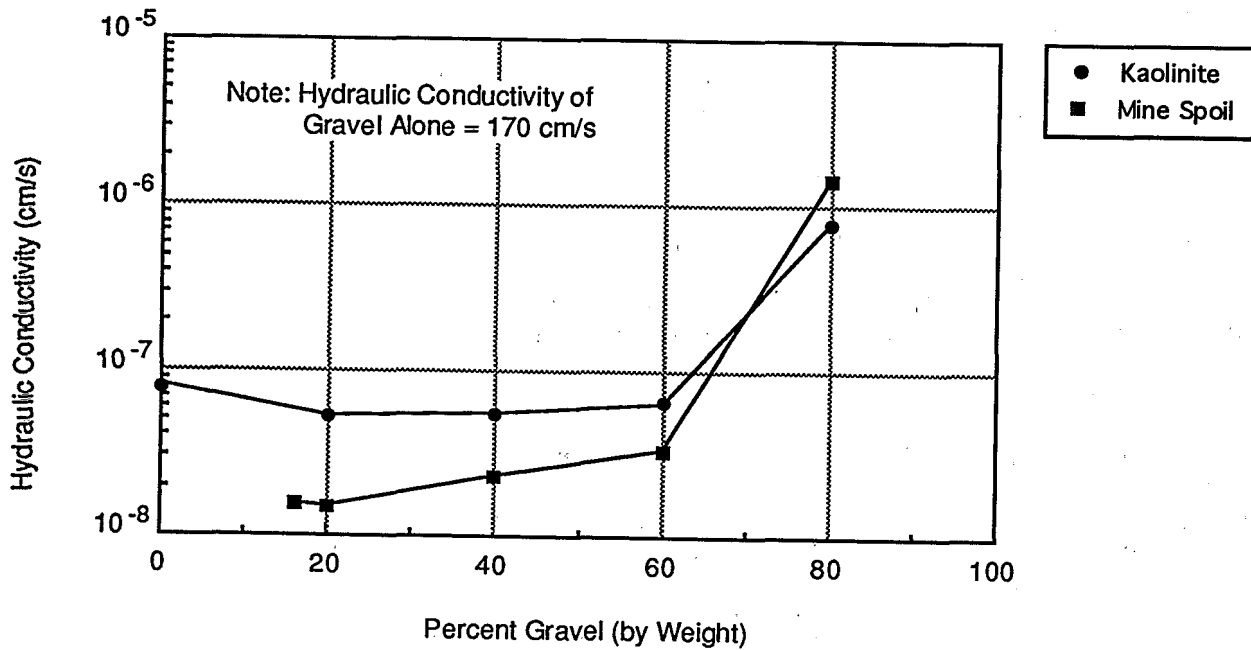

Figure 2.10 - Relationship between Hydraulic Conductivity and Percentage Gravel Added to Two Clayey Soils (after Shelley and Daniel, 1993).

2.2.1.4 Maximum Particle Size

The maximum particle size is important because: (1) cobbles or large stones can interfere with compaction, and (2) if a geomembrane is placed on top of the compacted soil liner, oversized particles can damage the geomembrane. Construction specifications may stipulate the maximum allowable particle size, which is usually between 25 and 50 mm (1 to 2 in.) for compaction considerations but which may be much less for protection against puncture of an adjacent geomembrane. If a geomembrane is to be placed on the soil liner, only the upper lift of the soil liner is relevant in terms of protection against puncture. Construction specifications may place one set of restrictions on all lifts of soil and place more stringent requirements on the upper lift to protect the geomembrane from puncture. Sieve analyses on small samples will not usually lead to detection of an occasional piece of oversized material. Observations by attentive CQC and CQA personnel are the most effective way to ensure that oversized materials have been removed. Oversized materials are particularly critical for the top lift of a soil liner if a geomembrane is to be placed on the soil liner to form a composite geomembrane/soil liner.

2.2.1.5 Clay Content and Activity

The clay content of the soil may be defined in several ways but it is usually considered to be the percentage of soil that has an equivalent particle diameter smaller than 0.005 or 0.002 mm, with 0.002 mm being the much more common definition. The clay content is measured by sedimentation analysis (ASTM D-422). Some construction specifications specify a minimum clay content but many do not.

A parameter that is sometimes useful is the activity, A , of the soil, which is defined as the plasticity index (expressed as a percentage) divided by the percentage of clay (< 0.002 mm) in the soil. A high activity (> 1) indicates that expandable clay minerals such as montmorillonite are present. Lambe and Whitman (1969) report that the activities of kaolinite, illite, and montmorillonite (three common clay minerals) are 0.38, 0.9, and 7.2, respectively. Activities for naturally occurring clay liner materials, which contain a mix of minerals, is frequently in the range of $0.5 \leq A \leq 1$.

Benson et al. (1992) related hydraulic conductivity to clay content (defined as particles < 0.002 mm) and reported the correlation shown in Fig. 2.11. The data suggest that soils must have at least 10% to 20% clay in order to be capable of being compacted to a hydraulic conductivity $\leq 1 \times 10^{-7}$ cm/s. However, Benson et al. (1992) also found that clay content correlated closely with plasticity index (Fig. 2.12). Soils with PI $> 10\%$ will generally contain at least 10% to 20% clay.

It is recommended that construction specification writers and regulation drafters indirectly account for clay content by requiring the soil to have an adequate percentage of fines and a suitably large plasticity index -- by necessity the soil will have an adequate amount of clay.

2.2.1.6 Clod Size

The term *clod* refers to chunks of cohesive soil. The maximum size of clods may be specified in the construction specifications. Clod size is very important for dry, hard, clay-rich soils (Benson and Daniel, 1990). These materials generally must be broken down into small clods in order to be properly hydrated, remolded, and compacted. Clod size is less important for wet soils -- soft, wet clods can usually be remolded into a homogeneous, low-hydraulic-conductivity mass with a reasonable compactive effort.

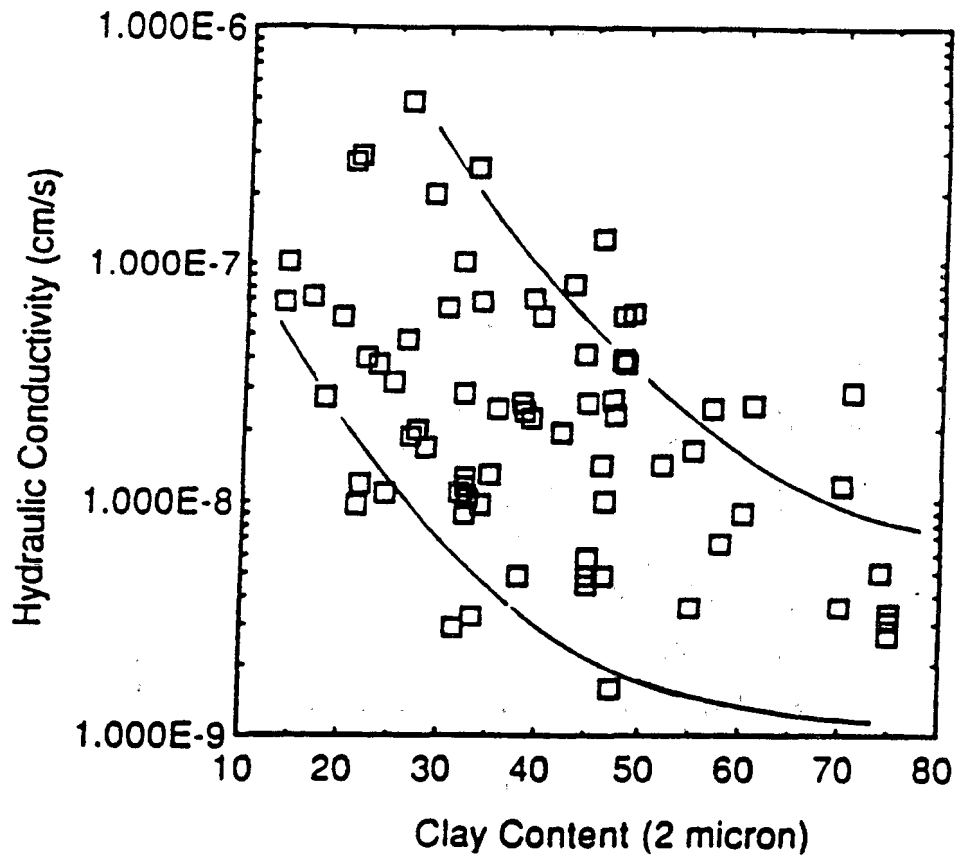

Figure 2.11 - Relationship between Hydraulic Conductivity and Clay Content (Benson et al., 1992)

No standard method is available to determine clod size. Inspectors should observe the soil liner material and occasionally determine the dimensions of clods by direct measurement with a ruler to verify conformance with construction specifications.

2.2.1.7 Bentonite

Bentonite may be added to clay-deficient soils in order to fill the voids between the soil particles with bentonite and to produce a material that, when compacted, has a very low hydraulic conductivity. The effect of the addition of bentonite upon hydraulic conductivity is shown in Fig. 2.13 for one silty sand. For this particular soil, addition of 4% sodium bentonite was sufficient to lower the hydraulic conductivity to less than 1×10^{-7} cm/s.

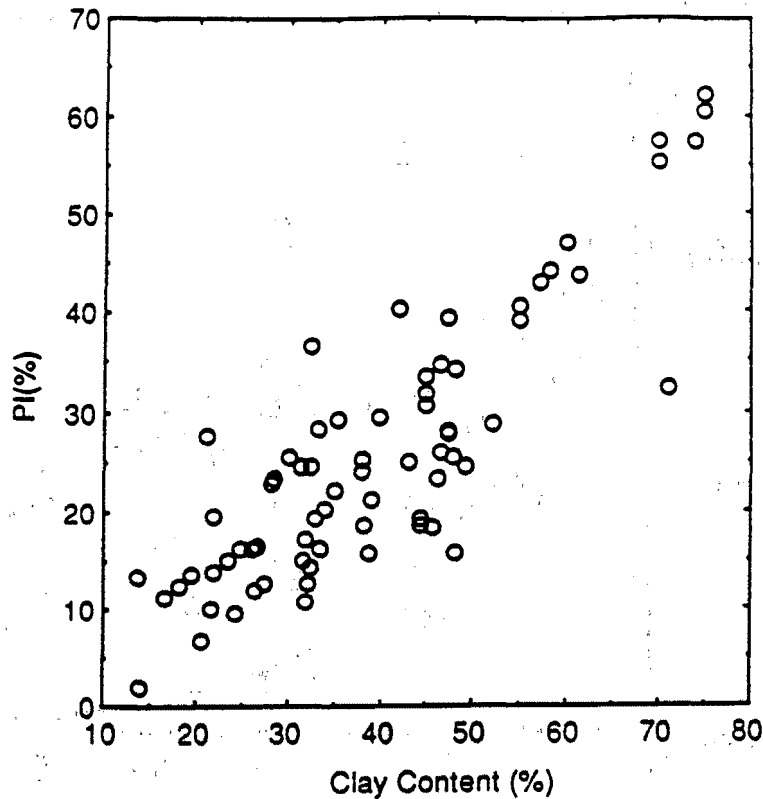

Figure 2.12 - Relationship between Clay Content and Plasticity Index (Benson et al., 1992)

The critical CQC and CQA parameters are the type of bentonite, the grade of bentonite, the grain size distribution of the processed bentonite, the amount of bentonite added to the soil, and the uniformity of mixing of the bentonite with the soil. Two types of bentonite are the primary commercial materials: sodium and calcium bentonite. Sodium bentonite has much greater water absorbency and swelling potential, but calcium bentonite may be more stable when exposed to certain chemicals. Sodium bentonite is used more frequently than calcium bentonite as a soil amendment for lining applications.

Any given type of bentonite may be available in several grades. The grade is a function of impurities in the bentonite, processing procedures, or additives. Some calcium bentonites are processed with sodium solutions to modify the bentonite to a sodium form. Some companies add polymers or other compounds to the bentonite to make the bentonite more absorbent of water or more resistant to alteration by certain chemicals.

Another variable is the gradation of the bentonite. A facet often overlooked by CQC and CQA inspectors is the grain size distribution of the processed bentonite. Bentonite can be ground

to different degrees. A fine, powdered bentonite will behave differently from a coarse, granular bentonite -- if the bentonite was supposed to be finely ground but too coarse a grade was delivered, the bentonite may be unsuitable in the mixture amounts specified. Because bentonite is available in variable degrees of pulverization, a sieve analysis (ASTM D422) of the processed dry bentonite is recommended to determine the grain size distribution of the material.

The most difficult parameters to control are sometimes the amount of bentonite added to the soil and the thoroughness of mixing. Field CQC and CQA personnel should observe operational practices carefully.

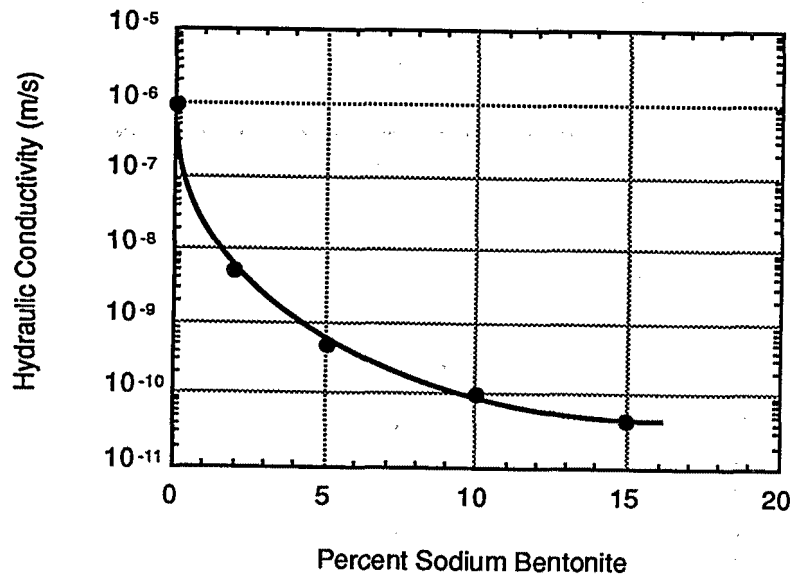

Figure 2.13 - Effect of Addition of Bentonite to Hydraulic Conductivity of Compacted Silty Sand

2.2.2 Molding Water Content

For natural soils, the degree of saturation of the soil liner material at the time of compaction is perhaps the single most important variable that controls the engineering properties of the compacted material. The typical relationship between hydraulic conductivity and molding water content is shown in Fig. 2.14. Soils compacted at water contents less than optimum (*dry of optimum*) tend to have a relatively high hydraulic conductivity; soils compacted at water contents greater than optimum (*wet of optimum*) tend to have a low hydraulic conductivity and low strength. For some soils, the water content relative to the plastic limit (which is the water content of the soil when the soil is at the boundary between being a solid and plastic material) may indicate the degree to which the soil can be compacted to yield low hydraulic conductivity. In general, if the water content is greater than the plastic limit, the soil is in a plastic state and should be capable of being remolded into a low-hydraulic-conductivity material. Soils with water contents dry of the plastic limit will exhibit very little "plasticity" and may be difficult to compact into a low-hydraulic-conductivity mass without delivering enormous compactive energy to the soil. With soil-bentonite mixes, molding water content is usually not as critical as it is for natural soils.

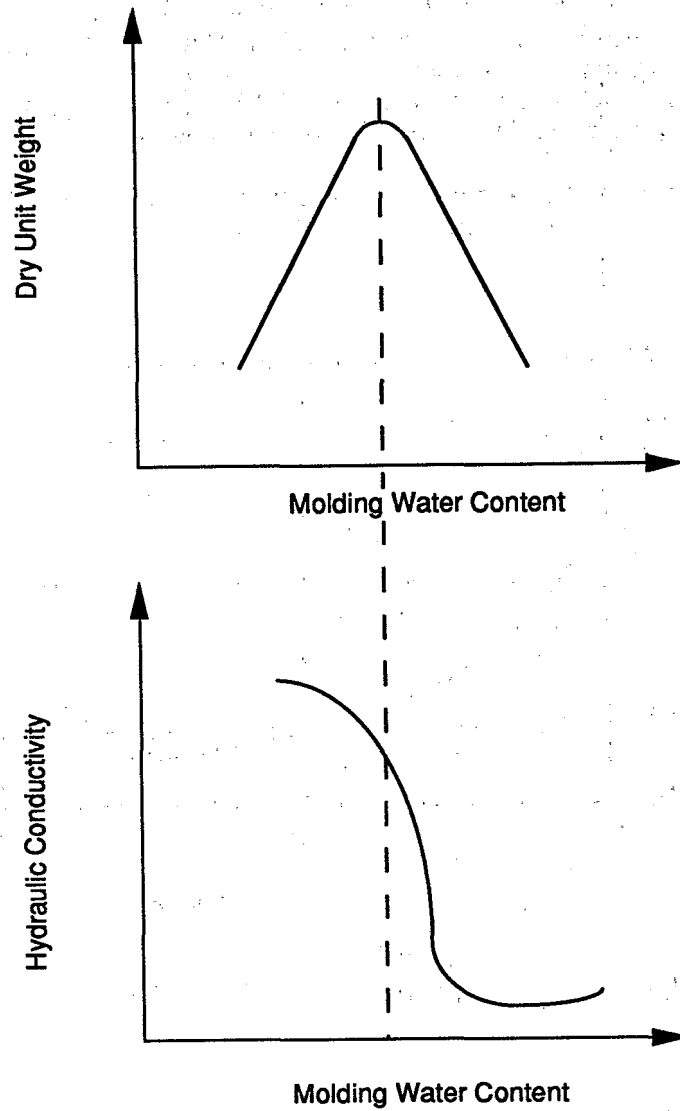

Figure 2.14 - Effect of Molding Water Content on Hydraulic Conductivity

The water content of highly plastic soils is particularly critical. A photograph of a highly plastic soil ($PI = 41\%$) compacted 1% dry of the optimum water content of 17% is shown in Fig. 2.15. Large inter-clod voids are visible; the clods of clay were too dry and hard to be effectively remolded with the compactive effort used. A photograph of a compacted specimen of the same soil moistened to 3% wet of optimum and then compacted is shown in Fig. 2.16. At this water content, the soft soil could be remolded into a homogenous, low-hydraulic-conductivity mass.

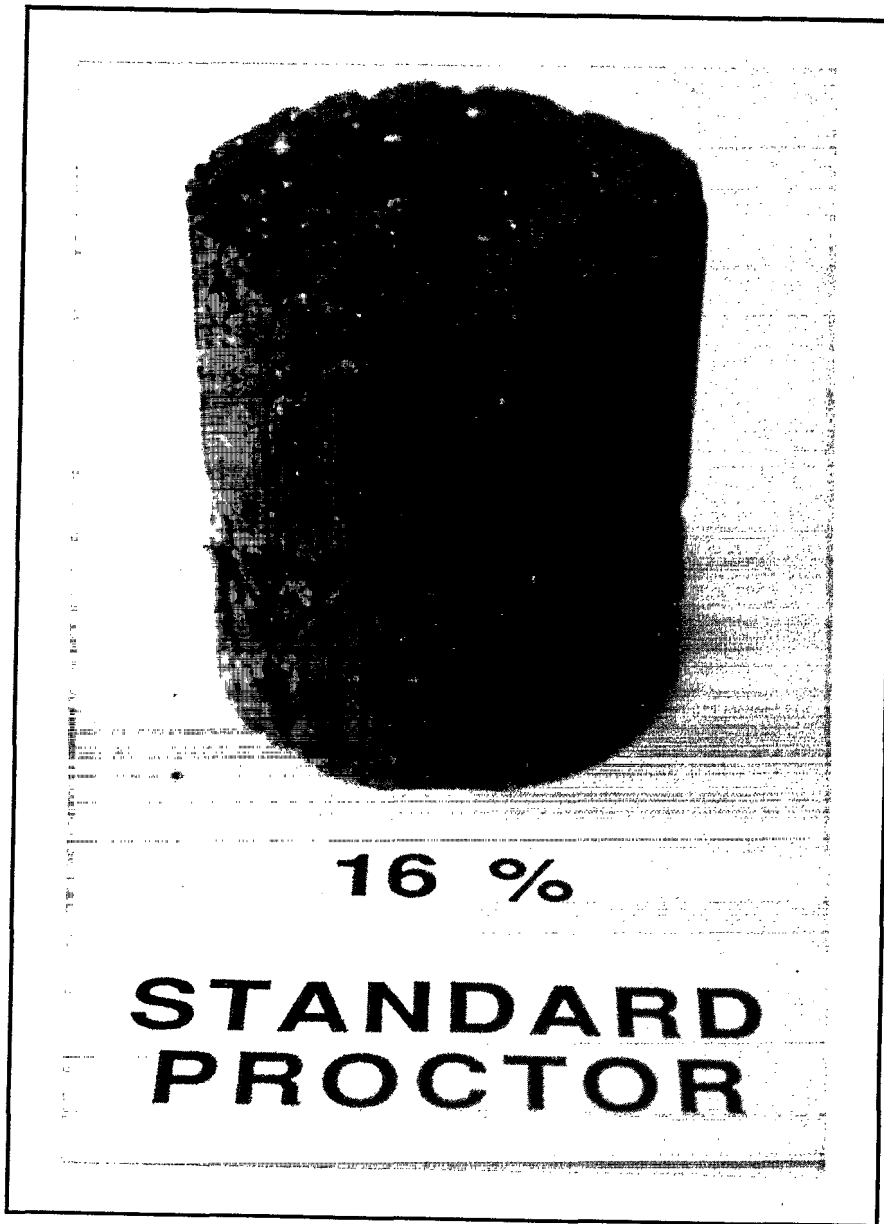

Figure 2.15 - Photograph of Highly Plastic Clay Compacted with Standard Proctor Effort at a Water Content of 16% (1% Dry of Optimum).



Figure 2.16 - Photograph of Highly Plastic Clay Compacted with Standard Proctor Effort at a Water Content of 20% (3% Wet of Optimum).

It is usually preferable to compact the soil wet of optimum to minimize hydraulic conductivity. However, the soil must not be placed at too high a water content. Otherwise, the shear strength may be too low, there may be great risk of desiccation cracks forming if the soil dries, and ruts may form when construction vehicles pass over the liner. It is critically important that CQC and CQA inspectors verify that the water content of the soil is within the range specified in the construction documents.

2.2.3 Type of Compaction

In the laboratory, soil can be compacted in four ways:

1. Impact Compaction: A ram is repeatedly raised and dropped to compact a lift soil into a mold (Fig. 2.17a), e.g., standard and modified Proctor.
2. Static Compaction: A piston compacts a lift of soil with a constant stress (Fig. 2.17b).
3. Kneading Compaction: A “foot” kneads the soil (Fig. 2.17c).
4. Vibratory Compaction: The soil is vibrated to densify the material (Fig. 2.17d).

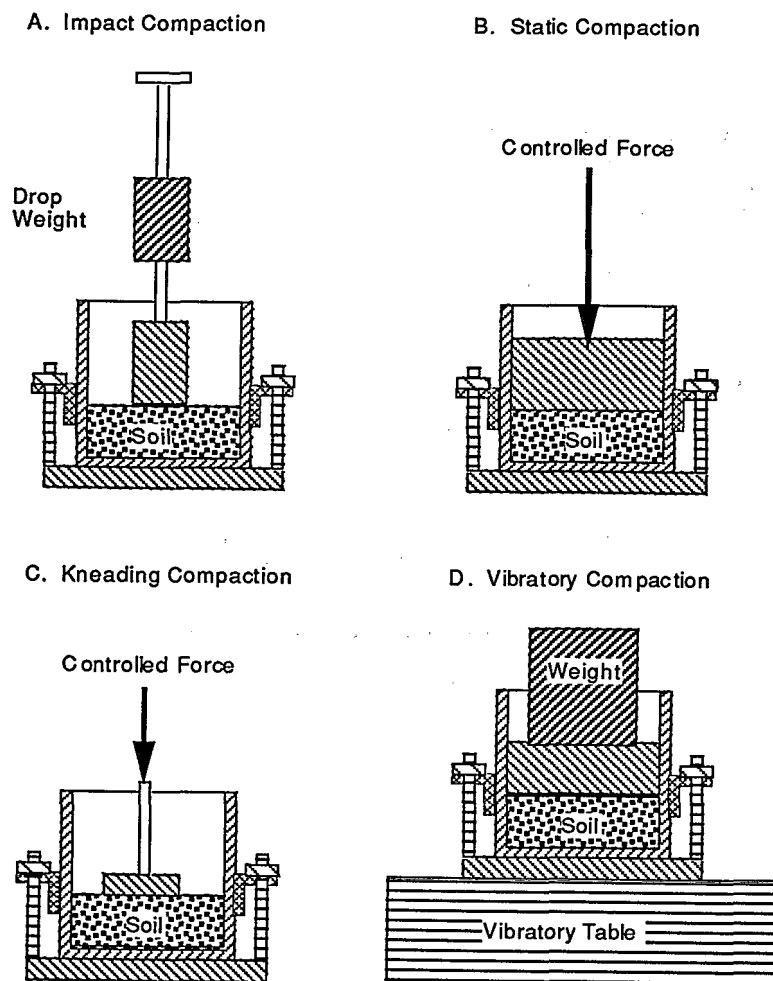

Figure 2.17 - Four Types of Laboratory Compaction Tests

Experience from the laboratory has shown that the type of compaction can affect hydraulic conductivity, e.g., as shown in Fig. 2.18. Kneading the soil helps to break down clods and remold the soil into a homogenous mass that is free of voids or large pores. Kneading of the soil is particularly beneficial for highly plastic soils. For certain bentonite-soil blends that do not form clods, kneading is not necessary. Most soil liners are constructed with “footed” rollers. The “feet” on the roller penetrate into a loose lift of soil and knead the soil with repeated passages of the roller. The dimensions of the feet on rollers vary considerably. Footed rollers with short feet (≈ 75 mm or 3 in.) are called “pad foot” rollers; the feet are said to be “partly penetrating” because the foot is too short to penetrate fully a typical loose lift of soil. Footed rollers with long feet (≈ 200 mm or 8 in.) are often called “sheepsfoot” rollers; the feet fully penetrate a typical loose lift. Figure 2.19 contrasts rollers with partly and fully penetrating feet.

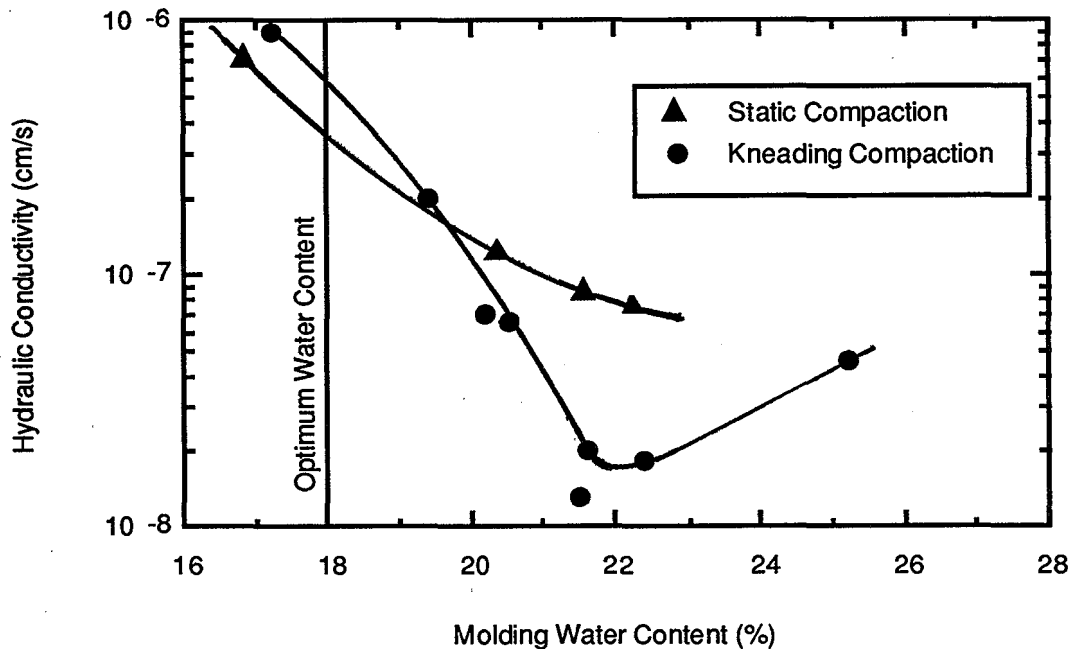

Figure 2.18 - Effect of Type of Compaction on Hydraulic Conductivity (from Mitchell et al., 1965)

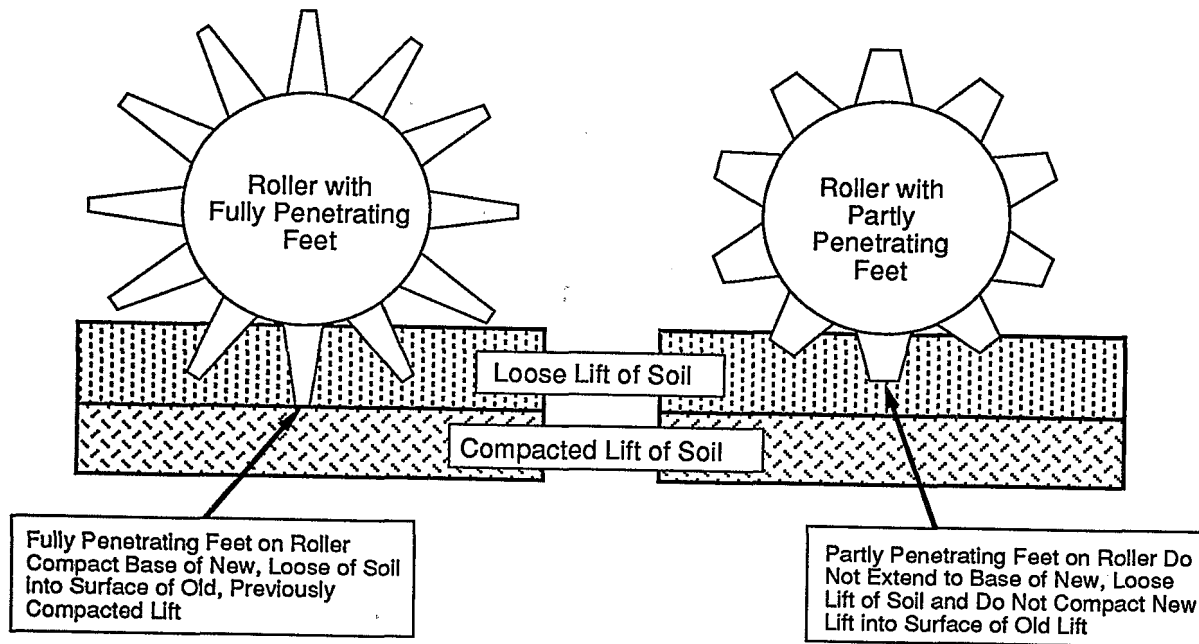

Figure 2.19 - Footed Rollers with Partly and Fully Penetrating Feet

Some construction specifications place limitations on the type of roller that can be used to compact a soil liner. Personnel performing CQC and CQA should be watchful of the type of roller to make sure it conforms to construction specifications. It is particularly important to use a roller with fully penetrating feet if such a roller is required; use of a non-footed roller or pad foot roller would result in less kneading of the soil.

2.2.4 Energy of Compaction

The energy used to compact soil can have an important influence on hydraulic conductivity. The data shown in Fig. 2.20 show that increasing the compactive effort produces soil that has a greater dry unit weight and lower hydraulic conductivity. It is important that the soil be compacted with adequate energy if low hydraulic conductivity is to be achieved.

In the field, compactive energy is controlled by:

1. The weight of the roller and the way the weight is distributed (greater weight produces more compactive energy).
2. The thickness of a loose lift (thicker lifts produce less compactive energy per unit volume of soil).
3. The number of passes of the compactor (more passes produces more compactive energy).

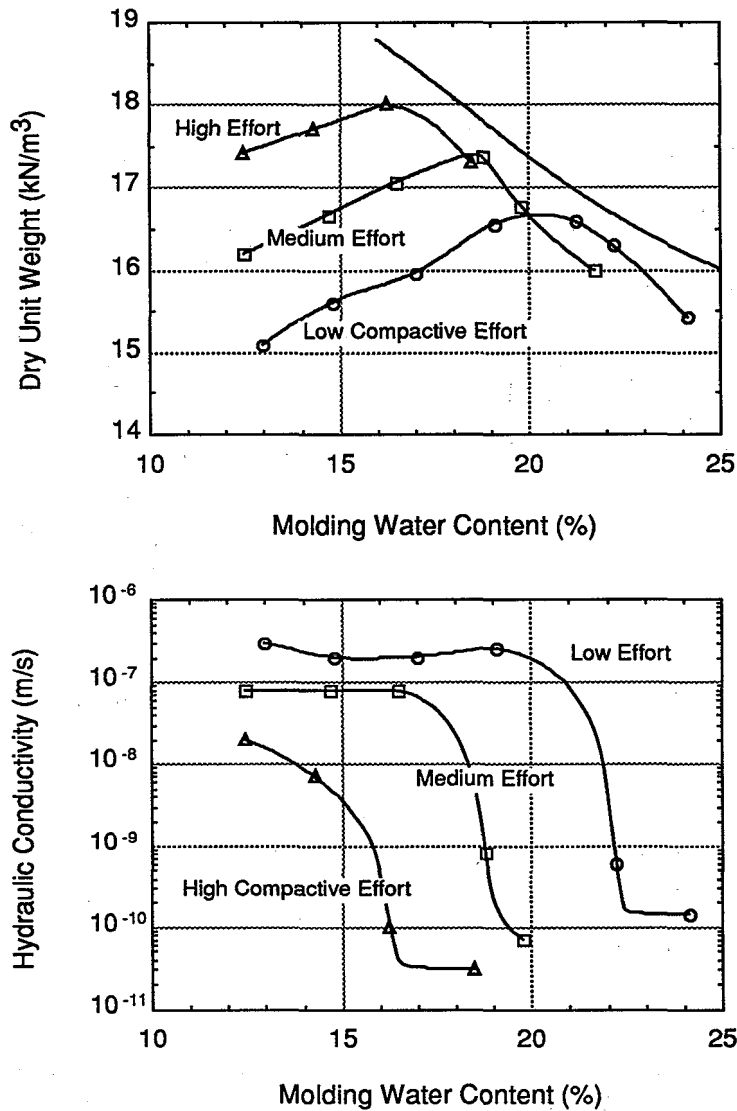

Figure 2.20 - Effect of Compactive Energy on Hydraulic Conductivity (after Mitchell et al., 1965)

Many engineers and technicians assume that percent compaction is a good measure of compactive energy. Indeed, for soils near optimum water content or dry of optimum, percent compaction is a good indicator of compactive energy: if the percent compaction is low, then the compactive energy was almost certainly low. However, for soil compacted wet of optimum,

percent compaction is not a particularly good indicator of compactive energy. This is illustrated by the curves in Fig. 2.21. The same soil is compacted with Compactive Energy A and Energy B (Energy B > Energy A) to develop the compaction curves shown in Fig. 2.21. Next, two specimens are compacted to the same water content ($w_A = w_B$). The dry unit weights are practically identical ($\gamma_{d,A} \approx \gamma_{d,B}$) despite the fact that the energies of compaction were different. Further, the hydraulic conductivity (k) of the specimen compacted with the larger energy (Energy B) has a lower hydraulic conductivity than the specimen compacted with Energy A despite the fact that $\gamma_{d,A} \approx \gamma_{d,B}$. The percent compaction for the two compacted specimens is computed as follows:

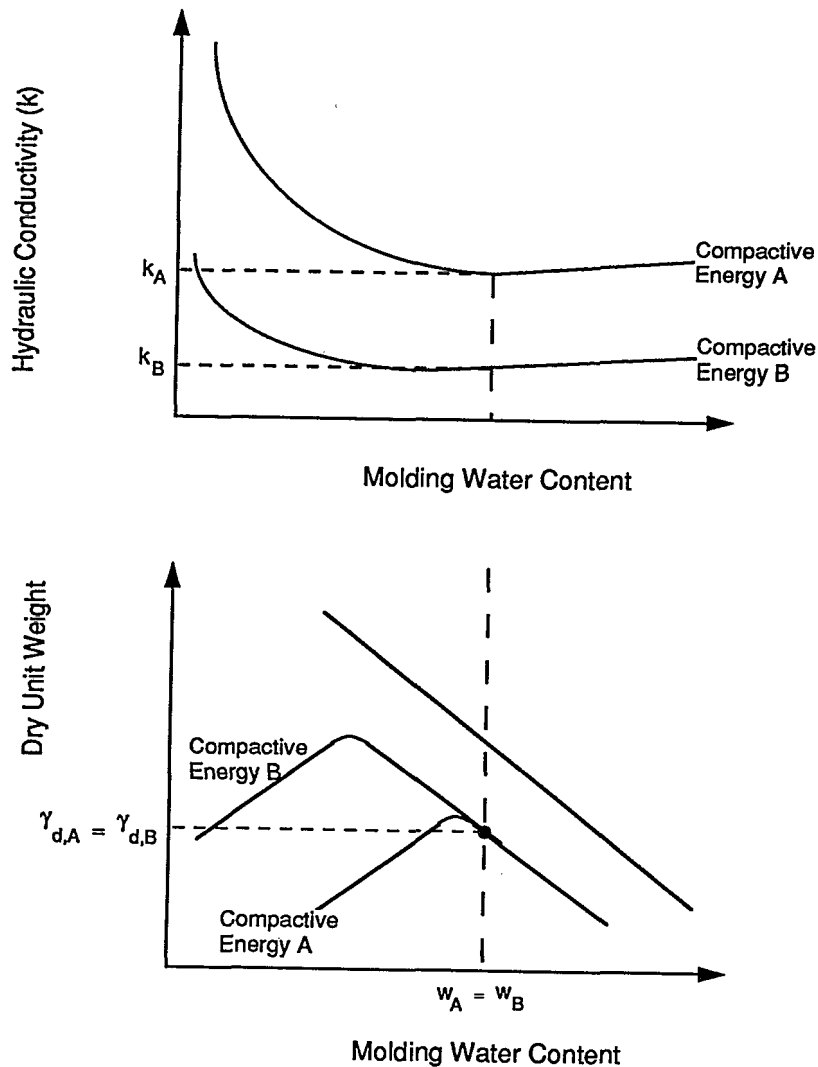

Figure 2.21 - Illustration of Why Dry Unit Weight Is a Poor Indicator of Hydraulic Conductivity for Soil Compacted Wet of Optimum

$$P_A = \gamma_{d,A} / [\gamma_{d,max}]_A \times 100\%$$

$$P_B = \gamma_{d,B} / [\gamma_{d,max}]_B \times 100\%$$

Since $\gamma_{d,A} = \gamma_{d,B}$ but $[\gamma_{d,max}]_B > [\gamma_{d,max}]_A$, then $P_A > P_B$. Thus, based on percent compaction, since $P_A > P_B$, one might assume Soil A was compacted with greater compactive energy than Soil B. In fact, just the opposite is true. CQC and CQA personnel are strongly encouraged to monitor equipment weight, lift thickness, and number of passes (in addition to dry unit weight) to ensure that appropriate compactive energy is delivered to the soil. Some CQC and CQA inspectors have failed to realize that footed rollers towed by a dozer must be filled with liquid to have the intended large weight.

Experience has shown that effective CQC and CQA for soil liners can be accomplished using the line of optimums as a reference. The "line of optimums" is the locus of $(w_{opt}, \gamma_{d,max})$ points for compaction curves developed on the same soil with different compactive energies (Fig. 2.22). The greater the percentage of actual (w, γ_d) points that lie above the line of optimums the better the overall quality of construction (Benson and Boutwell, 1992). Inspectors are encouraged to monitor the percentage of field-measured (w, γ_d) points that lie on or above the line of optimums. If the percentage is less than 80% to 90%, inspectors should carefully consider whether adequate compactive energy is being delivered to the soil (Benson and Boutwell, 1992).

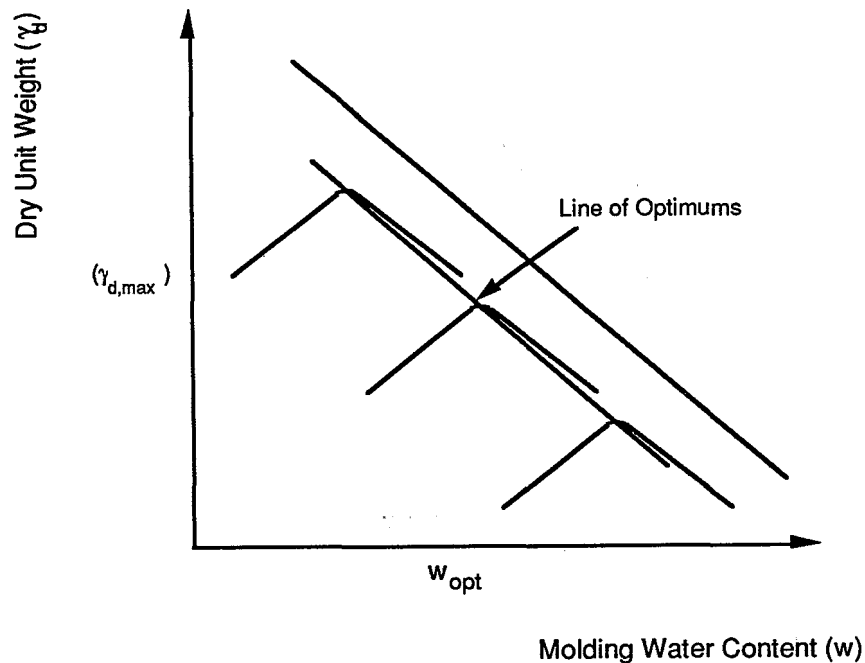

Figure 2.22 - Line of Optimums

2.2.5 Bonding of Lifts

If lifts of soil are poorly bonded, a zone of high hydraulic conductivity will develop at interfaces between lifts. Poorly bonded lift interfaces provide hydraulic connection between more permeable zones in adjacent lifts (Fig. 2.23). It is important to bond lifts together to the greatest extent possible, and to maximize hydraulic tortuosity along lift interfaces, in order to minimize the overall hydraulic conductivity.

Bonding of lifts is enhanced by:

1. Making sure the surface of a previously-compacted lift is rough before placing the new lift of soil (the previously-compacted lift is often scarified with a disc prior to placement of a new lift), which promotes bonding and increased hydraulic tortuosity along the lift interface..
2. Using a fully-penetrating footed roller (the feet pack the base of the new lift into the surface of the previously-compacted lift).

Inspectors should pay particular attention to requirements for scarification and the length of feet on rollers.

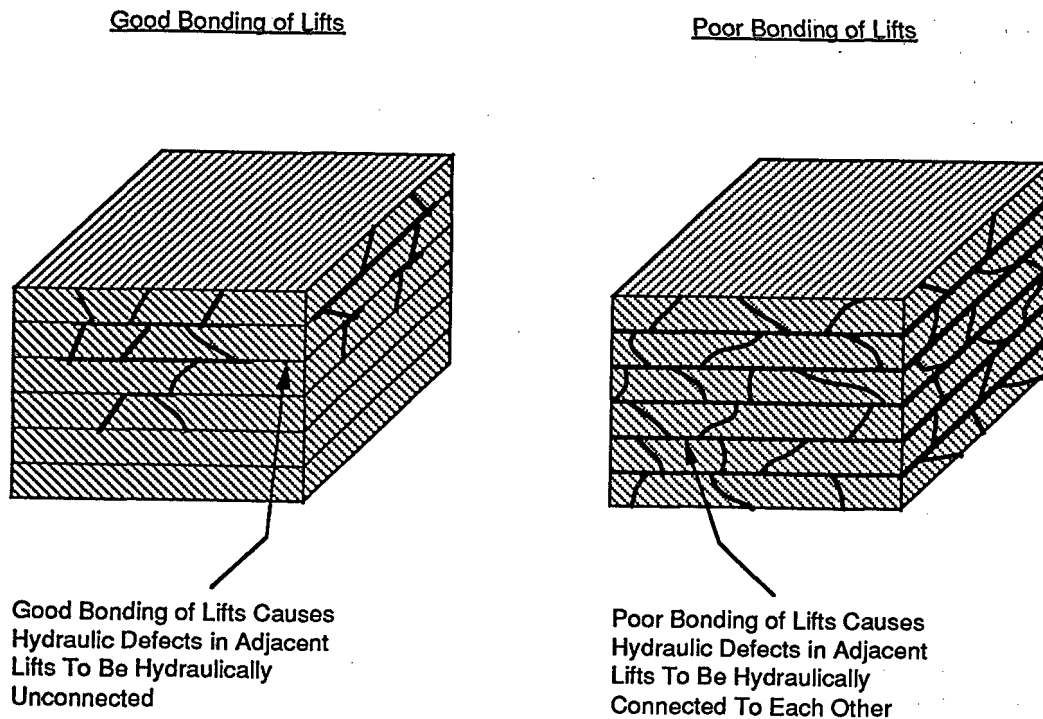

Figure 2.23 - Flow Pathways Created by Poorly Bonded Lifts

2.2.6 Protection Against Desiccation and Freezing

Clay soils shrink when they are dried and, depending on the amount of shrinkage, may crack. Cracks that extend deeper than one lift can be disastrous. Inspectors must be very careful to make sure that no significant desiccation occurs during or after construction. Water content should be measured if there are doubts.

Freezing of a soil liner will cause the hydraulic conductivity to increase. Damage caused by superficial freezing to a shallow depth is easily repaired by rerolling the surface. Deeper freezing is not so easily repaired and requires detailed investigation discussed in Section 2.9.2.3. CQC & CQA personnel should be watchful during periods when freezing temperatures are possible.

2.3 Field Measurement of Water Content and Dry Unit Weight

2.3.1 Water Content Measurement

2.3.1.1 Overnight Oven Drying (ASTM D-2216)

The standard method for determining the water content of a soil is to oven dry the soil overnight in a forced-convection oven at 110°C. This is the most fundamental and most accurate method for determining the water content of a soil. All other methods of measurement are referenced to the value of water content determined with this method.

Were it not for the fact that one has to wait overnight to determine water content with this method, undoubtedly ASTM D-2216 would be the only method of water content measurement used in the CQC and CQA processes for soil liners. However, field personnel cannot wait overnight to make decisions about continuation with the construction process.

2.3.1.2 Microwave Oven Drying (ASTM D-4643)

Soil samples can be dried in a microwave oven to obtain water contents much more quickly than can be obtained with conventional overnight oven drying. The main problem with microwave oven drying is that if the soil dries for too long in the microwave oven, the temperature of the soil will rise significantly above 110°C. If the soil is heated to a temperature greater than 110°C, one will measure a water content that is greater than the water content of the soil determined by drying at 110°C. Overheating the soil drives water out of the crystal structure of some minerals and thereby leads to too much loss of water upon oven drying.

To guard against overdrying the soil, ASTM method D-4643 requires that the soil be dried for three minutes and then weighed. The soil is then dried for an additional minute and reweighed. The process of drying for one minute and weighing the soil prevents overheating of the soil and forces the operator to cease the drying process once the weight of the soil has stabilized.

Under ideal conditions, microwave oven drying can yield water contents that are almost indistinguishable from values measured with conventional overnight oven drying. Problems that are sometimes encountered with microwave oven drying include problems in operating the oven if the soil contains significant metal and occasional problems with samples exploding from expansion of gas in the interior of the sample during microwave oven drying. Because errors can occasionally arise with microwave oven drying, the water content determined with microwave oven drying should be periodically checked with the value determined by conventional over-night oven drying (ASTM D-2216).

2.3.1.3 Direct Heating (ASTM D-4959)

Direct heating of the soil was common practice up until about two decades ago. To dry a soil with direct heating, one typically places a mass of soil into a metallic container (such as a cooking utensil) and then heats the soil over a flame, e.g., a portable cooking stove, until the soil first appears dry. The mass of the soil plus container is then measured. Next, the soil is heated some more and then re-weighed. This process is repeated until the mass ceases to decrease significantly (i.e., to change by < 0.1% or less).

The main problem with direct heating is that if the soil is overheated during drying, the water content that is measured will be too large. Although ASTM D-4959 does not eliminate this problem, the ASTM method does warn the user not to overheat the soil. Because errors can do arise with direct heating, the water content determined with direct heating should be regularly checked with the value determined by conventional over-night oven drying (ASTM D-2216).

2.3.1.4 Calcium Carbide Gas Pressure Tester (ASTM D-4944)

A known mass of moist soil is placed in a testing device and calcium carbide is introduced. Mixing is accomplished by shaking and agitating the soil with the aid of steel balls and a shaking apparatus. A measurement is made of the gas pressure produced. Water content is determined from a calibration curve. Because errors can occasionally arise with gas pressure testing, the water content determined with gas pressure testing should be periodically checked with the value determined by conventional over-night oven drying (ASTM D-2216).

2.3.1.5 Nuclear Method (ASTM D-3017)

The most widely used method of measuring the water content of compacted soil is the nuclear method. Measurement of water content with a nuclear device involves the moderation or thermalization of neutrons provided by a source of fast neutrons. Fast neutrons are neutrons with an energy of approximately 5 MeV. The radioactive source of fast neutrons is embedded in the interior part of a nuclear water content/density device (Fig. 2.24). As the fast neutrons move into the soil, they undergo a reduction in energy every time a hydrogen atom is encountered. A series of energy reductions takes place when a neutron sequentially encounters hydrogen atoms. Finally, after an average of nineteen collisions with hydrogen atoms, a neutron ceases to lose further energy and is said to be a "thermal" neutron with an energy of approximately 0.025 MeV. A detector in the nuclear device senses the number of thermal neutrons that are encountered. The number of thermal neutrons that are encountered over a given period of time is a function of the number of fast neutrons that are emitted from the source and the density of hydrogen atoms in the soil located immediately below the nuclear device. Through appropriate calibration, and with the assumption that the only source of hydrogen in the soil is water, the nuclear device provides a measure of the water content of the soil over an average depth of about 200 mm (8 in.).

There are a number of potential sources of error with the nuclear water content measuring device. The most important potential source of error is extraneous hydrogen atoms not associated with water. Possible sources of hydrogen other than water include hydrocarbons, methane gas, hydrous minerals (e.g., gypsum), hydrogen-bearing minerals (e.g., kaolinite, illite, and montmorillonite), and organic matter in the soil. Under extremely unfavorable conditions the nuclear device can yield water content measurements that are as much as ten percentage points in error (almost always on the high side). Under favorable conditions, measurement error is less than one percent. The nuclear device should be calibrated for site specific soils and changing conditions within a given site.

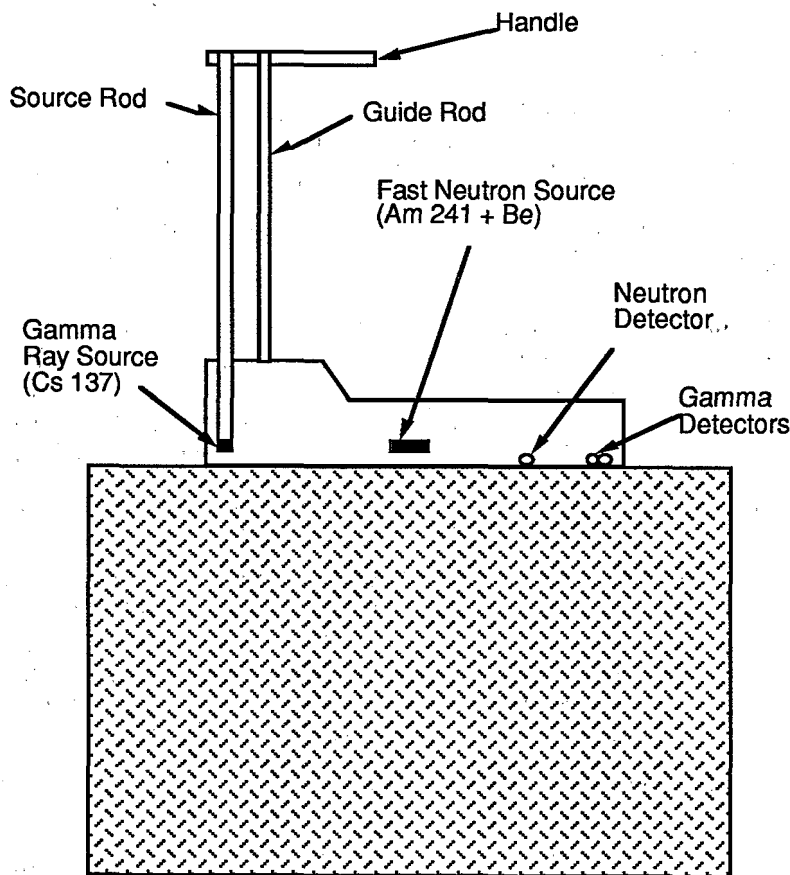

Figure 2.24 - Schematic Diagram of Nuclear Water Content - Density Device

Another potential source of error is the presence of individuals, equipment, or trenches located within one meter of the device (all of which can cause an error). The device must be warmed up for an adequate period of time or the readings may be incorrect. If the surface of the soil is improperly prepared and the device is not sealed properly against a smooth surface, erroneous measurements can result. If the standard count, which is a measure of the intensity of radiation from the source, has not been taken recently an erroneous reading may result. Finally, many nuclear devices allow the user to input a moisture adjustment factor to correct the water content reading by a fixed amount. If the wrong moisture adjustment factor is stored in the device's computer, the reported water content will be in error.

It is very important that the CQC and CQA personnel be well versed in the proper use of nuclear water content measurement devices. There are many opportunities for error if personnel are not properly trained or do not correctly use the equipment. As indicated later, the nuclear device should be checked with other types of equipment to ensure that site-specific variables are not influencing test results. Nuclear equipment may be checked against other nuclear devices (particularly new devices or recently calibrated devices) to minimize potential for errors.

2.3.2 Unit Weight

2.3.2.1 Sand Cone (ASTM D-1556)

The sand cone is a device for determining the volume of a hole that has been excavated into soil. The idea is to determine the weight of sand required to fill a hole of unknown volume. Through calibration, the volume of sand that fills the hole can be determined from the weight of sand needed to fill the hole. A schematic diagram of the sand cone is shown in Fig. 2.25.

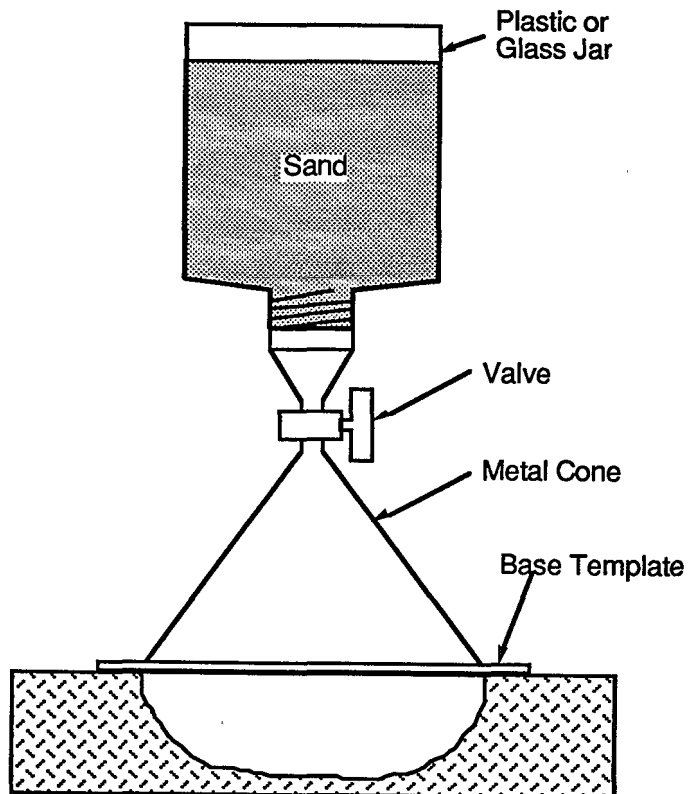

Figure 2.25 - Sand Cone Device

The sand cone is used as follows. First, a template is placed on the ground surface. A circle is scribed along the inside of the hole in the template. The template is removed and soil is excavated from within the area marked by the scribed circle. The soil that is excavated is weighed to determine the total weight (W) of the soil excavated. The excavated soil is oven dried (e.g., with a microwave oven) to determine the water content of the soil. The bottle in a sand cone device is filled with sand and the full bottle is weighed. The template is placed over the hole and the sand cone device is placed on top of the template. A valve on the sand cone device is opened, which allows sand to rain down through the inverted funnel of the device and inside the excavated hole.

When the hole and funnel are filled with sand, the valve is closed and the bottle containing sand is weighed. The difference in weight before and after the hole is dug is calculated. Through calibration, the weight of sand needed to fill the funnel is subtracted, and the volume of the hole is computed from the weight of sand that filled the hole. The total unit weight is calculated by dividing the weight of soil excavated by the computed volume of the excavated hole. The dry unit weight is then calculated from Eq. 2.1.

The sand cone device provides a reliable technique for determining the dry unit weight of the soil. The primary sources of error are improper calibration of the device, excavation of an uneven hole that has sharp edges or overhangs that can produce voids in the sand-filled hole, variations in the sand, excessively infrequent calibrations, contamination of the sand by soil particles if the sand is reused, and vibration as from equipment operating close to the sand cone.

2.3.2.2 Rubber Balloon (ASTM D-2167)

The rubber balloon is similar to the sand cone except that water is used to fill the excavated hole rather than sand. A rubber balloon device is sketched in Fig. 2.26. As with the sand cone test, the test is performed with the device located on the template over the leveled soil. Then a hole is excavated into the soil and the density measuring device is again placed on top of a template at the ground surface. Water inside the rubber balloon device is pressurized with air to force the water into the excavated hole. A thin membrane (balloon) prevents the water from entering the soil. The pressure in the water forces the balloon to conform to the shape of the excavated hole. A graduated scale on the rubber balloon device enables one to determine the volume of water required to fill the hole. The total unit weight is calculated by dividing the known weight of soil excavated from the hole by the volume of water required to fill the hole with the rubber balloon device. The dry unit weight is computed from Eq. 2.1.

The primary sources of error with the rubber balloon device are improper excavation of the hole (leaving small zones that cannot be filled by the pressurized balloon), excessive pressure that causes local deformation of the adjacent soil, rupture of the balloon, and carelessness in operating the device (e.g., not applying enough pressure to force the balloon to fill the hole completely).

2.3.2.3 Drive Cylinder (ASTM D-2937)

A drive cylinder is sketched in Fig. 2.27. A drop weight is used to drive a thin-walled tube sampler into the soil. The sampler is removed from the soil and the soil sample is trimmed flush to the bottom and top of the sampling tube. The soil-filled tube is weighed and the known weight of the sampling tube itself is subtracted to determine the gross weight of the soil sample. The dimensions of the sample are measured to enable calculation of volume. The unit weight is calculated by dividing the known weight by the known volume of the sample. The sample is oven dried (e.g., in a microwave oven) to determine water content. The dry unit weight is computed from Eq. 2.1.

The primary problems with the drive cylinder are sampling disturbance caused by rocks or stones in the soil, densification of the soil caused by compression resulting from driving of the tube into the soil, and nonuniform driving of the tube into the soil. The drive cylinder method is not recommended for stony or gravelly soils. The drive cylinder method works best for relatively soft, wet clays that do not tend to densify significantly when the tube is driven into the soil and for soils that are free of gravel or stones. However, even under favorable circumstances, densification of the soil caused by driving the ring into the soil can cause an increase in total unit weight of 2 to 5 pcf (0.3 to 0.8 kN/m³).

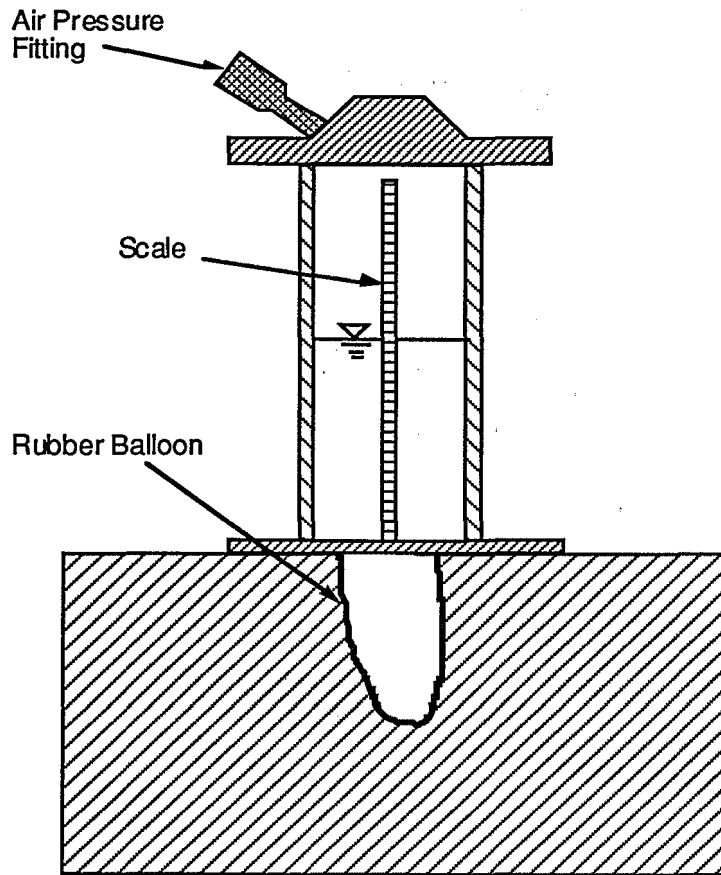

Figure 2.26 - Schematic Diagram of Rubber Balloon Device

2.3.2.4 Nuclear Method (ASTM D-2922)

Unit weight can be measured with a nuclear device operated in two ways as shown in Fig. 2.28. The most common usage is called *direct transmission* in which a source of gamma radiation is lowered down a hole made into the soil to be tested (Fig. 2.28a). Detectors located in the nuclear density device sense the intensity of gamma radiation at the ground surface. The intensity of gamma radiation detected at the surface is a function of the intensity of gamma radiation at the source and the total unit weight of the soil material. The second mode of operation of the nuclear density device is called *backscattering*. With this technique the source of gamma radiation is located at the ground surface (Fig. 2.28b). The intensity of gamma radiation detected at the surface is a function of the density of the soil as well as the radioactivity of the source. With the backscattering technique, the measurement is heavily dependent upon the density of the soil within the upper 25 to 50 mm of soil. The direct transmission method is the recommended technique for soil liners because direct transmission provides a measurement averaged over a greater depth than backscattering.

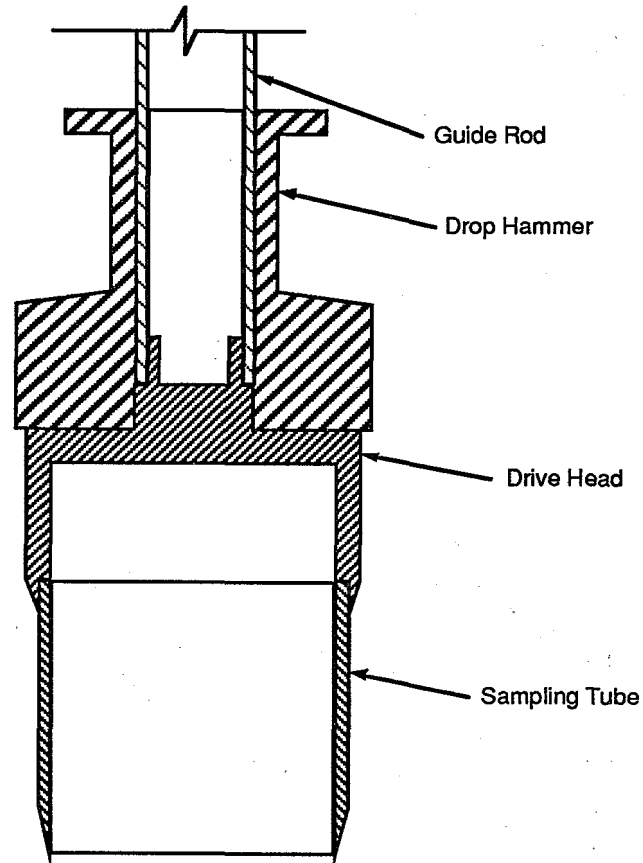
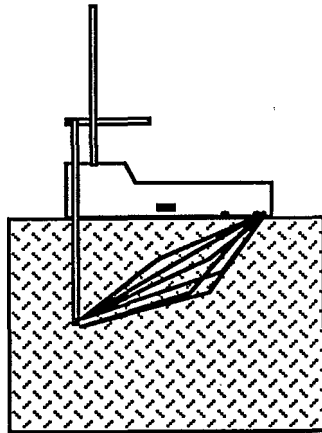

Figure 2.27 - Schematic Diagram of Drive Ring

The operation of a nuclear density device in the direct transmission mode is as follows. First, the area to be tested is smoothed, and a hole is made into the soil liner material by driving a rod (called the *drive rod*) into the soil. The diameter of the hole is approximately 25 mm (1 in.) and the depth of the hole is typically 50 mm (2 in.) greater than the depth to which the gamma radiation source will be lowered below the surface. The nuclear device is then positioned with the source rod directly over the hole in the soil liner material. The source rod is then lowered to a depth of approximately 50 mm (2 in.) above the base of the hole. The source is then pressed against the surface of the hole closest to the detector by pulling on the nuclear device and forcing the source to bear against the side of the hole closest to the detector. The intent is to have good contact between the source and soil along a direct line from source to detector. The intensity of radiation at the detector is measured for a fixed period of time, e.g., 30 or 60 s. The operator can select the period of counting. The longer the counting period, the more accurate the measurement. However, the counting period cannot be extended too much because productivity will suffer.

(A) Direct Transmission



(B) Backscattering

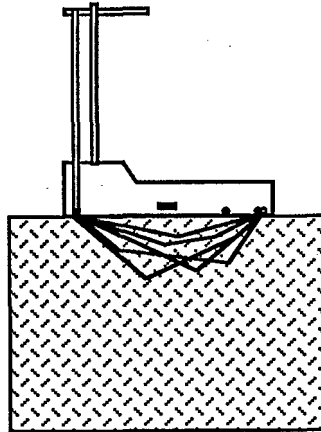

Figure 2.28 - Measurement of Density with Nuclear Device by (a) Direct Transmission and (B) Backscattering

After total unit weight has been determined, the measured water content is used to compute dry unit weight (Eq. 2.1). The potential sources of error with the nuclear device are fewer and less significant in the density-measuring mode compared to the water content measuring mode. The most serious potential source of error is improper use of the nuclear density device by the operator. One gross error that is sometimes made is to drive the source rod into the soil rather than inserting the source rod into a hole that had been made earlier with the drive rod. Improper separation of the source from the base of the hole, an inadequate period of counting, inadequate warm-up, spurious sources of gamma radiation, and inadequate calibration are other potential sources of error.

2.4 Inspection of Borrow Sources Prior to Excavation

2.4.1 Sampling for Material Tests

In order to determine the properties of the borrow soil, samples are often obtained from the potential borrow area for laboratory analysis prior to actual excavation but as part of the construction contract. Samples may be obtained in several ways. One method of sampling is to drill soil borings and recover samples of soil from the borings. This procedure can be very effective in identifying major strata and substrata within the borrow area. Small samples obtained from the borings are excellent for index property testing but often do not provide a very good indication of subtle stratigraphic changes in the borrow area. Test pits excavated into the borrow soil with a backhoe, frontend loader, or other excavation equipment can expose a large cross-section of the borrow soil. One can obtain a much better idea of the variability of soil in the potential borrow area by examining exposed cuts rather than viewing small soil samples obtained from borings.

Large bulk samples of soil are required for compaction testing in the laboratory. Small samples of soil taken with soil sampling devices do not provide a sufficient volume of soil for laboratory compaction testing. Some engineers combine samples of soil taken at different depths or from different borings to produce a composite sample of adequate volume. This technique is not recommended because a degree of mixing takes place in forming the composite laboratory test sample that would not take place in the field. Other engineers prefer to collect material from auger borings for use in performing laboratory compaction tests. This technique is likewise not recommended without careful borrow pit control because vertical mixing of material takes place during auguring in a way that would not be expected to occur in the field unless controlled vertical cuts are made. The best method for obtaining large bulk samples of material for laboratory compaction testing is to take a large sample of material from one location in the borrow source. A large, bulk sample can be taken from the wall or floor of a test pit that has been excavated into the borrow area. Alternatively, a large piece of drilling equipment such as a bucket auger can be used to obtain a large volume of soil from a discreet point in the ground.

2.4.2. Material Tests

Samples of soil must be taken for laboratory testing to ensure conformance with specifications for parameters such as percentage fines and plasticity index. The samples are sometimes taken in the borrow pit, are sometimes taken from the loose lift just prior to compaction, and are sometimes taken from both. If samples are taken from the borrow area, CQA inspectors track the approximate volumes of soil excavated and sample at the frequency prescribed in the CQA plan. Sometimes borrow-source testing is performed prior to issuing of a contract to purchase the borrow material. A CQA program cannot be implemented for work already completed. The CQA personnel will have ample opportunity to check the properties of soil materials later during excavation and placement of the soils. If the CQA personnel for a project did not observe borrow soil testing, the CQA personnel should review the results of borrow soil testing to ensure that the required tests have been performed. Additional testing of the borrow material may be required during excavation of the material.

The material tests that are normally performed on borrow soil are water content, Atterberg limits, particle size distribution, compaction curve, and hydraulic conductivity (Table 2.2). Each of these tests is discussed below.

Table 2.2 - Materials Tests

| Parameter | ASTM Test Method | Title of ASTM Test |
|---|------------------|--|
| Water Content | D-2216 | Laboratory Determination of Water (Moisture) Content of Soil and Rock |
| | D-4643 | Determination of Water (Moisture) Content of Soil by the Microwave Oven Method |
| | D-4944 | Field determination of Water (Moisture) Content of Soil by the Calcium Carbide Gas Pressure Tester Method |
| | D-4959 | Determination of Water (Moisture) Content by Direct Heating Method |
| Liquid Limit, Plastic Limit, & Plasticity Index | D-4318 | Liquid Limit, Plastic Limit, and Plasticity Index of Soils |
| Particle Size Distribution | D-422 | Particle Size Analysis of Soil |
| Compaction Curve | D-698 | Moisture-Density Relations for Soils and Soil-Aggregate Mixtures Using 5.5-lb. (2.48-kg) Rammer and 12-in. (305-mm) Drop |
| | D-1557 | Moisture-Density Relations for Soils and Soil-Aggregate Mixtures Using 10-lb. (4.54-kg) Rammer and 18-in. (457-mm) Drop |
| Hydraulic Conductivity | D-5084 | Measurement of Hydraulic Conductivity of Saturated Porous Materials Using A Flexible Wall Permeameter |

2.4.2.1 Water Content

It is important to know the water content of the borrow soils so that the need for wetting or drying the soil prior to compaction can be identified. The water content of the borrow soil is normally measured following the procedures outlined in ASTM D-2216 if one can wait overnight for results. If not, other test methods described in Section 2.3.1 and listed in Table 2.2 can be used to produce results faster.

2.4.2.2 Atterberg Limits

Construction specifications for compacted soil liners often require a minimum value for the liquid limit and/or plasticity index of the soil. These parameters are measured in the laboratory with the procedures outlined in ASTM D-4318.

2.4.2.3 Particle Size Distribution

Construction specifications for soil liners often place limits on the minimum percentage of fines, the maximum percentage of gravel, and in some cases the minimum percentage of clay. Particle size analysis is performed following the procedures in ASTM D-422. Normally the requirements for the soil material are explicitly stated in the construction specifications. An experienced inspector can often judge the percentage of fine material and the percentage of sand or gravel in the soil. However, compliance with specifications is best documented by laboratory testing.

2.4.2.4 Compaction Curve

Compaction curves are developed utilizing the method of laboratory compaction testing required in the construction specifications. Standard compaction (ASTM D-698) and modified compaction (ASTM D-1557) are two common methods of laboratory compaction specified for soil liners. However, other compaction methods (particularly those unique to state highway or transportation departments) are sometimes specified.

Great care should be taken to follow the procedures for soil preparation outlined in the relevant test method. In particular, the drying of a cohesive material can change the Atterberg limits as well as the compaction characteristics of the soil. If the test procedure recommends that the soil not be dried, the soil should not be dried. Also, care must be taken when sieving the soil not to remove clods of cohesive material. Rather, clods of soil retained on a sieve should be broken apart by hand if necessary to cause them to pass through the openings of the sieve. Sieves should only be used to remove stones or other large pieces of material following ASTM procedures.

2.4.2.5 Hydraulic Conductivity

The hydraulic conductivity of compacted samples of borrow material may be measured periodically to verify that the soil liner material can be compacted to achieve the required low hydraulic conductivity. Several methods of laboratory permeation are available, and others are under development. ASTM D-5084 is the only ASTM procedure currently available. Care should be taken not to apply excessive effective confining stress to test specimens. If no value is specified in the CQA plan, a maximum effective stress of 35 kPa (5 psi) is recommended for both liner and cover systems.

Care should be taken to prepare specimens for hydraulic conductivity testing properly. In addition to water content and dry unit weight, the method of compaction and the compactive energy can have a significant influence on the hydraulic conductivity of laboratory-compacted soils. It is particularly important not to deliver too much compactive energy to attain a desired dry unit weight. The purpose of the hydraulic conductivity test is to verify that borrow soils can be compacted to the desired hydraulic conductivity using a reasonable compactive energy.

No ASTM compaction method exists for preparation of hydraulic conductivity test specimens. The following procedure is recommended:

1. Obtain a large, bulk sample of representative material with a mass of approximately 20 kg.
2. Develop a laboratory compaction curve using the procedure specified in the construction specifications for compaction control, e.g., ASTM D-698 or D-1557.
3. Determine the target water content (w_{target}) and dry unit weight ($\gamma_{d,\text{target}}$) for the hydraulic conductivity test specimen. The value of w_{target} is normally the lowest acceptable water content and $\gamma_{d,\text{target}}$ is normally the minimum acceptable dry unit weight (Fig. 2.29).
4. Enough soil to make several test specimens is mixed to w_{target} . The compaction procedure used in Step 2 is used to prepare a compacted specimen, except that the energy of compaction is reduced, e.g., by reducing the number of drops of the ram per lift. The dry unit weight (γ_d) is determined. If $\gamma_d \approx \gamma_{d,\text{target}}$, the compacted specimen may be used for hydraulic conductivity testing. If $\gamma_d \neq \gamma_{d,\text{target}}$, then another test specimen is prepared with a larger or smaller (as appropriate) compactive energy. Trial and error preparation of test specimens is repeated until $\gamma_d \approx \gamma_{d,\text{target}}$. The procedure is illustrated in Fig. 2.29. The actual compactive effort should be documented along with hydraulic conductivity.
5. Atterberg limits and percentage fines should be determined for each bulk sample. Water content and dry density should be reported for each compacted specimen.

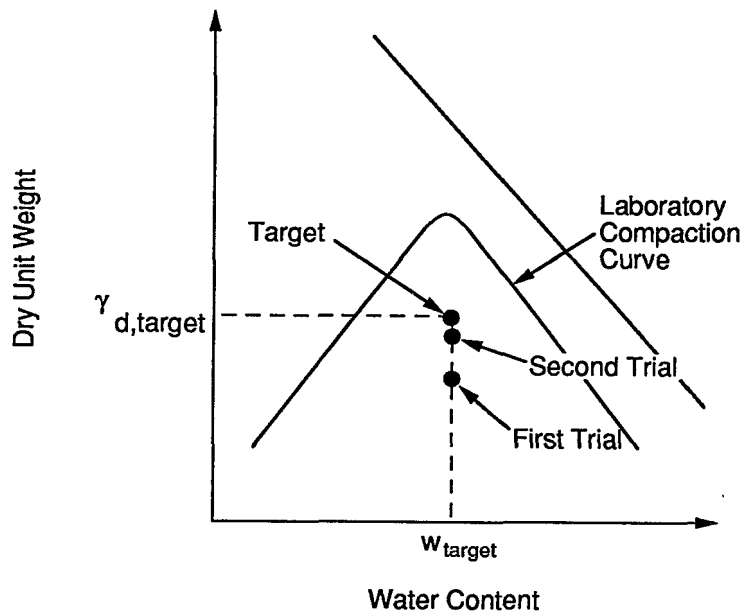

Figure 2.29 - Recommended Procedure for Preparation of a Test Specimen Using Variable (But Documented) Compactive Energy for Each Trial

2.4.2.6 Testing Frequency

The CQA plan should stipulate the frequency of testing. Recommended minimum values are shown in Table 2.3. The tests listed in Table 2.3 are normally performed prior to construction as part of the characterization of the borrow source. However, if time or circumstances do not permit characterization of the borrow source prior to construction, the samples for testing are obtained during excavation or delivery of the soil materials.

Table 2.3 - Recommended Minimum Testing Frequencies for Investigation of Borrow Source

| Parameter | Frequency |
|------------------------|--|
| Water Content | 1 Test per 2000 m ³ or Each Change in Material Type |
| Atterberg Limits | 1 Test per 5000 m ³ or Each Change in Material Type |
| Percentage Fines | 1 Test per 5000 m ³ or Each Change in Material Type |
| Percent Gravel | 1 Test per 5000 m ³ or Each Change in Material Type |
| Compaction Curve | 1 Test per 5000 m ³ or Each Change in Material Type |
| Hydraulic Conductivity | 1 Test per 10,000 m ³ or Each Change in Material Type |

Note: 1 yd³ = 0.76 m³

2.5 Inspection during Excavation of Borrow Soil

It is strongly recommended that a qualified inspector who reports directly to the CQA engineer observe all excavation of borrow soil in the borrow pit. Often the best way to determine whether deleterious material is present in the borrow soil is to observe the excavation of the soil directly.

A key factor for inspectors to observe is the plasticity of the soil. Experienced technicians can often determine whether or not a soil has adequate plasticity by carefully examining the soil in the field. A useful practice for field identification of soils is ASTM D-2488, "Description and Identification of Soils (Visual-Manual Procedure)." The following procedure is used for identifying clayey soils.

- **Dry strength:** The technician selects enough soil to mold into a ball about 25 mm (1 in.) in diameter. Water is added if necessary to form three balls that each have a diameter of about 12 mm (1/2 in.). The balls are allowed to dry in the sun. The strength of the dry balls is evaluated by crushing them between the fingers. The dry strength is described with the criteria shown in Table 2.4. If the dry strength is none or low, inspectors should be alerted to the possibility that the soil lacks adequate plasticity.
- **Plasticity:** The soil is moistened or dried so that a test specimen can be shaped into an elongated pat and rolled by hand on a smooth surface or between the palms into a thread about 3 mm (1/8 in.) in diameter. If the sample is too wet to roll easily it should be spread into a thin layer and allowed to lose some water by evaporation. The sample threads are re-rolled repeatedly until the thread crumbles at a diameter of about 3 mm (1/8 in.). The thread will crumble at a diameter of 3 mm when the soil is near the plastic limit. The plasticity is described from the criteria shown in Table 2.5, based upon observations made during the toughness test. Non-plastic soils are usually unsuitable for use as soil liner materials without use of amendments such as bentonite.

Table 2.4 - Criteria for Describing Dry Strength (ASTM D-2488)

| Description | Criteria |
|-------------|--|
| None | The dry specimen crumbles into powder with mere pressure of handling |
| Low | The dry specimen crumbles into powder with some finger pressure |
| Medium | The dry specimen breaks into pieces or crumbles with considerable finger pressure |
| High | The dry specimen cannot be broken with finger pressure. Specimen will break into pieces between thumb and a hard surface |
| Very High | The dry specimen cannot be broken between the thumb and a hard surface |

Table 2.5 - Criteria for Describing Plasticity (ASTM D-2488)

| Description | Criteria |
|-------------|---|
| Nonplastic | A 3 mm (1/8-in.) thread cannot be rolled at any water content |
| Low | The thread can barely be rolled and the lump cannot be formed when drier than the plastic limit |
| Medium | A thread is easy to roll and not much time is required to reach the plastic limit. The thread cannot be rerolled after reaching the plastic limit. The lump crumbles when drier than the plastic limit |
| High | It takes considerable time rolling and kneading to reach the plastic limit. The thread can be rerolled several times after reaching the plastic limit. The lump can be formed without crumbling when drier than the plastic limit |

2.6 Preprocessing of Materials

Some soil liner materials are ready to be used for final construction immediately after they are excavated from the borrow pit. However, most materials require some degree of processing prior to placement and compaction of the soil.

2.6.1 Water Content Adjustment

Soils that are too wet must first be dried. If the water content needs to be reduced by no more than about three percentage points, the soil can be dried after it has been spread in a loose lift just prior to compaction. If the water content must be reduced by more than about 3 percentage points, it is recommended that drying take place in a separate processing area. The reason for drying in a separate processing area is to allow adequate time for the soil to dry uniformly and to facilitate mixing of the material during drying. The soil to be dried is spread in a lift about 225 to 300 mm (9 to 12 in.) thick and allowed to dry. Water content is periodically measured using one or more of the methods listed in Table 2.2. The contractor's CQC personnel should check the soil periodically to determine when the soil has reached the proper water content.

The CQA inspectors should check to be sure that the soil is periodically mixed with a disc or rototiller to ensure uniform drying. The soil cannot be considered to be ready for placement and compaction unless the water is uniformly distributed; water content measurements alone do not ensure that water is uniformly distributed within the soil.

If the soil must be moistened prior to compaction, the same principles discussed above for drying apply; water content adjustment in a separate preprocessing area is recommended if the water content must be increased by more than about 3 percentage points. Inspectors should be careful to verify that water is distributed uniformly to the soil (a spreader bar on the back of a water truck is the recommended device for moistening soil uniformly), that the soil is periodically mixed with a disc or rototiller, and that adequate time has been allowed for uniform hydration of the soil. If the water content is increased by more than three percentage points, at least 24 to 48 hours would normally be required for uniform absorption of water and hydration of soil particles. The construction specifications may limit the type of water that can be used; in some cases, contaminated water, brackish water, or sea water is not allowed.

2.6.2 Removal of Oversize Particles

Oversized stones and rocks should be removed from the soil liner material. Stones and rocks interfere with compaction of the soil and may create undesirable pathways for fluid to flow through the soil liner. The construction specifications should stipulate the maximum allowable size of particles in the soil liner material.

Oversized particles can be removed with mechanical equipment (e.g., large screens) or by hand. Inspectors should examine the loose lift of soil after the contractor has removed oversized particles to verify that oversized particles are not present. Sieve analyses alone do not provide adequate assurance that oversized materials have been removed -- careful visual inspection for oversized material should be mandatory.

2.6.3 Pulverization of Clods

Some specifications for soil liners place limitations on the maximum size of chunks or clods of clay present in the soil liner material. Discs, rototillers, and road recyclers are examples of mechanical devices that will pulverize clods in a loose lift. Visual inspection of the loose lift of material is normally performed to ensure that clods of soil have been pulverized to the extent required in the construction specifications. Inspectors should be able to visually examine the entire surface of a loose lift to determine whether clods have been adequately processed. No standard method exists for determining clod size. Inspectors normally measure the dimensions of an individual clod with a ruler.

2.6.4 Homogenizing Soils

CQC and CQA are very difficult to perform for heterogeneous materials. It may be necessary to blend and homogenize soils prior to their use in constructing soil liners in order to maintain proper CQC and CQA. Soils can be blended and homogenized in a pugmill. The best way to ensure adequate mixing of materials is through visual inspection of the mixing process itself.

2.6.5 Bentonite

Bentonite is a common additive to soil liner materials that do not contain enough clay to achieve the desired low hydraulic conductivity. Inspectors must ensure that the bentonite being used for a project is in conformance with specifications (i.e., is of the proper quality and gradation) and that the bentonite is uniformly mixed with soil in the required amounts.

The parameters that are specified for the bentonite quality vary considerably from project to project. The construction specifications should stipulate the criteria to be met by the bentonite and

the relevant test methods. The quality of bentonite is usually measured with some type of measurement of water adsorption ability of the clay. Direct measurement of water adsorption can be accomplished using the plate water adsorption test (ASTM E-946). This test is used primarily in the taconite iron ore industry to determine the effectiveness of bentonite, which is used as a binder during the pelletizing process to soak up excess water in the ore. Brown (1992) reports that thousands of plate water adsorption tests have been performed on bentonite, but experience has been that the test is time consuming, cumbersome, and extremely sensitive to variations in the test equipment and test conditions. The plate water adsorption test is not recommended for CQC/CQA of soil liners.

Simple, alternative tests that provide an indirect indication of water adsorption are available. One indirect test for water adsorption is measurement of Atterberg (liquid and plastic) limits via ASTM D-4318. The higher the quality of the bentonite, the higher the liquid limit and plasticity index. Although liquid and plastic limits tests are very common for natural soils, they have not been frequently used as indicators of bentonite quality in the bentonite industry. A commonly-used test in the bentonite industry is the free swell test. The free swell test is used to determine the amount of swelling of bentonite when bentonite is exposed to water in a glass beaker. Unfortunately, there is currently no ASTM test for determining free swell of bentonite, although one is under development. Until such time as an ASTM standard is developed, the bentonite supplier may be consulted for a suggested testing procedure.

The liquid limit test and free swell test are recommended as the principal quality control tests for the quality of bentonite being used on a project. There are no widely accepted cutoff values for the liquid limit and free swell. However, the following is offered for the information of CQC and CQA inspectors. The liquid limit of calcium bentonite is frequently in the range of 100 to 150%. Sodium bentonite of medium quality is expected to have a liquid limit of approximately 300 to 500%. High-quality sodium bentonite typically has a liquid limit in the range of about 500 to 700%. According to Brown (1992), calcium bentonites usually have a free swell of less than 6 cc. Low-grade sodium bentonites typically have a free swell of 8 - 15 cc. High-grade bentonites often have free swell values in the range of 18 to 28 cc. If high-grade sodium bentonite is to be used on a project, inspectors should expect that the liquid limit will be $\geq 500\%$ and the free swell will be ≥ 18 cc.

The bentonite must usually also meet gradational requirements. The gradation of the dry bentonite may be determined by carefully sieving the bentonite following procedures outlined in ASTM D-422. The CQA inspector should be particularly careful to ensure that the bentonite has been pulverized to the extent required in the construction specifications. The degree of pulverization is frequently overlooked. Finely-ground, powdered bentonite will behave differently when blended into soil than more coarsely ground, granular bentonite. CQC/CQA personnel should be particularly careful to make sure that the bentonite is sufficiently finely ground and is not delivered in too coarse a form (per project specifications); sieve tests on the raw bentonite received at a job site are recommended to verify gradation of the bentonite.

The bentonite supplier is expected to certify that the bentonite meets the specification requirements. However, CQA inspectors should perform their own tests to ensure compliance with the specifications. The recommended CQA tests and testing frequencies for bentonite quality and gradation are summarized in Table 2.6.

Table 2.6 - Recommended Tests on Bentonite to Determine Bentonite Quality and Gradation

| Parameter | Frequency | Test Method |
|-----------------------------|--------------------------------------|---|
| Liquid Limit | 1 per Truckload or 2 per Rail Car | ASTM D-4318, "Liquid Limit, Plastic Limit, and Plasticity Index of Soils" |
| Free Swell | 1 per Truckload or 2 per Rail Car | No Standard Procedure Is Available |
| Grain Size of Dry Bentonite | 1 per Truckload or 2 per Rail Car | ASTM D-422, "Particle Size Analysis of Soil" |

2.6.5.1 Pugmill Mixing

A pugmill is a device for mixing dry materials. A schematic diagram of a typical pugmill is shown in Fig. 2.30. A conveyor belt feeds soil into a mixing unit, and bentonite drops downward into the mixing unit. The materials are mixed in a large box that contains rotating rods with mixing paddles. Water may be added to the mixture in the pugmill, as well.

The degree of automation of pugmills varies considerably. The most sophisticated pugmills have computer-controlled devices to monitor the amounts of the ingredients being mixed. CQA personnel should monitor the controls on the mixing equipment.

2.6.5.2 In-Place Mixing

An alternative mixing technique is to spread the soil in a loose lift, distribute bentonite on the surface, and mix the bentonite and soil using a rototiller or other mixing equipment. There are several potential problems with in-place mixing. The mixing equipment may not extend to an adequate depth and may not fully mix the loose lift of soil with bentonite. Alternatively, the mixing device may dig too deeply into the ground and actually mix the loose lift in with underlying materials. Bentonite (particularly powdered bentonite) may be blown away by wind when it is placed on the surface of a loose lift, thus reducing the amount of bentonite that is actually incorporated into the soil. The mixing equipment may fail to pass over all areas of the loose lift and may inadequately mix certain portions of the loose lift. Because of these problems many engineers believe that pugmill mixing provides a more reliable means for mixing bentonite with soil. CQA personnel should carefully examine the mixing process to ensure that the problems outlined above, or other problems, do not compromise the quality of the mixing process. Visual examination of the mixture to verify plasticity (see Section 2.5 and Table 2.5) is recommended.

2.6.5.3 Measuring Bentonite Content

The best way to control the amount of bentonite mixed with soil is to measure the relative weights of soil and bentonite blended together at the time of mixing. After bentonite has been

mixed with soil there are several techniques available to estimate the amount of bentonite in the soil. None of the techniques are particularly easy to use in all situations.

The recommended technique for measuring the amount of bentonite in soil is the methylene blue test (Alther, 1983). The methylene blue test is a type of titration test. Methylene blue is slowly titrated into a material and the amount of methylene blue required to saturate the material is determined. The more bentonite in the soil the greater the amount of methylene blue that must be added to achieve saturation. A calibration curve is developed between the amount of methylene blue needed to saturate the material and the bentonite content of the soil. The methylene blue test works very well when bentonite is added into a non-clayey soil. However, the amount of methylene blue that must be added to the soil is a function of the amount of clay present in the soil. If clay minerals other than bentonite are present, the clay minerals interfere with the determination of the bentonite content. There is no standard methylene blue test; the procedure outlined in Alther (1983) is suggested until such time as a standard test method is developed.

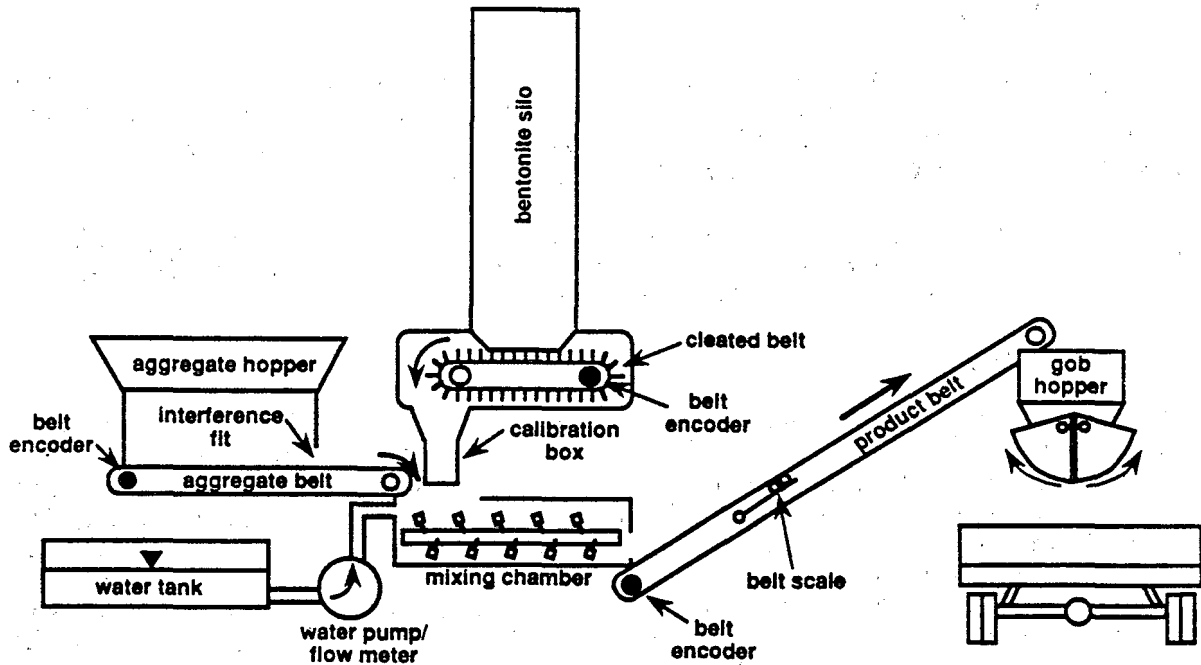

Figure 2.30 - Schematic Diagram of Pugmill

Another type of test that has been used to estimate bentonite content is the filter press test. This test is essentially a water absorbency test: the greater the amount of clay in a soil, the greater the water holding capacity. Like the methylene blue test, the filter press test works well if bentonite is the only source of clay in the soil. No specific test procedure was available at the time of this writing.

Measurement of hydraulic conductivity provides a means for verifying that enough bentonite has been added to the soil to achieve the desired low hydraulic conductivity. If insufficient bentonite has been added, the hydraulic conductivity should be unacceptably large. However, just because the hydraulic conductivity is acceptably low for a given sample does not necessarily mean that the required amount of bentonite has been added to the soil at all locations. Indeed, extra bentonite beyond the minimum amount required is added to soil so that there will be sufficient bentonite present even at those locations that are "lean" in bentonite.

The recommended tests and testing frequencies to verify proper addition of bentonite are summarized in Table 2.7. However, the CQA personnel must realize that the amount of testing depends on the degree of control in the mixing process: the more control during mixing, the less is the need for testing to verify the proper bentonite content.

Table 2.7 - Recommended Tests to Verify Bentonite Content

| Parameter | Frequency | Test Method |
|---|----------------------------|---|
| Methylene Blue Test | 1 per 1,000 m ³ | Alther (1983) |
| Compaction Curve for Soil-Bentonite Mixture (Needed To Prepare Hydraulic Conductivity Test Specimen) | 1 per 5,000 m ³ | Per Project Specifications, e.g., ASTM D-698 or D-1557 |
| Hydraulic Conductivity of Soil-Bentonite Mixture Compacted to Appropriate Water Content and Dry Unit Weight | 3/ha/Lift (1/Acre/Lift) | ASTM D-5084, "Hydraulic Conductivity of Saturated Porous Materials Using a Flexible Wall Permeameter" |

Note: 1 yd³ = 0.76 m³

2.6.6 Stockpiling Soils

After the soil has been preprocessed it is usually necessary to ensure that the water content does not change prior to use. The stockpiles can be of any size or shape. Small stockpiles should be covered so that the soil cannot dry or wet. For large stockpiles, it may not be necessary to cover the stockpile, particularly if the stockpile is sloped to promote drainage, moisture is added occasionally to offset drying at the surface, or other steps are taken to minimize wetting or drying of the stockpiled soil.

2.7 Placement of Loose Lift of Soil

After a soil has been fully processed, the soil is hauled to the final placement area. Soil should not be placed in adverse weather conditions, e.g., heavy rain. Inspectors are usually responsible for documenting weather conditions during all earthwork operations. The surface on

which the soil will be placed must be properly prepared and the material must be inspected after placement to make sure that the material is suitable. Then the CQA inspectors must also verify that the lift is not too thick. For side slopes, construction specifications should clearly state whether lifts are parallel to the slope or horizontal. For slopes inclined at 3(H):1(V) or flatter, lifts are usually parallel to the slope. For slopes inclined at 2(H):1(V) or steeper, lifts are usually horizontal. However, horizontal lifts may present problems because the hydraulic conductivity for flow parallel to lifts is expected to be somewhat greater than for flow perpendicular to lifts. Details of testing are described in the following subsections.

Transport vehicles can pick up contaminants while hauling material from the borrow source or preprocessing area. If this occurs, measures should be taken to prevent contaminants from falling off transport vehicles into the soil liner material. These measures may include restricting vehicles to contaminant free haul roads or removing contaminants before the vehicle enters the placement area.

2.7.1 Surface Scarification

Prior to placement of a new lift of soil, the surface of the previously compacted lift of soil liner should be roughened to promote good contact between the new and old lifts. Inspectors should observe the condition of the surface of the previously compacted lift to make sure that the surface has been scarified as required in the construction specifications. When soil is scarified it is usually roughened to a depth of about 25 mm (1 in.). In some cases the surface may not require scarification if the surface is already rough after the end of compaction of a lift. It is very important that CQA inspectors ensure that the soil has been properly scarified if construction specifications require scarification. If the soil is scarified, the scarified zone becomes part of the loose lift of soil and should be counted in measuring the loose lift thickness.

2.7.2 Material Tests and Visual Inspection

2.7.2.1 Material Tests

After a loose lift of soil has been placed, samples are periodically taken to confirm the properties of the soil liner material. These samples are in addition to samples taken from the borrow area (Table 2.3). The types of tests and frequency of testing are normally specified in the CQA documents. Table 2.8 summarizes recommended minimum tests and testing frequencies. Samples of soils can be taken either on a grid pattern or on a random sampling pattern (see Section 2.8.3.2). Statistical tests and criteria can be applied but are not usually applied to soil liners in part because enough data have to be gathered to apply statistics, and yet decisions have to be made immediately, before very much data are collected.

2.7.2.2 Visual Observations

Inspectors should position themselves near the working face of soil liner material as it is being placed. Inspectors should look for deleterious materials such as stones, debris, and organic matter. Continuous inspection of the placement of soil liner material is recommended to ensure that the soil liner material is of the proper consistency.

2.7.2.3 Allowable Variations

Tests on soil liner materials may occasionally fail to conform with required specifications. It is unrealistic to think that 100% of a soil liner material will be in complete conformance with specifications. For example, if the construction documents require a minimum plasticity index it

may be anticipated that a small fraction of the soil (such as pockets of sandy material) will fail to conform with specifications. It is neither unusual nor unexpected that occasional failing material will be encountered in soil liners. Occasional imperfections in soil liner materials are expected. Indeed, one of the reasons why multiple lifts are used in soil liners is to account for the inevitable variations in the materials of construction employed in building soil liners. Occasional deviations from construction specifications are not harmful. Recommended maximum allowable variations (failing tests) are listed in Table 2.9.

Table 2.8 - Recommended Materials Tests for Soil Liner Materials Sampled after Placement in a Loose Lift (Just Before Compaction)

| Parameter | Test Method | Minimum Testing Frequency |
|-------------------------------|---------------|--|
| Percent Fines (Note 1) | ASTM D-1140 | 1 per 800 m ³ (Notes 2 & 5) |
| Percent Gravel (Note 3) | ASTM D-422 | 1 per 800 m ³ (Notes 2 & 5) |
| Liquid & Plastic Limits | ASTM D-4318 | 1 per 800 m ³ (Notes 2 & 5) |
| Percent Bentonite (Note 4) | Alther (1983) | 1 per 800 m ³ (Notes 2 & 5) |
| Compaction Curve | As Specified | 1 per 4,000 m ³ (Note 5) |
| Construction Oversight | Observation | Continuous |

Notes:

1. Percent fines is defined as percent passing the No. 200 sieve.
2. In addition, at least one test should be performed each day that soil is placed, and additional tests should be performed on any suspect material observed by CQA personnel.
3. Percent gravel is defined as percent retained on the No. 4 sieve.
4. This test is only applicable to soil-bentonite liners.
5. 1 yd³ = 0.76 m³.

Table 2.9 - Recommended Maximum Percentage of Failing Material Tests

| Parameter | Maximum Allowable Percentage of Outliers |
|---|---|
| Atterberg Limits | 5% and Outliers Not Concentrated in One Lift or One Area |
| Percent Fines | 5% and Outliers Not Concentrated in One Lift or One Area |
| Percent Gravel | 10% and Outliers Not Concentrated in One Lift or One Area |
| Clod Size | 10% and Outliers Not Concentrated in One Lift or One Area |
| Percent Bentonite | 5% and Outliers Not Concentrated in One Lift or One Area |
| Hydraulic Conductivity of Laboratory Compacted Soil | 5% and Outliers Not Concentrated in One Lift or One Area |

2.7.2.4 Corrective Action

If it is determined that the materials in an area do not conform with specifications, the first step is to define the extent of the area requiring repair. A sound procedure is to require the contractor to repair the lift of soil out to the limits defined by passing CQC/CQA tests. The contractor should not be allowed to guess at the extent of the area that requires repair. To define the limits of the area that requires repair, additional tests are often needed. Alternatively, if the contractor chooses not to request additional tests, the contractor should repair the area that extends from the failing test out to the boundaries defined by passing tests.

The usual corrective action is to wet or dry the loose lift of soil in place if the water content is incorrect. The water must be added uniformly, which requires mixing the soil with a disc or rototiller (see Section 2.6.1). If the soil contains oversized material, oversized particles are removed from the material (see Section 2.6.2). If clods are too large, clods can be pulverized in the loose lift (see Section 2.6.3). If the soil lacks adequate plasticity, contains too few fines, contains too much gravel, or lacks adequate bentonite, the material is normally excavated and replaced.

2.7.3 Placement and Control of Loose Lift Thickness

Construction specifications normally place limits on the maximum thickness of a loose lift of soil, e.g., 225 mm (9 in.). The thickness of a loose lift should not exceed this value with normal equipment. The thickness of a loose lift may be determined in several ways. One technique is for an inspector standing near the working face of soil being placed to observe the thickness of the lift. This is probably the most reliable technique for controlling loose lift thickness for CQA inspectors. If there is a question about loose lift thickness one should dig a pit through the loose lift of soil and into the underlying layer. A cross-beam is used to measure the depth from the surface of a loose lift to the top of the previously compacted lift. If the previously compacted lift was scarified, the zone of scarification should be counted in the loose lift thickness for the new layer of soil. Continuous observation of loose lift thickness is recommended during placement of

soil liners.

Some earthwork contractors control lift thickness by driving grade stakes into the subsoil and marking the grade stake to indicate the proper thickness of the next layer. This practice is very convenient for equipment operators because they can tell at a glance whether the loose lift thickness is correct. However, this practice is strongly discouraged for the second and subsequent lifts of a soil liner because the penetrations into the previously-compacted lift made by the grade stakes must be repaired. Also, any grade stakes or fragments from grade stakes left in a soil liner could puncture overlying geosynthetics. Repair of holes left by grade stakes is very difficult because one must dig through the loose lift of soil to expose the grade stake, remove the grade stake without breaking the stake and leaving some of the stake in the soil, backfill the hole left by the grade stake, and then replace the loose soil in the freshly-placed lift. For the first lift of soil liner, repair of grade stake holes may not be relevant (depending on the subgrade and what its function is), but grade stakes are discouraged even for the first lift of soil because the stakes may be often broken off and incorporated into the soil. Grade stakes resting on a small platform or base do not need to be driven into the underlying material and are, therefore, much more desirable than ordinary grade stakes. If grade stakes are used, it is recommended that they be numbered and accounted for at the end of each shift; this will provide verification that grade stakes are not being abandoned in the fill material.

The recommended survey procedure for control of lift thickness involves laser sources and receivers. A laser beam source is set at a known elevation, and reception devices held by hand on rods or mounted to grading equipment are used to monitor lift thickness. However, lasers cannot be used at all sites. For instance, the liner may need to be a minimum distance above rock, and the grade lines may follow the contours of underlying rock. Further, every site has areas such as corners, sumps, and boundaries of cells, which preclude the use of lasers.

For those areas where lasers cannot be used, it is recommended that either flexible plastic grade stakes or metallic grade stakes (numbered and inventoried as part of the QA/QC process) be used. It is preferable if the stakes are mounded on a base so that the stakes do not have to be driven into the underlying lift. Repair of grade stake holes should be required; the repairs should be periodically inspected and the repairs documented. Alternatively (and preferably for small areas), spot elevations can be obtained on the surface of a loose lift with conventional level and rod equipment, and adjustments made by the equipment operator based on the levels.

When soil is placed, it is usually dumped into a heap at the working face and spread with dozers. QA/QC personnel should stand in front of the working face to observe the soil for oversized materials or other deleterious material, to visually observe loose lift thickness, and to make sure that the dozer does not damage an underlying layer.

2.8 Remolding and Compaction of Soil

2.8.1 Compaction Equipment

The important parameters concerning compaction equipment are the type and weight of the compactor, the characteristics of any feet on the drum, and the weight of the roller per unit length of drummed surface. Sometimes construction specifications will stipulate a required type of compactor or minimum weight of compactor. If this is the case inspectors should confirm that the compaction equipment is in conformance with specifications. Inspectors should be particularly cognizant of the weight of compactor and length of feet on drummed rollers. Heavy compactors with long feet that fully penetrate a loose lift of soil are generally thought to be the best type of compactor to use for soil liners. Footed rollers may not be necessary or appropriate for some

bentonite-soil mixes; smooth-drum rollers or rubber tired rollers may produce best results for soil-bentonite mixtures that do not require kneading or remolding to achieve low hydraulic conductivity but only require densification.

Some compactors are self-propelled while other compactors are towed. Towed, footed rollers are normally ballasted by filling the drum with water to provide weight that will enable significant compactive effort to be delivered to the soil. Inspectors should be very careful to determine whether or not all drums on towed rollers have been filled with liquid.

Compacting soil liners on side slopes can present special challenges, particularly for slopes inclined at 3(H):1(V) or steeper. Inspectors should observe side-slope compaction carefully and watch for any tendency for the compactor to slip down slope or for slippage or cracking to take place in the soil. Inspectors should also be watchful to make sure that adequate compactive effort is delivered to the soil. For soils compacted in lifts parallel to the slope, the first lift of soil should be "knitted" into existing subgrade to minimize a preferential flow path along the interface and to minimize development of a potential slip plane.

Footed rollers can become clogged with soil between the feet. Inspectors should examine the condition of the roller to make sure that the space between feet is not plugged with soil. In addition, compaction equipment is intended to be operated at a reasonable speed. The maximum speed of the compactor should be specified in the construction specifications. CQC and CQA personnel should make sure the speed of the equipment is not too great.

When soils are placed directly on a fragile layer, such as a geosynthetic material, or a drainage material, great care must be taken in placing and compacting the first lift so as not to damage the fragile material or mix clay in with the underlying drainage material. Often, the first lift of soil is considered a sacrificial lift that is placed, spread with dozers, and only nominally compacted with the dozers or a smooth-drum or rubber-tire roller. QA/QC personnel should be particularly careful to observe all placement and compaction operations of the first lift of soil for compacted soil liners placed directly on a geosynthetic material or drainage layer.

It is not uncommon for a contractor to use more than one type of compaction equipment on a project. For example, initial compaction may be with a heavy roller having long feet that fully penetrate a loose lift of soil. Later, the upper part of a lift may be compacted with a heavy rubber-tired roller or other equipment that is particularly effective in compacting near-surface materials.

2.8.2 Number of Passes

The compactive effort delivered by a roller is a function of the number of passes of the roller over a given area of soil. A pass may be defined as one pass of the construction equipment or one pass of a drum over a given point in the soil liner. It does not matter whether a pass is defined as a pass of the equipment or a pass of a drum, but the construction specifications and/or CQA plan should define what is meant by a pass. Normally, one pass of the vehicle constitutes a pass for self-propelled rollers and one pass of a drum constitutes a pass for towed rollers.

Some construction documents require a minimum coverage. Coverage (C) is defined as follows:

$$C = [A_f/A_d] \times N \times 100\% \quad (2.4)$$

where N is the number of passes of the roller, A_f is the sum of the area of the feet on the drums of the roller, and A_d is the area the drum itself. Construction specifications sometimes require 150% -

200% coverage of the roller. For a given roller and minimum percent coverage, the minimum number of passes (N) may be computed.

The number of passes of a compactor over the soil can have an important influence on the overall hydraulic conductivity of the soil liner. It is recommended that periodic observations be made of the number of passes of the roller over a given point. Approximately 3 observations per hectare per lift (one observation per acre per lift) is the recommended frequency of measurement. The minimum number of passes that is reasonable depends upon many factors and cannot be stated in general terms. However, experience has been that at least 5 to 15 passes of a compactor over a given point is usually necessary to remold and compact clay liner materials thoroughly.

2.8.3 Water Content and Dry Unit Weight

2.8.3.1 Water Content and Unit Weight Tests

One of the most important CQA tests is measurement of water content and dry unit weight. Methods of measurement were discussed in Section 2.3. Recommended testing frequencies are listed in Table 2.10. It is stressed that the recommended testing frequencies are the minimum values. Some judgment should be applied to these numbers, and the testing frequencies should be increased or kept at the minimum depending on the specific project and other QA/QC tests and observations. For example, if hydraulic conductivity tests are not performed on undisturbed samples (see Section 2.8.4.2), more water content/density tests may be required than the usual minimum.

2.8.3.2 Sampling Patterns

There are several ways in which sample locations may be selected for water content and unit weight tests. The simplest and least desirable method is for someone in the field to select locations at the time samples must be taken. This is undesirable because the selector may introduce a bias into the sampling pattern. For example, perhaps on the previous project soils of one particular color were troublesome. If the individual were to focus most of the tests on the current project on soils of that same color a bias might be introduced.

A common method of selecting sample locations is to establish a grid pattern. The grid pattern is simple and ensures a high probability of locating defective areas so long as the defective areas are of a size greater than or equal to the spacing between the sampling points. It is important to stagger the grid patterns in successive lifts so that sampling points are not at the same location in each lift. One would not want to sample at the same location in successive lifts because repaired sample penetrations would be stacked on top of one another. The grid pattern sampling procedure is the simplest one to use that avoids the potential for bias described in the previous paragraph.

A third alternative for selecting sampling points is to locate sampling points randomly. Tables and examples are given in Richardson (1992). It is recommended that no sampling point be located within 2 meters of another sampling point. If a major portion of the area to be sampled has been omitted as a result of the random sampling process, CQA inspectors may add additional points to make sure the area receives some testing. Random sampling is sometimes preferred on large projects where statistical procedures will be used to evaluate data. However, it can be demonstrated that for a given number of sampling points, a grid pattern will be more likely to detect a problem area provided that the dimensions of the problem area are greater than or equal to the spacing between sampling points. If the problem area is smaller than the spacing between sampling points, the probability of locating the problem area is approximately the same with both a grid pattern and a random pattern of sampling.

Table 2.10 - Recommended Tests and Observations on Compacted Soil

| Parameter | Test Method | Minimum Testing Frequency |
|-----------------------------------|--|---|
| Water Content (Rapid) (Note 1) | ASTM D-3017 ASTM D-4643 ASTM D-4944 ASTM D-4959 | 13/ha/lift (5/acre/lift) (Notes 2 & 7) |
| Water Content (Note 3) | ASTM D-2216 | One in every 10 rapid water content tests (Notes 3 & 7) |
| Total Density (Rapid) (Note 4) | ASTM D-2922 ASTM D-2937 | 13/ha/lift (5/acre/lift) (Notes 2, 4 & 7) |
| Total Density (Note 5) | ASTM D-1556 ASTM D-1587 ASTM D-2167 | One in every 20 rapid density tests (Notes 5, 6, & 7) |
| Number of Passes | Observation | 3/ha/lift (1/acre/lift) (Notes 2 & 7) |
| Construction Oversight | Observation | Continuous |

Notes:

1. ASTM D-3017 is a nuclear method, ASTM D-4643 is microwave oven drying, ASTM D-4944 is a calcium carbide gas pressure tester method, and ASTM D-4959 is a direct heating method. Direct water content determination (ASTM D-2216) is the standard against which nuclear, microwave, or other methods of measurements are calibrated for on-site soils.
2. In addition, at least one test should be performed each day soil is compacted and additional tests should be performed in areas for which CQA personnel have reason to suspect inadequate compaction.
3. Every tenth sample tested with ASTM D-3017, D-4643, D-4944, or D-4959 should be also tested by direct oven drying (ASTM D-2216) to aid in identifying any significant, systematic calibration errors.
4. ASTM D-2922 is a nuclear method and ASTM D-2937 is the drive cylinder method. These methods, if used, should be calibrated against the sand cone (ASTM D-1556) or rubber balloon (ASTM D-2167) for on-site soils. Alternatively, the sand cone or rubber balloon method can be used directly.
5. Every twentieth sample tested with D-2922 should also be tested (as close as possible to the same test location) with the sand cone (ASTM D-1556) or rubber balloon (ASTM D-2167) to aid in identifying any systematic calibration errors with D-2922.
6. ASTM D-1587 is the method for obtaining an undisturbed sample. The section of undisturbed sample can be cut or trimmed from the sampling tube to determine bulk density. This method should not be used for soils containing any particles > 1/6-th the diameter of the sample.
7. 1 acre = 0.4 ha.

No matter which method of determining sampling points is selected, it is imperative that CQA inspectors have the responsibility to perform additional tests on any suspect area. The number of additional testing locations that are appropriate varies considerably from project to project.

2.8.3.3 Tests with Different Devices to Minimize Systematic Errors

Some methods of measurement may introduce a systematic error. For example, the nuclear device for measuring water content may consistently produce a water content measurement that is too high if there is an extraneous source of hydrogen atoms besides water in the soil. It is important that devices that may introduce a significant systematic error be periodically correlated with measurements that do not have such error. Water content measurement tests have the greatest potential for systematic error. Both the nuclear method as well as microwave oven drying can produce significant systematic error under certain conditions. Therefore, it is recommended that if the nuclear method or any of the rapid methods of water content measurement (Table 2.2) are used to measure water content, periodic correlation tests should be made with conventional overnight oven drying (ASTM D-2216).

It is suggested that at the beginning of a project, at least 10 measurements of water content be determined on representative samples of the site-specific soil using any rapid measurement method to be employed on the project as well as ASTM D-2216. After this initial correlation, it is suggested (see Tables 2.10) that one in ten rapid water content tests be crossed check with conventional overnight oven drying. At the completion of a project a graph should be presented that correlates the measured water content with a rapid technique against the water content from conventional overnight oven drying.

Some methods of unit weight measurement may also introduce bias. For example, the nuclear device may not be properly calibrated and could lead to measurement of a unit weight that is either too high or too low. It is recommended that unit weight be measured independently on occasion to provide a check against systematic errors. For example, if the nuclear device is the primary method of density measurement being employed on a project, periodic measurements of density with the sand cone or rubber balloon device can be used to check the nuclear device. Again, a good practice is to perform about 10 comparative tests on representative soil prior to construction. During construction, one in every 20 density tests (see Table 2.10) should be checked with the sand cone or rubber balloon. A graph should be made of the unit weight measured with the nuclear device versus the unit weight measured with the sand cone or rubber balloon device to show the correlation. One could either plot dry unit weight or total unit weight for the correlation. Total unit weight in some ways is more sensible because the methods of measurement are actually total unit weight measurements; dry unit weight is calculated from the total unit weight and water content (Eq. 2.1.).

2.8.3.4 Allowable Variations and Outliers

There are several reasons why a field water content or density test may produce a failing result, i.e., value outside of the specified range. Possible causes for a variation include a human error in measurement of water content or dry unit weight, natural variability of the soil or the compaction process leading to an anomaly at an isolated location, limitations in the sensitivity and repeatability of the test methods, or inadequate construction procedures that reflect broader-scale deficiencies.

Measurement errors are made on every project. From time to time it can be expected that CQC and CQA personnel will incorrectly measure either the water content or the dry unit weight.

Periodic human errors are to be expected and should be addressed in the CQA plan.

If it is suspected that a test result is in error, the proper procedure for rectifying the error should be as follows. CQC or CQA personnel should return to the point where the questionable measurement was obtained. Several additional tests should be performed in close proximity to the location of the questionable test. If all of the repeat tests provide satisfactory results the questionable test result may be disregarded as an error. Construction quality assurance documents should specify the number of tests required to negate a blunder. It is recommended that approximately 3 passing tests be required to negate the results of a questionable test.

One of the main reasons why soil liners are built of multiple lifts is a realization that the construction process and the materials themselves vary. With multiple lifts no one particular point in any one lift is especially significant even if that point consists of unsatisfactory material or improperly compacted material. It should be expected that occasional deviations from construction specifications will be encountered for any soil liner. In fact, if one were to take enough soil samples, one can rest assured that a failing point on some scale would be located.

Measurement techniques for compacted soils are imperfect and produce variable results. Turnbull et al. (1966) discuss statistical quality control for compacted soils. Noorany (1990) describes 3 sites in the San Diego area for which 9 testing laboratories measured water content and percent compaction on the same fill materials. The ranges in percent compaction were very large: 81-97% for Site 1, 77-99% for Site 2, and 89-103% for Site 3.

Hilf (1991) summarizes statistical data from 72 earth dams; the data show that the standard deviation in water content is typically 1 to 2%, and the standard deviation in dry density is typically 0.3 to 0.6 kN/m³ (2 to 4 pcf). Because the standard deviations are themselves on the same order as the allowable range of these parameters in many earthwork specifications, it is statistically inevitable that there will be some failing tests no matter how well built the soil liner is.

It is unrealistic to expect that 100% of all CQA tests will be in compliance with specifications. Occasional deviations should be anticipated. If there are only a few randomly-located failures, the deviations in no way compromise the quality or integrity of a multiple-lift liner.

The CQA documents may provide an allowance for an occasional failing test. The documents may stipulate that failing tests not be permitted to be concentrated in any one lift or in any one area. It is recommended that a small percentage of failing tests be allowed rather than insisting upon the unrealistic requirement that 100% of all tests meet project objectives. Statistically based requirements provide a convenient yet safe and reliable technique for handling occasional failing test results. However, statistically based methods require that enough data be generated to apply statistics reliably. Sufficient data to apply statistical methods may not be available, particularly in the early stages of a project.

Another approach is to allow a small percentage of outliers but to require repair of any area where the water content is far too low or high or the dry unit weight is far too low. This approach is probably the simplest to implement -- recommendations are summarized in Table 2.11.

Table 2.11 - Recommended Maximum Percentage of Failing Compaction Tests

| Parameter | Maximum Allowable Percentage of Outliers |
|------------------|---|
| Water Content | 3% and Outliers Not Concentrated in One Lift or One Area, and No Water Content Less than 2% or More than 3% of the Allowable Value |
| Dry Density | 3% and Outliers Not Concentrated in One Lift or One Area, and No Dry Density Less than 0.8 kN/m ³ (5 pcf) Below the Required Value |
| Number of Passes | 5% and Outliers Not Concentrated in One Lift or One Area |

2.8.3.5 Corrective Action

If it is determined that an area does not conform with specifications and that the area needs to be repaired, the first step is to define the extent of the area requiring repair. The recommended procedure is to require the contractor to repair the lift of soil out to the limits defined by passing CQC and CQA tests. The contractor should not be allowed to guess at the extent of the area that requires repair. To define the limits of the area that requires repair, additional tests are often needed. Alternatively, if the contractor chooses not to request additional tests, the contractor should repair the area that extends from the failing test out to the boundaries defined by passing tests.

The usual problem requiring corrective action at this stage is inadequate compaction of the soil. The contractor is usually able to rectify the problem with additional passes of the compactor over the problem area.

2.8.4 Hydraulic Conductivity Tests on Undisturbed Samples

Hydraulic conductivity tests are often performed on "undisturbed" samples of soil obtained from a single lift of compacted soil liner. Test specimens are trimmed from the samples and are permeated in the laboratory. Compliance with the stated hydraulic conductivity criterion is checked.

This type of test is given far too much weight in most QA programs. Low hydraulic conductivity of samples taken from the liner is necessary for a well-constructed liner but is not sufficient to demonstrate that the large-scale, field hydraulic conductivity is adequately low. For example, Elsbury et al. (1990) measured hydraulic conductivities on undisturbed samples of a poorly constructed liner that averaged 1×10^{-9} cm/s, and yet the actual in-field value was 1×10^{-5} cm/s. The cause for the discrepancy was the existence of macro-scale flow paths in the field that were not simulated in the small-sized (75 mm or 3 in. diameter) laboratory test specimens.

Not only does the flow pattern through a 75-mm-diameter test specimen not necessarily reflect flow patterns on a larger field scale, but the process of obtaining a sample for testing inevitably disturbs the soil. Layers are distorted, and gross alterations occur if significant gravel is

present in the soil. The process of pushing a sampling tube into the soil densifies the soil, which lowers its hydraulic conductivity. The harder and drier the soil, the greater the disturbance. As a result of these various factors, the large-scale, field hydraulic conductivity is almost always greater than or equal to the small-scale, laboratory-measured hydraulic conductivity. The difference between values from a small laboratory scale and a large field scale depends on the quality of construction -- the better the quality of construction, the less the difference.

Laboratory hydraulic conductivity tests on undisturbed samples of compacted liner can be valuable in some situations. For instance, for soil-bentonite mixes, the laboratory test provides a check on whether enough bentonite has been added to the mix to achieve the desired hydraulic conductivity. For soil liners in which a test pad is not constructed, the laboratory tests provide some verification that appropriate materials have been used and compaction was reasonable (but hydraulic conductivity tests by themselves do not prove this fact).

Laboratory hydraulic conductivity tests constitute a major inconvenience because the tests usually take at least several days, and sometimes a week or two, to complete. Their value as QA tools is greatly diminished by the long testing time -- field construction personnel simply cannot wait for the results of the tests to proceed with construction, nor would the QA personnel necessarily want them to wait because opportunities exist for damage of the liner as a result of desiccation. Thus, one should give very careful consideration as to whether the laboratory hydraulic conductivity tests are truly needed for a given project and will serve a sufficiently useful purpose to make up for the inconvenience of this type of test.

Research is currently underway to determine if larger-sized samples from field-compacted soils can give more reliable results than the usual 75-mm (3 in.) diameter samples. Until further data are developed, the following recommendations are made concerning the approach to utilizing laboratory hydraulic conductivity tests for QA on field-compacted soils:

1. For gravely soils or other soils that cannot be consistently sampled without causing significant disturbance, laboratory hydraulic conductivity tests should not be a part of the QA program because representative samples cannot realistically be obtained. A test pad (Section 2.10) is recommended to verify hydraulic conductivity.
2. If a test pad is constructed and it is demonstrated that the field-scale hydraulic conductivity is satisfactory on the test pad, the QA program for the actual soil liner should focus on establishing that the actual liner is built of similar materials and to equal or better standards compared to the test pad -- laboratory hydraulic conductivity testing is not necessary to establish this.
3. If no test pad is constructed and it is believed that representative samples can be obtained for hydraulic conductivity testing, then laboratory hydraulic conductivity tests on undisturbed samples from the field are recommended.

2.8.4.1 Sampling for Hydraulic Conductivity Testing

A thin-walled tube is pushed into the soil to obtain a sample. Samples of soil should be taken in the manner that minimizes disturbance such as described in ASTM D-1587. Samples should be sealed and carefully stored to prevent drying and transported to the laboratory in a manner that minimizes soil disturbance as described in ASTM D-4220.

It is particularly important that the thin-walled sampling tube be pushed into the soil in the direction perpendicular to the plane of compaction. Many CQA inspectors will push the sampling

tube into the soil using the blade of a dozer or compactor. This practice is not recommended because the sampling tube tends to rotate when it is pushed into the soil. The recommended way of sampling the soil is to push the sampling tube straight into the soil using a jack to effect a smooth, straight push.

Sampling of gravely soils for hydraulic conductivity testing is often a futile exercise. The gravel particles that are encountered by the sampling tube tend to tumble and shear during the push, which caused major disturbance of the soil sample. Experience has been that QA/QC personnel may take several samples of gravely soil before a sample that is sufficiently free of gravel to enable proper sampling is finally obtained; in these cases, the badly disturbed, gravely samples are discarded. Clearly, the process of discarding samples because they contain too much gravel to enable proper sampling introduces a bias into the process. Gravely soils are not amenable to undisturbed sampling.

2.8.4.2 Hydraulic Conductivity Testing

Hydraulic conductivity tests are performed utilizing a flexible wall permeameter and the procedures described in ASTM D-5084. Inspectors should be careful to make sure that the effective confining stress utilized in the hydraulic conductivity test is not excessive. Application of excessive confining stress can produce an artificially low hydraulic conductivity. The CQA plan should prescribe the maximum effective confining stress that will be used; if none is specified a value of 35 kPa (5 psi) is recommended for both liner and cover systems.

2.8.4.3 Frequency of Testing

Hydraulic conductivity tests are typically performed at a frequency of 3 tests/ha/lift (1 test/acre/lift) or, for very thick liners (≥ 1.2 m or 4 ft) per every other lift. This is the recommended frequency of testing, if hydraulic conductivity testing is required. The CQA plan should stipulate the frequency of testing.

2.8.4.4 Outliers

The results of the above-described hydraulic conductivity tests are often given far too much weight. A passing rate of 100% does not necessarily prove that the liner was well built, yet some inexperienced individuals falsely believe this to be the case. Hydraulic conductivity tests are performed on small samples; even though small samples may have low hydraulic conductivity, inadequate construction or CQA can leave remnant macro-scale defects such as fissures and pockets of poorly compacted soil. The fundamental problem is that laboratory hydraulic conductivity tests are usually performed on 75-mm (3 in.) diameter samples, and these samples are too small to contain a representative distribution of macro-scale defects (if any such defects are present). By the same token, an occasional failing test does not necessarily prove that a problem exists. An occasional failing test only shows that either: (1) there are occasional zones that fail to meet performance criteria, or (2) sampling disturbance (e.g., from the sampling tube shearing stones in the soil) makes confirmation of low hydraulic conductivity difficult or impossible. Soil liners built of multiple lifts are expected to have occasional, isolated imperfections -- this is why the liners are constructed from multiple lifts. Thus, occasional failing hydraulic conductivity tests by themselves do not mean very much. Even on the best built liners, occasional failing test results should be anticipated.

It is recommended that a multiple-lift soil liner be considered acceptable even if a small percentage (approximately 5%) of the hydraulic conductivity tests fail. However, one should allow a small percentage of hydraulic conductivity failures only if the overall CQA program is

thorough. Further, it is recommended that failing samples have a hydraulic conductivity that is no greater than one-half to one order of magnitude above the target maximum value. If the hydraulic conductivity at a particular point is more than one-half to one order of magnitude too high, the zone should be retested or repaired regardless of how isolated it is.

2.8.5 Repair of Holes from Sampling and Testing

A number of tests, e.g., from nuclear density tests and sampling for hydraulic conductivity, require that a penetration be made into a lift of compacted soil. It is extremely important that all penetrations be repaired. The recommended procedure for repair is as follows. The backfill material should first be selected. Backfill may consist of the soil liner material itself, granular or pelletized bentonite, or a mixture of bentonite and soil liner material. The backfill material should be placed in the hole requiring repair with a loose lift thickness not exceeding about 50 mm (2 in.). The loose lift of soil should be tamped several times with a steel rod or other suitable device that compacts the backfill and ensures no bridging of material that would leave large air pockets. Next, a new lift of backfill should be placed and compacted. The process is repeated until the hole has been filled.

Because it is critical that holes be properly repaired, it is recommended that periodic inspections and written records made of the repair of holes. It is suggested that approximately 20% of all the repairs be inspected and that the backfill procedures be documented for these inspections. It is recommended that the inspector of repair of holes not be the same person who backfilled the hole.

2.8.6 Final Lift Thickness

Construction documents may place restrictions on the maximum allowable final (after-compaction) lift thickness. Typically, the maximum thickness is 150 mm (6 in.). Final elevation surveys should be used to establish thicknesses of completed earthwork segments. The specified maximum lift thickness is a nominal value. The actual value may be determined by surveys on the surface of each completed lift, but an acceptable practice (provided there is good CQA on loose lift thickness) is to survey the liner after construction and calculate the average thickness of each lift by dividing the total thickness by the number of lifts.

Tolerances should be specified on final lift thickness. Occasional outliers from these tolerances are not detrimental to the performance of a multi-lift liner. It is recommended by analogy to Table 2.9 that no more than 5% of the final lift thickness determinations be out of specification and that no out-of-specification thickness be more than 25 mm (1 in.) more than the maximum allowable lift thickness.

2.8.7 Pass/Fail Decision

After all CQA tests have been performed, a pass/fail decision must be made. Procedures for dealing with materials problems were discussed in Section 2.7.2.4. Procedures for correcting deficiencies in compaction of the soil were addressed in Section 2.8.3.5. A final pass/fail decision is made by the CQA engineer based upon all the data and test results. The hydraulic conductivity test results may not be available for several days after construction of a lift has been completed. Sometimes the contractor proceeds at risk with placement of additional lifts before all test results are available. On occasion, construction of a liner proceeds without final results from a test pad on the assumption that results will be acceptable. If a "fail" decision is made at this late stage, the defective soil plus any overlying materials that have been placed should be removed and replaced.

2.9 Protection of Compacted Soil

2.9.1 Desiccation

2.9.1.1 Preventive Measures

There are several ways to prevent compacted soil liner materials from desiccating. The soil may be smooth rolled with a steel drummed roller to produce a thin, dense skin of soil on the surface. This thin skin of very dense soil helps to minimize transfer of water into or out of the underlying material. However, the smooth-rolled surface should be scarified prior to placement of a new lift of soil.

A far better preventive measure is to water the soil periodically. Care must be taken to deliver water uniformly to the soil and not to create zones of excessively wet soil. Adding water by hand is not recommended because water is not delivered uniformly to the soil.

An alternative preventive measure is to cover the soil temporarily with a geomembrane, moist geotextile, or moist soil. The geomembrane or geotextile should be weighted down with sand bags or other materials to prevent transfer of air between the geosynthetic cover and soil. If a geomembrane is used, care should be taken to ensure that the underlying soil does not become heated and desiccate; a light-colored geomembrane may be needed to prevent overheating. If moist soil is placed over the soil liner, the moist soil is removed using grading equipment.

2.9.1.2 Observations

Visual observation is the best way to ensure that appropriate preventive measures have been taken to minimize desiccation. Inspectors should realize that soil liner materials can dry out very quickly (sometimes in a matter of just a few hours). Inspectors should be aware that drying may occur over weekends and provisions should be made to provide appropriate observations.

2.9.1.3 Tests

If there are questions about degree of desiccation, tests should be performed to determine the water content of the soil. A decrease in water content of one to two percentage points is not considered particularly serious and is within the general accuracy of testing. However, larger reductions in water content provide clear evidence that desiccation has taken place.

2.9.1.4 Corrective Action

If soil has been desiccated to a depth less than or equal to the thickness of a single lift, the desiccated lift may be disked, moistened, and recompact. However, disking may produce large, hard clods of clay that will require pulverization. Also, it should be recognized that if the soil is wetted, time must be allowed for water to be absorbed into the clods of clay and hydration to take place uniformly. For this reason it may be necessary to remove the desiccated soil from the construction area, to process the lift in a separate processing area, and to replace the soil accordingly.

2.9.2 Freezing Temperatures

2.9.2.1 Compacting Frozen Soil

Frozen soil should never be used to construct soil liners. Frozen soils form hard pieces

that cannot be properly remolded and compacted. Inspectors should be on the lookout for frozen chunks of soil when construction takes place in freezing temperatures.

2.9.2.2 Protection After Freezing

Freezing of soil liner materials can produce significant increases in hydraulic conductivity. Soil liners must be protected from freezing before and after construction. If superficial freezing takes place on the surface of a lift of soil, the surface may be scarified and recompacted. If an entire lift has been frozen, the entire lift should be disked, pulverized, and recompacted. If the soil is frozen to a depth greater than one lift, it may be necessary to strip away and replace the frozen material.

2.9.2.3 Investigating Possible Frost Damage

Inspectors usually cannot determine from an examination of the surface the depth to which freezing took place in a completed or partially completed soil liner that has been exposed to freezing. In such cases it may be necessary to investigate the soil liner material for possible frost damage. The extent of damage is difficult to determine. Freezing temperatures cause the development of tiny microcracks in the soil. Soils that have been damaged due to frost action develop fine cracks that lead to the formation of chunks of soil when the soil is excavated. The pushing of a sampling tube into the soil will probably close these cracks and mask the damaging effects of frost upon hydraulic conductivity. The recommended procedure for evaluating possible frost damage to soil liners involves three steps:

1. Measure the water content of the soil within and beneath the zone of suspected frost damage. Density may also be measured, but freeze/thaw has little effect on density and may actually cause an increase in dry unit weight. Freeze/thaw is often accompanied by desiccation; water content measurements will help to determine whether drying has taken place.
2. Investigate the morphology of the soil by digging into the soil and examining its condition. Soil damaged by freezing usually contains hairline cracks, and the soil breaks apart in chunks along larger cracks caused by freeze/thaw. Soil that has not been frozen should not have tiny cracks nor should it break apart in small chunks. The morphology of the soil should be examined by excavating a small pit into the soil liner and peeling off sections from the wall of the pit. One should not attempt to cut pieces from the sidewall; smeared soil will mask cracks. A distinct depth may be obvious; above this depth the soil breaks into chunks along frost-induced cracks, and below this depth there is no evidence of cracks produced by freezing.
3. One or more samples of soil should be carefully hand trimmed for hydraulic conductivity testing. The soil is usually trimmed with the aid of a sharpened section of tube of the appropriate inside diameter. The tube is set on the soil surface with the sharpened end facing downward, soil is trimmed away near the sharpened edge of the trimming ring, the tube is pushed a few millimeters into the soil, and the trimming is repeated. Samples may be taken at several depths to delineate the depth to which freeze/thaw damage occurred. The minimum diameter of a cylindrical test specimen should be 300 mm (12 in.). Small test specimens, e.g., 75 mm (3 in.) diameter specimens, should not be used because freeze/thaw can create morphological structure in the soil on a scale too large to permit representative testing with small samples. Hydraulic conductivity tests should be performed as described in ASTM D-5084. The effective confining stress should not exceed the

smallest vertical effective stress to which the soil will be subjected in the field, which is usually the stress at the beginning of service for liners. If no compressive stress is specified, a value of 35 kPa (5 psi) is recommended for both liner and cover system.

The test pit and all other penetrations should be carefully backfilled by placing soil in lifts and compacting the lifts. The sides of the test pit should be sloped so that the compactor can penetrate through to newly placed material without interference from the walls of the pit.

2.9.2.4 Repair

If it is determined that soil has been damaged by freezing, the damaged material is usually repaired as follows. If damage is restricted to a single lift, the lift may be disked, processed to adjust water content or to reduce clod size if necessary, and recompact. If the damage extends deeper, damaged materials should be excavated and replaced.

2.9.3 Excess Surface Water

In some cases exposed lifts of liner material, or the completed liner, are subjected to heavy rains that soften the soil. Surface water creates a problem if the surface is uneven (e.g., if a footed roller has been used and the surface has not been smooth-rolled with a smooth, steel wheeled roller) -- numerous small puddles of water will develop in the depressions low areas. Puddles of water should be removed before further lifts of material, or other components of the liner or cover system, are constructed. The material should be disked repeatedly to allow the soil to dry, and when the soil is at the proper water content, the soil should be compacted. Alternatively, the wet soil may be removed and replaced.

Even if puddles have not formed, the soils may be too soft to permit construction equipment to operate on the soil without creating ruts. To deal with this problem, the soil may be allowed to dry slightly by natural processes (but care must be taken to ensure that it does not dry too much and does not crack excessively during the drying process). Alternatively, the soil may be disked, allowed to dry while it is periodically disked, and then compacted.

If soil is reworked and recompact, QA/QC tests should be performed at the same frequency as for the rest of the project. However, if the area requiring reworking is very small, e.g., in a sump, tests should be performed in the confined area to confirm proper compaction even if this requires sampling at a greater frequency.

2.10 Test Pads

2.10.1 Purpose of Test Pads

The purpose of a test pad is to verify that the materials and methods of construction proposed for a project will lead to a soil liner with the required large-scale, in-situ, hydraulic conductivity. Unfortunately, it is impractical to perform large-scale hydraulic conductivity tests on the actual soil liner for two reasons: (1) the testing would produce significant physical damage to the liner, and the repair of the damage would be questionable; and (2) the time required to complete the testing would be too long -- the liner could become damaged due to desiccation while one waited for the test results.

A test pad may also be used to demonstrate that unusual materials or construction procedures will work. The process of constructing and testing a test pad is usually a good learning

experience for the contractor and CQC/CQA personnel; overall quality of a project is usually elevated as a result of building and testing the test pad.

A test pad is constructed with the soil liner materials proposed for a project utilizing preprocessing procedures, construction equipment, and construction practices that are proposed for the actual liner. If the required hydraulic conductivity is demonstrated for the test pad, it is assumed that the actual liner will have a similar hydraulic conductivity, provided the actual liner is built of similar materials and to standards that equal or exceed those used in building the test pad. If a test pad is constructed and hydraulic conductivity is verified on the test pad, a key goal of CQA/CQC for the actual liner is to verify that the actual liner is built of similar materials and to standards that equal or exceed those used in building the test pad.

2.10.2 Dimensions

Test pads (Fig. 2.31) normally measure about 10 to 15 m in width by 15 to 30 m in length. The width of the test pad is typically at least four times the width of the compaction equipment, and the length must be adequate for the compactor to reach normal operating speed in the test area. The thickness of a test pad is usually no less than the thickness of the soil liner proposed for a facility but may be as little as 0.6 to 0.9 m (2 to 3 feet) if thicker liners are to be employed at full scale. A freely draining material such as sand is often placed beneath the test pad to provide a known boundary condition in case infiltrating water from a surface hydraulic conductivity test (e.g., sealed double ring infiltrometer) reaches the base of the liner. The drainage layer may be drained with a pipe or other means. However, infiltrating water will not reach the drainage layer if the hydraulic conductivity is very low; the drainage pipe would only convey water if the hydraulic conductivity turns out to be very large. The sand drainage material may not provide adequate foundation support for the first lift of soil liner unless the sand is compacted sufficiently. Also, the first lift of soil liner material on the drainage layer is often viewed as a sacrificial lift and is only compacted nominally to avoid mixing clayey soil in with the drainage material.

2.10.3 Materials

The test pad is constructed of the same materials that are proposed for the actual project. Processing equipment and procedures should be identical, too. The same types of CQC/CQA tests that will be used for the soil liner are performed on the test pad materials. If more than one type of material will be used, one test pad should be constructed for each type of material.

2.10.4 Construction

It is recommended that test strips be built before constructing the test pad. Test strips allow for the detection of obvious problems and provide an opportunity to fine-tune soil specifications, equipment selection, and procedures so that problems are minimized and the probability of the required hydraulic conductivity being achieved in the test pad is maximized. Test strips are typically two lifts thick, one and a half to two equipment widths wide, and about 10 m (30 ft) long.

The test pad is built using the same loose lift thickness, type of compactor, weight of compactor, operating speed, and minimum number of passes that are proposed for the actual soil liner. It is important that the test pad not be built to standards that will exceed those used in building the actual liner. For example, if the test pad is subjected to 15 passes of the compactor, one would want the actual soil liner to be subjected to at least 15 passes as well. It is critical that CQA personnel document the construction practices that are employed in building the test pad. It is best if the same contractor builds the test pad and actual liner so that experience gained from the test pad process is not lost. The same applies to CQC and CQA personnel.

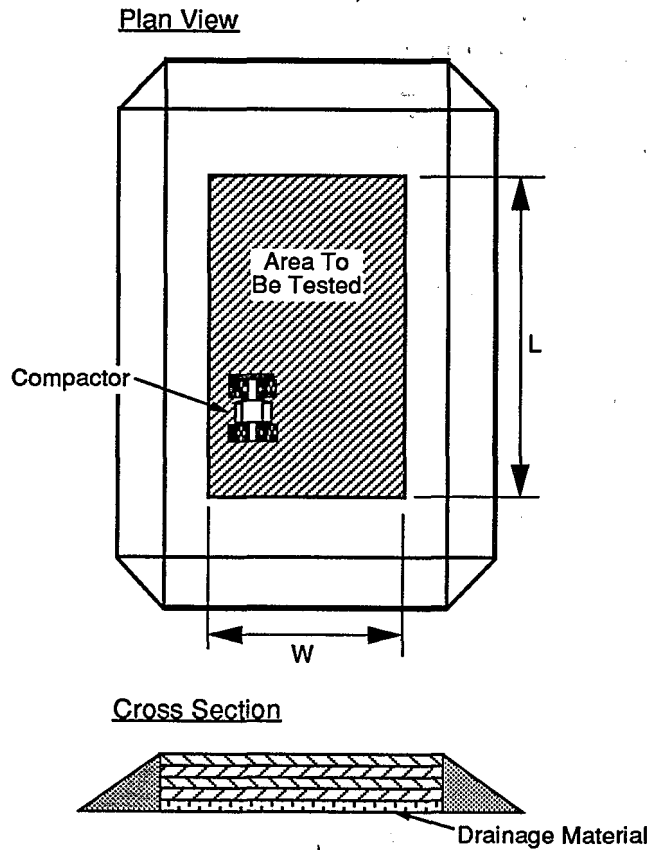

W = 3 Compaction Vehicle Widths, Minimum
 L = A Value No Smaller than W and Sufficient for Equipment
 to Reach Proper Operating Speed in Test Area

Figure 2.31 - Schematic Diagram of Soil Liner Test Pad

2.10.5 Protection

The test pad must be protected from desiccation, freezing, and erosion in the area where in situ hydraulic conductivity testing is planned. The recommended procedure is to cover the test pad with a sheet of white or clear plastic and then either spread a thin layer of soil on the plastic if no rain is anticipated or, if rain may create an undesirably muddy surface, cover the plastic with hay or straw.

2.10.6 Tests and Observations

The same types of CQA tests that are planned for the actual liner are usually performed on the test pad. However, the frequency of testing is usually somewhat greater for the test pad. Material tests such as liquid limit, plastic limit, and percent fines are often performed at the rate of one per lift. Several water content-density tests are usually performed per lift on the compacted soil. A typical rate of testing would be one water content-density test for each 40 m² (400 ft²). The CQA plan should describe the testing frequency for the test pad.

There is a danger in over testing the test pad -- excessive testing could lead to a greater degree of construction control in the test pad than in the actual liner. The purpose of the test pad is to verify that the materials and methods of construction proposed for a project can result in compliance with performance objectives concerning hydraulic conductivity. Too much control over the construction of the test pad runs counter to this objective.

2.10.7 In Situ Hydraulic Conductivity

2.10.7.1 Sealed Double-Ring Infiltrometer

The most common method of measuring in situ hydraulic conductivity on test pads is the sealed double-ring infiltrometer (SDRI). A schematic diagram of the SDRI is shown Fig. 2.32. The test procedure is described in ASTM D-5093.

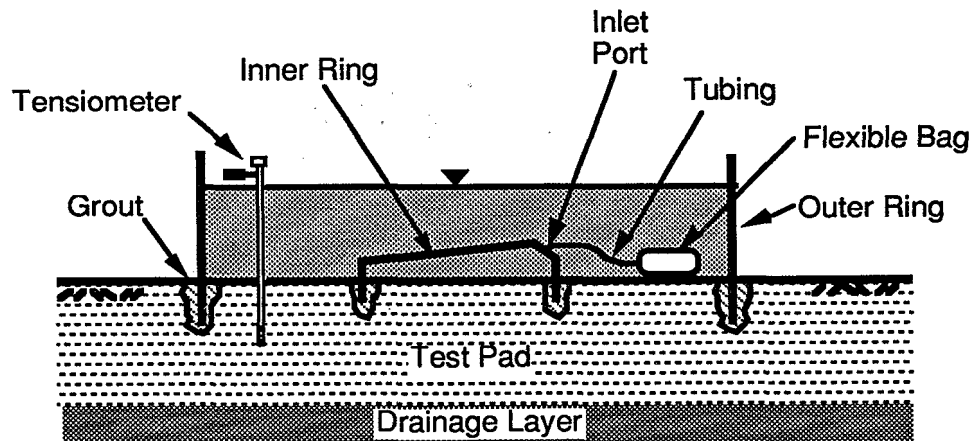

Figure 2.32 - Schematic Diagram of Sealed Double Ring Infiltrometer (SDRI)

With this method, the quantity of water that flows into the test pad over a known period of time is measured. This flow rate, which is called the infiltration rate (I), is computed as follows:

$$I = Q/At \quad (2.5)$$

where Q is the quantity of water entering the surface of the soil through a cross-sectional area A and over a period of time t .

Hydraulic conductivity (K) is computed from the infiltration rate and hydraulic gradient (i) as follows:

$$K = I/i \quad (2.6)$$

Three procedures have been used to compute the hydraulic gradient. The procedures are called (1) apparent gradient method; (2) wetting front method; and (3) suction head method. The equation for computing hydraulic gradient from each method is shown in Fig. 2.33.

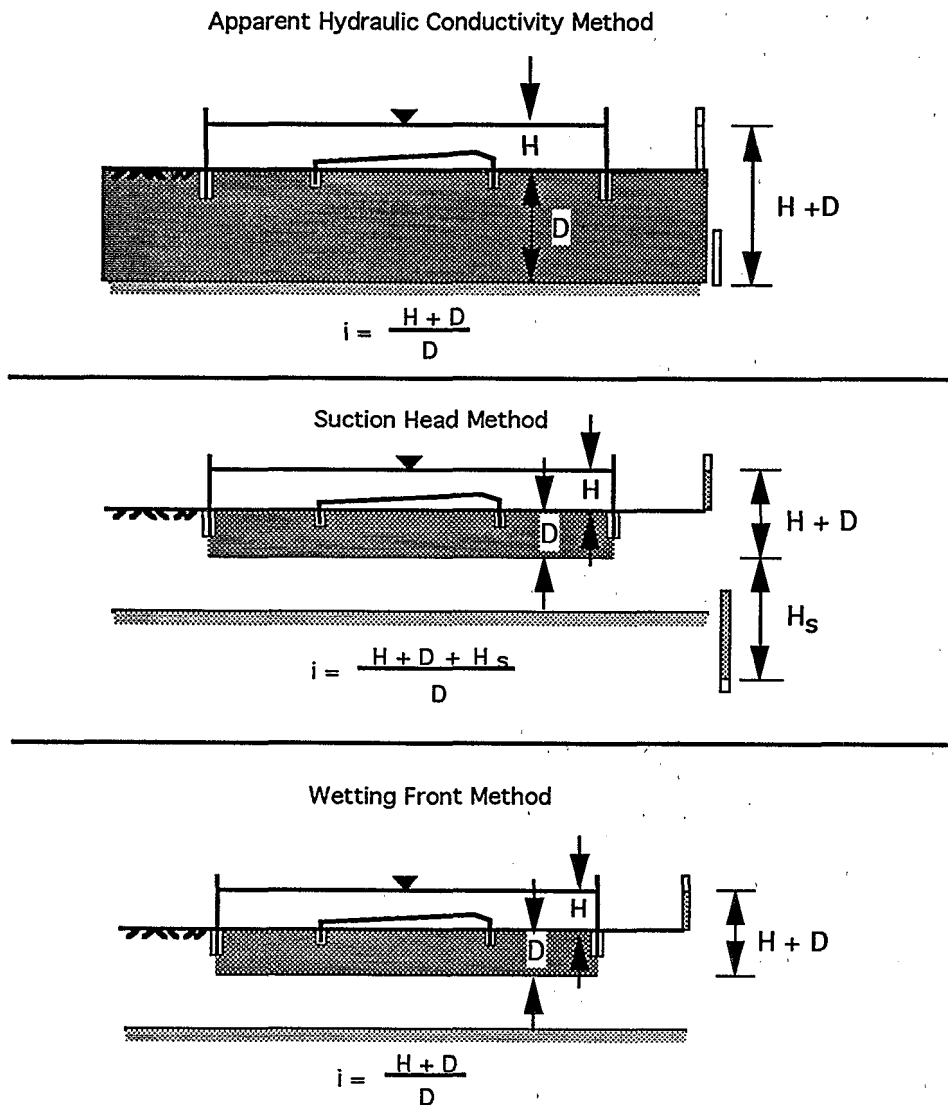

Figure 2.33 - Three Procedures for Computing Hydraulic Gradient from Infiltration Test

The apparent gradient method is the most conservative of the three methods because this method yields the lowest estimate of i and, therefore, the highest estimate of hydraulic conductivity. The apparent gradient method assumes that the test pad is fully soaked with water over the entire depth of the test pad. For relatively permeable test pads, the assumption of full soaking is reasonable, but for soil liners with $K < 1 \times 10^{-7}$ cm/s, the assumption of full soaking is excessively conservative and should not be used unless verified.

The second and most widely used method is the wetting front method. The wetting front is assumed to partly penetrate the test pad (Fig. 2.33) and the water pressure at the wetting front is conservatively assumed to equal atmospheric pressure. Tensiometers are used to monitor the depth of wetting of the soil over time, and the variation of water content with depth is determined at the end of the test. The wetting front method is conservative but in most cases not excessively so. The wetting front method is the method that is usually recommended.

The third method, called the suction head method, is the same as the wetting front method except that the water pressure at the wetting front is not assumed to be atmospheric pressure. The suction head (which is defined as the negative of the pressure head) at the wetting front is H_s and is added to the static head of water in the infiltration ring to calculate hydraulic gradient (Fig. 2.37). The suction head H_s is identical to the wetting front suction head employed in analyzing water infiltration with the Green-Ampt theory. The suction head H_s is not the ambient suction head in the unsaturated soil and is generally very difficult to determine (Brakensiek, 1977). Two techniques available for determining H_s are:

1. Integration of the hydraulic conductivity function (Neuman, 1976):

$$H_s = \int_{h_{sc}}^0 K_r dh_s \quad (2.7)$$

where h_{sc} is the suction head at the initial (presoaked) water content of the soil, K_r is the relative hydraulic conductivity (K at particular suction divided by the value of K at full saturation), and h_s is suction.

2. Direct measurement with air entry permeameter (Daniel, 1989, and references therein).

Reimbold (1988) found that H_s was close to zero for two compacted soil liner materials. Because proper determination of H_s is very difficult, the suction head method cannot be recommended, unless the testing personnel take the time and make the effort to determine H_s properly and reliably.

Corrections may be made to account for various factors. For example, if the soil swells, some of the water that infiltrated into the soil was absorbed into the expanded soil. No consensus exists on various corrections and these should be evaluated case by case.

2.10.7.2 Two-Stage Borehole Test

The two-stage borehole hydraulic conductivity was developed by Boutwell (the test is sometimes called the Boutwell Test) and was under development as an ASTM standard at the time of this writing. The device is installed by drilling a hole (which is typically 100 to 150 mm in diameter), placing a casing in the hole, and sealing the annular space between the casing and borehole with grout as shown in Fig. 2.34. A series of falling head tests is performed and the

hydraulic conductivity from this first stage (k_1) is computed. Stage one is complete when k_1 ceases to change significantly. The maximum vertical hydraulic conductivity may be computed by assuming that the vertical hydraulic conductivity is equal to k_1 . However, the test may be continued for a second stage by removing the top of the casing and extending the hole below the casing as shown in Fig. 2.34. The casing is reassembled, the device is again filled with water, and falling head tests are performed to determine the hydraulic conductivity from stage two (k_2). Both horizontal and vertical hydraulic conductivity may be computed from the values of k_1 and k_2 . Further details on methods of calculation are provided by Boutwell and Tsai (1992), although the reader is advised to refer to the ASTM standard when it becomes available.

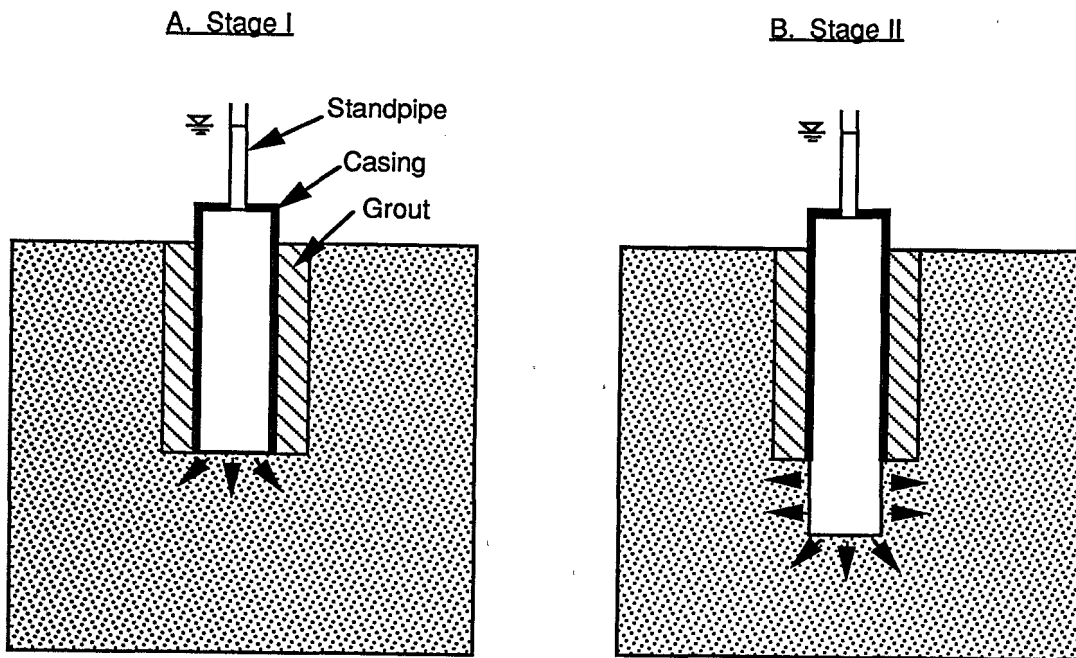

Figure 2.34 - Schematic Diagram of Two-Stage Borehole Test

The two-stage borehole test permeates a smaller volume of soil than the sealed double-ring infiltrometer. The required number of two-stage borehole tests for a test pad is a subject of current research. At the present time, it is recommended that at least 5 two-stage borehole tests be performed on a test pad if the two-stage test is used. If 5 two-stage borehole tests are performed, then one would expect that all five of the measured vertical hydraulic conductivities would be less than or equal to the required maximum hydraulic conductivity for the soil liner.

2.10.7.3 Other Field Tests

Several other methods of in situ hydraulic conductivity testing are available for soil liners. These methods include open infiltrometers, borehole tests with a constant water level in the borehole, porous probes, and air-entry permeameters. The methods are described by Daniel (1989) but are much less commonly used than the SDRI and two-stage borehole test.

2.10.7.4 Laboratory Tests

Laboratory hydraulic conductivity tests may be performed for two reasons:

1. If a very large sample of soil is taken from the field and permeated in the laboratory, the result may be representative of field-scale hydraulic conductivity. The question of how large the laboratory test specimen needs to be is currently a matter of research, but preliminary results indicate that a specimen with a diameter of approximately 300 mm (12 in.) may be sufficiently large (Benson et al., 1993).
2. If laboratory hydraulic conductivity tests are a required component of QA/QC for the actual liner, the same sampling and testing procedures are used for the test pad. Normally, undisturbed soil samples are obtained following the procedures outlined in ASTM D-1587, and soil test specimens with diameters of approximately 75 mm (3 in.) are permeated in flexible-wall permeameters in accordance with ASTM D-5084.

2.10.8 Documentation

A report should be prepared that describes all of the test results from the test pad. The test pad documentation provides a basis for comparison between test pad results and the CQA data developed on an actual construction project.

2.11 Final Approval

Upon completion of the soil liner, the soil liner should be accepted and approved by the CQA engineer prior to deployment or construction of the next overlying layer.

2.12 References

- Albrecht, K .A., and K. Cartwright (1989), "Infiltration and Hydraulic Conductivity of a Compacted Earthen Liner," *Ground Water*, Vol. 27, No. 1, pp. 14-19.
- Alther, G. R. (1983), "The Methylene Blue Test for Bentonite Liner Quality Control," *Geotechnical Testing Journal*, Vol. 6, No. 3, pp. 133-143.
- ASTM D-422, "Particle-Size Analysis of Soils"
- ASTM D-698, "Laboratory Compaction Characteristics of Soils Using Modified Effort (12,400 ft-lbf/ft³ (600 kN-m/m³))"
- ASTM D-1140, "Amount of Material in Soils Finer than the No. 200 (75- μ m) Sieve"

- ASTM D-1556, "Density and Unit Weight of Soil In Place by Sand-Cone Method"
- ASTM D-1557, "Laboratory Compaction Characteristics of Soils Using Standard Effort (56,000 ft-lbf/ft³ (2,700 kN-m/m³))"
- ASTM D-1587, "Thin-Walled Tube Sampling of Soils"
- ASTM D-2167, "Density and Unit Weight of Soil In Place by Rubber Balloon Method"
- ASTM D-2216, "Laboratory Determination of Water (Moisture) Content of Soil and Rock"
- ASTM D-2487, "Classification of Soils for Engineering Purposes (Unified Soil Classification System)"
- ASTM D-2488, "Description and Identification of Soils (Visual-Manual Procedure)"
- ASTM D-2922, "Density of Soil and Soil-Aggregate In Place by Nuclear Methods (Shallow Depth)"
- ASTM D-2937, "Density and Unit Weight of Soil In Place by Drive-Cylinder Method"
- ASTM D-3017, "Water Content of Soil and Rock In Place by Nuclear Methods (Shallow Depth)"
- ASTM D-4220, "Preserving and Transporting Soil Samples"
- ASTM D-4318, "Liquid Limit, Plastic Limit, and Plasticity Index of Soils"
- ASTM D-4643, "Determination of Water (Moisture) Content of Soil by Microwave Oven Method"
- ASTM D-4944, "Field Determination of Water (Moisture) Content of Soil by Calcium Carbide Gas Pressure Tester Method"
- ASTM D-4959, "Determination of Water (Moisture) Content of Soil by Direct Heating Method"
- ASTM D-5080, "Rapid Determination of Percent Compaction"
- ASTM D-5084, "Measurement of Hydraulic Conductivity of Saturated Porous Materials Using a Flexible Wall Permeameter"
- ASTM D-5093, "Field Measurement of Infiltration Rate Using a Double-Ring Infiltrometer with a Sealed Inner Ring"
- ASTM E-946, "Water Adsorption of Bentonite by the Porous Plate Method"
- Benson, C. H., and D.E. Daniel (1990), "Influence of Clods on Hydraulic Conductivity of Compacted Clay," *Journal of Geotechnical Engineering*, Vol. 116, No. 8, pp. 1231-1248.
- Benson, C. H., and G. P. Boutwell (1992), "Compaction Control and Scale-Dependent Hydraulic Conductivity of Clay Liners," *Proceedings, Fifteenth Annual Madison Waste Conference*, Univ. of Wisconsin, Madison, Wisconsin, pp. 62-83..
- Benson, C. H., Zhai, H., and Rashad, S. M. (1992), "Assessment of Construction Quality

Control Measurements and Sampling Frequencies for Compacted Soil Liners," Environmental Geotechnics Report No. 92-6, University of Wisconsin, Department of Civil and Environmental Engineering, Madison, Wisconsin, 100p.

- Benson, C. H., Hardianto, F. S., and Motan, E. S. (1993), "Representative Sample Size for Hydraulic Conductivity Assessment of Compacted Soil Liners," *Hydraulic Conductivity and Waste Contaminant Transport in Soils, ASTM STP 1142*, D. E. Daniel and S. J. Trautwein (Eds.), American Society for Testing and Materials, Philadelphia, (in review).
- Boutwell, G., and Hedges, C. (1989), "Evaluation of Waste-Retention Liners by Multivariate Statistics," *Proceedings of the Twelfth International Conference on Soil Mechanics and Foundation Engineering*, A. A. Balkema, Rotterdam, Vol. 2, pp. 815-818.1
- Boutwell, G. P., and Tsai, C. N. (1992), "The Two-Stage Field Permeability Test for Clay Liners," *Geotechnical News*, Vol. 10, No. 2, pp. 32-34.
- Brakensiek, D.L. (1977), "Estimating the Effective Capillary Pressure in the Green and Ampt Infiltration Equation," *Water Resources Research*, Vol. 12, No. 3, pp. 680-681.
- Brown, R. K. (1992), Personal Communication.
- Daniel, D.E. (1989), "In Situ Hydraulic Conductivity Tests for Compacted Clay," *Journal of Geotechnical Engineering*, Vol. 115, No. 9, pp. 1205-1226.
- Daniel, D.E. (1990), "Summary Review of Construction Quality Control for Compacted Soil Liners," in *Waste Containment Systems: Construction, Regulation, and Performance*, R. Bonaparte (Ed.), American Society of Civil Engineers, New York, pp. 175-189.
- Daniel, D.E., and C. H. Benson (1990), "Water Content - Density Criteria for Compacted Soil Liners," *Journal of Geotechnical Engineering*, Vol. 116, No. 12, pp. 1811-1830.
- Elsbury, B. R., Daniel, D. E., Sraders, G. A., and Anderson, D. C. (1990), "Lessons Learned from Compacted Clay Liner," *Journal of Geotechnical Engineering*, Vol. 116, No. 11, pp. 1641-1660.
- Hilf, J. W. (1991), "Compacted Fill," in *Foundation Engineering Handbook*, H. Y. Fang (Ed.), Van Nostrand Reinhold, New York, pp. 249-316.
- Lambe, T. W., and Whitman, R. V. (1969), *Soil Mechanics*, John Wiley & Sons, New York, 533 p.
- Mitchell, J. K., Hooper, D. R., and Campanella, R. G. (1965), "Permeability of Compacted Clay," *Journal of the Soil Mechanics and Foundations Division*, ASCE, Vol. 91, No. SM4, pp. 41-65.
- Mundell, J. A., and Bailey, B. (1985), "The Design and Testing of a Compacted Clay Barrier Layer to Limit Percolation through Landfill Covers," *Hydraulic Barriers in Soil and Rock, ASTM STP 874*, A. I. Johnson et al. (Eds.), American Society for Testing and Materials, Philadelphia, pp. 246-262.
- Neuman, S.P. (1976), "Wetting Front Pressure Head in the Infiltration Model of Green and Ampt," *Water Resources Research*, Vol. 11, No. 3, pp. 564-565.

- Noorany, I. (1990), "Variability in Compaction Control," *Journal of Geotechnical Engineering*, Vol. 116, No. 7, pp. 1132-1136.
- Reimbold, M.W. (1988), "An Evaluation of Models for Predicting Infiltration Rates in Unsaturated Compacted Clay Soils," M.S. Thesis, The University of Texas at Austin, Austin, Texas, 128 p.
- Richardson, G. N. (1992), "Construction Quality Management for Remedial Action and Remedial Design Waste Containment Systems," U.S. Environmental Protection Agency, EPA/540/R-92/073, Washington, DC.
- Schmertmann, J.H. (1989), "Density Tests Above Zero Air Voids Line," *Journal of Geotechnical Engineering*, Vol. 115, No. 7, pp. 1003-1018.
- Shelley, T. L., and Daniel, D. E. (1993), "Effect of Gravel on Hydraulic Conductivity of Compacted Soil Liners," *Journal of Geotechnical Engineering*, Vol. 119, No. 1, pp. 54-68.
- Turnbull, W. J., Compton, J. P., and R. G. Ahlvin (1966), "Quality Control of Compacted Earthwork," *Journal of the Soil Mechanics and Foundations Division*, ASCE, Vol. 92, No. SM1, pp. 93-103.
- U.S. Army Corps of Engineers (1970), "Laboratory Soils Testing," Office of the Chief of Engineers, Washington, DC, EM1110-2-1906.

Chapter 3

Geomembranes

This chapter focuses upon the manufacturing quality assurance (MQA) aspects of geomembrane formulation, manufacture and fabrication, and on the construction quality assurance (CQA) of the complete installation of the geomembranes in the field. Note that in previous literature these liner materials were called *flexible membrane liners (FML's)*, but the more generic name of geomembranes will be used throughout this document.

The geomembrane materials discussed in this document are those used most often at the time of writing. However, there are other polymer types that are also used. Aspects of quality assurance of these materials can be inferred from information contained in this document. In the future, new materials will be developed and the reader is advised to seek the appropriate information for evaluation of such new or modified materials.

3.1 Types of Geomembranes and Their Formulations

It must be recognized that all geomembranes are actually formulations of a parent resin (from which they derive their generic name) and several other ingredients. The most commonly used geomembranes for solid and liquid waste containment are listed below. They are listed according to their commonly referenced acronyms which will be explained in the text to follow. Other geomembranes in limited use or under initial field trials will also be mentioned where appropriate but will be covered in less detail than the types listed below.

Table 3.1 - Types of Commonly Used Geomembranes and Their Approximate Weight Percentage Formulations*

| Geomembrane Type | Resin | Plasticizer | Filler | Carbon Black or Pigment | Additives |
|--------------------------|-------|-------------|--------|-------------------------|-----------|
| HDPE | 95-98 | 0 | 0 | 2-3 | 0.25-1.0 |
| VLDPE | 94-96 | 0 | 0 | 2-3 | 1-4 |
| Other Extruded Types ** | 95-98 | 0 | 0 | 2-3 | 1-2 |
| PVC | 50-70 | 25-35 | 0-10 | 2-5 | 2-5 |
| CSPE*** | 40-60 | 0 | 40-50 | 5-40 | 5-15 |
| Other Calendered Types** | 40-97 | 0-30 | 0-50 | 2-30 | 0-7 |

* Note that this Table should not be directly used for MQA or CQA Documents, since neither the Agency nor the Authors of the Report intend to provide prescriptive formulations for manufacturers and their respective geomembranes.

** Other geomembranes than those listed in this Table will be described in the appropriate Section.

*** CSPE geomembranes are generally fabric (scrim) reinforced.

It must be recognized that Table 3.1 and the references to it in the text to follow are meant to reflect on the current state-of-the-art. The values mentioned are not meant to be prescriptive and future research and development may result in substantial changes.

3.1.1 High Density Polyethylene (HDPE)

As noted in Table 3.1, high density polyethylene (HDPE) geomembranes are made from polyethylene resin, carbon black and additives.

3.1.1.1 Resin

The polyethylene resin used for HDPE geomembranes is prepared by low pressure polymerization of ethylene as the principal monomer and having the characteristics listed in ASTM D-1248. As seen in Fig. 3.1, the resin is usually supplied to the manufacturer or formulator in an opaque pellet form.

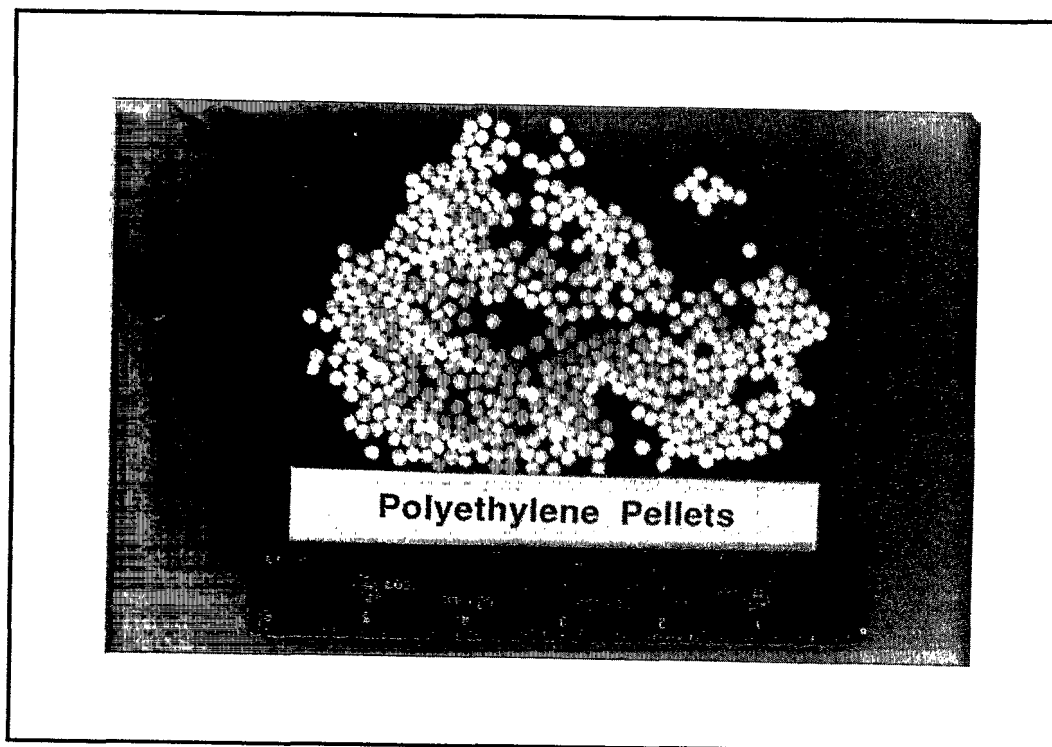

Figure 3.1 - HDPE Resin Pellets

Regarding the preparation of a specification or MQA document for the resin component of an HDPE geomembrane, the following items should be considered:

1. The polyethylene resin, which is covered in ASTM D-1248, is to be made from virgin, uncontaminated ingredients.
2. The quality control tests performed on the incoming resin will typically be density (either ASTM D-792 or D1505) and melt flow index which is ASTM D-1238.

3. Typical natural densities of the various resins used are between 0.934 and 0.940 g/cc. Note that according to ASTM D-1248 this is Type II polyethylene and is classified as medium density polyethylene.
4. Typical melt flow index values are between 0.1 and 1.0 g/10 min as per ASTM D-1238, Cond. 190/2.16.
5. Other tests which can be considered for quality control of the resin are melt flow ratio (comparing high-to-low weight melt flow values), notched constant tensile load test as per ASTM D-5397, and a single point notched constant load test, see Hsuan and Koerner (1992) for details. The latter tests would require a plaque to be made from the resin from which test specimens are taken. The single point notched constant load test is then performed at 30% yield strength and the test specimens are currently recommended not to fail within 200 hours.
6. Additional quality control certification procedures by the manufacturer (if any) should be implemented and followed.
7. The frequency of performing each of the preceding tests should be covered in the MQC plan and it should be implemented and followed.
8. An HDPE geomembrane formulation should consist of at least 97% of polyethylene resin. As seen in Table 3.1 the balance is carbon black and additives. No fillers, extenders, or other materials should be mixed into the formulation.
9. It should be noted that by adding carbon black and additives to the resin, the density of the final formulation is generally 0.941 to 0.954 g/cc. Since this numeric value is now in the high density polyethylene category according to ASTM D-1248, geomembranes of this type are commonly referred to as high density polyethylene (HDPE).
10. Regrind or rework chips (which have been previously processed by the same manufacturer but never used as a geomembrane, or other) are often added to the extruder during processing. This topic will be discussed in section 3.2.2.
11. Reclaimed material (which is polymer material that has seen previous service life and is recycled) should never be allowed in the formulation in any quantity. This topic will be discussed in section 3.2.2.

3.1.1.2 Carbon Black

Carbon black is added into an HDPE geomembrane formulation for general stabilization purposes, particularly for ultraviolet light stabilization. It is sometimes added in a powder form at the geomembrane manufacturing facility during processing, or (generally) it is added as a preformulated concentrate in pellet form. The latter is the usual case. Figure 3.2 shows photographs of carbon black powder and of concentrate pellets consisting of approximately 25% carbon black in a polyethylene resin carrier.

Regarding the preparation of a specification or MQA document for the carbon black component of HDPE geomembranes, the following items should be considered.

1. The carbon black used in HDPE geomembranes should be a Group 3 category, or lower, as defined in ASTM D-1765.

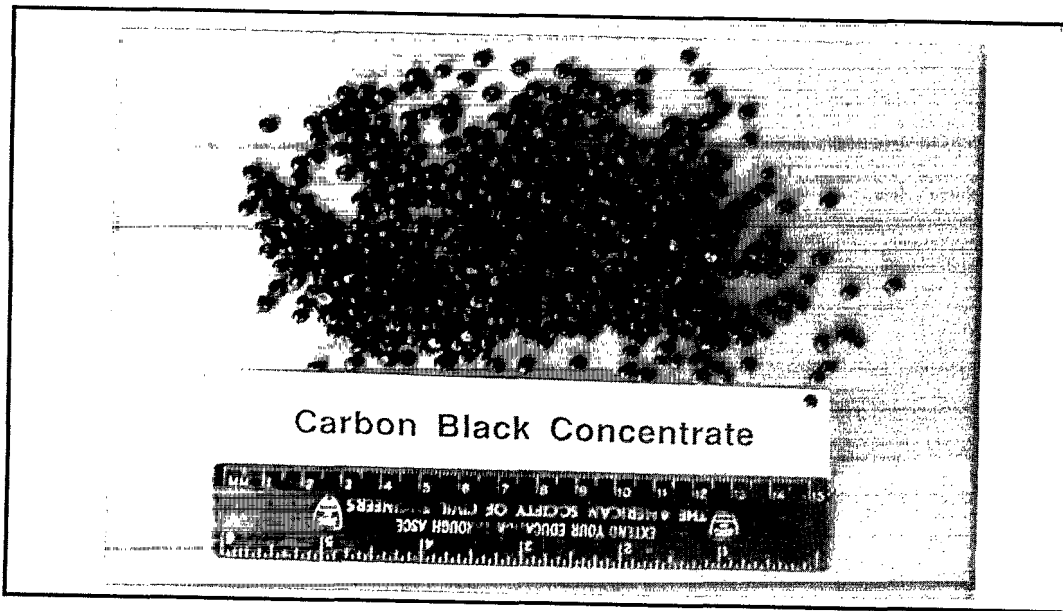
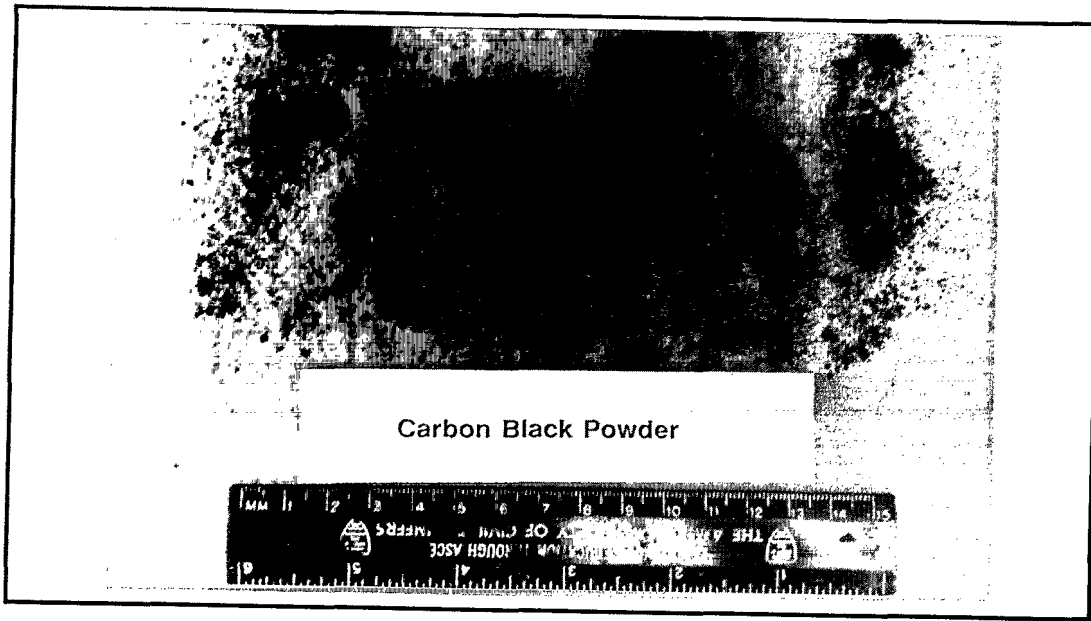

Figure 3.2 - Carbon Black in Particulate Form (Upper Photograph) and as a Concentrate (Lower Photograph)

2. Typical amounts of carbon black are from 2.0% to 3.0% by weight per ASTM D-1603. Values less than 2.0% do not appear to give adequate long-term ultraviolet protection; values greater than 3.0% begin to adversely effect physical and mechanical properties.
3. Current carbon black dispersion requirements in the final HDPE geomembrane are usually required to be A-1, A-2 or B-1 according to ASTM D-2663. Sample preparation is via ASTM D-3015. It should be noted, however, that this test method is directed at polymeric materials containing relatively large amounts of carbon black, e.g., thermoset elastomers with carbon black contents of approximately 18% by volume. ASTM D-35 Committee on Geosynthetics has a Task Group formulating a new standard focused at carbon black dispersion for formulations containing less than 5% carbon black. Thus this standard will be applicable for the 2 to 3% carbon black currently used in polyethylene formulations.
4. In the event that the carbon black is mixed into the formulation in the form of a concentrate rather than a powder, the carrier resin of the concentrate should be the same generic type as the base polyethylene resin.

3.1.1.3 Additives

Additives are introduced into an HDPE geomembrane formulation for the purposes of oxidation prevention, long-term durability and as a lubricant and/or processing aid during manufacturing. It is quite difficult to write a specification for HDPE geomembranes around a particular additive, or group of additives, because they are generally proprietary. Furthermore, there is research and development ongoing in this area and thus additives are subject to change over time.

If additives are included in a specification or MQA document, the description must be very general as to the type and amount. However, the amount can probably be bracketed as to an upper value.

1. The nature of the additive package used in the HDPE compound may be requested of the manufacturer.
2. The maximum amount of additives in a particular formulation should not exceed 1.0% by weight.

3.1.2 Very Low Density Polyethylene (VLDPE)

As seen in Table 3.1, very low density polyethylene (VLDPE) geomembranes are made from polyethylene resin, carbon black and additives. It should be noted that there are similarities between VLDPE and certain types of linear low density polyethylene (LLDPE). The linear structure and lack of long-chain branching in both LLDPE and VLDPE arise from their similar polymerization mechanisms although the catalyst technology is different. In the low-pressure polymerization of LLDPE, the random incorporation of alpha olefin comonomers produces sufficient short-chain branching to yield densities in the range of 0.915 to 0.930 g/cc. The even lower densities of VLDPE resins (from 0.890 to 0.912 g/cc) are achieved by adding more comonomer (which produces more short-chain branching than occurs in LLDPE, and thus a lower level of crystallinity) and using proprietary catalysts and reactor technology. Since VLDPE is more commonly used than LLDPE for geomembranes in waste containment applications, this section is written around VLDPE. It can be used for LLDPE if the density is at the low end of the above mentioned range. The situation is under discussion by many groups as of the writing of this

document.

3.1.2.1 Resin

The polyethylene resin used for VLDPE geomembranes is a linear polymer of ethylene with other alpha-olefins. As with HDPE, the resin is generally supplied to the manufacturer in the form of pellets, recall Fig. 3.1.

Some specification or MQA document items for VLDPE resins follow:

1. The very low density polyethylene resin is to be made from completely virgin materials. The natural density of the resin is less than 0.912 g/cc, however, a unique category is not yet designated by ASTM.
2. A VLDPE geomembrane formulation should consist of approximately 94-96% polymer resin. As seen in Table 3.1, the balance is carbon black and additives.
3. Typical quality control tests for VLDPE resin will be density, via ASTM D-792 or D1505, and melt flow index via ASTM D-1238.
4. Additional quality control certification procedures of the manufacturer (if any) should be implemented and followed.
5. The frequency of performing each of the preceding tests should be covered in the MQC plan and it should be implemented and followed.
6. Regrind or rework chips (which have been previously processed by the same manufacturer but never used as a geomembrane, or other) are often added to the formulation during processing. This topic will be discussed in section 3.2.2.
7. Reclaimed material (which is polymer that has seen previous service life and is recycled) should never be allowed in any quantity. This topic will be discussed in section 3.2.2.

3.1.2.2 Carbon Black

Carbon black is added to VLDPE geomembrane formulations for general stabilization purposes, particularly for ultraviolet light stabilization. It is added either in a powder form at the geomembrane manufacturing facility, or it is added as a preformulated concentrate in pellet form, recall Fig. 3.2.

Some items to be included in a specification or MQA document follow:

1. The carbon black used in VLDPE geomembranes should be a Group 3 category, or lower, as defined in ASTM D-1765.
2. Typical amounts of carbon black are from 2.0% to 3.0% by weight as per ASTM D-1603. Values less than 2.0% do not appear to give adequate long-term ultraviolet protection, while values greater than 3.0% begin to negatively effect physical and mechanical properties.
3. Current carbon black dispersion requirements in the final HDPE geomembrane are usually required to be A-1, A-2 or B-1 according to ASTM D-2663⁽⁸⁾. Sample

preparation is via ASTM D-3015. It should be noted, however, that this test method was directed at polymeric materials containing relatively large amounts of carbon black, e.g., thermoset elastomers with carbon black contents of approximately 18% by volume. ASTM D-35 Committee on Geosynthetics has a Task Group formulating a new standard focused at carbon black dispersion for formulations containing less than 5% carbon black which is the amount used in formulation of VLDPE geomembranes.

4. In the event that the carbon black is mixed into the formulation in the form of a concentrate rather than a powder, the carrier resin of the concentrate should be identified.

3.1.2.3 Additives

Additives are introduced into a VLDPE formulation for the purposes of anti-oxidation, long-term durability and as a lubricant and/or processing aid during manufacturing. It is quite difficult to write a specification for VLDPE geomembranes around a particular additive, or group of additives, because they are generally proprietary. Furthermore, there is research and development ongoing in this area and thus additives are subject to change over time.

If additives were included in a specification or MQA document, the description must be very general as to the type and amount. However, the amount can probably be bracketed as to an upper value.

1. The nature of the additive package used in the VLDPE compound may be requested of the manufacturer.
2. The maximum amount of additives in a particular formulation should not exceed 2.0% for smooth sheet or 4.0% for textured sheet by weight.

3.1.3 Other Extruded Geomembranes

Recently, there have been developed other variations of extruded geomembranes. Four have seen commercialization and will be briefly mentioned.

One variation is a coextruded light colored surface layer onto a black base layer for the purpose of reduced surface temperatures when the geomembrane is exposed for a long period of time. The usual application for this material is as a liner for surface impoundments which have no soil covering or sacrificial sheet covering. In the formulation of the light colored surface layer the carbon black is replaced by a pigment (often metal oxides, such as titanium dioxide) which acts as an ultraviolet screening agent. This results in a white, or other light colored surface. The coextruded surface layer is usually relatively thin, e.g., 5 to 10 percent of the total geomembrane's thickness.

A second coextrusion variation is HDPE/VLDPE/HDPE sheet where the two surface layers of HDPE are relatively thin with respect to the VLDPE core. Thickness percentages of 20/60/20 are sometimes used. The interface of these coextruded layers cannot be visually distinguished since the polymers merge into one another while they are in the molten state, i.e., such geomembranes are not laminated together after processing, but are coextruded during processing.

A third variation of coextrusion is to add a foaming agent, such as nitrogen gas, into the surface layer extruder(s). This foaming agent expands and bursts at the surface of the sheet as it cools. The resulting surface is very rough and is generally referred to as *textured*. This variation will be described in Sections 3.2.3.4 and 3.2.4.4 for HDPE and VLDPE, respectively.

A fourth variation of extruded geomembranes is a generic polymer group under the classification of fully crosslinked elastomeric alloys (FCEA). This group of polymers is described in ASTM D-5046. The particular geomembrane type that has been used in waste containment applications is a thermoplastic elastomeric alloy of polypropylene (PP) and ethylene-propylene diene monomer (EPDM). The EPDM is fully crosslinked and suspended in a PP matrix in a process called dynamic vulcanization. The mixed polymer is extruded in a manner similar to the geomembrane types discussed in this section.

3.1.4 Polyvinyl Chloride (PVC)

As seen in Table 3.1, polyvinyl chloride (PVC) geomembranes are made from polyvinyl chloride resin, plasticizer(s), fillers and additives.

3.1.4.1 Resin

The polyvinyl chloride resin used for PVC geomembranes is made by cracking ethylene dichloride into a vinyl chloride monomer. It is then polymerized to make PVC resin. The PVC resin (in the form of a white powder) is then compounded with other components to form a PVC compound.

In the preparation of a specification or MQA document, the following items concerning the PVC resin should be considered.

1. The polyvinyl chloride resin should be made from completely virgin materials.
2. A PVC compound will generally consist of 50-70% PVC resin, by weight.
3. Typical quality control tests on the resin powder will be contamination, relative viscosity, resin gels, color and dry time. The specific test procedures will be specified by the manufacturer. Often they are other than ASTM tests.
4. The frequency of performing each of the preceding tests should be covered in the MQC plan and it should be implemented and followed.
5. Quality control certification procedures used by the manufacturer should be implemented and followed.

3.1.4.2 Plasticizer

Plasticizers are added to PVC formulations to impart flexibility, improve handling and modify physical and mechanical properties. When blended with the PVC resin the plasticizer(s) must be completely mixed into the resin. Since the resin is a powder, and the plasticizers are liquid, mixing of the two components continues until the liquid is completely absorbed by the powder. The result is usually a powder which can be readily conveyed. However, it is also possible to wet blend with acceptable results. There are two general categories of possible plasticizers; monomeric plasticizers and polymeric plasticizers. There are many specific types within each category. For example, monomeric plasticizers are sometimes phthalates, epoxides and phosphates, while polymeric plasticizers are sometimes polyesters, ethylene copolymers and nitrile rubber.

For a specification or MQA document written around PVC plasticizer(s), the following items should be considered.

1. If more than one type of plasticizer is used in a PVC formulation they must be compatible with one another.
2. The plasticizer(s) in a PVC compound are generally from 25-35% of the total compound by weight.
3. The exact type of plasticizer(s) used by the manufacturers are rarely identified. This is industry-wide practice and due to the long history of PVC is generally considered to be acceptable.
4. The plasticizer(s) should be certified by the manufacturer as having a successful past performance or as having been used on a specific number of projects.

3.1.4.3 Filler

The filler used in a PVC formulation is a relatively small component (recall Table 3.1), and (if used at all) is generally not identified. Calcium carbonate, in powder form, has been used but other options also exist. Certification as to successful past performance could be requested.

3.1.4.4 Additives

Other additives for the purpose of ease of manufacturing, coloring and stabilization are also added to the formulation. They are generally not identified. Certification as to successful past performance may be requested.

3.1.5 Chlorosulfonated Polyethylene (CSPE-R)

As seen in Table 3.1, chlorosulfonated polyethylene (CSPE) geomembranes consist of chlorosulfonated polyethylene resin, fillers, carbon black (or colorants) and additives. The finished geomembrane is usually fabricated with a fabric reinforcement, called a "scrim", between the individual plys of the material. It is then designated as CSPE-R.

3.1.5.1 Resin

There are two different types of chlorosulfonated polyethylene resin used to make CSPE geomembranes. One is a completely amorphous polymer while the other is a thermoplastic material containing a controlled amount of crystallinity to provide useful physical properties in the uncured state while maintaining flexibility without the need of any plasticizers. The second type is generally used to manufacture geomembranes. CSPE is made directly from branched polyethylene by adding chlorine and sulfur dioxide. The chlorosulfonic groups act as preferred cross-linking sites during the polymer aging process. In the typical commercial polymer there is one chlorosulfonyl group for each 200 backbone carbon atoms.

CSPE resin pieces usually arrive at the sheet manufacturing facility in large cartons. They are somewhat pillow shaped (about 1 cm diameter) and 2 cm in length. The resin pieces (see Fig. 3.3) are relatively spongy in their resistance to finger pressure. Alternatively, CSPE can be premixed with carbon black in slab form which is then referred to as a master batch. The master batch is usually made by a formulator and shipped to the manufacturing facility in a prepared form.

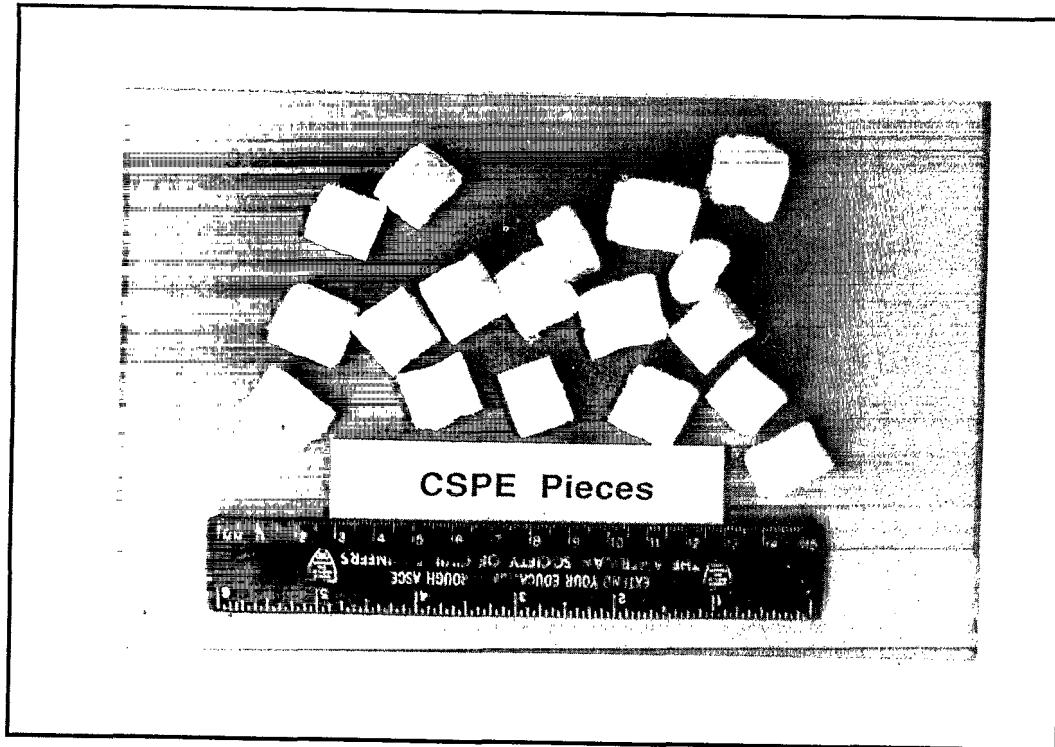

Fig. 3.3 - CSPE Resin Pieces

In preparation of a specification or MQA document, the following items concerning the CSPE resin should be considered.

1. The CSPE resin should be made from completely virgin materials.
2. The formulation will usually be based on 40 to 60% of resin, by weight.
3. Typical MQC tests on the CSPE resin will be Mooney viscosity, chlorine content, sulfur content and a series of vulcanization properties (e.g., rheometry and high temperature behavior).
4. The CSPE resin can be premixed with carbon black in slab form (referred to as a “master batch”) and shipped to the manufacturer's facility.
5. Additional quality control certification procedures used by the manufacturer should be implemented and followed.
6. The frequency of performing each of the preceding tests should be covered in the MQC plan and it should be implemented and followed.

3.1.5.2 Carbon Black

The amount of carbon black in CSPE geomembranes varies from 5 to 36%. The carbon black functions as an ultraviolet light blocking agent, as a filler and aids in processing. The usual types of carbon black used in CSPE formulations are N 630, N 774, N 762 and N 990 as per ASTM D-1765. When low percentages of carbon black are used N 110 to N 220 should be used. When the carbon black is premixed with the resin and produced in the form of a master batch of pellets, it is fed directly into the mixer with the other components, such as fillers, stabilizers and processing aids.

A specification on carbon black in CSPE geomembranes, could be framed around the type and amount of carbon black as just described, but this is rarely the case. Typical MQC certification procedures should be available and implemented.

3.1.5.3 Fillers

The purposes of blending fillers into the CSPE compound are to provide workability and processability. The common types of fillers are clay and calcium carbonate. Both are added in powder form and in quantities ranging from 40 to 50%.

Specifications are rarely written around this aspect of the material, however MQC certification procedures should be available and implemented.

3.1.5.4 Additives

Additives are used in CSPE compounds for the purpose of stabilization which is used to distinguish the various grades. The industrial grade of CSPE geomembranes uses lead oxide as a stabilizer, whereas the potable water grade uses magnesium oxide or magnesium hydroxide. These stabilizers function as acid acceptors during the polymer aging process. During aging, hydrogen chloride or sulfur dioxide releases from the polymer and the metal oxides react with these substances inducing cross linking over time.

Specifications are rarely written around the type and quantity of additives used in CSPE, however MQC certification procedures should be written around each additive, be available and be implemented.

3.1.5.5 Reinforcing Scrim

CSPE geomembranes are usually fabricated with a reinforcing "scrim" between two plies of polymer sheets. This results in a three-ply laminated geomembrane consisting of geomembrane, scrim, geomembrane which is sealed together, under pressure, to form a unitized system. The geomembrane is said to be reinforced and then carries the designation CSPE-R. Other options of multiple plies are also available. The scrim imparts dimensional stability to the material which is important during storage, placement and seaming. It also imparts a major increase in mechanical properties over the unreinforced type, particularly in the tensile strength, modulus of elasticity and tear resistance of the final geomembrane.

The reinforcing scrim for CSPE geomembranes is a woven fabric made from polyester yarns in a standard "basket" weave. Note that there are usually many fine fibers (of very fine diameter) per individual yarn, e.g., 100 to 200 fibers per yarn depending on the desired strength. The yarns, or "strands" as they are referenced in the industry, are spaced close enough to one another to achieve the desired properties, but far apart enough to allow open space between them

so that the opposing geomembrane sheet surfaces can adhere together. This is sometimes referred to as “strike-through” and is measured by a ply-adhesion test. The designation of reinforcing scrim is based on the number of yarns, or strands, per inch of woven fabric. The general range is from 6 x 6 to 20 x 20, with 10 x 10 being the most common. A 10 x 10 scrim refers to 10 strands per inch in the machine (or warp) direction and an equal number of 10 strands per inch in the cross machine (or weft) direction.

It must also be mentioned that the polyester scrim yarns must be coated for them to have good bonding to the upper and lower CSPE sheets. Various coatings, including latex, polyvinyl chloride and others, have been used. The exact formulation of the coating material (or “ply enhancer”) is usually proprietary.

Regarding a specification or MQA document for the fabric scrim in CSPE-R geomembranes the following applies.

1. The type of polymer used for the scrim is usually specified as polyester, although nylon has been used in the past. It should be identified accordingly.
2. The strength of the fabric scrim can be specified and, when done, is best accomplished in tensile strength units of pounds per individual yarn rather than individual fiber strength.
3. The strike-through is indirectly quantified in specifications on the basis of ply adhesion requirements. This will be discussed later.

3.1.6 Other Calendered Geomembranes

Within the category of calendered geomembranes there are other types that have not been described thus far. They will be briefly noted here along with similarities and/or differences to those just described.

Chlorinated polyethylene (CPE) has been used as a polymer resin in the past for either non-reinforced or scrim reinforced geomembranes. Its production and ingredients are similar to CSPE, or CSPE-R, with the obvious exception of the nature of the resin itself. In contrast to CSPE, CPE contains no sulfur in its formulation.

Ethylene interpolymer alloy (EIA) is always used as a reinforced geomembrane, thus EIA-R is its proper designation. The resin is a blend of ethylene vinyl acetate and polyvinyl chloride resulting in a thermoplastic elastomer. The fabric reinforcement is a tightly woven polyester which requires the polymer to be individually spread coated on both sides of the fabric. Note, however, that there are other related products being developed under different trademarks in this general category.

Among the newer geomembranes is polypropylene (PP) which is a very flexible olefinic polymer based on new polypropylene resin technology. This polymer has been converted into sheet by calendering, with and without scrim reinforcement, and by flat die and blown film extrusion processes. Factory fabrication of large panels is possible. The initial field trials of this type of geomembrane are currently ongoing.

3.2 Manufacturing

Once the specific type of geomembrane formulation that is specified has been thoroughly

mixed it is then manufactured into a continuous sheet. The two major processes used for manufacturing of the various types of sheets of geomembranes are variations of either extrusion (e.g., for HDPE, VLDPE, and LLDPE) or calendering (e.g., for PVC, CSPE and PP). Spread coating (the least used process) will be briefly mentioned in section 3.2.8.

3.2.1 Blending, Compounding, Mixing and/or Masticating

Blending, compounding, mixing and/or masticating of the various components described in Section 3.1 is conventionally done on a weight percentage basis. However, each geomembrane's processing is somewhat unique in its equipment and procedures. Even for a particular type of geomembrane, manufacturers will use different procedures, e.g., batch methods versus continuous feed systems, for blending or mixing.

Nevertheless, a few general considerations are important to follow in the preparation of a specification or MQA document.

1. The blending, compounding, mixing and/or masticating equipment must be clean and completely purged from previously mixed materials of a different formulation. This might require sending a complete cycle of purging material through the system, sometimes referred to as a "blank".
2. The various components of the formulation are added on a weight percentage basis to an accuracy set by industry standards. Different components are often added to the mixture at different locations in the processing, i.e., the entire batch is not necessarily added at the outset.
3. By the time the complete formulation is ready for extrusion or calendering it must be completely homogenized. No traces of segregation, agglomeration, streaking or discoloration should be visually apparent in the finished product.

3.2.2 Regrind, Reworked or Trim Reprocessed Material

"Regrind", "reworked" or "trim" are all terms which can be defined as finished geomembrane sheet material which has been cut from edges or ends of rolls, or is off-specification from a surface blemish, thickness or other property point of view. Figure 3.4(a) shows a photograph of HDPE regrind chips. VLDPE chips appear similar to HDPE. Figure 3.4(b) shows a photograph of PVC edge strips i.e., edge of sheet material cut off to meet specific roll width requirements. Excess edge trimmings of PVC sheet is fed back into the production system. CSPE-R trim can be added similarly, however without any reinforcing scrim.

These materials are reintroduced during the blending, compounding and/or mixing stage in controlled amounts as a matter of cost efficiency on the part of the manufacturer. Note that regrind, rework and trim material must be clearly distinguished from "recycled", or "reclaimed", material which is finished sheet material that has actually seen some type of service performance and has subsequently been returned to the manufacturing facility for reuse into new sheet material.

In preparing a specification or MQA document on the use of reprocessed material, the following items should be considered:

1. Regrind, reworked or trim materials in the form of chips or edge strips may be added if the material is from the same manufacturer and is exactly the same formulation as the geomembrane being produced.

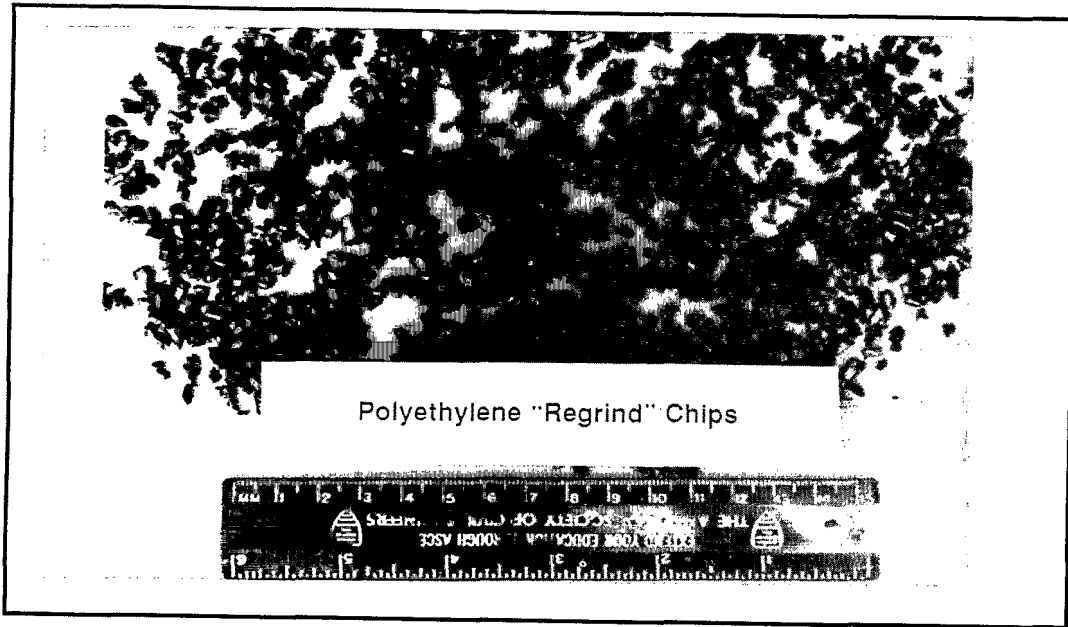

Figure 3.4(a) - HDPE Regrind Chips

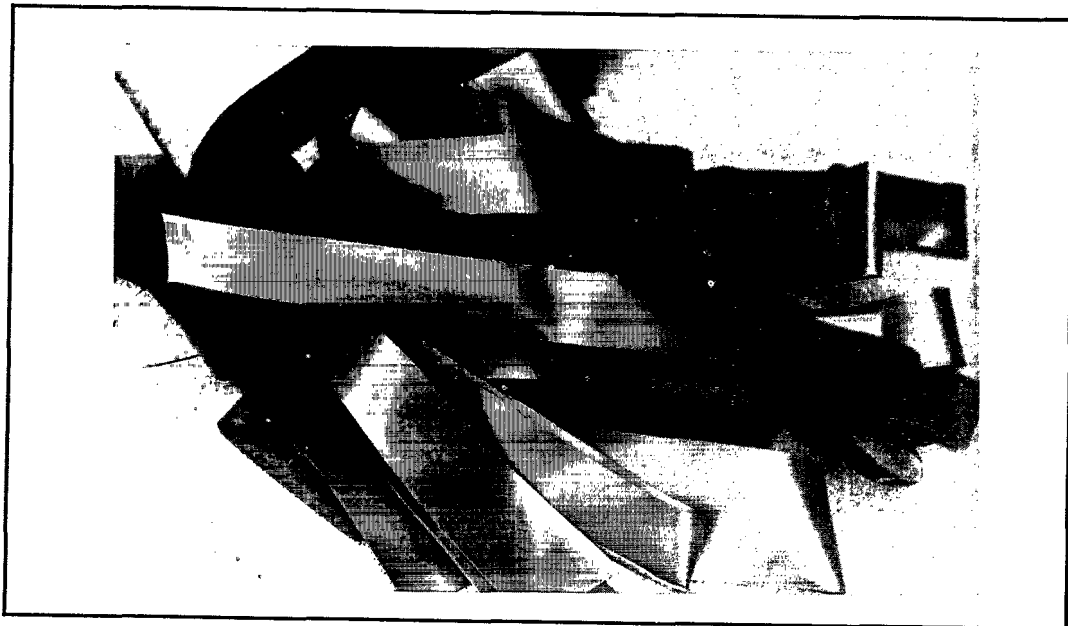

Figure 3.4(b) - PVC Edge Strips

Figure 3.4 - Photographs of Materials to be Reprocessed

2. Generally HDPE and VLDPE will be added in chip form as “regrind” in controlled amounts into the hopper of the extruder.
3. Generally PVC, CSPE and PP will be added in the form of a continuous strip of edge trimmings into the roll mill which precedes calendering. For scrim reinforced geomembranes it is important that the edge trim does not contain any portion of the fabric scrim.
4. The maximum amount of regrind, reworked or trim material to be added is a topic of considerable debate. Its occurrence in the completed sheet is extremely difficult, if not impossible, to identify much less to quantify by current chemical fingerprinting methods. Thus its maximum amount is not suggested in this manual. It should be mentioned that if regrind is not permitted to be used, the manufacturer may charge a premium over current practice.
5. It is generally accepted that no amount of “recycled”, or “reclaimed” sheet material (in any form whatsoever) should be added to the formulation.

3.2.3 High Density Polyethylene (HDPE)

High density polyethylene (HDPE) geomembranes are manufactured by taking the mixed components described earlier and feeding them into a hopper which leads to a horizontal extruder, see Fig. 3.5. In the manufacturing of HDPE geomembranes many extruders are 200 mm (8.0 inch) diameter systems which are quite large, e.g., up to 9 m (30 ft. long). In an extruder, the components enter a feed hopper and are transported via a continuous screw through a feed section, compression stage, metering stage, filtering screen and are then pressure fed into a die. The die options currently used for HDPE geomembrane production are either flat horizontal dies or circular vertical dies, the latter production technique often being referred to as “blown film” extrusion. The length of flat dies and the circumference of circular dies determine the width of the finished sheet and vary greatly from manufacturer to manufacturer. Some detail is given below.

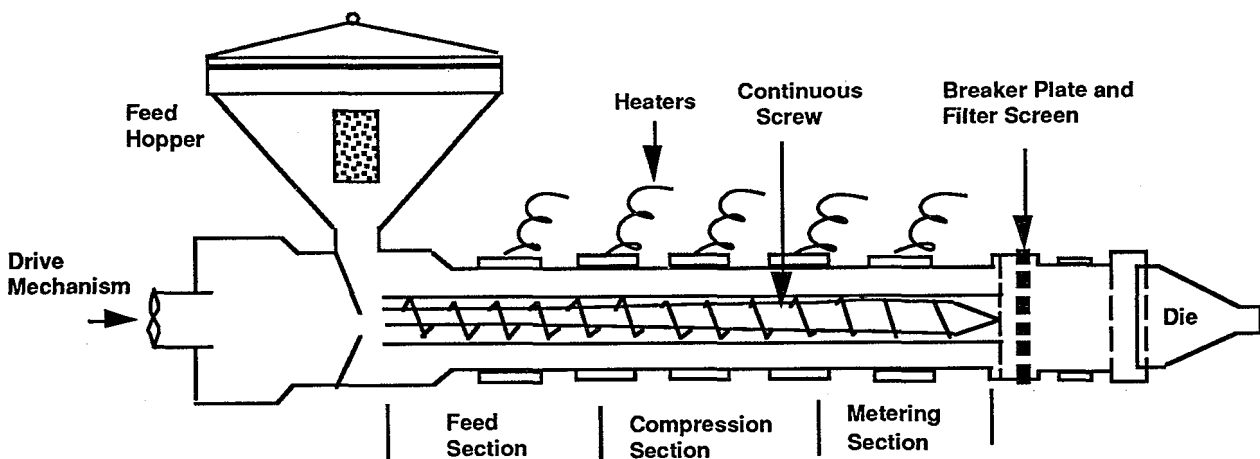

Figure 3.5 - Cross-Section Diagram of a Horizontal Single-Screw Extruder for Polyethylene

3.2.3.1 Flat Die - Wide Sheet

A conventional HDPE geomembrane sheet extruder can feed enough polymer to produce sheet up to approximately 4.5 m (15 ft.) wide in typical HDPE thicknesses of 0.75 to 3.0 mm (30 to 120 mils), see Fig. 3.6. Recently, one manufacturer has used two such extruders in parallel to produce sheet approximately 9.0 m (30 ft.) wide.

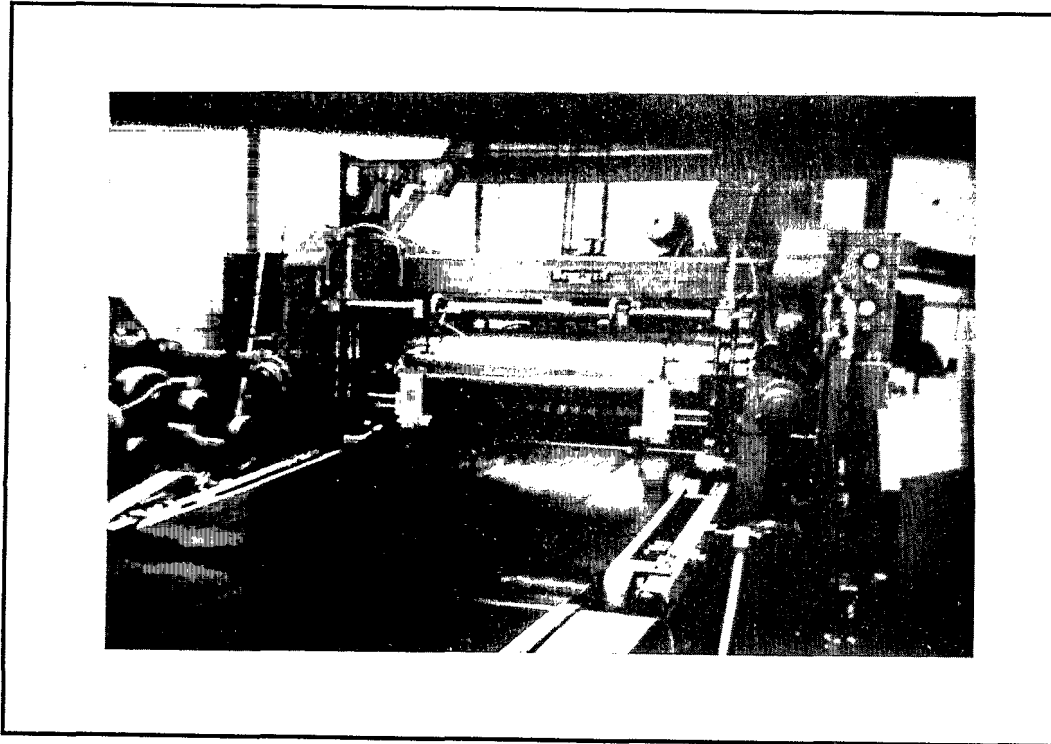

Figure 3.6 - Photograph of a Polyethylene Geomembrane Exiting from a Relatively Narrow Flat Horizontal Die

Insofar as a specification or MQA document for finished HDPE geomembranes made by flat die extrusion, the following items should be considered.

1. The finished geomembrane sheet must be free from pinholes, surface blemishes, scratches or other defects (e.g., nonuniform color, streaking, roughness, carbon black agglomerates, visually discernible regrind, etc.).
2. The nominal and minimum thicknesses of the sheet should be specified. The minimum value is usually related to the nominal thickness as a percentage. Values range from 5% to 10% less than nominal.

3. The maximum thickness of the sheet is rarely, if ever, specified. This is for the obvious reason that if a manufacturer wishes to supply sheet thicker than specified it is generally acceptable. It is also done, however, to allow for those manufacturers with unique variations of flat die extrusion (such as horizontal ribs or factory fabricated seams) to not be excluded from the market.
4. The finished sheet width should be controlled to be within a set tolerance. This is usually done by creating a sheet larger than called for, and trimming the edges immediately before final rolling onto the wind-up core. (The edge trim is subsequently ground into chips and used as regrind as previously described). Flat die extrusion of HDPE sheet should meet a $\pm 2.0\%$ width specification.
5. Other MQC tests such as strength, puncture, tear, etc. should be part of a certification program which should be available and implemented.
6. The frequency of performing each of the preceding tests should be covered in the MQC plan and it should be implemented and followed.
7. The trimmed and finished sheet is wound onto a hollow wind-up core which is usually heavy cardboard or (sometimes) plastic pipe. The outside diameter of the core should be at least 150 mm (6.0 in). It obviously must be stable enough to support the roll without buckling or otherwise failing during handling, storage and transportation.
8. Partial rolls for site specific project details may be cut and prepared for shipment per the contract drawings.

3.2.3.2 Flat Die - Factory Seamed

Since there are commercial extruders which produce sheets less than 6 m (20 ft) wide, the resulting sheet widths can be factory seamed into wider panels before shipment to the field. All of the specification details just described apply to narrow sheets as well as to wide sheets.

The method of factory seaming should be left to the discretion of the manufacturer. The factory seams, however, must meet the same specifications as the field seams (to be described later).

3.2.3.3 Blown Film

By using a vertically oriented circular die the extruder can feed molten polymer in an upward orientation creating a large cylinder of polyethylene sheet, see Fig. 3.7. Since the cylinder of polymer is closed at the top where it passes over a set of nip rollers which advances the cylinder, air is generally blown within it to maintain its dimensional stability. Note that upward moving air is also outside of the cylinder to further aid in stability. After passing through the nip rollers, the collapsed cylinder is cut longitudinally, opened to its full width, brought down to floor level and rolled onto a wind-up core. Note that collapsing the cylinder and passing it through the nip rollers results in two creases. After slitting the collapsed cylinder and opening it to full width, remnants of the two creases remain.

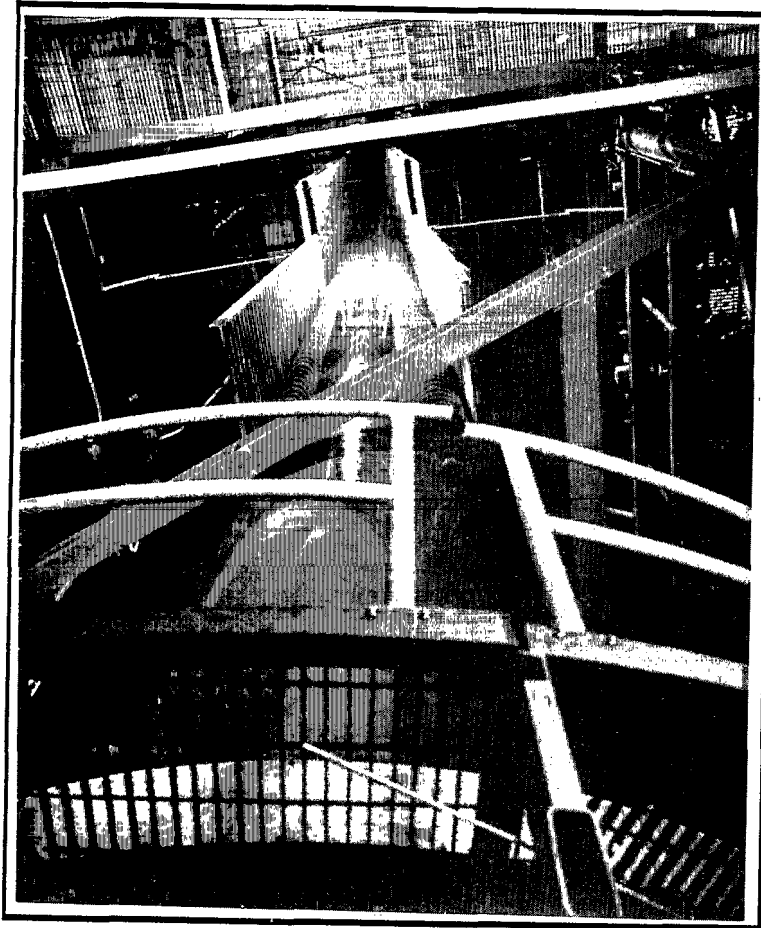

Figure 3.7 (a) - Photograph of Blown Film Manufacturing of Polyethylene Geomembranes

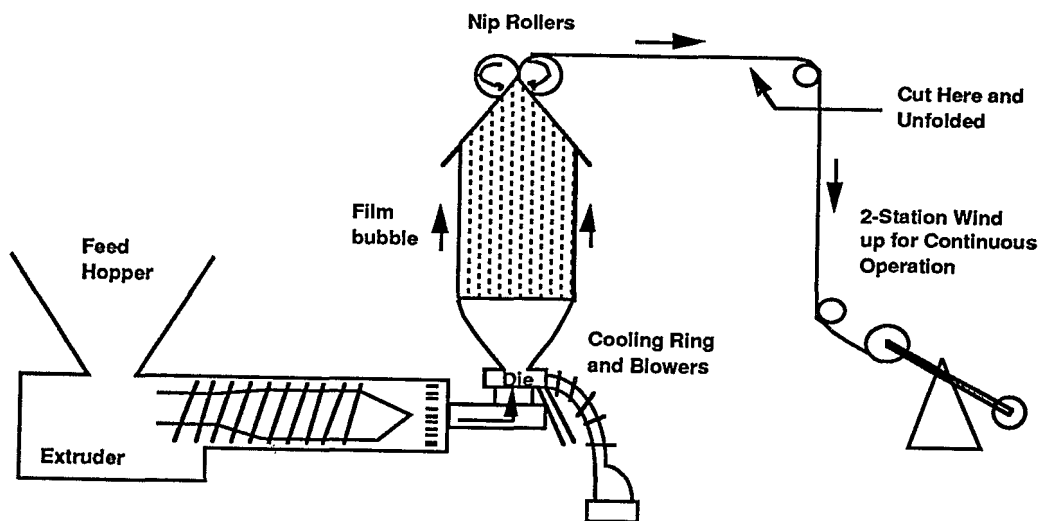

Fig. 3.7(b) - Sketch of Blown Film Manufacturing of Polyethylene Geomembranes

Regarding a specification or MQA document for blown film produced HDPE geomembranes, the following applies:

1. The finished geomembrane sheet shall be free from pinholes, surface blemishes, scratches or other defects (e.g., nonuniform color, streaking, roughness, carbon black agglomerates, visually discernible regrind, etc.). Note that two machine direction creases from nip rollers are automatically induced into the finished sheet at the 1/4 distances from each edge.
2. The nominal and minimum thickness of the sheet should be specified. The minimum value is usually related to the nominal thickness as a percentage. Values referenced range from 5% to 10% less than nominal.
3. The maximum thickness of the sheet is rarely, if ever, specified. This is for the obvious reason that if a manufacturer wishes to supply sheet thicker than specified it is generally acceptable.
4. The finished sheet width should be controlled to be within a set tolerance. HDPE geomembrane made from the blown film extrusion method should meet a $\pm 2.0\%$ width specification.
5. Other MQC tests such as tensile strength, puncture, tear, etc., should be part of a certification program which should be available and implemented.
6. The finished sheet is wound onto a hollow wind-up core which is usually heavy cardboard or sometimes plastic pipe. The outside diameter of the core should be at least 150 mm (6.0 in.). It must be stable enough to support the roll without buckling or otherwise failing during handling, storage and transportation.
7. It is important that the two creases located at the 1/4-points from the edges of the sheet are wound on the core such that they will face upward when deployed in the field. The reason for this is so that scratches will not occur on the creases if the sheets are shifted on the soil subgrade when in an open and flat position.
8. Partial rolls for site specific project details may be cut and prepared for shipment as per the contract drawings.

3.2.3.4 Textured Sheet

By creating a roughened surface on a smooth HDPE sheet, a process called “texturing” in this document, a high friction surface can be created. There are currently three methods used to texturize smooth HDPE geomembranes: coextrusion, impingement and lamination, see Fig. 3.8.

The *coextrusion* method utilizes a blowing agent in the molten extrudate and delivers it from a small extruder immediately adjacent to the main extruder. When both sides of the sheet are to be textured, two small extruders (one internal and one external to the main extruder) are necessary. As the extrudate from these smaller extruders meets the cool air the blowing agent expands, opens to the atmosphere and creates the textured surface(s).

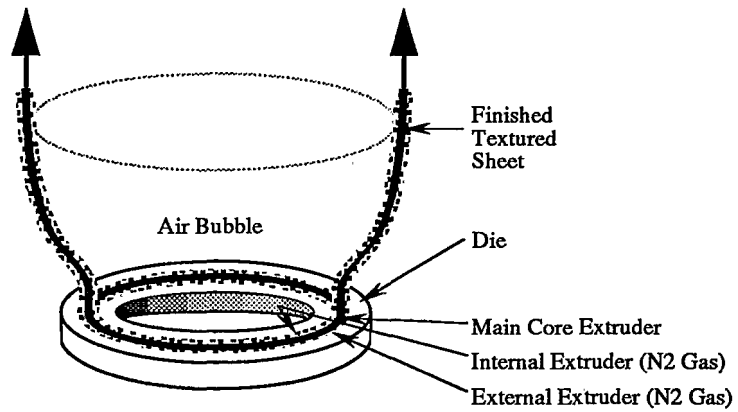

(a) Coextrusion with Nitrogen Gas

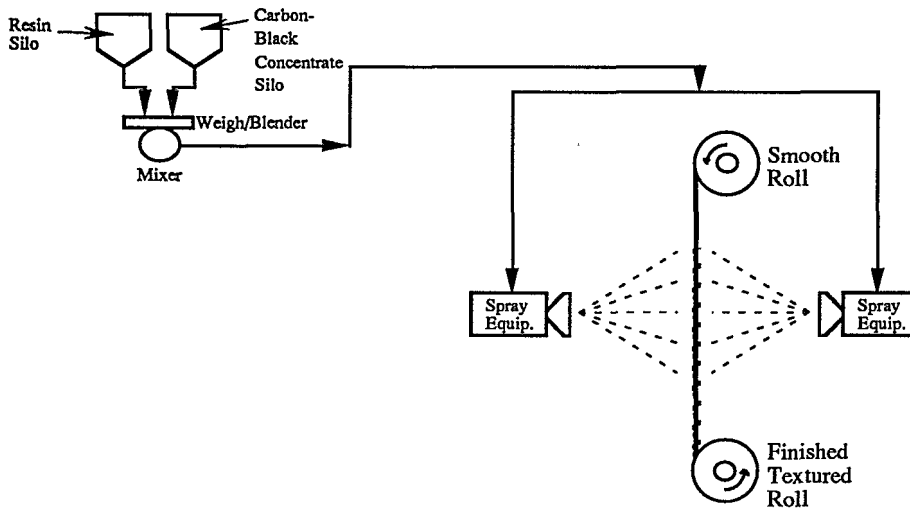

(b) Impingement of Hot Polyethylene Particles

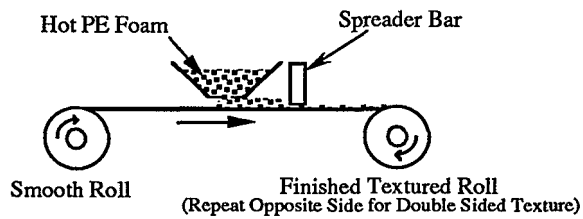

(c) Lamination with Polyethylene Foam

Figure 3.8 - Various Methods Currently Used to Create Textured Surfaces on HDPE Geomembranes

Impingement of hot HDPE particles against the finished HDPE sheet is a second method of texturing. In this case, hot particles are actually projected onto the previously prepared sheet on one or both of its surfaces in a secondary operation. The adhesion of the hot particles to the cold surface(s) should be as great, or greater, than the shear strength of the adjacent soil or other abutting material. The lengthwise edges of the sheets can be left non-textured for up to 300 mm (12 in.) so that thickness measurements and field seaming can be readily accomplished.

The third method for texturizing HDPE sheet is by *lamination* of an HDPE foam on the previously manufactured smooth sheet in a secondary operation. In this method a foaming agent contained within molten HDPE provides a froth which produces a rough textured laminate adhered to the previously prepared smooth sheet. The degree of adhesion is important with respect to the shear strength of the adjacent soil or other abutting material. If texturing on both sides of the geomembrane is necessary, the roll must go through another cycle but now on its opposite side. The lengthwise edges of the sheets can be left non-textured for up to 300 mm (12 in.) so that thickness measurements and field seaming can be readily accomplished.

Regarding the writing of a specification or MQA document on textured HDPE geomembranes the following points should be considered.

1. The surface texturing material should be of the same type of polymer and formulation as the base sheet polymer and its formulation. If other chemicals are added to the texturing material they must be identified in case of subsequent seaming difficulties.
2. The degree of texturing should be sufficient to develop the amount of friction as needed per the manufacturers specification and/or the project specifications.
3. The quality control of the texturing process can be assessed for uniformity using an inclined plane test method, e.g., GRI GS-7*.
4. The actual friction angle for design purposes should come from a large scale direct shear test simulating site specific conditions as closely as possible, e.g., ASTM D-5321.
5. The thickness of the base geomembrane should be micrometer measured (according to ASTM D-751) along the smooth edge strips of textured geomembranes made by impingement or lamination. For those textured geomembranes with no smooth edge strips, i.e., for blown film coextruded materials, an overall average thickness can be estimated on the basis of the roll weight divided by total area with suitable incorporation of the density of the material. Alternatively, a tapered point micrometer for measuring screw threads has also been used for point-to-point measurements.
6. Other MQC tests such as tensile strength, puncture, tear, etc., should be part of a certification program which should be available and implemented.
7. The frequency of performing each of the preceding tests should be covered in the MQC plan and it should be implemented and followed.

* The Geosynthetic Research Institute (GRI) provides interim test methods for a variety of geosynthetic related topics until such time as consensus organizations (like ASTM) adopt a standard on the same topic. At that time the GRI standard is abandoned.

3.2.4 Very Low Density Polyethylene (VLDPE)

Very low density polyethylene (VLDPE) geomembranes are manufactured by taking the mixed components described earlier and feeding them into a hopper which leads to a horizontal extruder, recall Fig. 3.5. In the extruder, the blended components enter via a feed hopper and are transported via a continuous screw, through a feed section, compression stage, metering stage, filtering screen and are then pressure fed into a die. The die options currently used for VLDPE geomembrane production are either flat horizontal dies or circular vertical dies, the latter often being referred to as “blown film” extrusion. The width of flat dies and the circumference of circular dies vary greatly from manufacturer to manufacturer. The techniques are the same as were described in the manufacture of HDPE geomembranes.

3.2.4.1 Flat Die - Wide Sheet

A conventional VLDPE sheet extruder can feed enough polymer to produce sheet up to approximately 4.5 m (15 ft.) wide in typical VLDPE thicknesses of 0.75 to 3.0 mm (30 to 120 mils), recall Fig. 3.6. In developing a specification or MQA document for the manufacture of VLDPE geomembranes the following should be considered:

1. The finished geomembrane sheet must be free from pinholes, surface blemishes, scratches or other defects (e.g, carbon black agglomerates, visually discernible regrind, etc.).
2. The minimum thickness of the sheet should be specified. It is usually related to the nominal thickness as a percentage. Values range from 5% to 10% less than nominal.
3. The maximum thickness of the sheet is rarely, if ever, specified. This is for the obvious reason that if a manufacturer wishes to supply sheet thicker than specified it is generally acceptable. It is also done, however, to allow for those manufacturers with unique variations of flat die extrusion (such as horizontal ribs or factory fabricated seams) to not be excluded from the market.
4. The finished sheet width should be controlled to be within a set tolerance. This is usually done by creating a sheet larger than called for, and trimming the edges immediately before final rolling onto the wind-up core. (The edge trim is subsequently ground into chips and used as regrind as previously described). Flat die extrusion of VLDPE sheet can readily meet a $\pm 0.25\%$ width specification.
5. Other MQC tests such as tensile strength, puncture, tear, etc. should be part of a certification program which should be available and implemented.
6. The trimmed and finished sheet is wound onto a hollow wind-up core which is usually heavy cardboard or sometimes plastic pipe. The outside diameter of the core should be at least 150 mm (6.0 in). It obviously must be stable enough to support the roll without buckling or otherwise failing.
7. Partial rolls for site specific project details may be cut and prepared for shipment as per contract drawings.

3.2.4.2 Flat Die - Factory Seamed

Since there are commercial extruders which produce significantly narrower sheet than just

discussed, the resulting narrow sheet widths can be factory seamed into wider panels before shipment to the field. All of the specification details just described apply to narrow sheets as well as to wide sheets.

The method of factory seaming should be left to the discretion of the manufacturer. The factory seams, however, must be held to the same destructive and nondestructive testing procedures as with field seams (to be described later).

3.2.4.3 Blown Film

By using a circular die oriented vertically the extruder can feed molten polymer in an upward orientation creating a large cylinder of polymer, recall Fig. 3.7. Since the cylinder is closed at the top where it passes over a set of nip rollers which advances the cylinder, air is generally contained within it maintaining its dimensional stability. Note that upward moving air is also outside of the cylinder to further aid in stability. After passing beyond the nip rollers the cylinder is cut longitudinally, opened to its full width, brought down to floor level and rolled onto a stable core.

The following items should be considered in preparing a specification or MQA document for blown film VLDPE geomembranes.

1. The finished geomembrane sheet shall be free from pinholes, surface blemishes, scratches or other defects (carbon black agglomerates, visually discernible regrind, etc.). Note that two machine direction creases from nip rollers are automatically induced into the finished sheet at the 1/4 distances from each edge.
2. The minimum thickness of the sheet should be specified. It is usually related to the nominal thickness as a percentage. Values referenced range from 5% to 10% less than nominal.
3. The maximum thickness of the sheet is rarely, if ever, specified. This is for the obvious reason that if a manufacturer wishes to supply sheet thicker than specified it is generally acceptable.
4. The finished sheet width should be controlled to be within a set tolerance. VLDPE geomembrane made from the blown film extrusion method should meet a $\pm 2.0\%$ width specification.
5. Other MQC tests such as tensile strength, puncture, tear, etc. should be part of a certification program which should be available and implemented.
6. The finished sheet is wound onto a hollow wind-up core which is usually heavy cardboard or sometimes plastic pipe. The outside diameter of the core should be at least 150 mm (6.0 in.). It obviously must be stable enough to support the roll without buckling or otherwise failing.
7. Partial rolls for site specific project details may be cut and prepared for shipment as per contract drawings.

3.2.4.4 Textured Sheet

By creating a roughened surface on a smooth VLDPE sheet, a process called "texturing" in

this document, a high friction surface can be created. There are currently three methods used to texturize smooth VLDPE geomembranes: coextrusion, impingement and lamination, recall Fig. 3.8.

The *coextrusion* method utilizes a blowing agent in the molten extrudate and delivers it from a small extruder immediately adjacent to the main extruder. When both sides of the sheet are to be textured, two small extruders, one internal and one external to the main extruder, are necessary. As the extrudate from these smaller extruders meets the cool air the blowing agent expands, opens to the atmosphere and creates the textured surface(s).

Impingement of hot polyethylene particles against the finished VLDPE sheet is a second method of texturing. In this case, hot particles are actually projected onto the previously prepared sheet on one or both of its surfaces in a secondary operation. The adhesion of the hot particles to the cold surface(s) should be as great, or greater, than the shear strength of the adjacent soil or other abutting material. The lengthwise edges of the sheets can be left non-textured for up to 30 cm (12 in.) so that thickness measurements and field seaming can be readily accomplished.

The third method for texturizing VLDPE sheet is by *lamination* of a hot polyethylene foam on the previously manufactured smooth sheet in a secondary operation. In this method a foaming agent contained in molten polyethylene provides a froth which produces a rough textured laminate adhered to the previously prepared smooth sheet. The degree of adhesion is important with respect to the shear strength of the adjacent soil or other abutting material. If texturing of both sides of the geomembrane is necessary the roll must go through another cycle but now on its opposite side. The lengthwise edges of the sheets can be left non-textured for up to 300 mm (12 in.) so that thickness measurements and field seaming can be readily accomplished.

Regarding the writing of a specification or MQA document on textured VLDPE geomembranes the following points should be considered.

1. The surface texturing material should be polyethylene of density equal to the VLDPE, or greater. The latter is often the case. If other chemicals are added to the texturing material they must be identified in case of subsequent seaming difficulties.
2. The degree of texturing should be sufficient to develop the amount of friction as needed per the manufacturers specification and/or the project specifications.
3. The quality control of the texturing process can be assessed for uniformity using an inclined plane test method, e.g., GRI GS-7.
4. The actual friction angle for design purposes should come from a large scale direct shear test simulating site specific conditions as closely as possible, e.g., ASTM D-5321.
5. The thickness of the base geomembrane should be micrometer measured (according to ASTM D-751) along the smooth edge strips of textured geomembranes made by impingement or lamination. For those textured VLDPE geomembranes with no smooth edge strips, i.e., for blown film coextruded materials, an overall average thickness can be estimated on the basis of the roll weight divided by total area with suitable incorporation of the density of the material. Alternatively, a tapered point micrometer for measuring screw threads has also been used for point-to-point measurements. Care must be exercised, however, because VLDPE thickness measurements with a point micrometer are very sensitive to pressure.

6. Other MQC tests such as tensile strength, puncture, tear, etc., should be part of a certification program which should be available and implemented.
7. The frequency of performing each of the preceding tests should be covered in the MQC plan and it should be implemented and followed.

3.2.5 Coextrusion Processes

As mentioned previously in Section 3.1.3, there are other variations of manufacturing polyethylene geomembranes. The basic manufacturing principle of adding the desired components to an extruder and having the molten polymer exit a flat horizontal die or a circular vertical die is always the same. What is different between these variations and the single component HDPE or VLDPE just described is the coextrusion process along with the idiosyncrasies of the particular materials utilized.

In coextrusion, two or three extruders simultaneously introduce molten polymer into the same die. As the different materials exit the die and are cooled they commingle with one another such that local blending and molecular entanglement occur and no discrete separation layer exists. Thus coextrusion is fundamentally different from the lamination of different surfaces together or of preformed sheets together under heat and pressure. Different variations of coextrusion of polyethylene geomembranes are described as follows.

Since polyethylene resin is supplied as a opaque pellet, the addition of colorants (rather than carbon black) can produce white, blue, green, etc., colored geomembranes. The benefit for geomembranes having these light colors is to reduce the surface temperature of the geomembrane when it is required to be exposed, e.g., as liners for surface impoundments or floating covers for reservoirs. Figure 3.9 shows how the temperature differences between white and black can be very significant. The white (or light) colors generally utilize titanium dioxide (or other metal oxides) in amounts not exceeding 1.0% by weight. Note that only a thin surface layer (approximately 10-20% of the total thickness) is treated in this manner. The balance of the geomembrane contains carbon black and is treated in the same manner as described previously.

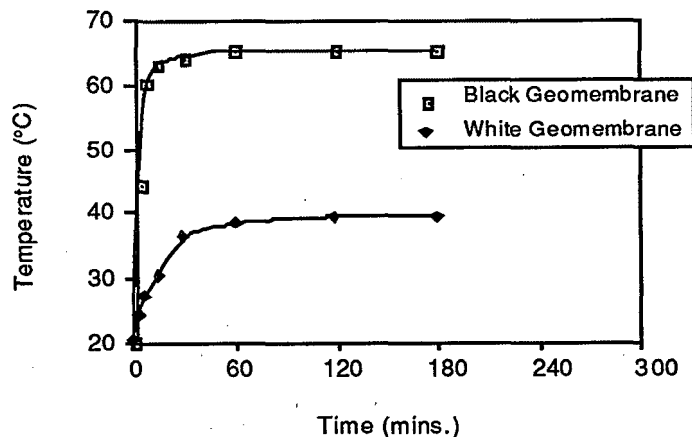

Figure 3.9 - Geomembrane Surface Temperature Differences Between Black and White Colors

A second variation of polyethylene is to coextrude a “sandwich” of HDPE on each side of VLDPE in the center. The purpose of such a combination is to provide high chemical resistance on the top and bottom of the sheet (via the HDPE) and to have high flexibility and out-of-plane

elongation properties within the core (via the VLDPE). The thickness percentages of these components are approximately 20%, 60% and 20% of the total thickness of the sheet, respectively.

Third, it is possible to coextrude a surface layer to conventional HDPE or VLDPE which contains a gas that expands when cooled. Thus the molten polymer moves through the die in a regular manner only to have the expanding gas rapidly exit on its surface(s). This forms a roughened, or textured, surface which depends on the amount of gas and thickness of the coextruded surface layer. Similar extruders can be used on both sides of the parent sheet. The purpose of such texturing is to increase the interface friction between the textured geomembrane and the material above and/or below it, refer to Sections 3.2.3.4 and 3.2.4.4.

Lastly, it is possible to coextrude other polymers than polyethylene. As noted in Section 3.1.3, fully crosslinked elastomeric alloys (FCEA) can be extruded or could be coextruded with other polymers.

3.2.6 Polyvinyl Chloride (PVC)

Polyvinyl chloride (PVC) geomembranes are manufactured by taking proportional weight amounts of PVC resin (a dry powder) and plasticizer (a liquid) and premixing them until the plasticizer is absorbed into the resin. Filler (in the form of a dry powder) and other additives (also usually dry powders) are then added to the plasticized resin and the total formulation is mixed in a blender. Various types of high intensity or low intensity blenders can be used. Note that PVC rework in the form of chips, rather than edge trim, can be introduced at this point.

The resulting free-flowing powder compound is fed into a mixer which has heat introduced thereby initiating a reaction between the various components. These mixers can be either batch type (e.g., Banbury) or continuous types (e.g., Farrel), see Figs. 3.10(a) and (b), respectively. In these mixers, the temperature is approximately 180°C (350°F) which melts the mixture into a viscous mass. The mixed material is then removed from the discharge door or port onto a conveyor belt. From the conveyor belt the viscous material is further worked (called "masticating") in a rolling mill (or mills) into a smooth, consistent, uniform color, continuous mass of 100-150 mm (4-6 in.) in diameter. Finished product edge trim can also be introduced into the rolling mill at this point. The fully mixed formulation is then fed by conveyor directly into the sizing calender.

3.2.6.1 Calendering

PVC formulations, irrespective of the pre-processing procedures, are manufactured into continuous geomembrane sheets by a calendering process. The viscous feed of polymer coming from the rolling mill(s) is worked and flattened between counter-rotating rollers into a geomembrane sheet. Most calenders are "inverted-L" configurations, see Fig. 3.11, but other options also exist. The rollers are usually smooth surfaced (they can be slightly textured) stainless steel cylinders and are up to 200 cm (80 in.) in width. The opening distance between adjacent cylinders is set for the desired thickness of the final sheet. A rolling bank of molten material is formed between adjacent rolls. In an inverted four roll "L" calender, 3 such banks are formed. They act as reservoirs for the molten material, and help to fill the sheet to full thickness as it passes between the rolls. As the geomembrane exits from the calender, it enters an additional series of rollers for the purposes of pickoff, embossing, stripping, cooling and cutting. At least one, and perhaps two, rollers in PVC manufacturing are embossed so as to impart a surface texture on the geomembrane. The purpose of this embossing is to prevent the rolled geomembrane from sticking together, i.e., "blocking", during wind-up, storage and transportation.

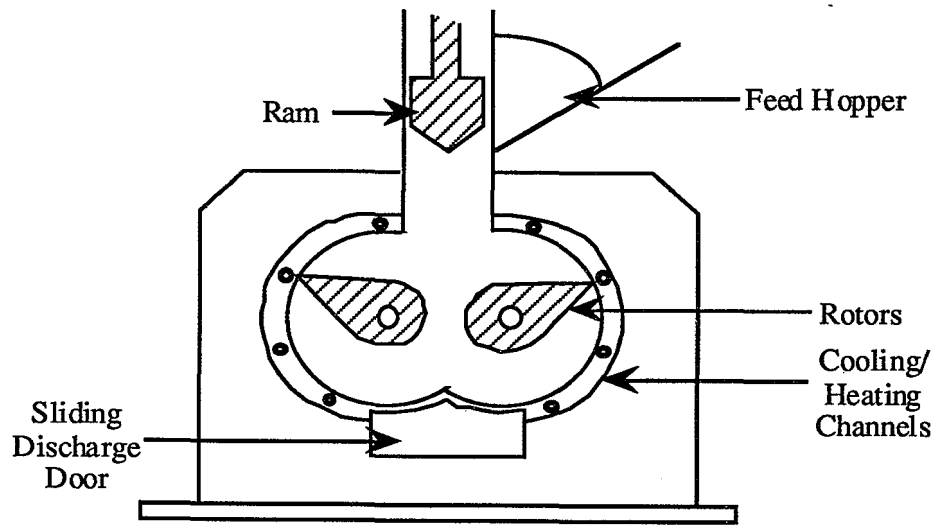

(a) Batch Process Mixer

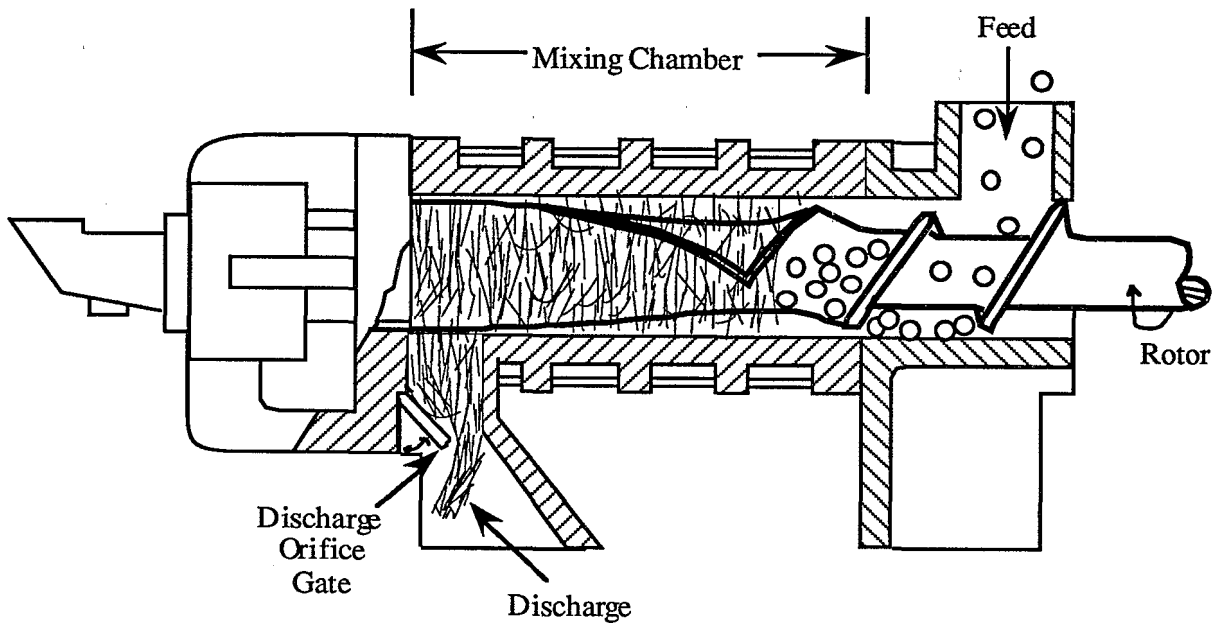

(b) Continuous Type Mixer

Figure 3.10 - Sketches of Various Process Mixers

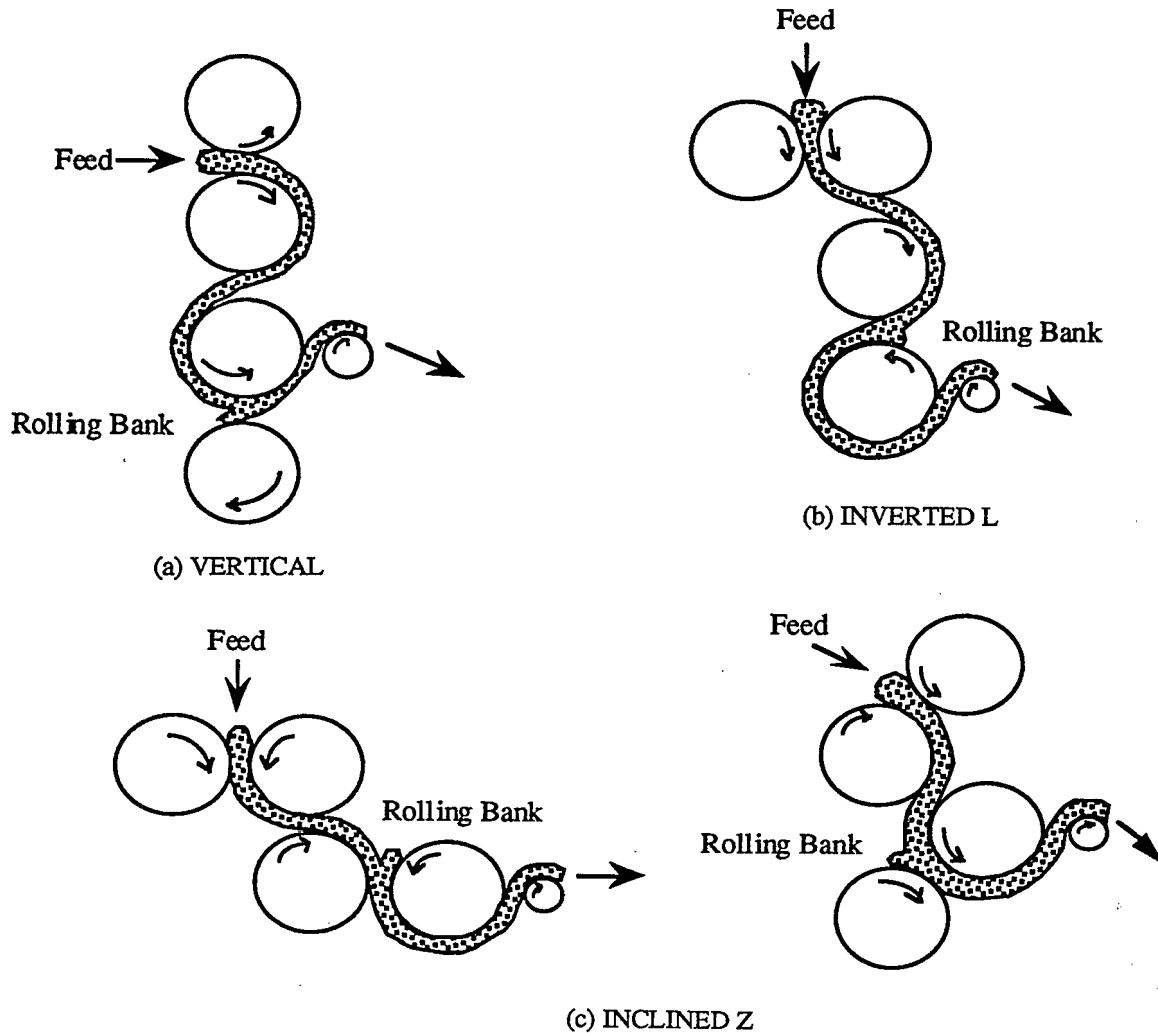

Figure 3.11 - Various Types of Four-Roll Calenders

In developing a specification or MQA document for the manufacturing of PVC geomembranes the following considerations are important:

1. The finished geomembrane sheet should be free from pinholes, surface blemishes, scratches or other defects (agglomerates of various additives or fillers, visually discernible rework, etc.)
2. The finished geomembrane sheet surfaces should be of a uniform color.
3. The addition of a dusting powder, such as talc, to eliminate blocking is not an acceptable practice. The powder will invariably attach to the sheet or be trapped within

the embossed irregularities and eventually be contained in the seamed area as a potential contaminant which could effect the adequacy of the seam.

4. The nominal and minimum thickness of the sheet should be specified. The minimum thickness of the finished geomembrane sheet is usually limited to the nominal thickness minus 5%.
5. The maximum thickness of the finished geomembrane sheet is generally not specified.
6. The width of the finished PVC geomembrane is dependent on the type of calender used by the manufacturer.
7. The geomembrane sheet should be edge trimmed to result in a specified width. This should be controlled to within $\pm 0.25\%$.
8. Various MQC tests such as tensile strength, puncture, tear, etc. should be part of a certification program which should be available and implemented.
9. The frequency of performing each of the preceding tests should be covered in the MQC plan and it should be implemented and followed.
10. The finished geomembrane sheet should be rolled onto stable wind-up cores of at least 75 mm (3.0 in.) in diameter.

3.2.6.2 Panel Fabrication

PVC geomembranes as just described are typically 100 to 200 cm (40 to 80 in.) wide and are transported in rolls weighing up to 6.7 kN (1500 pounds) to a panel fabrication facility, see Fig. 3.12 (upper photo). When a specific job order is placed, the rolls are unwound and placed directly on top of one another for factory seaming into a panel, see Fig. 3.12 (lower photo). A panel will typically consist of 5 to 10 rolls which are accordion seamed to one another, i.e., the left side of a particular roll is seamed to the underlying roll while the right side is seamed to the overlying roll. After seaming, the completed panel is again accordion folded (now in a lengthwise direction) and placed on a wooden pallet. It is then covered with a protective wrapper and shipped to the job site for deployment. To be noted is that some fabricators use other procedures for panel preparation.

Regarding a specification or MQA document for factory fabrication of PVC geomembrane panels, the following items should be considered.

1. The factory seaming of PVC rolls into panels should be performed by thermal or chemical seaming methods, see ASTM D-4545. It should be noted that dielectric seaming is a factory seaming method for joining PVC rolls. This is a thermal (or heat fusion) method that is acceptable and is unique to factory seaming of flexible thermoplastic geomembranes. It is currently not a field seaming method.
2. Factory seams should be subjected to the same type of destructive and nondestructive tests as field seams (to be described later).
3. When factory seams are made by chemical methods they are generally protected against blocking by covering them with a 100 mm (4 in.) wide strip of thin polyethylene film. When the panels are unfolded in the field these strips are discarded.

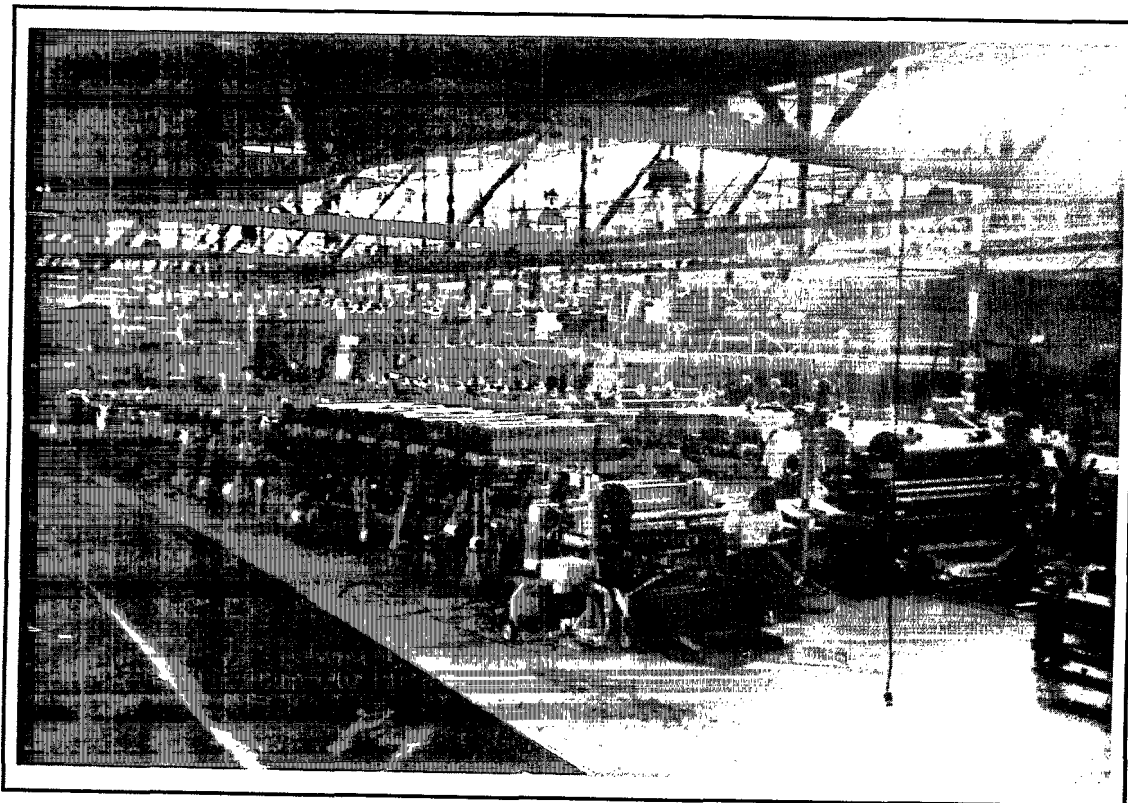
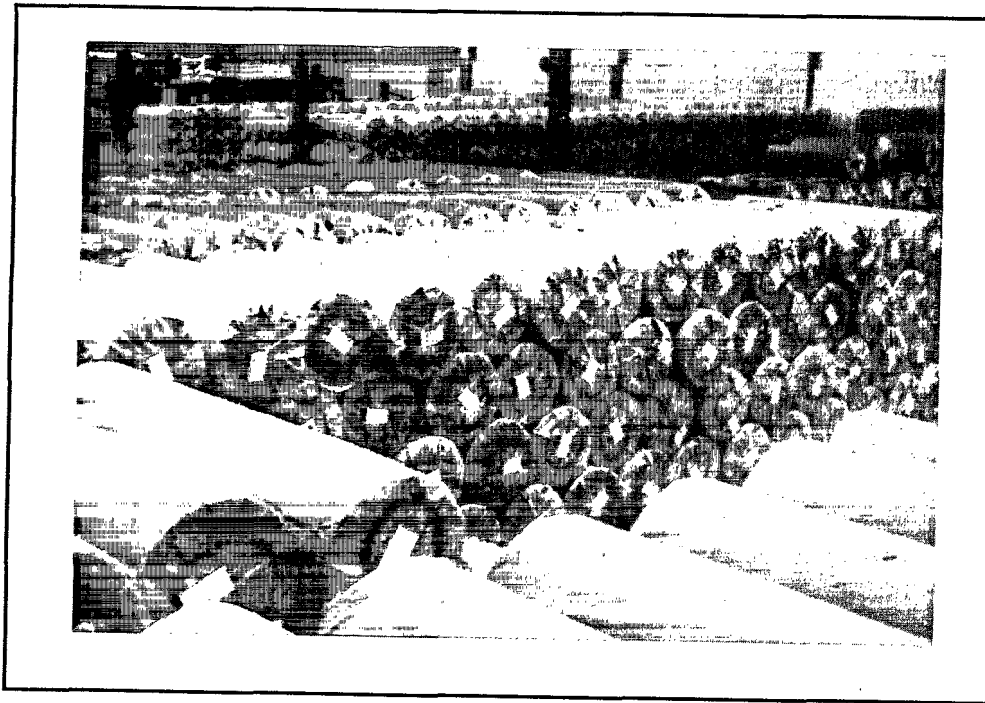

Figure 3.12 - Photographs of Calendered Rolls of Geomembranes After Manufacturing (Upper) and Factory Fabrication of Rolls into Large Panels for Field Deployment (Lower)

4. The finished and folded panels must be protected against accidental damage and excessive exposure during handling, transportation and storage. Usually they are protected by covering them in a heavy cardboard enclosure and placed on a wooden pallet for shipping.
5. The cardboard enclosures should be labeled and coded according to the specific job specifications.

3.2.7 Chlorosulfonated Polyethylene-Scrim Reinforced (CSPE-R)

Chlorosulfonated polyethylene geomembranes are made by mixing CSPE resin with carbon black (or their colorants) thereby making a "master batch" of these two components. Added to this master batch are fillers, additives and lubricants in a batch type mixer, e.g., a Banbury mixer, recall Fig. 3.10(a). Within the mixer the shearing action of the rotors against the ingredients generates enough heat to cause melting and subsequent chemical reactions to occur. After the mixing cycle is complete, the batch is dropped from the Banbury onto a two-roll mill, then to a conveyor leading to a second two-roll mill. In moving through the roll mill it is further mixed into a completely homogenized material having a uniform color and texture. It should be noted that edge trim is often taken from finished sheet and routed back to the roll mill for mixing and reuse.

A conveyor now transports the material directly to the calender, as shown in Fig. 3.11, and feeds it between the appropriate calender rolls.

3.2.7.1 Calendering

All CSPE formulations are manufactured into geomembrane sheets by a calendering process. Here the viscous ribbon of polymer is worked and flattened into a geomembrane sheet. Most calenders are "inverted-L" configurations, recall Fig. 3.11, but other options also exist. As the geomembrane exits the calender, it enters a series of rollers for the purposes of pickoff, stripping, cooling and cutting.

The inverted-L type calender provides an opportunity to introduce two simultaneous ribbons of the mixed and masticated polymeric compound thereby making two individual sheets of geomembranes. While this section of the manual is written around CSPE, it should be recognized that many other geomembrane types which are calendered can be made in multiple ply form as well. Since they are separately formed geomembrane sheets, they are brought together immediately upon exiting the calender to provide a laminated geomembrane consisting of two plys. Additional plys can also be added as desired, but this is not usually done in the manufacture of CSPE geomembranes.

While producing the two separate plys in an inverted-L calender as mentioned above, a woven fabric, called a reinforcing scrim, can be introduced between the two plys, see Fig. 3.13. The CSPE geomembrane is then said to be reinforced and is designed CSPE-R. It is common practice, however, to just use the acronym CSPE when referring to either the nonreinforced or reinforced variety of CSPE. The scrim is usually a woven polyester yarn with 6 x 6, 10 x 10 or 20 x 20 count. These numbers refer to the number of yarns per inch in the machine and cross machine directions, respectively. Other scrim counts are also possible.

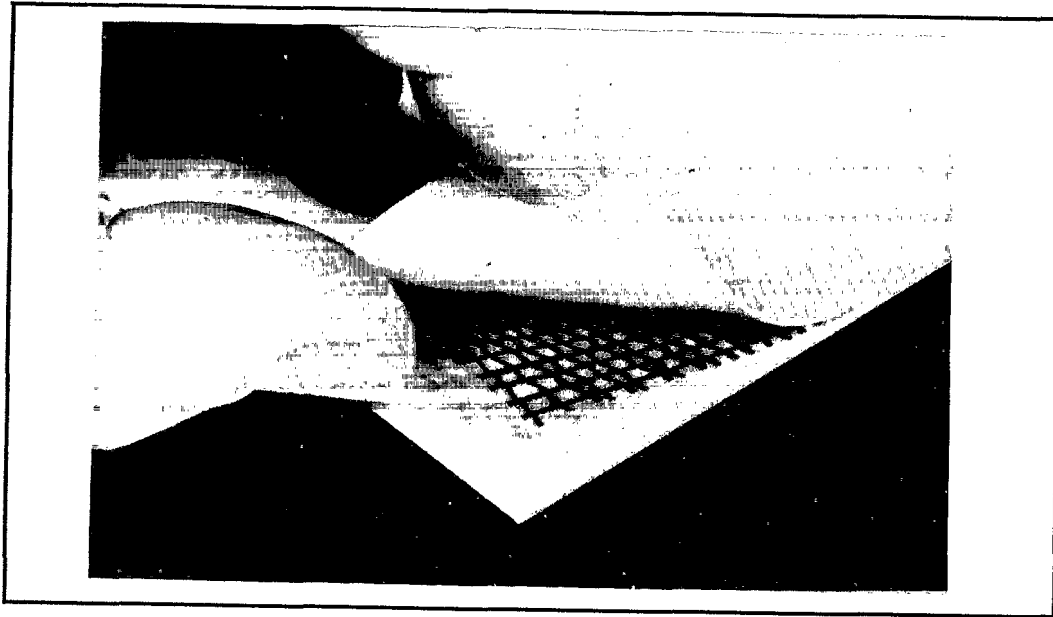

Figure 3.13 - Multiple-Ply Scrim Reinforced Geomembrane

Regarding the preparation of a specification or MQA document for multiple-ply scrim reinforced CSPE-R geomembranes the following should be considered.

1. The finished geomembrane should be free from surface blemishes, scratches and other defects (additive agglomerates, visually discernible rework, etc.).
2. The finished geomembrane sheet should be of a uniform color (which may be black, or by the addition of colorants, be white, tan, gray, blue, etc.), gloss and surface texture.
3. A uniform reinforcing scrim pattern should be reflected on both sides of the geomembrane and should be free from such anomalies as knots, gathering of yarns, delaminations or nonuniform and deformed scrim.
4. The sheet should not be embossed since the surface irregularities caused by the scrim are adequate to prohibit blocking.
5. The thickness of the sheet should be measured over the scrim and at a minimum should be the nominal thickness minus 10%.
6. The geomembrane sheet should have a salvage, i.e., geomembrane ply directly on geomembrane ply with no fabric scrim, on both edges. This salvage shall be approximately 6 mm (0.25 in.).
7. Various MQC tests such as strength, puncture, tear, ply adhesion, etc., should be part of a certification program which should be available and implemented.

8. The frequency of performing each of the preceding tests should be covered in the MQC plan and it should be implemented and followed.
9. The finished geomembrane sheet should be rolled onto stable wind-up cores of at least 75 mm (3.0 in.) in diameter.

3.2.7.2 Panel Fabrication

CSPE-R geomembranes as just described are typically 100 to 200 cm (40 to 80 in.) wide and are transported in rolls weighing up to 6.7 kN (1500 pounds) to a panel fabrication facility. When a specific job order is placed, the rolls are unwound and placed on top of one another for factory seaming into a panel, recall Fig. 3.12. A panel will typically consist of 5 to 10 rolls accordion seamed to one another. After seaming, the panel is accordion folded in its length direction and placed onto a wooden pallet. It is then appropriately covered and shipped to the job site for deployment. To be noted is that some fabricators use other procedures for panel preparation.

In preparing a specification or MQA document for CSPE-R geomembrane panels, the following items should be considered.

1. Factory seaming of CSPE-R rolls should use thermal, chemical or bodied chemical fusion methods, see ASTM D-4545. It should be noted that dielectric seaming is a factory seaming method for joining CSPE-R rolls. This is a thermal, or heat fusion, method that is acceptable and is currently unique to factory seaming of flexible thermoplastic geomembranes. It is not a field seaming method.
2. Factory seams should be subjected to the same type of nondestructive tests as field seams (to be described later). A start-up seam is made prior to making panel production seams from which destructive tests are taken (to be described later).
3. When factory seams are made by chemical fusion methods they are generally protected against sticking to the adjacent sheet (i.e., blocking) by covering them with 100 mm (4 in.) wide thin strip of polyethylene film. When the panels are unfolded in the field these strips are discarded. Other systems may not require this film.
4. The folded panels must be protected against accidental damage and excessive exposure during handling, transportation and storage. Usually they are protected by containing them in a heavy cardboard enclosure and placed on a wooden pallet for shipping.
5. The cardboard enclosures are labeled and coded according to the specific job specifications.

3.2.8 Spread Coated Geomembranes

As mentioned previously, an exception to the calendering method of producing flexible geomembranes, is the spread coating process. This process is currently unique to a geomembrane type called ethylene interpolymer alloy (EIA-R), but has been used to produce other specialty geomembranes in the past. The process utilizes a dense fabric substrate, commonly either a woven or nonwoven textile, and spreads the molten polymer on its surface. Due to the dense structure of the fabric, penetration of the viscous polymer to the opposite side is usually not complete. When

cooled, the sheet must be turned over and the process repeated on the opposite side. Adherence of the polymer to the fabric is essential.

Geomembranes produced by the spread coating method are indeed multiple-ply reinforced materials, but produced by a method other than calendaring. MQC and MQA plans and specifications should be framed in a similar manner as described previously for CSPE-R geomembranes.

3.3 Handling

While there should be great concern and care focused on the manufacturers and installers of geomembranes, it is also incumbent that they are packaged, handled, stored, transported, re-stored, re-handled and deployed in a manner so as not to cause any damage. This section is written with these many ancillary considerations in mind.

3.3.1 Packaging

Different types of geomembranes require different types of packaging after they are manufactured. Generally HDPE and VLDPE are packaged around a core in roll form, while PVC and CSPE-R are accordion folded in two directions and packaged onto pallets.

3.3.1.1 Rolls

Both HDPE and VLDPE geomembranes are manufactured and fed directly to a wind-up core in full-width rolls. No external wrapping or covering is generally needed, nor provided. These rolls, which weigh up to 22 kN (5000 pounds), are either moved by fork-lifts using a long rod inserted into the core (called a "stinger") or they are picked up by fabric slings with a crane or hoist. Note that the slings are often dedicated to each particular roll and follow along with it until its actual deployment. The rolls are usually stored in an outdoor area. They are stacked such that one roll is nested into the valley of the two underlying rolls, see Fig. 3.14.

Regarding a specification or MQA document for finished rolls of HDPE geomembranes the following applies.

1. The cores on which the rolls of geomembranes are wound should be at least 150 mm (6.0 in.) outside diameter.
2. The cores should have a sufficient inside diameter such that fork lift stingers can be used for lifting and movement.
3. The cores should be sufficiently strong that the roll can be lifted by a stinger or with slings without excessively deflecting, nor structurally buckling the roll.
4. The stacking of rolls at the manufacturing facility should not cause buckling of the cores nor flattening of the rolls. In general, the maximum stacking limit is 5 rolls high.
5. If storage at the manufacturer's facility is for longer than 6 months, the rolls should be covered by a sacrificial covering, or placed within a temporary or permanent enclosure.
6. The manufacturer should identify all rolls with the manufacturer's name, product identification, thickness, roller number, roll dimensions and date manufactured.

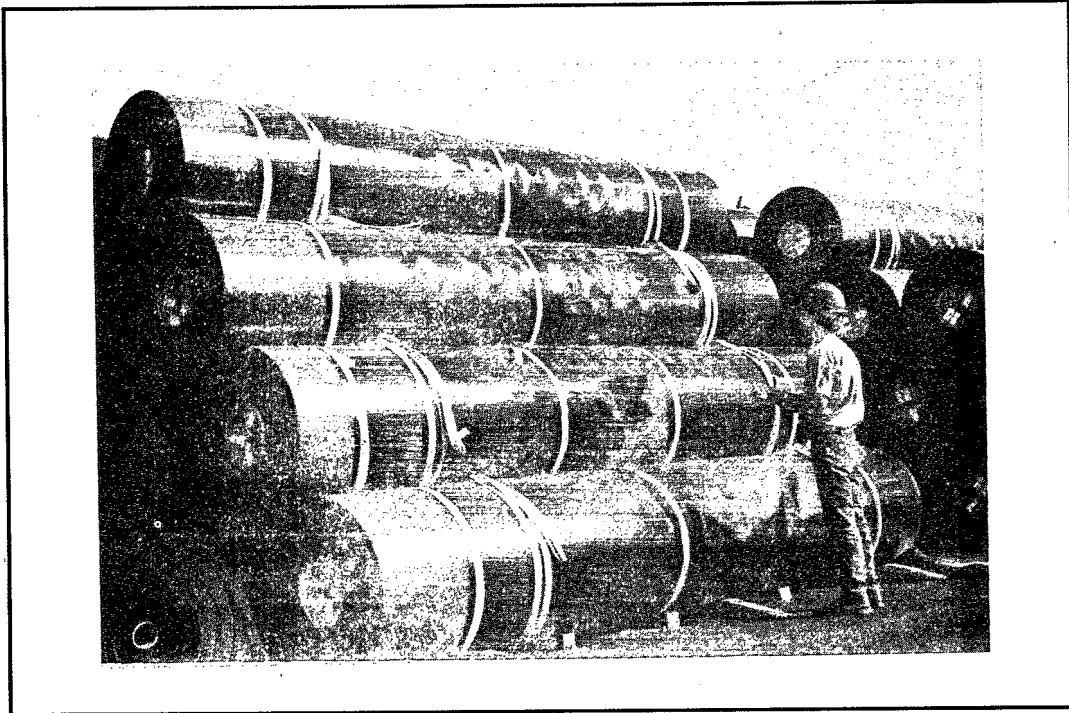

Figure 3.14 - Rolls of Polyethylene Awaiting Shipment to a Job Site

3.3.1.2 Accordion Folded

PVC and CSPE-R geomembranes are initially manufactured in rolls and are then sent to a fabricator for factory seaming into panels. At the fabrication facility they are unrolled directly on top of one another, factory seamed along alternate edges of the rolls and are then accordion folded both width-wise and length-wise and placed onto wooden pallets for packaging and shipment. PVC and CSPE-R geomembranes are generally not stored longer than a few weeks at the fabrication facility.

Regarding items for a specification or MQA document, the following applies.

1. The wooden pallets on which the accordion folded geomembranes are placed should be structurally sound and of good workmanship so that fork lifts or cranes can transport and maneuver them without structurally failing or causing damage to the geomembrane.
2. The wooden pallets should extend at least 75 mm (3 in.) beyond the edge of the folded geomembrane panel on all four sides.
3. The folded geomembrane panel should be packaged in treated cardboard or plastic wrapping for protection from precipitation and direct ultraviolet exposure.
4. Banding straps around the geomembrane and pallet should be properly cushioned so as not to cause damage to any part of the geomembrane panel.

5. Palletted geomembranes should be stored only on level surfaces since the folded material is susceptible to shifting and possible damage.
6. The stacking of palletted geomembrane panels on top of one another should not be permitted.
7. If storage at the fabricator's facility is for longer than 6 months, the palletted panels should be covered with a sacrificial covering, temporary shelter or placed within a permanent enclosure.
8. The fabricator should identify all panels with the manufacturers name, product information, thickness, panel number, panel dimensions and date manufactured.

3.3.2 Shipment, Handling and Site Storage

The geomembrane rolls or pallets are shipped to the job site, offloaded, and temporarily stored at a remote location on the job site, see Fig. 3.15.

Regarding items for a specification or CQA document* , the following applies:

1. Unloading of rolls or pallets at the job site's temporary storage location should be such that no damage to the geomembrane occurs.
2. Pushing, sliding or dragging of rolls or pallets of geomembranes should not be permitted.
3. Offloading at the job site should be performed with cranes or fork lifts in a workmanlike manner such that damage does not occur to any part of the geomembrane.
4. Temporary storage at the job site should be in an area where standing water cannot accumulate at any time.
5. The ground surface should be suitably prepared such that no stones or other rough objects which could damage the geomembranes are present.
6. Temporary storage of rolls of HDPE or VLDPE geomembranes in the field should not be so high that crushing of the core or flattening of the rolls occur. This limit is typically 5 rolls high.
7. Temporary storage of pallets of PVC or CSPE-R geomembranes by stacking should not be permitted.
8. Suitable means of securing the rolls or pallets should be used such that shifting, abrasion or other adverse movement does not occur.
9. If storage of rolls or pallets of geomembranes at the job site is longer than 6 months, a sacrificial covering or temporary shelter should be provided for protection against precipitation, ultraviolet exposure and accidental damage.

* Note that the designations of MQC and MQA will now shift to CQC and CQA since field construction personnel are involved. These designations will carry forward throughout the remainder of this Chapter.

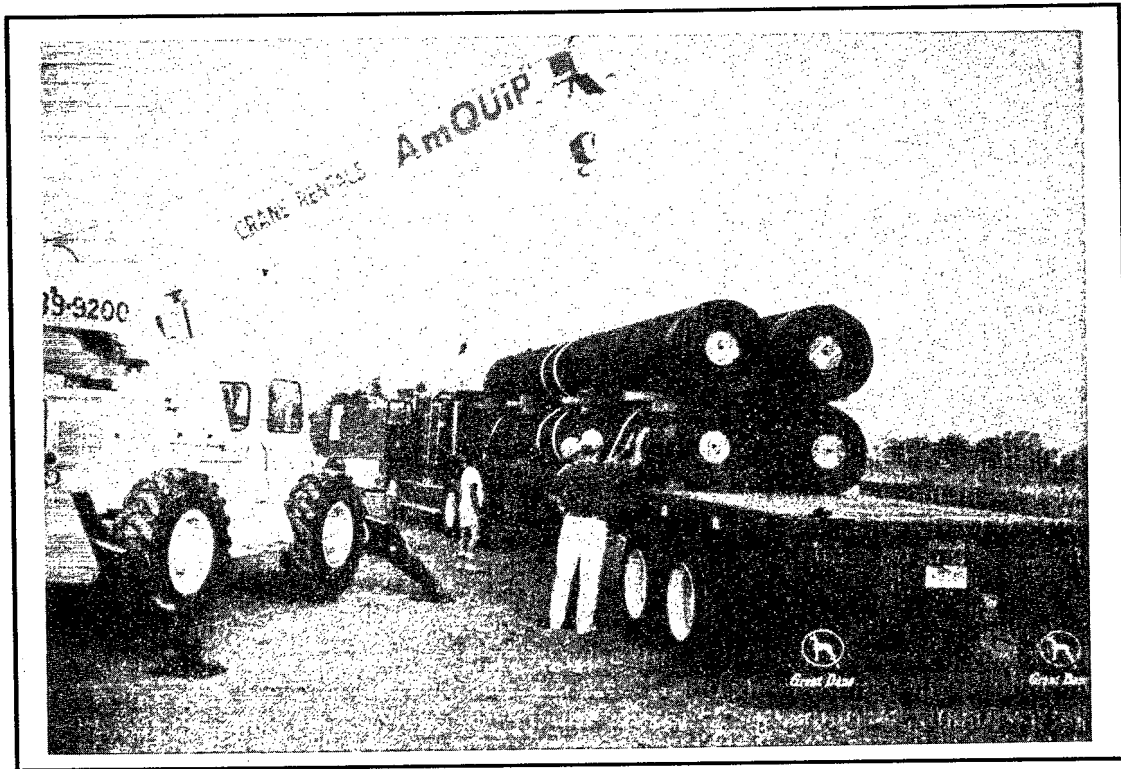

Figure 3.15 - Photograph of Truck Shipment of Geomembranes

3.3.3 Acceptance and Conformance Testing

It is the primary duty of the installation contractor, via the CQC personnel, to see that the geomembrane supplied to the job site is the proper material that was called for in the contract, as specified by the Plans and Specifications. It is also the duty of the CQA Engineer to verify this material to be appropriate. Clear marking should identify all rolls or pallets with the information described in Section 3.3.1. A complete list of roll numbers should be prepared for each material type.

Upon delivery of the rolls or pallets of geomembrane, the CQA Engineer should ensure that conformance test samples are obtained and sent to the proper laboratory for testing. This will generally be the laboratory of the CQA firm, but may be that of the CQC firm if so designated in the CQA documents. Alternatively, conformance testing could be performed at the manufacturers facility and when completed the particular lot should be marked for the particular site under investigation.

The following items should be considered for a specification or CQA document with regard to acceptance and conformance testing.

1. The particular tests selected for acceptance and conformance testing can be all of those listed previously, but this is rarely the case since MQC and MQA testing should have preceded the field operations. However, at a minimum, the following tests are recommended for field acceptance and conformance testing for the particular

geomembrane type.

- (a) HDPE: thickness (ASTM D-5199), tensile strength and elongation (ASTM D-638) and possibly puncture (FTM Std 101C) and tear resistance (ASTM D-1004, Die C)
 - (b) VLDPE: thickness (ASTM D-5199), tensile strength and elongation (ASTM D-638), and possibly puncture (FTM Std 101C) and tear resistance (ASTM D-1004, Die C)
 - (c) PVC: thickness (ASTM D-5199), tensile strength and elongation (ASTM D-882), tear resistance (ASTM D-1004, Die C)
 - (d) CSPE-R: thickness (ASTM D-5199), tensile strength and elongation (ASTM D-751), ply adhesion (ASTM D-413, Machine Method, Type A)
2. The method of geomembrane sampling should be prescribed. For geomembranes on rolls, 1 m (3 ft.) from the entire width of the roll on the outermost wrap is usually cut and removed. For geomembranes folded on pallets, the protective covering must be removed, the uppermost accordion folded section opened and an appropriate size sample taken. Alternatively, factory seam retains can be shipped on top of fabricated panels for easy access and use in conformance testing.
 3. The machine direction must be indicated with an arrow on all samples using a permanent marker.
 4. Samples are usually taken on the basis of a stipulated area of geomembrane, e.g., one sample per 10,000 m² (100,000 ft²). Alternatively, one could take samples at the rate of one per lot, however, a lot must be clearly defined. One possible definition could be that a lot is a group of consecutively numbered rolls or panels from the same manufacturing line.
 5. All conformance test results should be reviewed, accepted and reported by the CQA Engineer before deployment of the geomembrane.
 6. Any nonconformance of test results should be reported to the Owner/Operator. The method of a resolution of such differences should be clearly stated in the CQA document. One possible guidance document for failing conformance tests could be ASTM D-4759 titled "Determining the Specification Conformance of Geosynthetics".

3.3.4 Placement

When the subgrade or subbase (either soil or some other geosynthetic) is approved as being acceptable, the rolls or pallets of the temporarily stored geomembranes are brought to their intended location, unrolled or unfolded, and accurately spotted for field seaming, see Fig. 3.16.

3.3.4.1 Subgrade (Subbase) Conditions

Before beginning to move the geomembrane rolls or pallets from their temporary storage location at the job site, the soil subgrade (or other subbase material) should be checked for its preparedness.

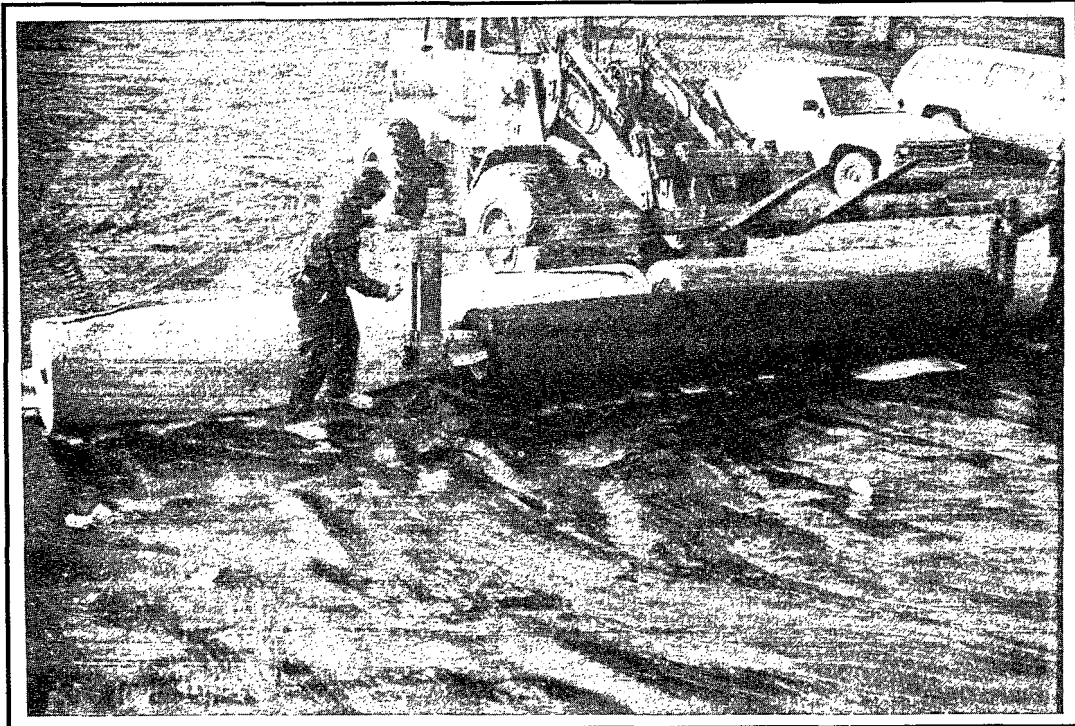

Figure 3.16 - Photographs Showing the Unrolling (Upper) and Unfolding (Lower) of Geomembranes

Some items recommended for a specification or CQA document include the following:

1. The soil subgrade shall be of the specified grading, moisture content and density as required by the installer and as approved by the CQA engineer for placement of the geomembrane. See Chapter 2 for these details for compacted clay liner subgrades.
2. Construction equipment deploying the rolls or pallets shall not deform or rut the soil subgrade excessively. Tire or track deformations beneath the geomembrane should not be greater than 25 mm (1.0 in.) in depth.
3. The geomembrane shall not be deployed on frozen subgrade where ruts are greater than 12 mm (0.5 in.) in depth.
4. When placing the geomembrane on another geosynthetic material (geotextile, geonet, etc.), construction equipment should not be permitted to ride directly on the lower geosynthetic material. In cases where rolls must be moved over previously placed geosynthetics it is necessary to move materials by hand or by using small pneumatic tired lifting units. Tire inflation pressures should be limited to a maximum value of 40 kPa (6 lb/in²).
5. Underlying geosynthetic materials (such as geotextiles or geonets) should have all folds, wrinkles and other undulations removed before placement of the geomembrane.
6. Care, and planning, should be taken to unroll or unfold the geomembrane close to its intended, and final, position.

3.3.4.2 Temperature Effects - Sticking/Cracking

High temperatures can cause geomembrane surfaces on rolls, or accordion folded on pallets, to stick together, a process commonly called "blocking". At the other extreme, low temperatures can cause geomembrane sheets to crack when unrolled or unfolded. Comments on unrolling, or unfolding of geomembranes at each of these temperature extremes follow.

For example, a specification or CQA document should have included in it the following items.

1. Geomembranes when unrolled or unfolded should not stick together to the extent where tearing, or visually observed straining of the geomembrane, occurs. The upper temperature limit is very specific to the particular type of geomembrane. A sheet temperature of 50°C (122°F) is the upper limit that a geomembrane should be unrolled or unfolded unless it is shown otherwise to the satisfaction of the CQA engineer.
2. Geomembranes which have torn or have been excessively deformed should be rejected, or shall be repaired per the CQA Document.
3. Geomembranes when unrolled or unfolded in cold weather should not crack, craze, or distort in texture. A sheet temperature of 0°C (32°F) is the lower limit that a geomembrane should be unrolled or unfolded unless it is shown otherwise to the satisfaction of the CQA engineer.

3.3.4.3 Temperature Effects - Expansion/Contraction

Polyethylene geomembranes expand when they are heated and contract when they are cooled. Other types of geomembranes may slightly contract when heated. This expansion and contraction must be considered when placing, seaming and backfilling geomembranes in the field. Fig. 3.17 shows a wrinkled polyethylene liner which has expanded due to thermal warming from the sun.

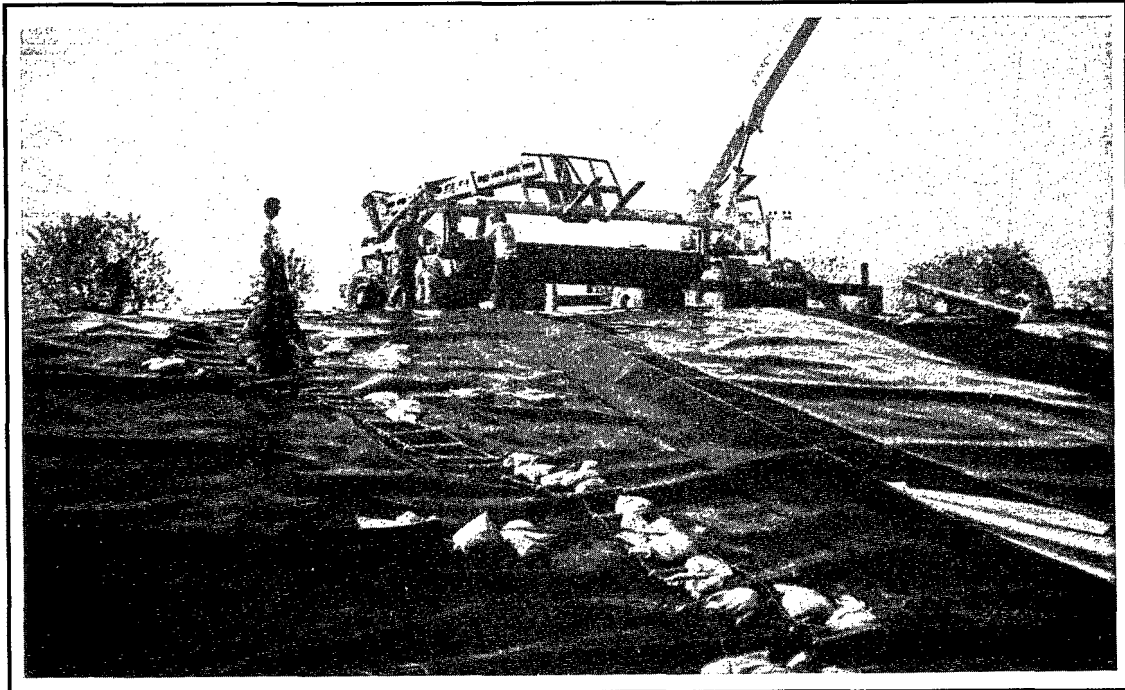

Figure 3.17 - HDPE Geomembrane Showing Sun Induced Wrinkles

Either the contract plans and specifications, or the CQA documents should cover the expansion/contraction situation on the basis of site specific and geomembrane specific conditions. Some items to consider include the following:

1. Sufficient slack shall be placed in the geomembrane to compensate for the coldest temperatures envisioned so that no tensile stresses are generated in the geomembrane or in its seams either during installation or subsequently after the geomembrane is covered.
2. The geomembrane shall have adequate slack such that it does not lift up off of the subgrade or substrate material at any location within the facility, i.e., no “trampolining” of the geomembrane shall be allowed to occur at any time.

3. The geomembrane shall not have excessive slack to the point where creases fold over upon themselves either during placement and seaming, or when the protective soil or drainage materials are placed on the geomembrane.
4. Permanent (fold-over type) creases in the covered geomembrane should not be permitted at any time.
5. The amount of slack to be added to the deployed and seamed geomembrane should be carefully considered and calculated, taking into account the type of geomembrane and the geomembrane's temperature during installation versus its final temperature in the completed facility.

3.3.4.4 Spotting

When a geomembrane roll or panel is deployed it is generally required that some shifting will be necessary before field seaming begins. This is called "spotting" by many installers.

Some items for a specification or CQA document should include the following:

1. Spotting of deployed geomembranes should be done with no disturbance to the soil subgrade or geosynthetic materials upon which they are placed.
2. Spotting should be done with a minimum amount of dragging of the geomembrane on soil subgrades.
3. Temporary tack welding (usually with a hand held hot air gun) of all types of thermoplastic geomembranes should be allowed at the installers discretion.
4. When temporary tack welds of geomembranes are utilized, the welds should not interfere with the primary seaming method, or with the ability to perform subsequent destructive seam tests.

3.3.4.5 Wind Considerations

Wind damage to geomembranes, unfortunately, is not an uncommon occurrence, see Fig. 3.18. Many deployed geomembranes have been uplifted by wind and have been damaged. In some cases the geomembranes have even been torn out of anchor trenches. This is sometimes referred to as "blow-out" by field personnel. Generally, but not always, the unseamed geomembrane rolls or panels acting individually are most vulnerable to wind uplift and damage.

The contract plans and specification, or at least the CQA documents, must be very specific as to resolutions regarding geomembranes that have been damaged due to shifting by wind. Some suggestions follow.

1. Geomembrane rolls or panels which have been displaced by wind should be inspected and approved by the CQA engineer before any further field operations commence.
2. Geomembrane rolls or panels which have been damaged (torn, punctured, or deformed excessively and permanently) shall be rejected and/or repaired as directed in the contract plans, specifications or CQA documents.
3. Permanent crease marks, or severely folded (crimped) locations, in geomembranes

should not be permitted unless it can be shown that such distortions have no adverse effect on the properties of the geomembrane. If this cannot be done, these areas should be cut out and properly patched as per the contract documents and approved by the CQA Engineer.

4. If patching of wind damaged geomembranes becomes excessive (to the limit set forth in the specifications or CQA plan), the entire roll or panel should be rejected.

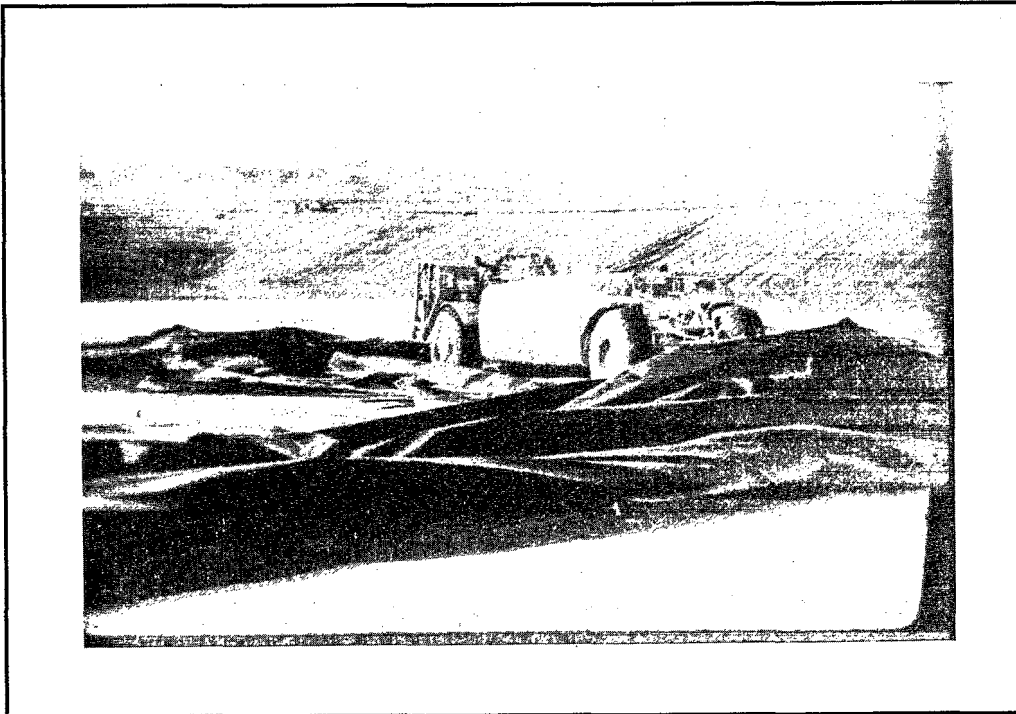

Figure 3.18 - Wind Damage to Deployed Geomembrane

3.4 Seaming and Joining

The field seaming of the deployed geomembrane rolls or panels is a critical aspect of their successful functioning as a barrier to liquid (and sometimes vapor) flow. This section describes the various seaming methods in current use, references a recently published EPA Technical Guidance Document on seam fabrication techniques (EPA, 1991), and describes the concept and importance of test strips (or trial seams).

3.4.1 Overview of Field Seaming Methods

The fundamental mechanism of seaming polymeric geomembrane sheets together is to temporarily reorganize, i.e., melt, the polymer structure of the two surfaces to be joined in a

controlled manner that, after the application of pressure and after the passage of a certain amount of time, results in the two sheets being bonded together. This reorganization results from an input of energy that originates from either thermal or chemical processes. These processes may involve the addition of extra polymer in the bonded area.

Ideally, seaming two geomembrane sheets would result in no net loss of tensile strength across the two sheets and the joined sheets would perform as one single geomembrane sheet. However, due to stress concentrations resulting from the seam geometry, current seaming techniques may result in minor tensile strength loss relative to the parent geomembrane sheet. The characteristics of the seamed area are a function of the type of geomembrane and the seaming technique used. These characteristics, such as residual strength, geomembrane type, and seaming type, should be recognized by the designer when applying the appropriate design factors-of-safety for the overall geomembrane function and facility performance.

It should be noted that the seam can be the location of the lowest tensile strength in a geomembrane liner. Designers and inspectors should be aware of the importance of seeking only the highest quality geomembrane seams. The minimum seam tensile strengths (as determined by design) for various geomembranes must be predetermined by laboratory testing, knowledge of past field performance, manufacturers literature, various trade journals or other standards setting organizations that maintain current information on seaming techniques and technologies.

The methods of seaming at the time of the printing of this document and discussed herein are given in Table 3.2 and shown schematically in Fig. 3.19.

Table 3.2. Fundamental Methods Of Joining Polymeric Geomembranes

| Thermal Processes | Chemical Processes |
|---|--|
| <u>Extrusion:</u> <ul style="list-style-type: none"> • Fillet • Flat | <u>Chemical:</u> <ul style="list-style-type: none"> • Chemical Fusion • Bodied Chemical Fusion |
| <u>Fusion:</u> <ul style="list-style-type: none"> • Hot Wedge • Hot Air | <u>Adhesive:</u> <ul style="list-style-type: none"> • Chemical Adhesive • Contact Adhesive |

Within the entire group of thermoplastic geomembranes that will be discussed in this manual, there are four general categories of seaming methods extrusion welding, thermal fusion or melt bonding, chemical fusion and adhesive seaming. Each will be explained along with their specific variations so as to give an overview of field seaming technology.



Fillet - Type



Flat - Type

(a) Extrusion Seams



Dual Hot Wedge
(Single Track is Also Possible)



Single Hot Air
(Dual Track is Also Possible)

(b) Fusion Seams

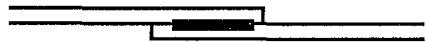

Chemical



Bodied Chemical

(c) Chemical Seams

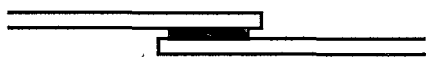

Chemical Adhesive

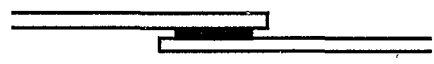

Contact Adhesive

(d) Adhesive Seams

Figure 3.19 - Various Methods Available to Fabricate Geomembrane Seams

Extrusion welding is presently used exclusively on geomembranes made from polyethylene. A ribbon of molten polymer is extruded over the edge of, or in between, the two surfaces to be joined. The molten extrudate causes the surfaces of the sheets to become hot and melt, after which the entire mass cools and bonds together. The technique is called extrusion fillet seaming when the extrudate is placed over the leading edge of the seam, and is called extrusion flat seaming when the extrudate is placed between the two sheets to be joined. It should be noted that extrusion fillet seaming is essentially the only practical method for seaming polyethylene geomembrane patches, for seaming in poorly accessible areas such as sump bottoms and around pipes and for seaming of extremely short seam lengths. Temperature and seaming rate both play important roles in obtaining an acceptable bond; excessive melting weakens the geomembrane and inadequate melting results in poor extrudate flow across the seam interface and low seam strength. The polymer used for the extrudate is also very important and should generally be the same polyethylene compound used to make the geomembrane. The designer should specify acceptable extrusion compounds and how to evaluate them in the specifications and CQA documents.

There are two thermal fusion or melt-bonding methods that can be used on all thermoplastic geomembranes. In both of them, portions of the opposing surfaces are truly melted. This being the case, temperature, pressure, and seaming rate all play important roles in that excessive melting weakens the geomembrane and inadequate melting results in low seam strength. The hot wedge, or hot shoe, method consists of an electrically heated resistance element in the shape of a wedge that travels between the two sheets to be seamed. As it melts the surface of the two sheets being seamed, a shear flow occurs across the upper and lower surfaces of the wedge. Roller pressure is applied as the two sheets converge at the tip of the wedge to form the final seam. Hot wedge units are controllable as far as temperature, amount of pressure applied and travel rate. A standard hot wedge creates a single uniform width seam, while a dual hot wedge (or "split" wedge) forms two parallel seams with a uniform unbonded space between them. This space can be used to evaluate seam quality and continuity of the seam by pressurizing the unbonded space with air and monitoring any drop in pressure that may signify a leak in the seam.

The hot air method makes use of a device consisting of a resistance heater, a blower, and temperature controls to force hot air between two sheets to melt the opposing surfaces. Immediately following the melting of the surfaces, pressure is applied to the seamed area to bond the two sheets. As with the hot wedge method, both single and dual seams can be produced. In selected situations, this technique may also be used to temporarily "tack" weld two sheets together until the final seam or weld is made and accepted.

Regarding the chemical fusion seam types; chemical fusion seams make use of a liquid chemical applied between the two geomembrane sheets to be joined. After a few seconds, required to soften the surface, pressure is applied to make complete contact and bond the sheets together. As with any of the chemical seaming processes to be described, the two adjacent materials to be bonded are transformed into a viscous phase. Care must be used to see that the proper amount of chemical is applied in order to achieve the desired results. Bodied chemical fusion seams are similar to chemical fusion seams except that 1% to 20% of the parent lining resin or compound is dissolved in the chemical and then is used to make the seam. The purpose of adding the resin or compound is to increase the viscosity of the liquid for slope work and/or adjust the evaporation rate of the chemical. This viscous liquid is applied between the two opposing surfaces to be bonded. After a few seconds, pressure is applied to make complete contact. Chemical adhesive seams make use of a dissolved bonding agent (an adherent) in the chemical or bodied chemical which is left after the seam has been completed and cured. The adherent thus becomes an additional element in the system. Contact adhesives are applied to both mating surfaces. After reaching the proper degree of tackiness, the two sheets are placed on top of one another, followed by application of roller pressure. The adhesive forms the bond and is an additional element in the system.

Other emerging seaming methods use ultrasonic, electrical conduction and magnetic induction energy sources. Since these methods are in the developmental stage, they will not be described further in this document. See EPA (1991) for further details.

In order to gain an overview as to which seaming methods are used for the various thermoplastic geomembranes described in this document, Table 3.3 is offered. It is generalized, but it is used to introduce the primary seaming methods versus the type of geomembrane that is customarily seamed by that method.

Table 3.3 Possible Field Seaming Methods for Various Geomembranes Listed in this Manual

| Type of Seaming Method | Type of Geomembrane | | | | | |
|--|---------------------|-------|----------|-----|--------|----------------|
| | HDPE | VLDPE | Other PE | PVC | CSPE-R | Other Flexible |
| extrusion (fillet and flat) | A | A | A | n/a | n/a | A |
| thermal fusion (hot wedge and hot air) | A | A | A | A | A | A |
| chemical (chemical and bodied chemical) | n/a | n/a | n/a | A | A | A |
| adhesive (chemical and contact) | n/a | n/a | n/a | A | A | A |

Note: A = method is applicable
n/a = method is "not applicable"

3.4.2 Details of Field Seaming Methods

Full details of field seaming methods for the edges and ends of geomembrane rolls or panels has recently been described in EPA Technical Guidance Document, EPA/530/SW-91/051, entitled: "Inspection Techniques for the Fabrication of Geomembrane Seams". In this document (EPA, 1991) are separate chapters devoted to the following field seaming methods.

- extrusion fillet seams

- extrusion flat seams
- hot wedge seams
- hot air seams
- chemical and bodied chemical fused seams
- chemical adhesive seams

There is also a section on emerging technologies for geomembrane seaming. The interested reader should consult this document for details regarding all of these seaming methods.

Whenever the plans and specifications are not written around a particular seaming method the actual method which is used becomes a matter of choice for the installation contractor. As seen in Table 3.3, there are a number of available choices for each geomembrane type. Furthermore, even when the installation contractor selects the particular seaming method to be used, its specific details are rarely stipulated even in the specification or CQA documents. This is to give the installation contractor complete latitude in selecting seaming temperatures, travel rates, mechanical roller pressures, chemical type, tack time, hand rolling pressure, etc. The role of the plans, specifications and CQA documents is to adequately provide for destructive tests (on test strips and on production seams) and nondestructive tests (on production seams) to assure that the seams are fabricated to the highest quality and uniformity and are in compliance with the project's documents.

This is not to say that the specification never influences the type of seaming method. For example, if the specifications call for a nondestructive constant air pressure test to be conducted, the installation contractor must use a thermal fusion technique like the dual hot wedge or dual hot air methods since they are the only methods that can produce such a seam.

3.4.3 Test Strips and Trial Seams

Test strips and trial seams, also called qualifying seams, are considered to be an important aspect of CQC/CQA procedures. They are meant to serve as a prequalifying experience for personnel, equipment and procedures for making seams on the identical geomembrane material under the same climatic conditions as the actual field production seams will be made. The test strips are usually made on two narrow pieces of excess geomembrane varying in length between 1.0 to 3.0 m (3 to 10 ft.), see Fig. 3.20. The test strips should be made in sufficient lengths, preferably as a single continuous seam, for all required testing purposes.

The goal of these test strips is to reproduce all aspects of the actual production field seaming activities intended to be performed in the immediately upcoming work session so as to determine equipment and operator proficiency. Ideally, test strips can be used to estimate the quality of the production seams while minimizing damage to the installed geomembrane through destructive mechanical testing. Test strips are typically made every 4 hours (for example, at the beginning of the work shift and after the lunch break). They are also made whenever personnel or equipment are changed and when climatic conditions reflect wide changes in geomembrane temperature or when other conditions occur that could affect seam quality. These details should be stipulated in the contract specifications or CQA documents.

The destructive testing of the test strips should be done as soon as the installation contractor feels that the strength requirements of the contract specification or CQA documents can be met. Thus it behooves the contractor to have all aspects of the test strip seam fabrication in complete

working order just as would be done in the case of fabricating production field seams. For extrusion and thermal fusion seams, destructive testing can be done as soon as the seam cools. For chemical fusion and adhesive seams this could take several days and the use of a field oven to accelerate the curing of the seam is advisable.

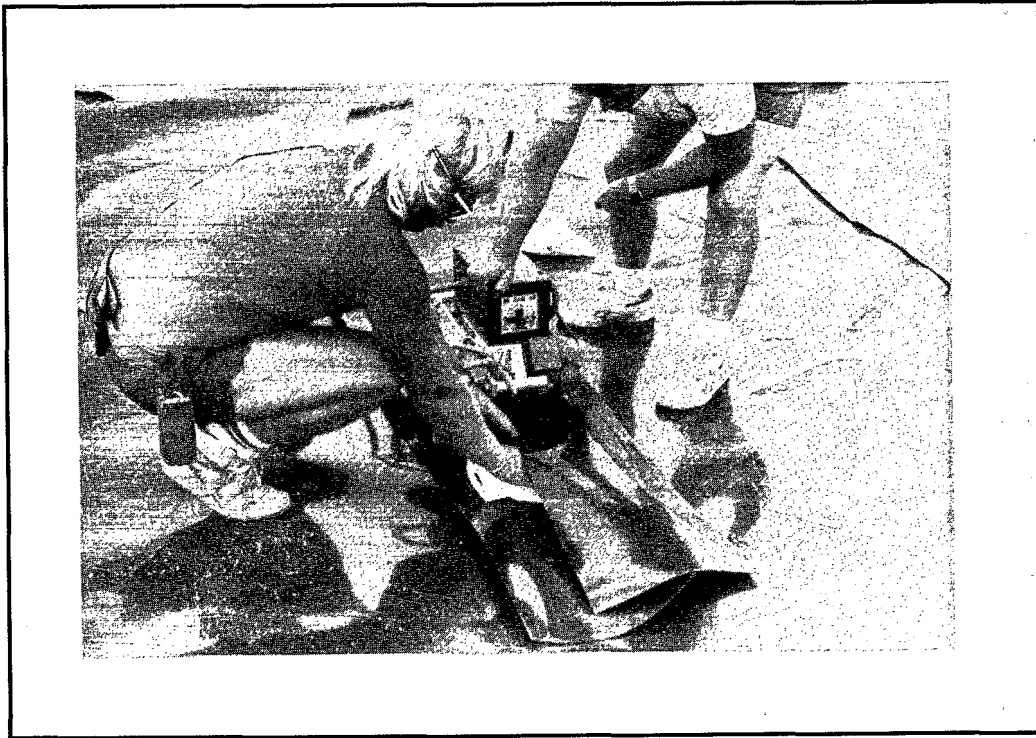

Figure 3.20 - Fabrication of a Geomembrane Test Strip

From two to six test specimens are cut from the test strip using a 25 mm (1.0 in. wide die). They are selected at random by the CQA inspector. The specimens are then tested in both peel and shear using a field tensiometer, see Fig. 3.21. (Generally peel tests are more informative in assessing the quality of the seam). If any of the test specimens fail, a new test strip is fabricated. If additional specimens fail, the seaming apparatus and seamer should not be accepted and should not be used for seaming until the deficiencies are corrected and successful trial welds are achieved. The CQA inspector should observe all trial seam procedures and tests. If the specimens pass, seaming operations can move directly to production seams in the field. Pass/fail criteria for destructive seam tests will be described in Section 3.5.

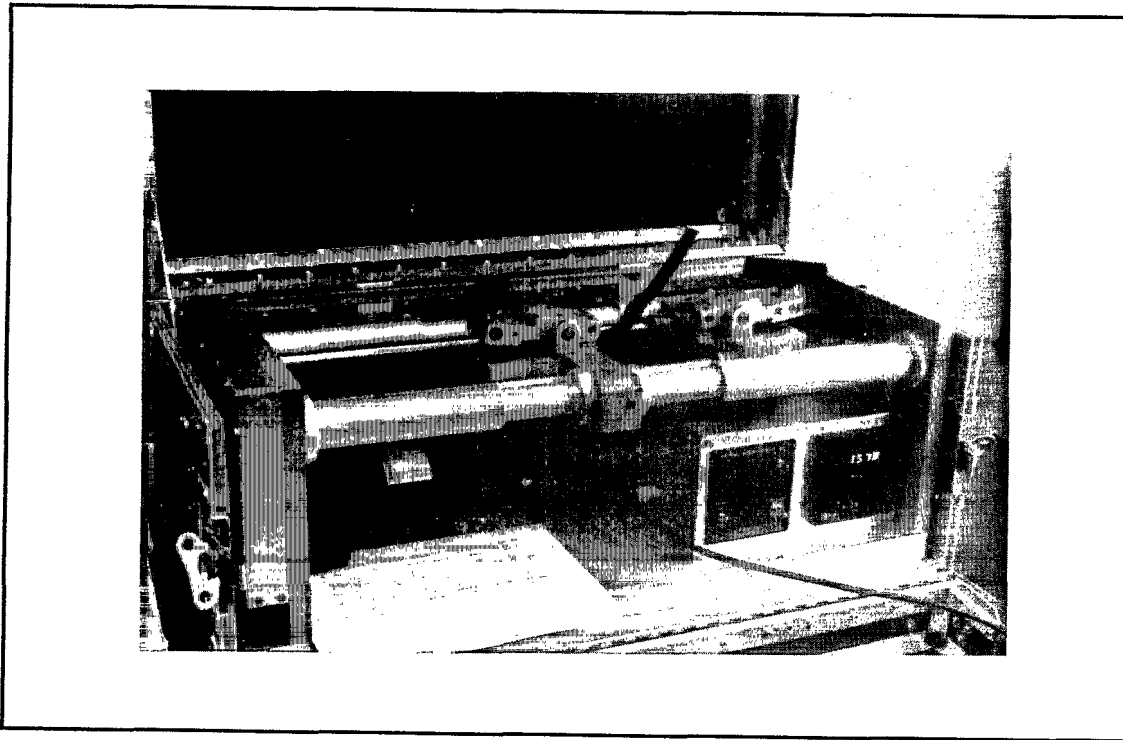

Figure 3.21 - Photograph of a Field Tensiometer Performing a Geomembrane Seam Test

The flow chart illustrated in Fig. 3.22 gives an idea of the various decisions that can be reached depending upon the outcome of destructive tests on test strip specimens. Here it is seen that failed test strips are linked to an increased frequency of destructive tests to be taken on production field seams made during the time interval between making the test strip and its testing. Furthermore, it is seen that there are only two chances at making adequate test strips before production field seaming is stopped and repairs are initiated. These details should be covered in either the project specification or the CQA documents.

Some specification or CQA document items regarding the fabrication of geomembrane seam test strips include the following:

1. The frequency of making test strips should be clearly stated. Typically this is at the beginning of the day, after the noon break and whenever changed conditions are encountered, e.g., changes in weather, equipment, personnel.
2. The CQA Engineer should have the option of requesting test strips of any field seaming crew or device at any time.

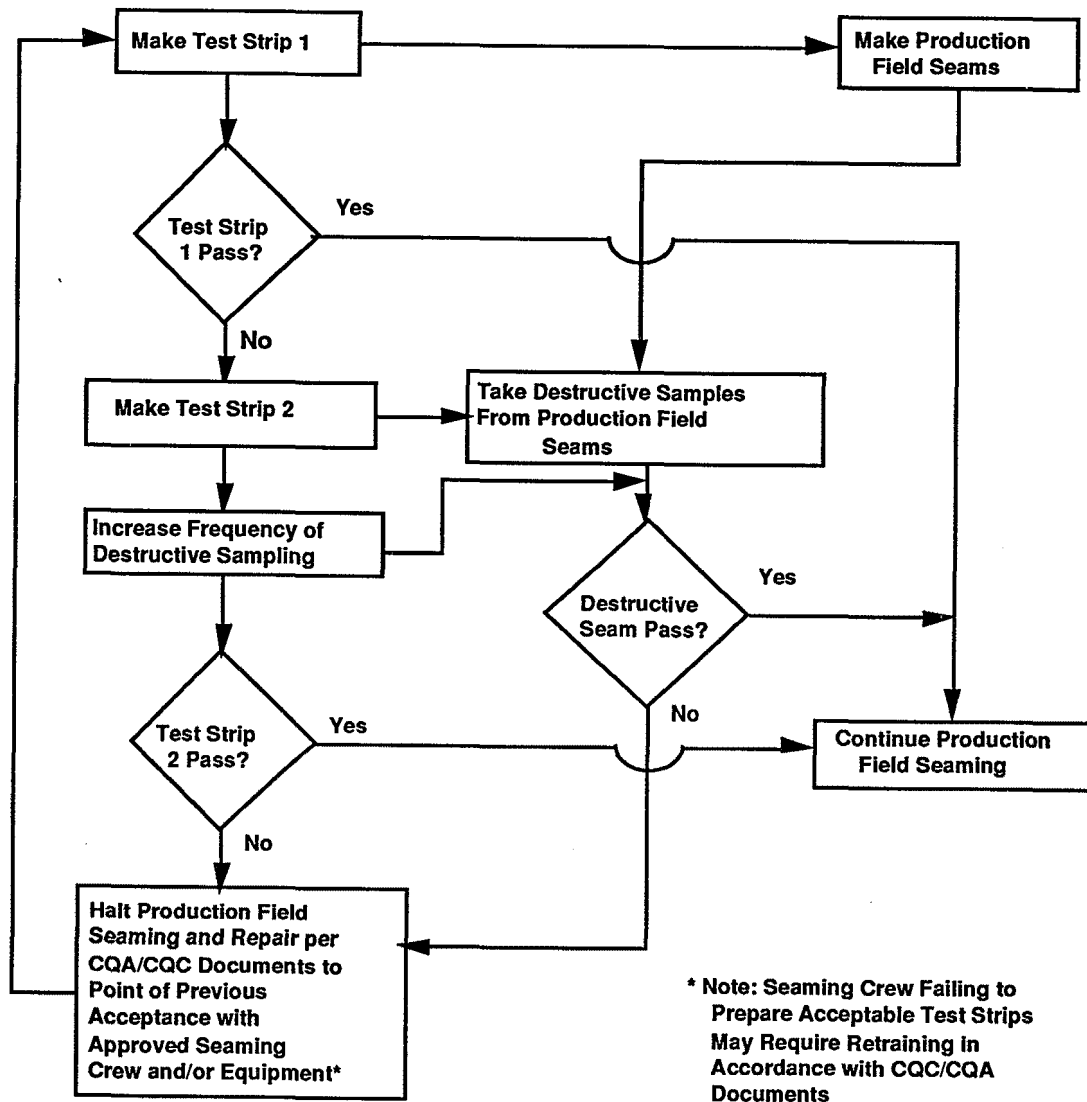

Figure 3.22 - Test Strip Process Flow Chart

3. The procedure for sampling and evaluating the field test strip samples should be clearly outlined, i.e., the number of peel and shear test specimens to be cut and tested from the test strip sample, the rate of testing and what the required strength values are in these two different modes of testing.
4. The fabrication of the field test strip and testing of test specimens should be observed by the CQA personnel.

5. The time for testing after the test strip is fabricated varies between seam types. For extrusion and fusion fabricated seams, the testing can commence immediately after the polymer cools to ambient temperature. For chemical fusion and adhesive fabricated seams, the testing must wait until adequate curing of the seam occurs. This can take as long as 1 to 7 days. During this time all production seaming must be tracked and documented.
6. Accelerated oven curing of chemical and adhesive fabricated seams is acceptable so as to hasten the curing process and obtain test results as soon as possible. GRI Test Method GM-7 can be used for this purpose.
7. The required inspection protocol and implications of failed test specimens from the test strips must be clearly stated. The protocol outlined in Fig. 3.22 is suggested.
8. Field test strips are usually discarded after the destructive test specimens are removed and tested. If this is not the case, it should be clearly indicated who receives the test strip samples and what should be the utilization (if any) of these samples.

3.5 Destructive Test Methods for Seams

The major reason that plans and specifications do not have to be specific about the type of seaming methods and their particular details is that geomembrane seams can be readily evaluated for their quality by taking samples and destructively testing them either at the job site or in a timely manner at a testing laboratory thereafter.

3.5.1 Overview

By destructively testing geomembrane seams it is meant to actually cut out (i.e., to sample) and remove a portion of the completed production seam, and then to further cut the sample into appropriately sized test specimens. These specimens are then tested according to a specified procedure to failure or to yield depending upon the type of geomembrane.

A possible procedure is to select the sampling location and cut two closely spaced 25 mm (1.0 in.) wide test specimens from the seam. The distance between these two test specimens is defined later. The individual specimens are then tested in a peel mode using a field tensiometer (recall Fig. 3.21). If the results are acceptable, the complete seam between the two field test specimens is removed and properly identified and distributed. If either test specimen fails, two new locations on either side of the failed specimen(s) are selected until acceptable seams are located. The seam distance between acceptable seams is usually repaired by cap-stripping but other techniques are also possible. The exact procedure must be stipulated in the specifications or CQA document.

The length dimension of the field seam sample between the two test specimens just described varies according to whatever is stipulated in the plans and specifications, or in accordance with the CQA documents. Some common options are to sample the seam for a distance of either 36 cm (14 in.), 71 cm (28 in.) or 106 cm (42 in.) along its length. Since the usual destructive seam tests are either shear or peel tests and both types are 25 mm (1.0 in.) wide test specimens, this allows for approximately 10, 20 or 30 tests (half shear and half peel) to be conducted on the respective lengths cited above. The sample width perpendicular to the seam is usually 30 cm (12 in.) with the seam being centrally located within this dimension.

The options of seam sample length between the two peel test specimens mentioned above that are seen in various plans, specifications, and CQA documents, are as follows:

- A 36 cm (14 in.) sample is taken from the seam and cut into 5 shear and 5 peel specimens. The tests are conducted in the field or at a remote laboratory by, or under the direction of, the responsible CQA organization.
- A 71 cm (28 in.) long sample is taken from the seam and cut in half. One half is further cut into 5 shear and 5 peel test specimens which are tested in the field or at a remote laboratory by the CQC organization (usually the installation contractor). The other half is sent to a remote laboratory for testing by the CQA organization who also does 5 shear and 5 peel tests. Alternatively, sometimes only the CQA organization does the testing and the second half of the sample is left intact and archived by the owner/operator.
- A 106 cm (42 in.) long sample is taken from the seam and cut into three individual 36 cm (14 in.) samples. Individual samples go to the CQC organization, the CQA organization and the owner/operator. The CQC and CQA organizations each cut their respective samples into 5 shear and 5 peel test specimens and conduct the appropriate tests immediately. The remaining sample is archived by the owner/operator.

Whatever is the strategy for taking samples from the production seams for destructive testing it must be clearly outlined in the contract plans and specifications and further defined and/or corroborated in the CQA documents.

Obviously, the hole created in the production seam from which the test sample was originally taken must be patched in an appropriate manner. See Fig. 3.23 for such a patched sampling location. Recognize that the seams of such patches are themselves candidates for field sampling and testing. If this is done, one would have the end result of patch on a patch, which is a rather unsightly and undesirable condition.

3.5.2 Sampling Strategies

The sampling of production seams of installed geomembranes represents a dilemma of major proportions. Too few samples results in a poor statistical representation of the strength of the seam, and too many samples requires an additional cost and a risk of having the necessary repair patches being problems in themselves. Unfortunately, there is no clear strategy for all cases, but the following are some of the choices that one has in formulating a specification or CQA plan.

Note also that in selecting a sampling strategy the sampling frequency is tied directly into the performance of the test strips described in Section 3.4.3. If the test strips fail during the time that production seaming is ongoing, the frequency of destructive sampling and testing must be increased. The following strategies, however, are for situations where geomembrane seam test strips are being made in an acceptable manner.

3.5.2.1 Fixed Increment Sampling

By far the most commonly used sampling strategy is the “fixed increment sampling” method. In this method, a seam sample is taken at fixed increments along the total length of the seams. Increments usually range from 75 to 225 m (250 to 750 ft) with a commonly specified value being one destructive test sample every 150 m (500 ft). Note that this value can be applied either directly to the record drawings during layout of the seams, to each seaming crew as they progress during the work period, or to each individual seaming device. Once the increment is

decided upon, it should be held regardless of the location upon which it falls, e.g., along side slopes, in sumps, etc. Of course, if the CQA documents allow otherwise, exceptions such as avoiding sumps, connections, protrusions, etc. can be made.



Figure 3.23 - Completed Patch on a Geomembrane Seam Which had Previously Been Sampled for Destructive Tests

3.5.2.2 Randomly Selected Sampling

In random selection of destructive seam sample locations it is first necessary to preselect a preliminary estimate of the total number of samples to be taken. This is done by taking the total seam length of the facility and dividing it by an arbitrary interval, e.g., 150 m (500 ft), to obtain the total number of samples that are required. Two choices to define the actual sampling locations

are now available: “stratified” random sampling, or “strict” random sampling. The stratified method takes each pre-selected interval (e.g., a 150 m (500 ft) length) and randomly selects a single sample location within this interval. Thus with stratified random sampling one has location variability within a fixed increment (unlike fixed frequency sampling which is always at the exact end of the increment). The strict method uses the total seam length of the facility (or cell) and randomly selects sample locations throughout the facility up to the desired number of samples. Thus with strict random sampling a group of samples may be taken in close proximity to one another, which necessarily leaves other areas with sparse sampling.

There are various ways of randomly selecting the specific location within an interval, e.g., in a specific region of great concern, or within the total project seam length. These are as follows:

- Use a random number generator from statistical tables to predetermine the sampling locations within each interval or for the entire project.
- Use a programmable pocket calculator with a random number generator program to select the sampling location in the field for each interval or for the entire project.
- Use a random number obtained by simply multiplying two large numbers together to form an 8-digit result. A pocket calculator with an adequate register will be necessary. The center two digits in such a procedure are quite randomly distributed and can be used to obtain the sampling location. For example, multiplication of the following two numbers “4567” by 4567” gives 20857489 where the central two digits, i.e., the “57”, are used to select the location within the designated sampling interval. If this interval were 500 ft., the sampling location within it would be at $0.57 \times 500 = 285$ ft. from the beginning of the interval. The next location of the sample would require a new calculation resulting in a different central two-digit number somewhere within the next 500 ft. sampling interval and would be located in a similar fashion.

3.5.2.3 Other Sampling Strategies

There are two other sampling strategies which might be selected in determining how many destructive seam samples should be taken. Both are variable strategies in that repeated acceptable seam tests are rewarded by requiring fewer samples and repeated failures are penalized by requiring more frequent samples. These two strategies are called the “method of attributes” and the use of “control charts”. Both set upper and lower bounds which require either fewer or more frequent testing than the initially prescribed sampling frequency. Each of these methods are described fully in Richardson (1992).

Whatever the sampling strategy used, it should never limit or prohibit the ability to select a destructive seam sample from a suspect area. This should ultimately be an option left to the CQA engineer.

3.5.3 Shear Testing of Geomembrane Seams

Shear testing of specimens taken from field fabricated geomembrane seams represents a reasonably simulated performance test. The possible exception is that a normal stress is not applied to the surfaces of the test specimen thus it is an “unconfined” tension test. A slight rotation may be induced during tensioning of the specimen, making the actual test results tend toward conservative values. The configuration of a shear test in a tension testing machine is shown in Fig. 3.24.

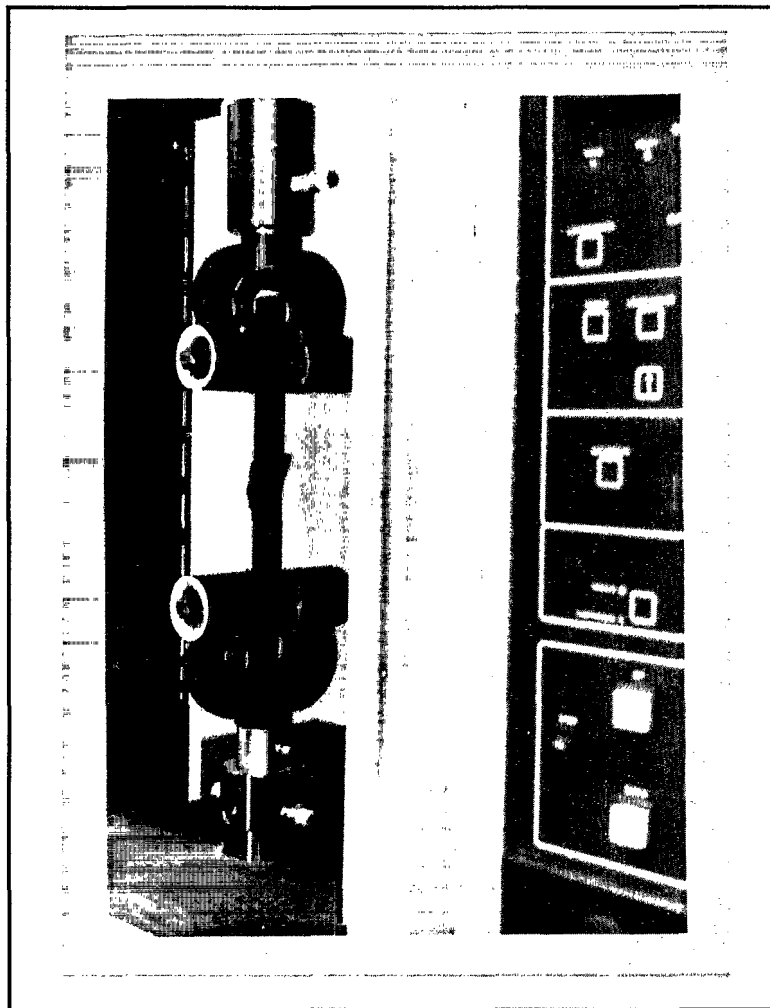

Figure 3.24 - Shear Test of a Geomembrane Seam Evaluated in a CQC/CQA Laboratory Environment

Commonly recommended shear tests for HDPE, PVC, CSPE-R and EIA-R seams, along with the methods of testing the unseamed sheet material in tension, are given in Table 3.4. The VLDPE data presented was included in a way so as to parallel the HDPE testing protocol except for the strain rate values which are faster since breaking values, rather than yield values are required. There is no pronounced yield value when tensile testing VLDPE geomembranes.

Table 3.4 Recommended Test Method Details for Geomembrane Seams in Shear and in Peel and for Unseamed Sheet

| Type of Test | HDPE | VLDPE | PVC | CSPE-R |
|------------------------------|----------------|----------------|----------------|------------------|
| Shear Test on Seams | | | | |
| ASTM Test Method | D4437 | D4437 | D3083 | D751 |
| Specimen Shape | Strip | Strip | Strip | Grab |
| Specimen Width (in.) | 1.00 | 1.00 | 1.00 | 4.00 (1.00 grab) |
| Specimen Length (in.) | 6.00 + seam | 6.00 + seam | 6.00 + seam | 9.00 + seam |
| Gage Length (in.) | 4.00 + seam | 4.00 + seam | 4.00 + seam | 6.00 + seam |
| Strain Rate (ipm) | 2.0 | 20 | 20 | 12 |
| Strength (psi) or (ppi) | Force/(1.00×t) | Force/(1.00×t) | Force/(1.00×t) | Force |
| Peel Test on Seams | | | | |
| ASTM Test Method | D4437 | D4437 | D413 | D413 |
| Specimen Shape | Strip | Strip | Strip | Strip |
| Specimen Width (in.) | 1.00 | 1.00 | 1.00 | 1.00 |
| Specimen Length (in.) | 4.00 | 4.00 | 4.00 | 4.00 |
| Gage Length (in.) | n/a | n/a | n/a | n/a |
| Strain Rate (ipm) | 2.0 | 20 | 2.0 | 2.0 |
| Strength (psi) or (ppi) | Force/(1.00×t) | Force/(1.00×t) | Force/1.00 | Force/1.00 |
| Tensile Test on Sheet | | | | |
| ASTM Test Method | D638 | D638 | D882 | D751 |
| Specimen Shape | Dumbbell | Dumbbell | Strip | Grab |
| Specimen Width (in.) | 0.25 | 0.25 | 1.00 | 4.00 (1.00 Grab) |
| Specimen Length (in.) | 4.50 | 4.50 | 6.00 | 6.00 |
| Gage Length (in.) | 1.30 | 1.30 | 2.00 | 3.00 |
| Strain Rate (ipm) | 2.0 | 20 | 20 | 12 |
| Strength (psi) or (lb) | Force/(0.25×t) | Force/(0.25×t) | Force/(1.00×t) | Force |
| Strain (in./in.) | Elong./1.30 | Elong./1.30 | Elong./2.00 | Elong./3.00 |
| Modulus (psi) | From Graph | From Graph | From Graph | n/a |

where n/a = not applicable
t = geomembrane thickness
psi = pounds/square inch of specimen cross section
ppi = pounds/linear inch width of specimen
ipm = inches/minute
Force = maximum force attained at specimen failure (yield or break)

Insofar as the shear testing of nonreinforced geomembrane seams (HDPE, VLDPE and PVC), all use a 25 mm (1.0 in.) wide test specimen with the seam being centrally located within the testing grips. For the reinforced geomembranes (CSPE-R and EIA-R) a “grab” test specimen is used. In a grab tension test the specimen is 200 mm (4.0 in.) wide but is only gripped in the central 25 mm (1.0 in.). The test specimen is tensioned, at its appropriate strain rate, until failure occurs. If the seam delaminates (i.e., pulls apart in a seam separation mode), the seam fails in what is called a “non-film tear bond”, or non-FTB. In this case, it is rejected as a failed seam. Details on various types of seam failures and on the interpretation of FTB are found in Haxo (1988). Conversely, if the seam does not delaminate, but fails in the adjacent sheet material on either side of the seam, it is an acceptable failure mode, i.e., called a “film tear bond”, or FTB, and the seam strength is then calculated.

The seam strength (for HDPE, VLDPE and PVC) is the maximum force attained divided by either the original specimen width (resulting in units of force per unit width), or the original specimen cross sectional area (resulting in units of stress). It is general procedure to use force per unit width as it is an absolute strength value which can be readily compared to other test results. If stress units are desired, one can use the nominal thickness of the geomembrane, or continuously measure the actual thickness of each test specimen. This latter alternative requires considerable time and effort and is generally not recommended. The procedure is slightly different for the reinforced geomembranes (CSPE-R and EIA-R) which use a grab test method. Here the strength is based on the maximum tensile force that can be mobilized and a stress value is not calculated.

The resulting value of seam shear strength is then compared to the required seam strength (which is the usual case) or to the strength of the unseamed geomembrane sheet. If the latter, the procedures for obtaining this value are listed in Table 3.4. In each case the test protocol for seam and sheet are the same, except for HDPE and VLDPE. The sheet strength value for these polyethylene geomembranes are based on a ASTM D-638 “dumbbell-shaped” specimens, although the strength is calculated on the reduced section width. With all of these sheet tension tests, the nominal thickness of the unseamed geomembrane sheet is used for the comparison value. If actual thickness of the sheet is considered, the results will be reflected accordingly. Note, however, that this will require a large amount of additional testing (to get average strength values) and is not a recommended approach.

Knowing the seam shear strength and the unseamed sheet strength (ether by a specified value or by testing), allows for a seam shear efficiency calculation to be made as follows:

$$E_{\text{shear}} = \frac{T_{\text{seam in shear}}}{T_{\text{unseamed sheet}}} \quad (100) \quad (3.1)$$

where

E_{shear} = seam efficiency in shear (%)

T_{seam} = seam shear strength (force or stress units)

T_{sheet} = sheet tensile strength (force or stress units)

The contract plans, specifications or CQA documents should give the minimum allowable seam shear strength efficiency. As a minimum, the guidance listed below can be used whereby

percentages of seam shear efficiencies (or values) are listed:

HDPE = 95% of specified minimum yield strength
VLDPE = typically 1200 lb/in²
PVC = 80%
CSPE-R = 80% (for 3-ply reinforced)
EIA-R = 80%

Generally an additional requirement of a film tear bond, or FTB, will also be required in addition to a minimum strength value. This means that the failure must be located in the sheet material on either side of the seam and not within the seam itself. Thus the seam cannot delaminate.

Lastly, the number of failures allowed per number of tests conducted should be addressed. If sets of 5 test specimens are performed for each field sample, many specifications allow for one failure out of the five tested. If the failure number is larger, then the plans, specifications or CQA documents must be clear on the implications.

When a destructive seam test sample fails, many specifications and CQA documents require two additional samples to be taken, one on each side of the original sample each spaced 3 m (10 ft) from it. If either one of these samples fail, the iterative process of sampling every 3 m (10 ft) is repeated until passing test results are observed. In this case the entire seam between the two successful test samples must be questioned. For example, remedies for polyethylene geomembranes are to cap strip the entire seam or if the seam is made with a thermal fusion method (hot air or hot wedge) to extrude a fillet weld over the outer seam edge. When such repairs are concluded the seams on the cap strip or extrusion fillet weld should be sampled and tested as just described.

Note that elongation of the specimens during shear testing is usually not monitored (although current testing trends are in this direction), the only value under consideration is the maximum force that the seam can sustain. It should also be mentioned that the test is difficult to perform on the inside of the tracks facing the air channel of a dual channel thermal fusion seam. For small air channels the tab available for gripping will be considerably less than that required in test methods as given in Table 3.4. Regarding the testing of the inside or outside tracks (away from the air channel) of a dual channel thermal fusion seam, or even both tracks, the specification or CQA document should be very specific.

3.5.4 Peel Testing of Geomembrane Seams

Peel testing of specimens taken from field fabricated geomembrane seams represent a quality control type of index test. Such tests are not meant to simulate in-situ performance but are very important indicators of the overall quality of the seam. The configuration of a peel test in a tension testing machine is shown in Fig. 3.25.

The recommended peel tests for HDPE, PVC, CSPE-R and EIA-R seams, along with the unseamed sheet material in tension are given in Table 3.4. The VLDPE data was included in a way so as to parallel the HDPE testing protocol.

Insofar as the peel testing of geomembrane seams is concerned, it is seen that all of the geomembranes listed have a 25 mm (1.0 in.) width test specimen. Furthermore, the specimen lengths and strain rate are also equal for all geomembrane types. The only difference is that HDPE and VLDPE use the thickness of the geomembrane to calculate a tensile strength value in stress

units, whereas PVC, CSPE-R and EIA-R calculate the tensile strength value in units of force per unit width, i.e., in units of pounds per linear inch of seam.

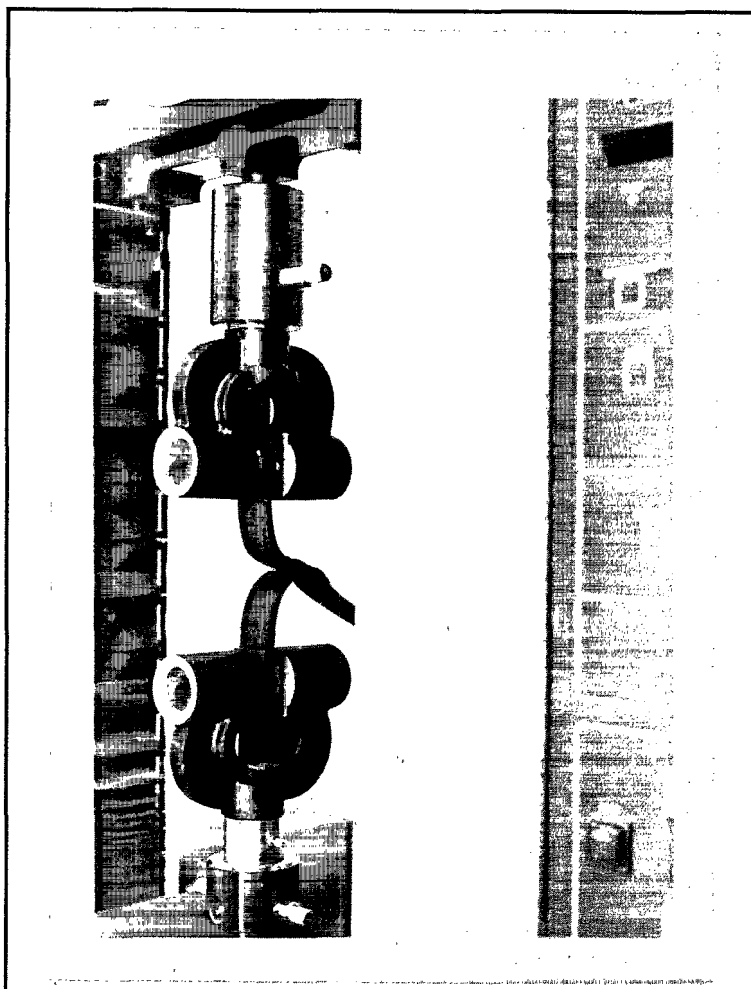

Fig. 3.25 - Peel Test of a Geomembrane Seam Evaluated in a CQC/CQA Laboratory Environment

In a peel test the test specimen is tensioned, at its appropriate strain rate, until failure occurs. If the seam delaminates (i.e., pulls apart in a seam separation mode), it is called a “non-film tear bond or non-FTB”, and is recorded accordingly. Conversely, if the seam does not delaminate, but fails in the adjacent sheet material on either side of the seam it is called a “film tear bond or FTB” and the seam strength is calculated. Details on various types of seam failures and on the interpretation of FTB are found in Haxo (1988). The seam strength is the maximum force attained divided by the specimen width (resulting in units of force per unit width), or by the specimen cross sectional area (resulting in units of stress). The former procedure is the most common, i.e., peel strengths are measured in force per unit width units. If stress units are desired the thickness of the

geomembrane sheet must be included. The nominal sheet thickness is usually used. If the actual sheet thickness is used, a large amount of thickness measurements will be required to obtain a statistically reliable value. It is not a recommended procedure.

The resulting value of seam peel strength is then compared to a specified value (the usual case) or to the strength of the unseamed geomembrane sheet. The testing procedures for obtaining these values are listed in Table 3.4. It can be seen, however, that only with PVC is the same width test specimen used for peel and sheet testing. For HDPE and VLDPE one is comparing a 1.0 in. uniform width peel test with a dumbbell shaped specimen, while for CSPE-R and EIA-R one is comparing a uniform width peel test with the strength from a grab shaped test specimen. If, however, one does have a specified sheet strength value or a measured value, a seam peel strength efficiency calculation can be made as follows:

$$E_{\text{peel}} = \frac{T_{\text{seam in peel}}}{T_{\text{unseamed sheet}}} \quad (100) \tag{3.2}$$

where

- E_{peel} = seam efficiency in peel (%)
- T_{seam} = seam peel strength (force or stress units)
- T_{sheet} = sheet tensile strength (force or stress units)

The contract plans, specifications or CQA documents should give the minimum allowable seam peel strength efficiency. As a minimum, the guidance listed below can be used whereby percentage peel efficiencies (or values) are listed as follows:

- HDPE = 62% of specified minimum yield strength and FTB
- VLDPE = typically 1000 lb/in²
- PVC = 10 lb/in.
- CSPE-R = 10 lb/in. or FTB
- EIA-R = 10 lb/in.

Lastly, the number of failures allowed per number of tests conducted should be addressed. If sets of 5 test specimens are performed for each field sample, many specifications allow for one failure out of the five tested. If the failure number is larger, then the plans, specifications or CQA documents must be clear on the implications.

When a destructive seam test sample fails, many specifications require an additional two samples to be taken, one on each side of the original spaced 3 m (10 ft) from it. If either one of these samples fail the iterative process of sampling every 3 m (10 ft) is repeated until successful samples result. In this case, the entire seam between the last successful test samples must be questioned. Remedies are to cap strip the entire seam or if the seam is HDPE or VLDPE made with a thermal fusion method (hot air or hot wedge) to extrude a fillet weld over the outer seam edge. When this is done the seams on the cap strip or extrusion fillet weld may be sampled and tested as just described.

Note that neither elongation of the specimen nor peel separation, during the test is usually monitored (although current testing trends are in this direction), the only value under consideration is the maximum tensile force that the seam can sustain. It should also be mentioned that both forward and backward peel tests can be performed thereby challenging both sides of a seam. For

dual channel seams, both insides of the tracks facing the air channel can be tested, but due to the narrow width of most air channels the tab available for gripping will be considerably less than that given in Table 3.4. Regarding the testing of the inside or outside tracks (away from the air channel) of a dual channel seam, or even both tracks, the specification or CQA document should be very specific.

3.5.5 General Specification Items

Regarding field sampling of geomembrane seams and their subsequent destructive testing, a specification or CQA document should consider the following items.

1. CQA personnel should observe all production seam sample cutting.
2. All samples should be adequately numbered and marked with permanent identification.
3. All sample locations should be indicated on the geomembrane layout (and record) drawings.
4. The reason for taking the sample should be indicated, e.g., statistical routine, suspicious feature, change in sheet temperature, etc.
5. The sample dimensions should be given insofar as the length of sample and its width. The seam will generally be located along the center of the length of the sample.
6. The distribution of various portions of the sample (if more than one) should be specified.
7. The number of shear and peel tests to be conducted on each sample (field tests and laboratory tests) should be specified.
8. The specifics of conducting the shear and peel tests should be specified, e.g., use of actual sheet thickness, or of nominal sheet thickness. The following are suggested ASTM test methods for each geomembrane type:

| <u>Geomembrane</u> | <u>Seam Shear Test</u> | <u>Seam Peel Test</u> | <u>Sheet Test</u> |
|--------------------|------------------------|-----------------------|-------------------|
| HDPE | D-4437 | D-4437 | D-638 |
| VLDPE | D-4437 | D-4437 | D-638 |
| PVC | D-3083 | D-413 | D-882 |
| CSPE-R | D-751 | D-413 | D-751 |
| EIA-R | D-751 | D-751 | D-751 |

9. The CQA personnel should witness all field tests and see that proper identification and details accompany the test results. Details should be provided in the CQA documents. Such details as follows are often required.

- date and time
 - ambient temperature
 - identification of seaming unit, group or machine
 - name of master seamer
 - welding apparatus temperature and pressure, or chemical type and mixture
 - pass or fail description
 - a copy of the report should be attached to the remaining portion of the sample
10. The CQA personnel should verify that samples sent to the testing laboratory are properly marked, packaged and shipped so as not to cause damage.
 11. Results of the laboratory tests should come to the CQA Engineer in a stipulated time. For extrusion and thermally bonded seams, verbal test results are sometimes required with 24 to 72 hours after the laboratory receives the samples. For chemically bonded seams, the time frame is longer and depends on whether or not accelerated heat curing of the seams is required. In all cases, the CQA Engineer must inform the Owner's representative of the results and make appropriate recommendations.
 12. The procedures for seam remediation in the event of failed destructive tests should be clear and unequivocal. Options usually are (a) to repair the entire seam between acceptable sampling locations, or (b) to retest the seam on both sides in the vicinity of the failed sample. If they are acceptable only this section of the seam is repaired. If they are not, a wider spaced set of samples are taken and tested.
 13. Repairs to locations where destructive samples were removed should be stipulated. These repairs are specific to the type of geomembrane and to the seaming method. Guidance in this regard is available in EPA (1991).
 14. Each repair of a patched seam where a test sample had been removed should be verified. This is usually done by an appropriate nondestructive test. If, however, the sampling strategy selected calls for a destructive test to be made at the exact location of a patch it should be accommodated. Thus the final situation will require a patch to be placed on an earlier patch. If this (unsightly) detail is to be avoided, it should be stated outright in the specifications or CQA document.
 15. The time required to retain and store destructive test samples on the part of the CQC and CQA organizations should be stipulated.

3.6 Nondestructive Test Methods for Seams

3.6.1 Overview

Although it is obviously important to conduct destructive tests on the fabricated seams, such tests do not give adequate information on the continuity and completeness of the entire seam between sampling locations. It does little good if one section of a seam meets the specification requirements, only to have the section next to it missed completely by the field-seaming crew.

Thus continuous methods of a nondestructive testing (NDT) nature will be discussed here. In each of these methods the goal is to validate 100% of the seams or, at minimum, a major percentage of them.

3.6.2 Currently Available Methods

The currently available NDT methods for evaluating the adequacy of geomembrane field seams are listed in Table 3.5 in the order that they will be discussed.

The *air lance* method uses a jet of air at approximately 350 kPa (50 lb/in.²) pressure coming through an orifice of 5 mm (3/16 in.) diameter. It is directed beneath the upper edge of the overlapped seam and is held within 100 mm (4.0 in.) from the edge of the seamed area in order to detect unbonded areas. When such an area is located, the air passes through the opening in the seam causing an inflation and fluttering in the localized area. A distinct change in sound emitted can generally be heard. The method works best on relatively thin, less than 1.1 mm (45 mils), flexible geomembranes, but works only if the defect is open at the front edge of the seam, where the air jet is directed. It is essentially a geomembrane installer's method to be used in a construction quality control (CQC) manner.

The *mechanical point stress* or "*pick*" test uses a dull tool, such as a blunt screw-driver, under the top edge of a seam. With care, an individual can detect an unbonded area, which would be easier to separate than a properly bonded area. It is a rapid test that obviously depends completely on the care and sensitivity of the person doing it. Detectability is similar to that of using the air lance, but both are very operator-dependent. This test is to be performed only by the geomembrane installer as a CQC method. Design or inspection engineers should not use the pick test but rather one or more of the techniques to be discussed later.

The *pressurized dual seam* method was mentioned earlier in connection with the dual hot wedge or dual hot air thermal seaming methods. The air channel that results between the dual bonded tracks is inflated using a hypodermic needle and pressurized to approximately 200 kPa (30 lb/in.²). There is no limit as to the length of the seam that is tested. If the pressure drop is within an allowable amount in the designated time period (usually 5 minutes), the seam is acceptable; if a unacceptable drop occurs, a number of actions can be taken:

- The distance can be systematically halved until the leak is located.
- The section can be tested by some other leak detection method.
- An extrusion fillet weld can be placed over the entire edge.
- A cap strip can be seamed over the entire edge.

Details of the test can be found in GRI Test Method GM6. The test is an excellent one for long, straight-seam lengths. It is generally performed by the installation contractor, but usually with CQA personnel viewing the procedure and documenting the results.

Table 3.5 - Nondestructive Geomembrane Seam Testing Methods, Modified from Richardson and Koerner (1988)

| Nondestructive Test Method | Primary User | | General Comments | | | | | |
|---------------------------------------|--------------|-----|-------------------|----------------|---------------|----------------|----------------------|---------------------|
| | CQC | CQA | Cost of Equipment | Speed of Tests | Cost of Tests | Type of Result | Recording Method | Operator Dependency |
| 1. air lance | yes | --- | \$200 | fast | low | yes-no | manual | high |
| 2. mechanical point (pick) stress | yes | --- | nil | fast | nil | yes-no | manual | very high |
| 3. dual seam (positive pressure) | yes | --- | \$200 | fast | moderate | yes-no | manual | low |
| 4. vacuum chamber (negative pressure) | yes | yes | \$1000 | slow | very high | yes-no | manual | moderate |
| 5. electric wire | yes | yes | \$500 | fast | nil | yes-no | manual | high |
| 6. electric field | yes | yes | \$20,000 | slow | high | yes-no | manual and automatic | low |
| 7. ultrasonic pulse echo | --- | yes | \$5000 | moderate | high | yes-no | automatic | moderate |
| 8. ultrasonic impedance | --- | yes | \$7000 | moderate | high | qualitative | automatic | unknown |
| 9. ultrasonic shadow | --- | yes | \$5000 | moderate | high | qualitative | automatic | moderate |

The *vacuum chamber (box)* method uses a box up to 1.0 m (3 ft) long with a transparent top that is placed over the seam; a vacuum of approximately 20 kPa (3 lb/in.²) is applied. When a leak is encountered the soapy solution originally placed over the seam shows bubbles thereby reducing the vacuum. This is due to air entering from beneath the geomembrane and passing through the unbonded zone. The test is slow to perform (a 10 sec dwell time is currently recommended) and is often difficult to make a vacuum-tight joint at the bottom of the box where it passes over the seam edges. Due to upward deformations of the liner into the vacuum box, only geomembrane thickness greater than 1.0 mm (40 mils) should be tested in this manner. For thinner, more flexible geomembranes an open grid wire mesh can be used along the bottom of the box to prevent uplift. It should also be noted that vacuum boxes are the most common form of nondestructive test currently used by design engineers and CQA inspectors for polyethylene geomembranes. It should be recognized that 100% of the field seams cannot be inspected by this method. The test cannot cover portions of sumps, anchor trenches, and pipe penetrations with any degree of assurance. The method is also very awkward to use on side slopes. The adequate downward pressure required to make a good seal is difficult to mobilize since it is usually done by standing on top of the box.

Electric sparking (not mentioned in Table 3.5) is a technique used to detect pinholes in thermoplastic liners. The method uses a high-voltage (15 to 30 kV) current, and any leakage to ground (through an opening or hole) results in sparking. The method is being investigated for possible field use. The *electric wire* method places a copper or stainless steel wire between the overlapped geomembrane region and actually embeds it into the completed seam. After seaming, a charged probe of about 20,000 volts is connected to one end of the wire and slowly moved over the length of the seam. A seam defect between the probe and the embedded wire results in an audible alarm from the unit.

The *electric field* test utilizes a potential which is applied across the geomembrane by placing a positive electrode in water within the geomembrane and a ground electrode in the subgrade or in the sump of the leak detection system. A current will only flow between the electrodes through a hole (leak) in the geomembrane. The potential gradients in the ponded water are measured by "walking" the area with a previously calibrated probe. The operator walks along a calibration grid layout and identifies where anomalies exist. Holes less than 1 mm diameter can be identified. These locations can be rechecked after the survey is completed by other methods, such as the vacuum box. In deep water, or for hazardous liquids, a remote probe can be dragged from one side of the impoundment to the other across the surface of the geomembrane. On side slopes that are not covered by water, a positively charged stream of water can be directed onto the surface of the geomembrane. When the water stream encounters and penetrates a hole, contact with the subgrade is made. At this point current flow is indicated, thus locating the hole. Pipe penetrations through the geomembrane and soil cover that goes up the side slope and contacts the subgrade reduce the sensitivity of the method.

The last group of nondestructive test methods noted in Table 3.5 can collectively be called *ultrasonic methods*. A number of ultrasonic methods are available for seam testing and evaluation. The *ultrasonic pulse echo* technique is basically a thickness measurement technique and is only for use with nonreinforced geomembranes. Here a high-frequency pulse is sent into the upper geomembrane and (in the case of good acoustic coupling and good contact between the upper and lower sheets) reflects off of the bottom of the lower one. If, however, an unbonded area is present, the reflection will occur at the unbonded interface. The use of two transducers, a pulse generator, and a CRT monitor are required. It cannot be used for extrusion fillet seams, because of their nonuniform thickness. The *ultrasonic impedance plane* method works on the principle of acoustic impedance. A continuous wave of 160 to 185 kHz is sent through the seamed geomembrane, and a characteristic dot pattern is displayed on a CRT screen. Calibration of the dot

pattern is required to signify a good seam; otherwise, it is not. The method has potential for all types of geomembranes but still needs additional developmental work. The *ultrasonic shadow method* uses two roller transducers: one sends a signal into the upper geomembrane and the other receives the signal from the lower geomembrane on the other side of the seam (Richardson and Koerner, 1988). The technique can be used for all types of seams, even those in difficult locations, such as around manholes, sumps, appurtenances, etc. It is best suited for semicrystalline geomembranes, including HDPE, and will not work for scrim-reinforced liners.

3.6.3 Recommendations for Various Seam Types

The various NDT methods listed in Table 3.5 have certain uniqueness and applicability to specific seam and geomembrane types. Thus a specification should only be framed around the particular seam type and geomembrane type for which it has been developed. Table 3.6 gives guidance in this regard. Even within Table 3.6, there are certain historical developments. For example, the air lance method is used routinely on the flexible geomembranes seamed by chemical methods, whereas the vacuum chamber method is used routinely on the relatively stiff HDPE geomembranes. Also to be noted is that the dual seam can technically be used on all geomembranes, but only when they are seamed by a dual track thermal fusion method, i.e., by hot wedge or hot air seaming methods. Thus by requiring such a dual seam pressure test method one mandates the type of seam which is to be used by the installation contractor.

Lastly, it should be mentioned that only three of the nine methods listed in Table 3.5 are used routinely at this point in time. They are the air lance, dual seam and vacuum chamber methods. The others are either uniquely used by the installation contractor (pick test and electric wire), or are in the research and development stage (electric current and the various ultrasonic test methods).

3.6.4 General Specification Items

Regarding field evaluation of geomembrane seams and their nondestructive testing, a specification or CQA document should consider the following items:

1. The purpose of nondestructive testing should be clearly stated. For example, nondestructive testing is meant to verify the continuity of field seams and not to quantify seam strength.
2. Generally nondestructive testing is conducted as the seaming work progresses or as soon as a suitable length of seam is available.
3. Generally nondestructive testing of some type is required for 100% of the field seams. For geomembranes supplied in factory fabricated panels, the factory seams may, or may not, be specified to be nondestructively tested in the field. This decision depends on the degree of MQC (and MQA) required on factory fabricated seams.
4. The specification should recognize that the same type of nondestructive test cannot be used in every location. For example, in sumps and at pipe penetrations the dual air channel and vacuum box methods may not be usable.
5. It must be recognized that there are no current ASTM Standards on any of the NDT methods presented in Table 3.5 although many are in progress. Thus referencing to such consensus documents is not possible. For temporary guidance, there is a GRI Standard available for dual seam air pressure test method, GRI GM-6.

6. CQA personnel should observe all nondestructive testing procedures.
7. The location, data, test number, name of test person and outcome of tests must be recorded.
8. The Owner's representative should be informed of any deficiencies.
9. The method of repair of deficiencies found by nondestructive testing should be clearly outlined in the specifications or CQA documents, as should the retesting procedure.

Table 3.6 Applicability Of Various Nondestructive Test Methods To Different Seam Types And Geomembrane Types

| NDT Method | Seam Types* | Geomembrane Types |
|----------------------------|--------------------------------------|-------------------|
| 1. air lance | C, BC, Chem A, Cont. A | all except HDPE |
| 2. mechanical point stress | all | all |
| 3. dual seam | HW, HA | all |
| 4. vacuum chamber | all | all |
| 5. electric wire | all | all |
| 6. electric current | all | all |
| 7. ultrasonic pulse echo | HW, HA C, BC, Chem. A, Cont. A | HDPE, VLDPE, PVC |
| 8. ultrasonic impedance | HW, HA C, BC, Chem. A, Cont. A | HDPE, VLDPE, PVC |
| 9. ultrasonic shadow | E Fil., E Flt., HW, HA | HDPE, VLDPE |

*E Fil. = extrusion fillet
 E Flt. = extrusion flat
 HW = hot wedge
 HA = hot air
 C = chemical
 BC = bodied chemical
 Chem. A = chemical adhesive
 Cont. A = contact adhesive

3.7 Protection and Backfilling

The field deployed and seamed geomembrane must be backfilled with soil or covered with a subsequent layer of geosynthetics in a timely manner after its acceptance by the CQA personnel. If the covering layer is soil, it will generally be a drainage material like sand or gravel depending upon the required permeability of the overlying layer. Depending upon the particle size, hardness and angularity of this soil, a geotextile or other type of protection layer may be necessary. If the covering layer is a geosynthetic, it will generally be a geonet or geocomposite drain, which is usually placed directly upon the geomembrane. This is obviously a critical step since geomembranes are relatively thin materials with puncture and tear strengths of finite proportions. Specifications should be very clear and unequivocal regarding this final step in the installation survivability of geomembranes.

3.7.1 Soil Backfilling of Geomembranes

There are at least three important considerations concerning soil backfilling of geomembranes: type of soil backfill material, type of placement equipment and considerations of slack in the geomembrane.

Concerning the type of soil backfilling material; its particle size characteristics, hardness and angularity are important with regard to the puncture and tear resistance of the geomembrane. In general, the maximum soil particle size is very important, with additional concerns over poorly graded soils, increased angularity and increased hardness being of significance. Past research on puncture resistance of geomembranes has shown that HDPE and CSPE-R geomembranes are more sensitive to puncture than are VLDPE and PVC geomembranes for conventional thicknesses of the respective types of geomembranes. Using truncated cones in laboratory tests to simulate the puncturing phenomenon (Hullings and Koerner, 1991), the critical cone height values which were obtained are listed in Table 3.7. It should be cautioned, however, that these values are not based on actual soil subgrades, nor on geostatic type stresses. The values are meant to give relative performance between the different geomembrane types.

Table 3.7. Critical Cone Heights For Selected Geomembranes In Simulated Laboratory Puncture Studies (Richardson and Koerner, 1988)

| Geomembrane Type | Geomembrane Thickness | | Critical Cone Height | |
|------------------|-----------------------|-----|----------------------|------|
| | mm | mil | mm | inch |
| HDPE | 1.5 | 60 | 12 | 0.50 |
| VLDPE | 1.0 | 40 | 89 | 3.50 |
| PVC | 0.5 | 20 | 70 | 2.75 |
| CSPE-R | 0.9 | 36 | 15 | 0.60 |

Although the truncated cone hydrostatic test is an extremely challenging index-type test, the data of Table 3.7 does not reflect creep and/or stress relaxation of the geomembrane. In reviewing numerous CQA documents it appears that the maximum backfill particle size for use with HDPE and CSPE-R geomembranes should not exceed 12-25 mm (0.5-1.0 in.). VLDPE and PVC geomembranes appear to be able to accommodate larger soil backfill particle sizes. If the soil

particle size must exceed the approximate limits given (e.g., for reasons of providing high permeability in a drainage layer), then a protection material must be placed on top of the geomembrane and beneath the soil. Geotextiles, as well as other protection materials, have been used in this regard. New materials, e.g., recycled fiber geotextiles and rubber matting, are being evaluated.

Concerning the type of placement equipment, the initial lift height of the backfill soil is very important. (Note that construction equipment should never be allowed to move directly on any deployed geomembrane. This includes rubber tired vehicles such as automobiles and pickup trucks but does not include light weight equipment like all-terrain vehicles (ATV's). The minimum initial lift height should be determined for the type of placement equipment and soil under consideration, however, 150 mm (6 in.) is usually considered to be a minimum. Between this value and approximately 300 mm (12.0 in.), low ground pressure placement equipment should be specified. Ground contact pressure equipment of less than 35 kPa (5.0 lb/in²) is recommended. For lift heights of greater than 300 mm (12.0 in.), proportionately heavier placement equipment can be used.

Placement of soil backfilling should proceed from a stable working area adjacent to the deployed geomembrane and gradually progress outward. Soil is never to be dropped from dump trucks or front end loaders directly onto the geomembrane. The soil should be pushed forward in an upward tumbling action so as not to impact directly on the geomembrane. It should be placed by a bulldozer or front end loader, never by a motor grader which would necessarily have its front wheels riding directly on the geomembrane. Sometimes "fingers" of backfill are pushed out over the geomembrane with controlled amounts of slack between them. Figure 3.26 shows a sketch and photograph of this type of soil covering placement. Backfill is then widened so as to connect the "fingers", with the controlled slack being induced into the geomembrane. This procedure is at the discretion of the design engineer and depends on site specific materials and conditions.

If a predetermined amount of slack is to be placed in the geomembrane, the temperature of the geomembrane itself during backfilling is important and should be contrasted against the minimum service temperature that the geomembrane will eventually experience. This difference in temperature, assuming the geomembrane temperature at the time of backfilling is higher than the minimum service temperature, is multiplied by the distance between backfilling "fingers" and by the coefficient of thermal expansion/contraction of the particular geomembrane. Coefficients of thermal expansion/contraction found in the literature are given in Table 3.8. Note, however, that the coefficient of expansion/contraction of the site specific geomembrane should be available for such calculations.

While many geomembrane polymers fall in the same general range of coefficient of thermal expansion/contraction (as seen in Table 3.8), it is the stiff and relatively thick geomembranes, which are troublesome during backfilling. Here the slack accumulates in a wave which should not be allowed to crest over on itself, lest a fold is trapped beneath the backfill. In such cases, the "fingers" of backfilling must be relatively close together. If the situation becomes unwieldy due to very high geomembrane temperature, the backfilling should temporarily cease until the ambient temperature decreases. This will have the effect of requiring less slack to be placed in the geomembrane.

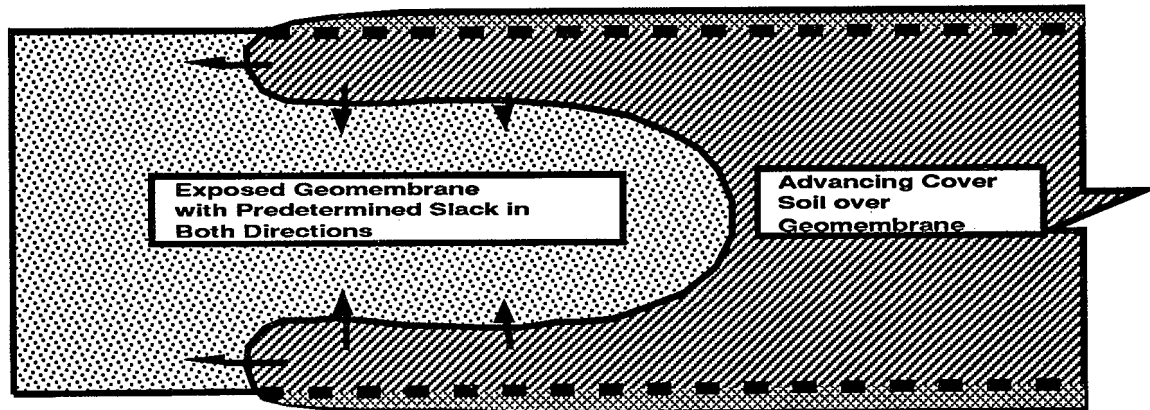

Note: Arrows Indicate Advancement of Cover Soil Over Geomembrane

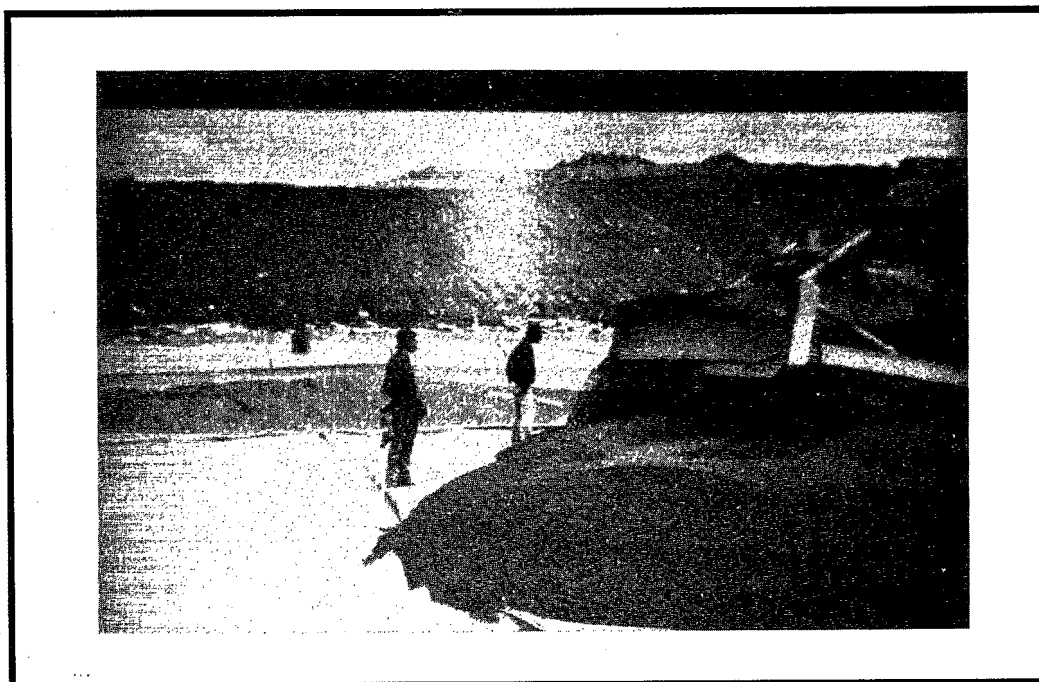

Figure 3.26 - Advancing Primary Leachate Collection Gravel in “Fingers” Over the Deployed Geomembrane

Table 3.8 - Coefficients Of Thermal Expansion/Contraction Of Various Nonreinforced Geomembrane Polymers (Various References)*

| Polymer Type | Thermal linear expansivity x 10 ⁻⁵ | |
|--------------------|---|---------|
| | per 1°F | per 1°C |
| Polyethylene | | |
| high density | 7-12 | 12-22 |
| medium density | 6-8 | 11-15 |
| low density | 5-7 | 9-13 |
| very low density | 11-16 | 20-30 |
| Polypropylene | 3-5 | 5-9 |
| Polyvinyl chloride | | |
| unplasticized | 3-10 | 5-18 |
| plasticized | 4-14 | 7-25 |

*Values are approximate and change somewhat with the particular formulation and with the actual temperature range over which the values are measured.

3.7.2 Geosynthetic Covering of Geomembranes

Various geosynthetic materials may be called upon to cover the deployed and seamed geomembrane. Often a geotextile or a geonet will be the covering material. Sometimes, however, it will be a geogrid (for cover soil reinforcement on slopes) or even a drainage geocomposite (again on slopes to avoid instability of natural drainage soils). As with the previous discussion on soil covering, no construction vehicles of any type should be allowed to move directly on the geomembrane (or any other geosynthetic for that matter). Generators, low tire inflation ATV's, and other seaming related equipment are allowed as long as they do not damage the geomembrane. As a result, the movement of large rolls of geotextile or geonet becomes very labor intensive. Proper planning and sequencing of the operations is important for logistical control. The geosynthetic materials are laid directly on the geomembrane with no bonding of any type to the geomembrane being allowed. For example, thermally fusing of a geonet to a geomembrane should not be permitted. Temperature compensation (as described earlier) should be added based on material characteristics.

The geosynthetics placed above the geomembrane will either be overlapped (as with some geotextiles), sewn (as with other geotextiles), connected with plastic ties (as with geonets), mechanically joined with rods or bars (as with geogrids), or male/female joined (as with drainage composites). These details will be described in Chapter 6 on geosynthetic materials other than geomembranes.

3.7.3 General Specification Items

The specification or CQA document for backfilling should be written around the concept that the geomembrane must be protected against damage by the overlying material. Since soil, usually sand or gravel, is the most common backfilling material, the items that follow should be considered.

1. The temperature during soil backfilling should be considered. Expansion, contraction, puncture, tear and other properties vary in accordance with the geomembrane temperature.
2. In general, backfilling in warm climates or during summer months should be performed at the coolest part of the day.
3. In extreme cases of excessively high temperatures, backfilling may be required during non-typical work hours, e.g., sunrise to 10:00 AM or 5:00 PM to sunset.
4. If soil backfilling is to be done between sunset and sunrise, i.e., at night, the work area should be suitably lit for safety, constructability and inspection considerations.
5. If soil backfilling is to be done at night, excessive equipment noise may not be tolerated by people in the local neighborhood. This is an important and obviously site specific condition which should be properly addressed.
6. When a geotextile or other protection layer is to be placed above the geomembrane it should be done so according to the plans and specifications.
7. Soil placement equipment should never move, or drive, directly on the geomembrane.
8. Personnel or materials vehicles (automobiles, pickup trucks, etc.) should never drive directly on the geomembrane.
9. The soil particle size characteristics should be stipulated as part of the design requirements.
10. The minimum soil lift thickness should be stipulated in the design requirements. Furthermore, the thickness should be clear as to whether it is loose or compacted thickness.
11. The maximum ground contact pressure of the placement equipment should be stipulated in the design requirements.
12. For areas regularly traversed by heavy equipment, e.g., the access route for loaded dump trucks, a larger than usual fill height should be required.
13. The CQA personnel should be available at all times during backfilling of the geomembrane. It is the last time when anyone will see the completely installed material.
14. Documentation should include the soil type, lift thickness, total thickness, density and moisture conditions (as appropriate).

3.8 References

- ASTM D-413, "Rubber Property-Adhesion to Flexible Substrate"
- ASTM D-638, "Tensile Properties of Plastics"
- ASTM D-751, "Test Methods for Coated Fabrics"
- ASTM D-792, "Specific Gravity and Density of Plastics by Displacement"
- ASTM D-882, "Test Methods for Tensile Properties of Thin Plastic Sheeting"
- ASTM D-1004, "Initial Tear Resistance of Plastic Film and Sheeting"
- ASTM D-1238, "Flow Rates of Thermoplastics by Extrusion Plastometer"
- ASTM D-1248, "Polyethylene Plastics and Extrusion Materials"
- ASTM D-1505, "Density of Plastics by the Density-Gradient Technique"
- ASTM D-1603, "Carbon Black in Olefin Plastics"
- ASTM D-1765, "Classification System for Carbon Black Used in Rubber Products"
- ASTM D-2663, "Rubber Compounds - Dispersion of Carbon Black"
- ASTM D-3015, "Recommended Practice for Microscopical Examination of Pigment Dispersion in Plastic Compounds"
- ASTM D-3083, "Specification for Flexible Poly (Vinyl Chloride) Plastic Sheeting for Pond, Canal, and Reservoir Lining"
- ASTM D-4437, "Practice for Determining the Integrity of Field Seams Used in Joining Flexible Polymeric Sheet Geomembranes"
- ASTM D-4545, "Practice for Determining the Integrity of Factory Seams Used in Joining Manufactured Flexible Sheet Geomembranes"
- ASTM D-4759, "Determining the Specification Conformance of Geosynthetics"
- ASTM D-5046, "Specification for Fully Crosslinked Elastomeric Alloys"
- ASTM D-5199, "Measuring Nominal Thickness of Geotextiles and Geomembranes"
- ASTM D-5321 "Determining the Coefficient of Soil and Geosynthetic or Geosynthetic and Geosynthetic Friction by the Direct Shear Method"
- ASTM D-5397, "Notched Constant Tensile Load Test for Polyolefin Geomembranes"

- FTM Std. 101C, "Puncture Resistance and Elongation Test," Federal Test Method 2065," March 13, 1980.
- GRI GM-6, "Pressurized Air Channel Test for Dual Seamed Geomembranes"
- GRI GM-7, "Accelerated Curing of Geomembrane Test Strips Made by Chemical Fusion Methods"
- GRI GS-7, "Determining the Index Friction Properties of Geosynthetics"
- Haxo, H. E., (1988), "Lining of Waste Containment and Other Impoundment Facilities," EPA/600/2-88/052, Washington, DC.
- Hsuan, Y. and Koerner, R. M. (1992), "Stress Cracking Potential and Behavior of HDPE Geomembranes," Final Report to U.S. EPA, Contract No. CR-815692.
- Hullings, D. E. and Koerner, R. M. (1991), "Puncture Resistance of Geomembranes Using a Truncated Cone Test," *Proceedings*, Geosynthetics '91, IFAI, pp. 273-286.
- Richardson, G. N. and Koerner, R. M. (1988), "Geosynthetic Design Guidance for Hazardous Waste Landfill Cells and Surface Impoundments," EPA/600/S2-87/097.
- Richardson, G. N. (1992), "Construction Quality Management for Remedial Action and Remedial Design Waste Containment Systems," U.S. EPA, EPA/540/R-92/073, Washington, DC.
- U. S. Environmental Protection Agency (1991) "Inspection Techniques for the Fabrication of Geomembrane Field Seams," EPA Technical Guidance Document, EPA/530/SW-91/051.

Chapter 4

Geosynthetic Clay Liners

4.1 Types and Composition of Geosynthetic Clay Liners

As with most types of manufactured products within a given category, there are sufficient differences such that no two products are truly equal to one another. Geosynthetic clay liners (GCLs) are no exception. Yet, there are a sufficient number of common characteristics such that the current commercially available products deserve a separate category and a separate treatment in this manual. GCLs can be defined as follows:

“Geosynthetic clay liners (GCLs) are factory manufactured, hydraulic barriers typically consisting of bentonite clay or other very low permeability clay materials, supported by geotextiles and/or geomembranes which are held together by needling, stitching and/or chemical adhesives”

Other names that GCLs have been listed under, are “clay blankets”, “clay mats”, “bentonite blankets”, “bentonite mats”, “prefabricated bentonite clay blankets”, etc. GCLs are hydraulic barriers to water, leachate or other liquids. As such, they are used to augment or replace compacted clay liners or geomembranes, or they are used in a composite manner to augment the more traditional clay liner or geomembrane materials.

Cross section sketches of the currently available GCLs at the time of writing are shown in Fig. 4.1. General comments regarding each type follow:

- Figure 4.1(a) illustrates a bentonite clay mixed with a water soluble adhesive which is supported by individual geotextiles on both its upper and lower surfaces.
- Figure 4.1(b) illustrates a stitchbonded variation of the above type of product whereby the upper and lower geotextiles are joined by continuous sewing in discrete rows throughout the machine direction of the product as well as a recent product which consists of bentonite powder alone with no admixed adhesive.
- Figure 4.1(c) illustrates a bentonite clay powder or granules, containing no adhesive, which is supported by individual geotextiles on its upper and lower surfaces and is needle punched throughout to provide for its stability. Several variations of this type of GCL are available including styles with clay infilled in the voids of the upper geotextile.
- Figure 4.1(d) illustrates a bentonite clay which is admixed with an adhesive and is supported by a geomembrane on its lower surface, as shown, or it can be used in an inverted manner with the geomembrane side facing upward. Variations of this product are also available with textured or raised geomembrane surfaces.

All of the GCL products available in North America use sodium bentonite clay (predominately smectite) powder or granules at as-manufactured mass per unit areas in the range of 3.2 to 6.0 kg/m² (0.66 to 1.2 lb/ft²). The clay thickness in the various products vary between the range of 4.0 to 6.0 mm (160 to 320 mils). GCLs are delivered to the job site at moisture contents which

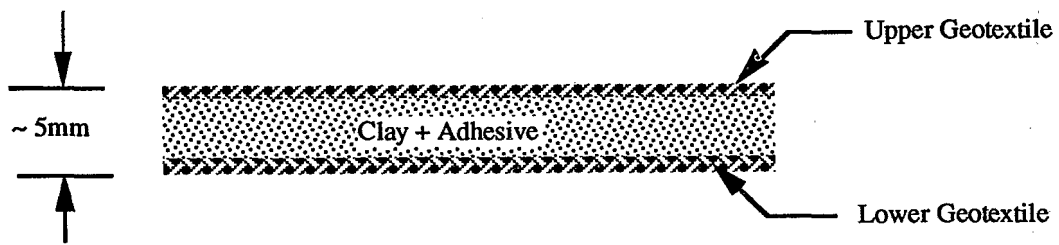

(a) Adhesive Bound Clay to Upper and Lower Geotextiles

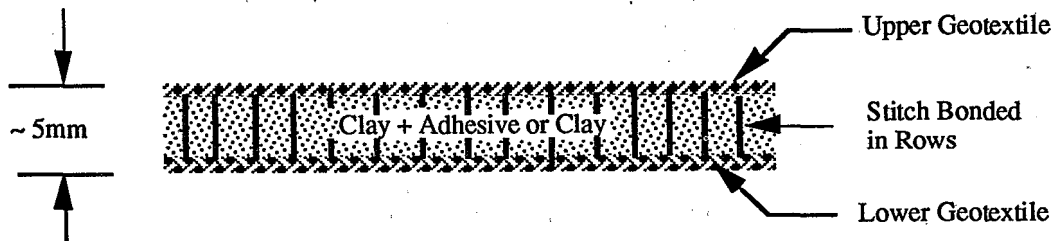

(b) Stitch Bonded Clay Between Upper and Lower Geotextiles

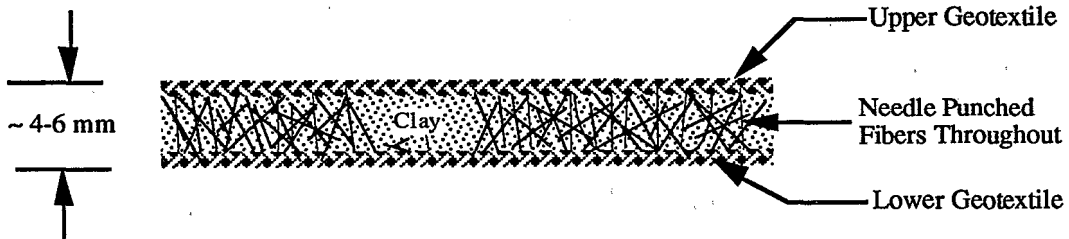

(c) Needle Punched Clay Through Upper and Lower Geotextiles

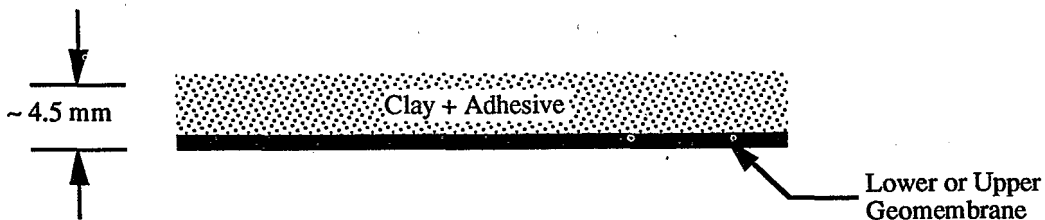

(d) Adhesive Bound Clay to a Geomembrane

Figure 4.1 - Cross Section Sketches of Currently Available Geosynthetic Clay Liners (GCLs)

vary from 5 to 23%, depending upon the local humidity. Note that this is sometimes referred to in the technical literature as the "dry" state. The types of geotextiles used with the different products vary widely in their manufacturing style (e.g., woven slit film, needle punched nonwoven, spunlaced, heat bonded nonwovens, etc.) and in their mass per unit area [e.g., varying from 85 g/m² (2.5 oz/yd²) to 1000 g/m² (30 oz/yd²)]. The particular product with a geomembrane backing can also vary in its type, thickness and surface texture.

GCLs are factory made in widths of 2.2 to 5.2 m (7 to 17 ft) and lengths of 30 to 61 m (100 to 200 ft). Upon manufacturing GCLs are rolled onto a core and are covered with a plastic film to prevent additional moisture gain during storage, transportation, and placement prior to their final covering with an overlying layer.

4.2 Manufacturing

This section on manufacturing of GCLs will discuss the various raw materials, manufacturing of the rolls, and covering of the rolls.

4.2.1 Raw Materials

The bentonite clay materials currently used in the manufacture of GCLs are all of the sodium montmorillonite variety which is a naturally occurring mineral in the Wyoming and North Dakota regions of the USA. After the clay is mined, it is dried, pulverized, sieved and stored in silos until it is transported to a GCL manufacturing facility.

The other raw material ingredient used in the manufacture of certain GCLs (recall Section 4.1) is an adhesive which is a proprietary product among the two manufacturers that produce this type of GCL. Additionally, geotextiles and/or geomembranes are used as substrate (below the clay) or superstrate (above the clay) layers which are product specific as was mentioned in the previous section.

Regarding a specification or MQA document for the various raw materials used in the manufacture of GCLs, the following items should be considered.

1. The clay should meet the GCL manufacturer's specification for quality control purposes. This is often 70% to 90% sodium montmorillonite clay from the Wyoming/North Dakota "Black Hills" region of bentonite deposits. A certificate of analysis should be submitted by the vendor for each lot of clay supplied. While the situation is far from established, the certificate may include the various compounds of the clay, per X-Ray diffraction or methylene-blue absorption, particle size per ASTM D-422 or C-136, moisture content per ASTM D-2216 or D-4643, bulk density per ASTM B-417, and free swell.
2. The GCL manufacturer should have a MQC plan which describes the procedures for accomplishing quality in the final product, various tests to be conducted and their frequency. This MQC document should be fully implemented and followed.
3. The MQC test methods that the GCL manufacturer performs on the clay component may include the following; free swell per USP-NF-XVIII or ASTM draft standard, "Determination of Volumetric Free Swell of Powdered Bentonite Clay," plate water absorption per ASTM E-946, moisture content per ASTM D-2216 or D-4643 and (sometimes) particle size per ASTM D-422, fluid loss per API 13B, pH per ASTM D-4972, and liquid/plastic limit per ASTM D-4318.

4. For those products which use adhesives, the composition of the proprietary adhesive is rarely specified. If a statement is required, it should signify that the adhesive selected has been successfully used in the past and to what extent.
5. The geotextiles used as the substrate or the superstrate, or the geomembrane vary according to the particular style of product. Manufacturers current literature should be used in this regard. If a statement is required it should signify that the products selected have been successfully used in the past and to what extent.
6. If further detail is needed as to a specification for the geotextiles, see Chapter 6. Similarly, specifications for geomembranes are found in Chapter 3.
7. The type of sewing thread (or yarn) which is used in joining the products is rarely specified. If a statement is required it should signify that the materials selected have been successfully used in the past and to what extent.

4.2.2 Manufacturing

The raw materials just described are used to make the final GCL product. The production facilities are all relatively large operations where the products are made in a continuous manner. Process quality control is obviously necessary and is practiced by all GCL manufacturers. Figure 4.2 illustrates, in schematic form, the various processing methods used for those GCLs which have adhesives mixed with the clay and those which are stitch bonded and needle punched. Figure 4.2(a) illustrates an adhesively bonded clay product which has an adhesive sprayed in a number of layers with intermittent additions of bentonite. The clay is placed either between geotextiles or on a geomembrane. Figure 4.2(b) illustrates the needle punching or stitch bonding of a bentonite clay powder after it is placed between the covering geotextiles. Windup around a core and placement of the protective covering is common among all GCLs.

There are numerous items which should be included in a specification or MQA document focused on the manufactured GCL product.

1. There should be verification that the actual geotextiles or geomembrane used meet the manufacturer's specification for that particular type and style.
2. A statement should be included that the geotextile property values are based on the minimum average roll value (MARV) concept. The geomembrane's properties are generally based on average values.
3. Verification that needle punched nonwoven geotextiles have been inspected continuously for the presence of broken needles using an in-line metal detector. There should also be a magnet, or other device, for removal of broken needles.
4. Verification that the proper mass per unit area of bentonite clay has been added to the product should be provided. At a minimum, this should consist of providing a calculated value based on the net weight of the final roll divided by its area (with deduction for the mass per unit area of the geosynthetics and the adhesive, if any).
5. Thickness measurements are product dependent, i.e., some GCLs can be quality controlled via thickness while others cannot.

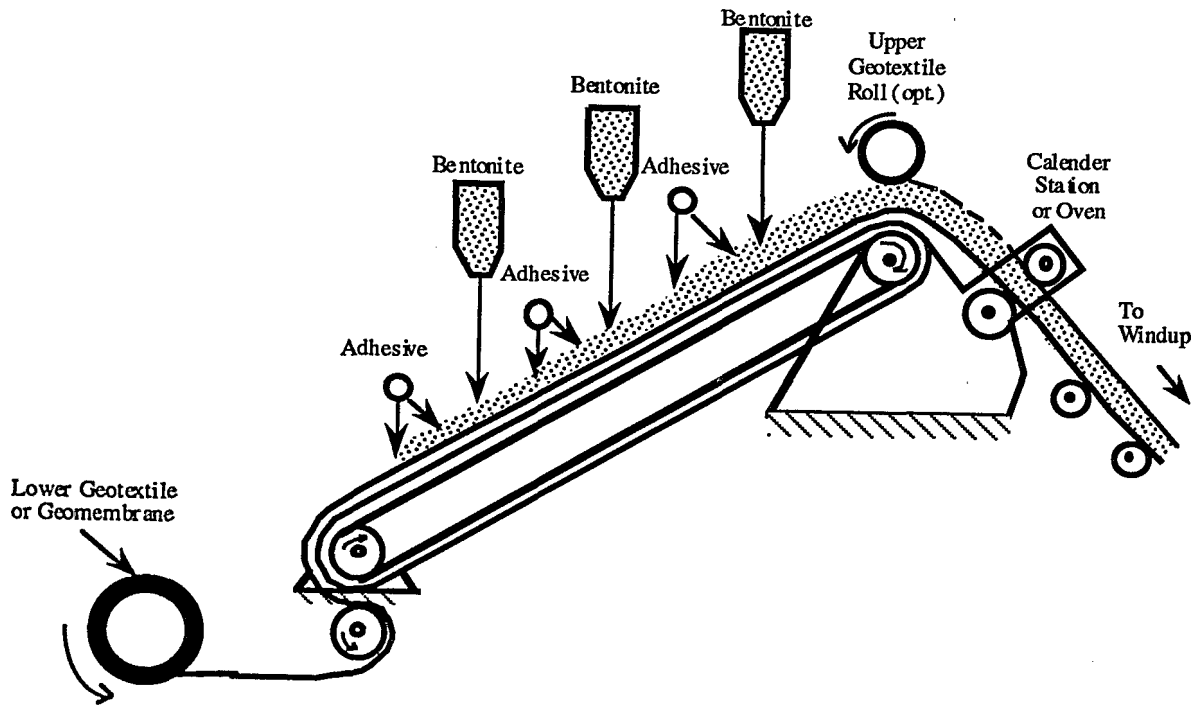

(a) Adhesive Mixed with Clay

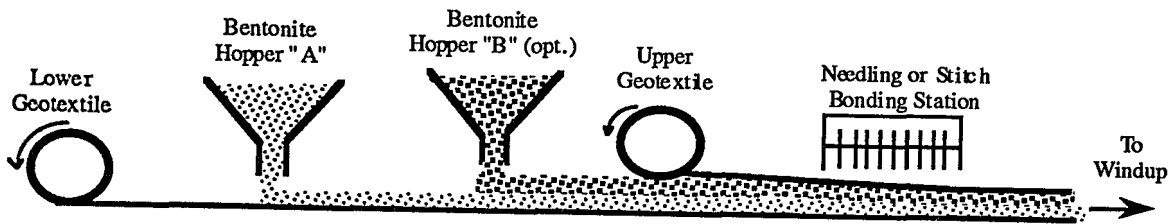

(b) Needle Punched or Stitch Bonded Through Clay

Figure 4.2 - Schematic Diagrams of the Manufacture of Different Types of Geosynthetic Clay Liners (GCLs)

6. It is recommended that the overlap distance on both sides of the GCL be marked with two continuous waterproof lines guiding the minimum overlap distances.
7. The product should be wrapped around a core which is structurally sound such that it can support the weight of the roll without excessive bending or buckling under normal handling conditions as recommended by the manufacturer.
8. The GCL manufacturer should have a MQC plan for the finished product, which includes sampling frequency, and it should be implemented and followed.
9. The manufacturer's quality control tests on the finished product should be stipulated and followed. Typical tests include thickness per ASTM D-1777 or ASTM D-5199, total product mass per unit area per ASTM D-5261, clay content mass per unit area per ASTM D-5261, hydraulic conductivity (permeability) per ASTM D-5084 or GRI GCL2 and sometimes shear strength at various locations such as top, mid-plane and bottom per ASTM D-5321. Other tests as recommended by the manufacturer are also acceptable.

4.2.3 Covering of the Rolls

The final step in the manufacturing of GCLs is their covering with a waterproof, tightly-fit, plastic covering. This covering is sometimes a spirally wound polyethylene film approximately 0.05 to 0.08 mm (2 to 5 mils) thick and is the final step in production. The covering can also be a plastic bag, or sheet, pulled over the product as a secondary operation. Figure 4.3 shows the factory storage of GCLs, with their protective covering, before shipment to the field.

Some items for a specification or MQA document with regard to the covering of GCLs are the following:

1. The manufacturer should clearly stipulate the type of protective covering and the manner of cover placement. The covering should be verified as to its capability for safe storage and proper transportation of the product.
2. The covering should be placed around the GCL in a workmanlike manner so as to effectively protect the product on all of its exposed surfaces and edges.
3. The central core should be accessible for handling by fork lift vehicles fitted with a long pole (i.e., a "stinger") attached. For wide GCLs, e.g., wider than approximately 3.5 m (11.5 ft), handling should be by overhead cranes utilizing two dedicated slings provided on each roll at approximately the one-third points.
4. Clearly visible labels should identify the name and address of the manufacturer, trademark, date of manufacture, location of manufacture, style, roll number, lot number, serial number, dimensions, weight and other important items for proper identification. Refer to ASTM D-4873 for proper labeling in this regard. In some cases, the roll number itself is adequate to trace the entire MQC record and documentation.

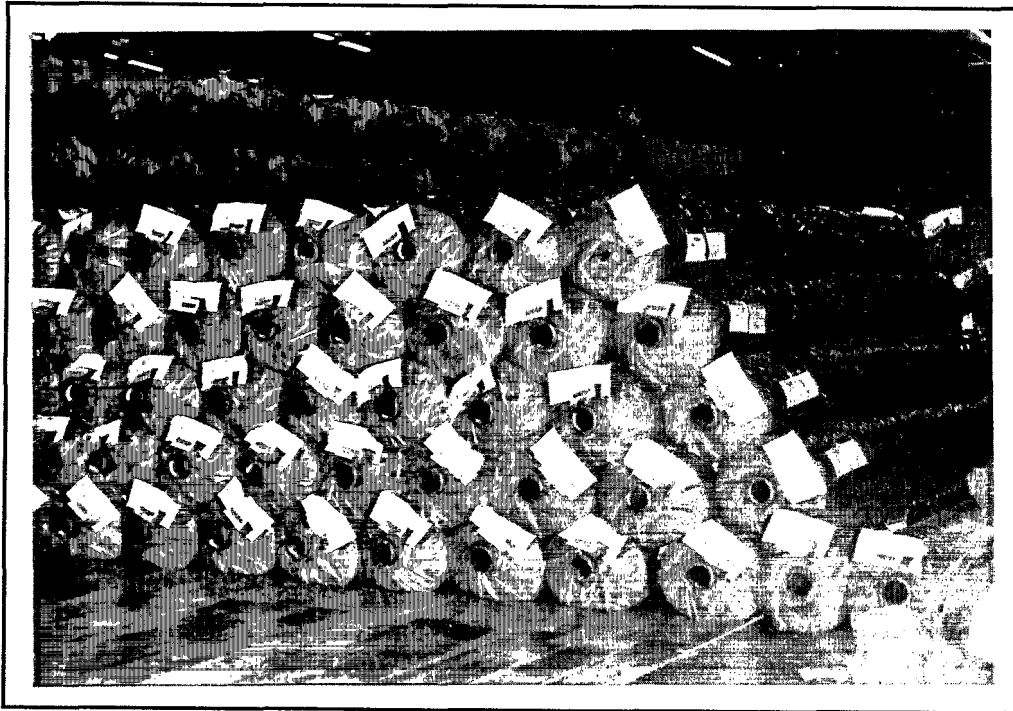

Figure 4.3 - Indoor Factory Storage of Geosynthetic Clay Liners (GCLs) Waiting for Shipment to a Job Site

4.3 Handling

A number of activities occur between the manufacture of a GCL, its final positioning in the field and subsequent backfilling. Topics such as storage at the factory, transportation, storage at the site and acceptance/conformance testing will be described in this section.

4.3.1 Storage at the Manufacturing Facility

Storage of GCLs at the manufacturers facility is common. Storage times typically range from days to six months. Figure 4.3 illustrated typical GCL storage at a fabrication facility.

Some specifications or MQA items to consider for storage and handling of GCLs are the following:

1. GCLs should always be stored indoors until they are ready to be transported to the field site.
2. Handling of the GCLs should be such that the protective wrapping is not damaged. If it is, it must be immediately rewrapped by machine or by hand. In the case of minor tears it may be taped.

3. Placement and stacking of rolls should be done in a manner so as to prevent thinning of the product at the points of contact with the storage frame or with one another. Storage in individually supported racks is common so as to more efficiently use floor space.

4.3.2 Shipment

Rolls of GCLs are shipped from the manufacturers storage facility to the job site via common carrier. Ships, railroads and trucks have all been used depending upon the locations of the origin and final destination. The usual carrier within the USA is truck, which should be with the GCLs contained in an enclosed trailer as shown in Fig. 4.4(a), or on an open flat-bed trailer which is tarpaulin covered as shown in Fig. 4.4(b). Some manufacturers have their own dedicated fleet of trucks. The rolls are sometimes handled by fork lift with a stinger attached. The “stinger” is a long tapered rod which fits inside the core upon which the GCL is wrapped, see Fig. 4.4(a). Alternatively, rolls can be handled using the two captive slings provided on each roll.

Insofar as a specification or MQA document is concerned, a few items should be considered.

1. The GCLs should be shipped by themselves with no other cargo which could damage them in transit, during stops, or while offloading other materials.
2. The method of loading the GCL rolls, transporting them and offloading them at the job site should not cause any damage to the GCL, its core, nor its protective wrapping.
3. Any protective wrapping that is damaged or stripped off of the rolls should be repaired immediately or the roll should be moved to a enclosed facility until its repair can be made to the approval of the quality assurance personnel.
4. If any of the clay has been lost during transportation or from damage of any type, the outer layers of GCL should be discarded until undamaged product is evidenced. The remaining roll must be rewrapped in accordance with the manufacturer’s original method to prevent hydration or further damage to the remaining roll.

4.3.3 Storage at the Site

Storage of GCLs at the field site is cautioned due to the potential for moisture pickup (even through the plastic covering) or accidental damage. The concept of “just-in-time-delivery” can be used for GCLs transported from the factory to the field. When storage is required for a short period of time i.e., days or a few weeks, and the product is delivered in trailers, the trailers can be unhitched from their tractors and used as temporary storage. See the photograph of Fig. 4.5(a). Alternatively, storage at the job site can also be acceptable if the GCLs are properly positioned, protected and maintained, see Fig. 4.5(b).

If storage of GCLs is permitted on the job site, offloading of the rolls should be done in an acceptable manner. Some specification or CQA* document items to consider are the following.

1. Handling of rolls of GCLs should be done in a competent manner such that damage does not occur to the product nor to its protective wrapping. In this regard ASTM D-4873, “Identification, Storage and Handling of Geotextiles”, should be referenced and followed.

* Note that the designations of MQC and MQA will now shift to CQC and CQA since field construction personnel are involved.



Figure 4.4(a) - Fork Lift Equipped with a “Stinger”

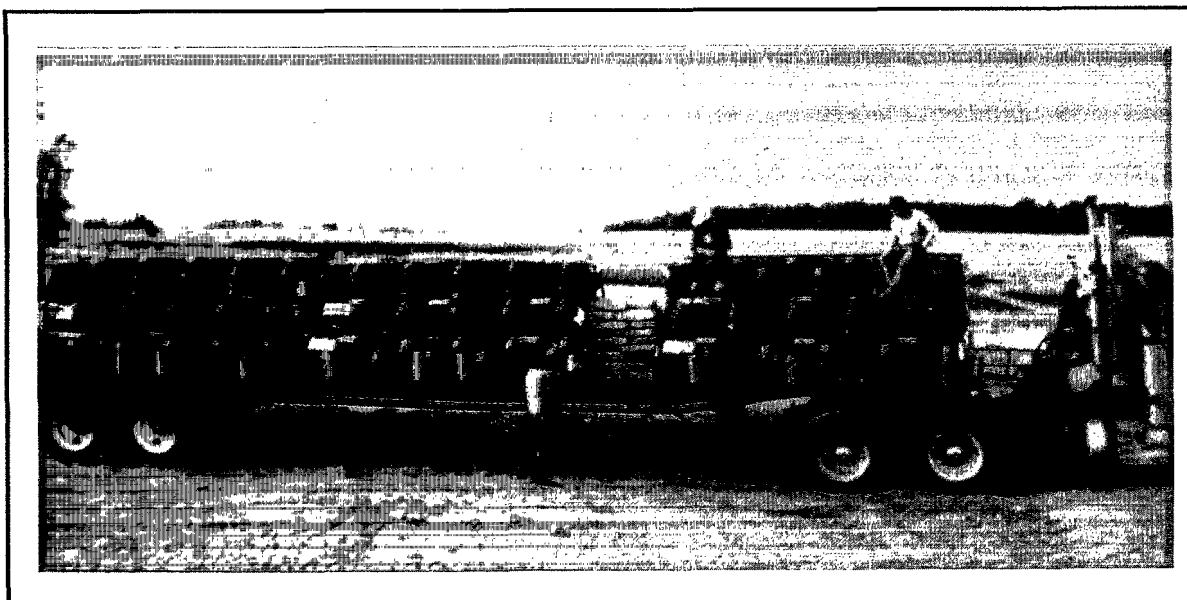

Figure 4.4(b) - GCL Rolls on a Flat-Bed Trailer



Figure 4.5(a) - Photograph of Temporary Storage of GCLs in their Shipping Trailers

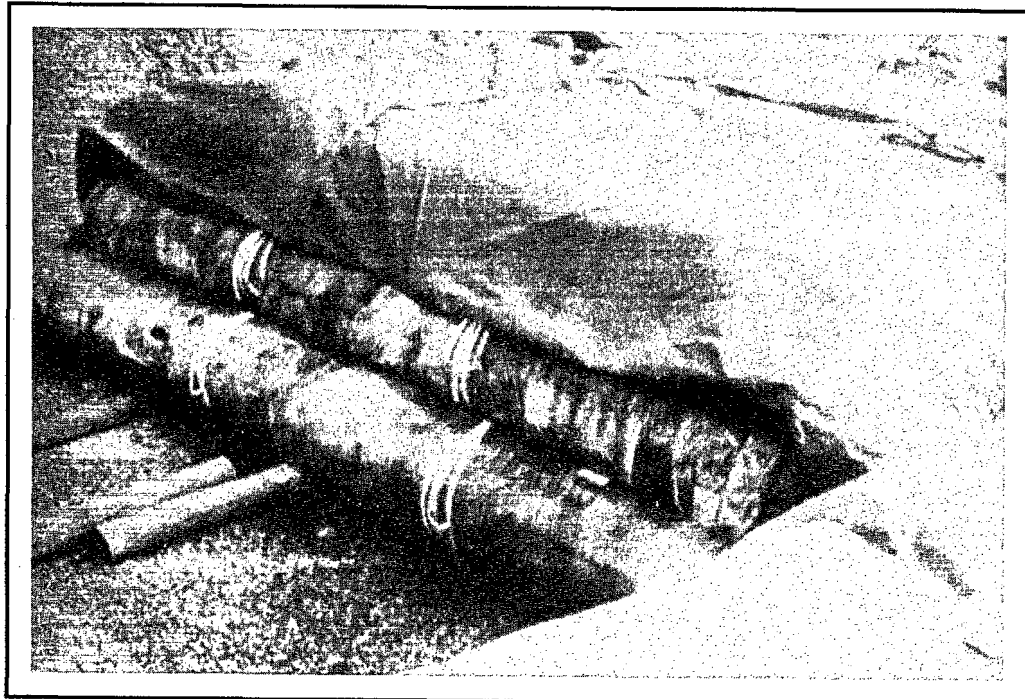

Figure 4.5(b) - Photograph of Temporary Storage of GCLs at Project Site

2. The location of temporary field storage should not be in areas where water can accumulate. The rolls should be stored on high flat ground or elevated off of the ground so as not to form a dam creating the ponding of water. It is recommended to construct a platform so that GCL rolls are continuously supported along their length.
3. The rolls should not be stacked so high as to cause thinning of the product at points of contact. Furthermore, they should be stacked in such a way that access for conformance testing is possible.
4. If outdoor storage of rolls is to be longer than a few weeks particular care, e.g., using tarpaulins, should be taken to minimize moisture pickup or accidental damage. For storage periods longer than one season a temporary enclosure should be placed over the rolls, or they should be moved within an enclosed facility.

4.3.4 Acceptance and Conformance Testing

Upon delivery of the GCLs to the field site, the CQA officer should see that conformance test samples are obtained. These samples are then sent to the CQA Laboratory for testing to ensure that the GCL conforms to the project plans and specifications. The samples are taken from selected rolls by removing the protective wrapping and cutting full-width, 1 m (3 ft.) long samples from the outer wrap of the selected roll(s). Sometimes one complete outer revolution of GCL is discarded before the test sample is taken. The rolls are immediately re-wrapped and replaced in the shipping trailers or in the temporary field storage area. Alternatively, conformance testing could be performed at the manufacturer's facility and when completed the particular lot should be identified for the particular project under investigation..

Items to consider for a specification or CQA document in this regard are the following:

1. The samples should be identified by type, style, lot and roll numbers. The machine direction should be noted on the sample(s) with a waterproof marker.
2. A lot is usually defined as a group of consecutively numbered rolls from the same manufacturing line. Other definitions are also possible and should be clearly stated in the CQA documents.
3. Sampling should be done according to the project specification and/or CQA documents. Unless otherwise stated, sampling should be based on a lot basis. Different interpretations of sampling frequency within a lot are based on total area or on number of rolls. For example, sampling could be based on 10,000 m² (100,000 ft²) of area or on use of ASTM D-4354 which is based on rolls.
4. Testing at the CQA laboratory may include mass per unit area per ASTM D-5261, and free swell of the clay component per GRI-GCL1. The sampling frequency for these index tests should be based on ASTM D-4354. Other conformance tests, which are more performance oriented, could be required by the project specifications but at a reduced frequency compared to the above mentioned index tests. Examples are hydraulic conductivity (permeability) ASTM D-5084 (mod.) or GRI GCL2 and direct shear testing per ASTM D-5321. The sampling frequency for these performance tests might be based on area, e.g., one test per 10,000 m² (100,000 ft²).

5. If testing of the geotextiles, or geomembrane, covering the GCLs is desired it should be done on the original rolls of the geotextiles, or geomembrane, before they are fabricated into the GCL product. Once fabricated their properties will change considerably due to the needling, stitching and/or gluing during manufacturing.
6. Peel testing of needle punched or stitch bonded GCLs should be done in accordance with ASTM D-413 (mod.). The sampling frequency is recommended to be one test per 2000 m² (20,000 ft²).
7. Conformance test results should be sent to the CQA engineer prior to installation of any GCL from the lot under review.
8. The CQA engineer should review the results and should report any nonconformance to the Owner/Operator's Project Manager.
9. The resolution of failing conformance tests must be clearly stipulated in the specifications or CQA documents. Statements should be based upon ASTM D-4759 entitled "Determining the Specification Conformance of Geosynthetics."

4.4 Installation

This section will cover the placement, joining, repairing and covering of GCLs.

4.4.1 Placement

The installation contractor should remove the protective wrapping from the rolls to be deployed only after the substrate layer (soil or other geosynthetic) in the field has been approved by CQA personnel. The specification and CQA documents should be written in such a manner as to ensure that the GCLs are not damaged in any way. A CQA inspector should be present at all times during the handling, placement and covering of GCLs. Figure 4.6(a) shows the typical placement of a GCL in the field on soil subgrade and Fig. 4.6(b) shows placement (without heavy equipment) on an underlying geosynthetic.

The following items should be considered for inclusion in a specification or CQA document.

1. The installer should take the necessary precautions to protect materials underlying the GCL. If the substrate is soil, construction equipment can be used to deploy the GCL providing excessive rutting is not created. Excessive rutting should be clearly defined and quantified. In some cases 25 mm (1.0 in.) is the maximum rut depth allowed. If the ground freezes, the depth of ruts should be further reduced to a specified value. If the substrate is a geosynthetic material, GCL deployment should be by hand, or by use of small jack lifts or light weight equipment on pneumatic tires having low ground contact pressure.
2. The minimum overlap distance which is specified should be verified. This is typically 150 to 300 mm (6 to 12 in.) depending upon the particular product and site conditions.



Figure 4.6(a) - Field Deployment of a GCL on a Soil Subgrade



Figure 4.6(b) - Field Deployment of a GCL on an Underlying Geosynthetic

3. Additional bentonite clay should be introduced into the overlap region with certain types of GCLs. There are typically those with needle punched nonwoven geotextiles on their surfaces. The clay is usually added by using a line spreader or line chalker with the bentonite clay in a dry state. Alternatively, a bentonite clay paste, in the mixture range of 4 to 6 parts water to 1 part of clay, can be extruded in the overlap region. Manufacturer's recommendations on type and quantity of clay to be added should be followed.
4. During placement, care must be taken not to entrap in or beneath the GCL, fugitive clay, stones, or sand that could damage a geomembrane, cause clogging of drains or filters, or hamper subsequent seaming of materials either beneath or above the GCL.
5. On side slopes, the GCL should be anchored at the top and then unrolled so as to keep the material free of wrinkles and folds.
6. Trimming of the GCL should be done with great care so that fugitive clay particles do not come in contact with drainage materials such as geonets, geocomposites or natural drainage materials.
7. The deployed GCL should be visually inspected to ensure that no potentially harmful objects are present, e.g., stones, cutting blades, small tools, sandbags, etc.

4.4.2 Joining

Joining of GCLs is generally accomplished by overlapping without sewing or other mechanical connections. The overlap distance requirements should be clearly stated. For all GCLs the required overlap distance should be marked on the underlying layer by a pair of continuous guidelines. The overlap distance is typically 150 to 300 mm (6 to 12 in.). For those GCLs, with needle punched nonwoven geotextiles on their surfaces, dry bentonite is generally placed in the overlapped region. If this is the case, utmost care should be given to avoid fugitive bentonite particles from coming into contact with leachate collection systems. Another variation, however, has been to extrude a moistened tube of bentonite into the overlapped region.

Items to consider for a specification or CQA document follow:

1. The amount of overlap for adjacent GCLs should be stated and adhered to in field placement of the materials.
2. The overlap distance is sometimes different for the roll ends versus the roll edges. The values should be stated and followed.
3. If dry or moistened bentonite clay (or other material) is to be placed in the overlapped region, the type and amount should be stated in accordance with the manufacturer's recommendations and/or design considerations. Index testing requirements for proper verification of the clay should be specified accordingly. Furthermore, the placement procedure should be clearly outlined so as to have enough material to make an adequately tight joint and yet not an excessive amount which could result in fugitive clay particles.

4.4.3 Repairs

For the geotextile-related GCLs, holes, tears or rips in the covering geotextiles made during

transportation, handling, placement or anytime before backfilling should be repaired by patching using a geotextile. If the bentonite component of the GCL is disturbed either by loss of material or by shifting, it should be covered using a full GCL patch of the same type of product.

Some relevant specification or CQA document items follow.

1. Any patch, used for repair of a tear or rip in the geotextile, should be done using the same type as the damaged geotextile or other approved geotextile by the CQA engineer.
2. The size of the geotextile patch must extend at least 30 cm (12 in.) beyond any portion of the damaged geotextile and be adhesive or heat bonded to the product to avoid shifting during backfilling with soil or covering with another geosynthetic.
3. If bentonite particles are lost from within the GCL or if the clay has shifted, the patch should consist of the full GCL product. It should extend at least 30 cm (12 in.) beyond the extent of the damage at all locations. For those GCLs requiring additional bentonite clay in overlap seaming, the similar procedure should be used for patching.
4. Particular care should be exercised in using a GCL patch since fugitive clay can be lost which can find its way into drainage materials or onto geomembranes in areas which eventually are to be seamed together.

4.5 Backfilling or Covering

The layer of material placed above the deployed GCL will be either soil or another geosynthetic. Soils will vary from compacted clay layers to coarse aggregate drainage layers. Geosynthetics will generally be geomembranes although other geosynthetics may also be used depending on the site specific design. The GCL should generally be covered before a rainfall or snow event occurs. The reason for covering with the adhesive bonded GCLs is that hydration before covering can cause changes in thickness as a result of uneven swelling or whenever compressive or shear loads are encountered. Hydration before covering may be less of a concern for the needled and stitch bonded types of GCLs, but migration of the fully hydrated clay in these products might also be possible under sustained compressive or shear loading. Figure 4.7 shows the premature hydration of a GCL being gathered up by hand to be discarded in the adjacent landfill.

Some recommended specifications or CQA document items are as follows:

1. The GCL should be covered with its subsequent layer before a rainfall or snowfall occurs.
2. The GCL should not be covered before observation and approval by the CQA personnel. This requires close coordination between the installation crew and the CQA personnel.
3. If soil is to cover the GCL it should be done such that the GCL or underlying materials are not damaged. Unless otherwise specified, the direction of backfilling should proceed in the direction of downgradient shingling of the GCL overlaps. Continuous observation of the soil placement is recommended.
4. If a geosynthetic is to cover a GCL, both underlying and the newly deployed material should not be damaged.

5. The overlying material should not be deployed such that excess tensile stress is mobilized in the GCL. On side slopes, this requires soil backfill to proceed from the bottom of the slope upward. Other conditions are site specific and material specific.

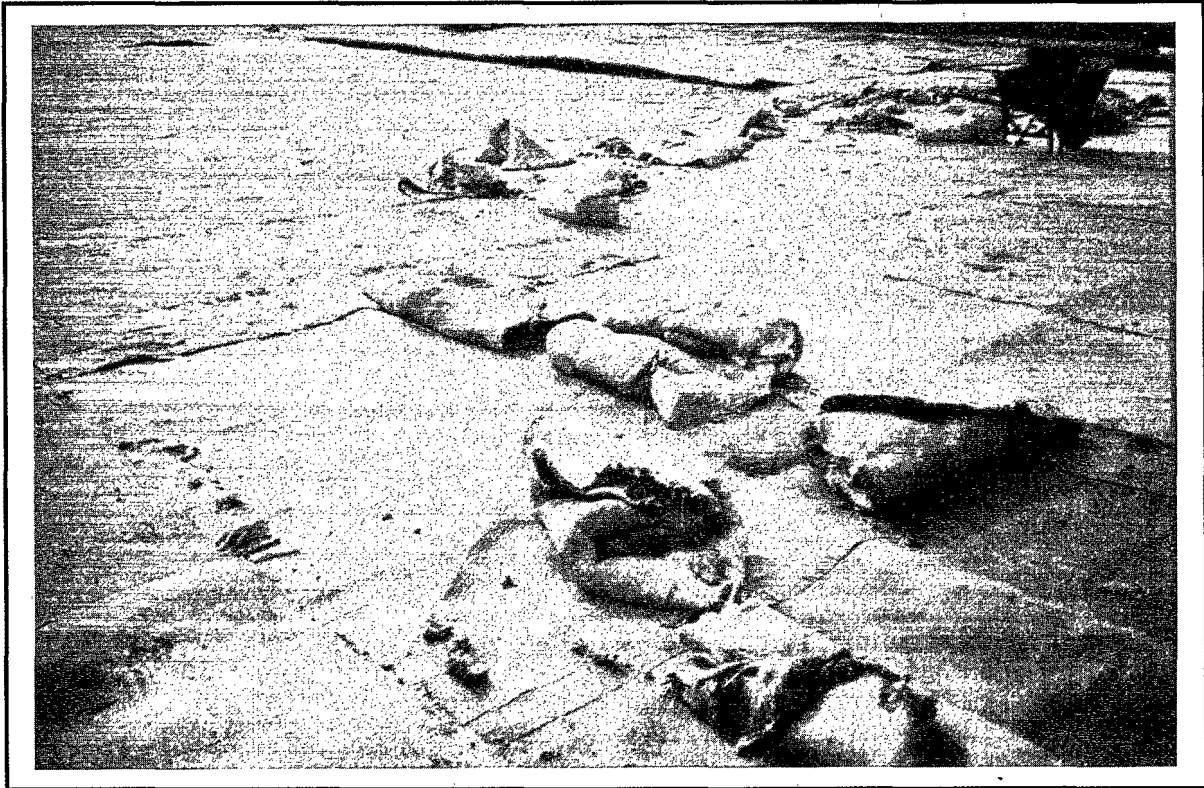

Figure 4.7 - Premature Hydration of a Geosynthetic Clay Liner Being Gathered and Discarded due to its Exposure to Rainfall Before Covering

4.6 References

API 13B, "Fluid Loss of Bentonite Clays"

ASTM B-417, "Apparent Density of Non Free-Flowing Metal Powders"

ASTM C-136, "Sieve Analysis of Fine and Coarse Aggregates"

ASTM D-413, "Rubber Property - Adhesion to Flexible Substrate"

ASTM D-422, "Particle Size Analysis of Soils"

ASTM D-1777, "Measuring Thickness of Textile Materials"

ASTM D-2216, "Laboratory Determination of Water (Moisture) Content of Soil and Rock"

ASTM D-4318, "Liquid Limit, Plastic Limit, and Plasticity Index of Soils"

ASTM D-4354, "Sampling of Geosynthetics for Testing"

ASTM D-4643, "Determination of Water (Moisture Content) of Soil by Microwave Oven Method"

ASTM D-4759, "Determining the Specification Conformance of Geosynthetics"

ASTM D-4873, "Identification, Storage and Handling of Geotextiles"

ASTM D-4972, "Method for pH of Soils"

ASTM D-5084, "Hydraulic Conductivity of Saturated Porous Material Using A Flexible Wall Permeameter"

ASTM D-5199, "Nominal Thickness of Geotextiles and Geomembranes"

ASTM D-5261, "Measuring Mass per Unit Area of Geotextiles"

ASTM D-5321, "Determining the Coefficient of Soil and Geosynthetic or Geosynthetic and Geosynthetic Friction by the Direct Shear Method"

ASTM E-946, "Water Absorption of Bentonite of Porous Plate Method"

GRI GCL1, "Free Swell Conformance Test of Clay Component of a GCL"

GRI GCL2, "Permeability of Geosynthetic Clay Liners (GCLs)"

USP-NF-XVII, "Swell Index Test"

Chapter 5

Soil Drainage Systems

5.1 Introduction and Background

Natural soil drainage materials are used extensively in waste containment units. The most common uses are:

1. Drainage layer in final cover system to reduce the hydraulic head on the underlying barrier layer and to enhance slope stability by reducing seepage forces in the cover system.
2. Gas collection layer in final cover systems to channel gas to vents for controlled removal of potentially dangerous gases.
3. Leachate collection layer in liner systems to remove leachate for treatment and to remove precipitation from the disposal unit in areas where waste has not yet been placed.
4. Leak detection layer in double liner systems to monitor performance of the primary liner and, if necessary, to serve as a secondary leachate collection layer.
5. Drainage trenches to collect horizontally-flowing fluids, e.g., ground water and gas.

Drainage layers are also used in miscellaneous ways, such as to drain liquids from backfill behind retaining walls or to relieve excess water pressure in critical areas such as the toe of slopes.

5.2 Materials

Soil drainage systems are constructed of materials that have high hydraulic conductivity. High hydraulic conductivity is not only required initially, but the drainage material must also maintain a high hydraulic conductivity over time and resist plugging or clogging. The hydraulic conductivity of drainage materials depends primarily on the grain size of the finest particles present in the soil. An equation that is occasionally used to estimate hydraulic conductivity of granular materials is Hazen's formula:

$$k = (D_{10})^2 \quad (5.1)$$

where k is the hydraulic conductivity (cm/s) and D_{10} is the equivalent grain diameter (mm) at which 10% of the soil is finer by weight. To determine the value of D_{10} , a plot is made of the grain-size distribution of the soil (measured following ASTM D-422) as shown in Fig. 5.1. The equivalent grain diameter (D_{10}) is determined from the grain size distribution curve as shown in Fig. 5.1.

Experimental data verify that the percentage of fine material in the soil dominates hydraulic conductivity. For example, the data in Table 5.1 illustrate the influence of a small amount of fines

upon the hydraulic conductivity of a filter sand. The addition of just a few percent of fine material to a drainage material can reduce the hydraulic conductivity of the drainage material by 100 fold or more.

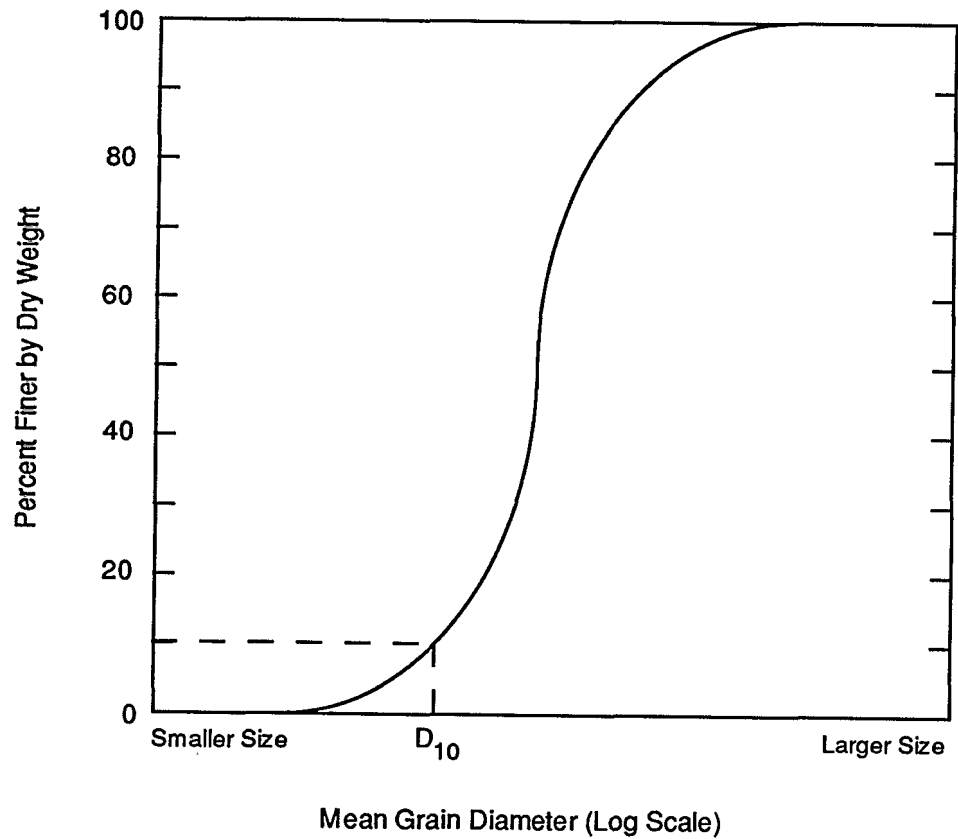

Figure 5.1 - Grain Size Distribution Curve

Construction specifications usually stipulate a minimum hydraulic conductivity for the drainage layer. The value specified varies considerably from project to project but is typically in the range of 0.01 to 1 cm/s. The method used to determine hydraulic conductivity in the laboratory is ASTM D-2434.

Table 5.1 Effect of Fines on Hydraulic Conductivity of a Washed Filter Aggregate (from Cedergren, 1989)

| Percent Passing No. 100* Sieve | Hydraulic Conductivity (cm/s) |
|-----------------------------------|-------------------------------|
| 0 | 0.03 to 0.11 |
| 2 | 0.004 to 0.04 |
| 4 | 0.0007 to 0.02 |
| 6 | 0.0002 to 0.007 |
| 7 | 0.00007 to 0.001 |

*Opening size is 0.15 mm.

Drainage materials may also be required to serve as filters. For instance, as shown in Fig. 5.2, a filter layer may be needed to protect a drainage layer from plugging. The filter layer must serve three functions:

1. The filter must prevent passage of significant amounts of soil through the filter, i.e., the filter must retain soil.
2. The filter must have a relatively high hydraulic conductivity, e.g., the filter should be more permeable than the adjacent soil layer.
3. The soil particles within the filter must not migrate significantly into the adjacent drainage layer.

Filter specifications vary somewhat, but the design procedures are similar. The determination of requirements for a filter material proceeds as follows:

1. The grain size distribution curve of the soil to be retained (protected) is determined following procedures outlined in ASTM D-422. The size of the protected soil at which 15% is finer ($D_{15, \text{soil}}$) and 85% is finer ($D_{85, \text{soil}}$) is determined.
2. Experience shows that the particles of the protected soil will not significantly penetrate into the filter if the size of the filter at which 15% is finer ($D_{15, \text{filter}}$) is less than 4 to 5 times D_{85} of the protected soil:

$$D_{15, \text{filter}} \leq (4 \text{ to } 5) D_{85, \text{soil}} \quad (5.2)$$

3. Experience shows that the hydraulic conductivity of the filter will be significantly greater than that of the protected soil if the following criterion is satisfied:

$$D_{15, \text{ filter}} \geq 4 D_{15, \text{ soil}} \quad (5.3)$$

4. To ensure that the particles within the filter do not tend to migrate excessively into the drainage layer, the following criterion may be applied:

$$D_{15, \text{ drain}} \leq (4 \text{ to } 5) D_{15, \text{ filter}} \quad (5.4)$$

5. Experience shows that the hydraulic conductivity of the drain will be significantly greater than that of the filter if the following criterion is satisfied:

$$D_{15, \text{ drain}} \geq 4 D_{15, \text{ filter}} \quad (5.5)$$

Filter design is complicated significantly by the presence of biodegradable waste materials, e.g., municipal solid waste, directly on top of the filter. In such circumstances, the usual filter criteria may be modified to satisfy site-specific requirements. Some degree of reduction in hydraulic conductivity of the filter layer may be acceptable, so long as the reduction does not impair the ability of the drainage system to serve its intended function. A laboratory test method to quantify the hydraulic properties of both soil and geotextile filters that are exposed to leachate is ASTM D-1987. However, regardless of specific design criteria, the gradational characteristics of the filter material control the behavior of the filter. CQC/CQA personnel should focus their attention on ensuring that the drainage material and filter material meet the grain-size-distribution requirements set forth in the construction specifications, as well as other specified requirements such as mineralogy of the materials.

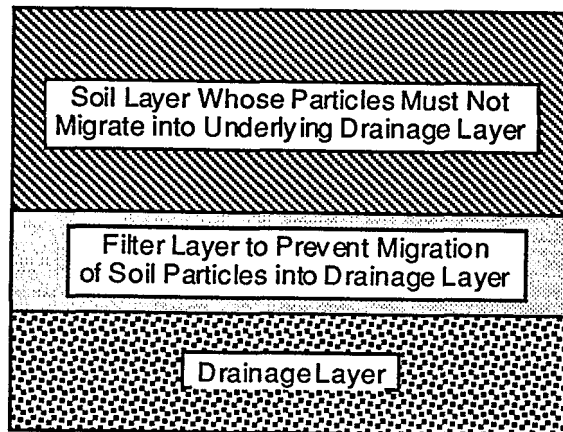

Figure 5.2 - Filter Layer Used to Protect Drainage Layer from Plugging

5.3 Control of Materials

The recommended procedure for verifying the hydraulic conductivity for a proposed drainage material is as follows. Samples of the proposed material should be obtained and shipped to a laboratory for testing. Samples should be compacted in the laboratory to a density that will be representative of the density to be used in the field. Hydraulic conductivity should be measured following procedures in ASTM D-2434 and compared with the required minimum values stated in the construction specifications. If the hydraulic conductivity exceeds the minimum value, the material is tentatively considered to be acceptable. However, it should be realized that the process of excavating and placing the drainage material will cause some degree of crushing of the drainage material and will produce additional fines. Thus, the construction process itself tends to increase the amount of fines in the drainage material and to decrease the hydraulic conductivity of the material. If the drainage material just barely meets the hydraulic conductivity requirements stated in the construction specifications from initial tests, there is a good possibility that the material will fail to meet the required hydraulic conductivity standard after the material has been placed. As a rule of thumb, approximately one-half to one percent of additional fines by weight will be generated every time a drainage material is handled, e.g., one-half to one percent additional fines would be generated when the drainage layer material is excavated and an additional one-half to one percent of fines would be generated when the material is placed. Also, the reproducibility of hydraulic conductivity tests is not well established; a material may just barely meet the hydraulic conductivity standard in one test but fail to meet minimum requirements in another test. Finally, if the drainage materials are found to be suitable prior to placement but unsuitable after placement, an extremely difficult situation arises -- it is virtually impossible to remove and replace the drainage material without risking damage to underlying geosynthetic components, e.g., a geomembrane. Therefore, some margin of safety should be factored into the selection of drainage material.

Because it is extremely difficult to remove and replace a drainage material without damaging an underlying geosynthetic component, testing of the drainage material should occur prior to placement of the material. The CQC personnel should have a high degree of confidence that the drainage material is suitable prior to placement of the material. Because the construction process may alter the characteristics of the drainage material, it is important that CQA tests also be performed on the material after it has been placed and compacted (if it is compacted).

The usual tests involve determination of the grain size distribution of the soil (ASTM D-422) and hydraulic conductivity of the soil (ASTM D-2434). Hydraulic conductivity tests tend to be time consuming and relatively difficult to reproduce precisely; the test apparatus that is employed, the compaction conditions for the drainage material, and other details of testing may significantly influence test results. Grain-size distribution analyses are simpler. Therefore, it is recommended that the CQA testing program emphasize grain-size distribution analyses, with particular attention paid to the amount of fines present in the drainage material, rather than hydraulic conductivity testing. The percent of fines is normally defined as the percent on a dry weight basis passing through a No. 200 sieve (openings of 0.075 mm). Again, it is emphasized that close testing and inspection of the borrow source or the supplier prior to placement of the material is critical, particularly if the drainage material is underlain by a geosynthetic material.

The recommended tests and frequency of testing are shown in Table 5.2. The same principles for sampling strategies discussed in Chapter 2 may be applied to location of tests or location of samples for drainage layer materials. Also, occasional failing tests may be allowed, but it is recommended that no more than 5% of the CQA tests be allowed to deviate from specifications, and the deviations should be relatively minor, i.e., no more than about 2% fines beyond the maximum value allowed and no less than about one-fifth the minimum allowable hydraulic conductivity.

Table 5.2 - Recommended Tests and Testing Frequencies for Drainage Material

| Location of Sample | Type of Test | Minimum Frequency |
|--|---|---|
| Potential Borrow Source | Grain Size (ASTM D-422) | 1 per 2,000 m ³ |
| | Hydraulic Conductivity (ASTM D-2434) | 1 per 2,000 m ³ |
| | Carbonate Content* (ASTM D-4373) | 1 per 2,000 m ³ |
| On Site; After Placement and Compaction | Grain Size (ASTM D-422) | 1 per Hectare for Drainage Layers; 1 per 500 m ³ for Other Uses |
| | Hydraulic Conductivity (ASTM D-2434) | 1 per 3 Hectares for Drainage Layers; 1 per 1,500 m ³ for Other Uses |
| | Carbonate Content* (ASTM D-4373) | 1 per 2,000 m ³ |

*The frequency of carbonate content testing should be greatly reduced to 1 per 20,000 m³ for those drainage materials that obviously do not and cannot contain significant carbonates (e.g., crushed basalt).

5.4 Location of Borrow Sources

The construction specifications usually establish criteria that must be met by the drainage material. Earthwork contractors are normally given latitude in locating a suitable source of material that meets construction specifications. On occasion the materials may be available on site or from a nearby piece of property, but most frequently the materials are supplied by a commercial materials company. If the materials are supplied by an existing materials processor, stockpiles of materials are usually readily available for testing and no geotechnical investigations are required, other than to test the proposed borrowed material.

5.5 Processing of Materials

Materials may be processed in several ways. Oversized stones or rocks are typically removed by sieving. Fine material may also be removed by sieving. Washing the fines out of a sand or gravel can be particularly effective in removing silt and clay sized particles from granular

material. For drainage layer materials that are supplied from a commercial processing facility, the facility owner is usually experienced in processing the material to remove fines.

For the CQA inspector the main processing issues are removal of oversized material, removal of angular material (if required to minimize potential to puncture a geomembrane), and assurance that excessive fines will not be present in the material.

On occasion the amount of limestone, dolostone, dolomite, calcite, or other carbonates in the drainage material may be an issue. Carbonate materials are slightly soluble in water. If the drainage material contains excessive carbonate, the carbonate may dissolve at one location and precipitate at another, plugging the material. CQA inspectors should also be cognizant of the need to make sure that carbonate components are not present in excessive amounts. If the specifications place a limit on carbonate content, tests should be performed to confirm compliance (Table 5.2).

5.6 Placement

Drainage materials may be placed in layers (e.g., as leachate collection layers) or they may be placed in drainage trenches (e.g., to provide drainage near the toe of a slope). Placement considerations differ depending on the application.

5.6.1 Drainage Layers

Granular drainage materials are usually hauled to the placement area in dump trucks, loosely dumped from the truck, and spread with bulldozers. The contractor should dump and spread the drainage material in a manner that minimizes generation of fine material. For instance, light-contact-pressure dozers can be used to spread the drainage material and minimize the stress on the granular material. Granular materials placed on top of geosynthetic components on side slopes should be placed from the bottom of the slope up.

When granular drainage material is placed on a previously-placed geomembrane or geotextile and spread with a dozer, the sand or gravel should be lifted and tumbled forward so as to minimize shear forces on the underlying geosynthetic. The dozer should not be allowed to "crowd" the blade into the granular material and drag it over the surface of the underlying geosynthetic material.

Granular materials are often placed with a backhoe in small, isolated areas such as sumps. Some drainage materials may even be placed by hand, e.g., in sumps and around drainage pipes.

CQA personnel should position themselves in front of the working face of the placement operation to be able to observe the materials as they are spread and to ensure that there is no puncture of underlying materials. CQA personnel should observe placement of drainage layers to ensure that fine-grained soil is not accidentally mixed with drainage material.

5.6.2 Drainage Trenches

Drainage materials are often placed in trenches to provide for subsurface drainage of water. A typical trench configuration is shown in Fig. 5.3. Often, a perforated pipe will be placed in the bottom of the trench. Geotextile filters are often required along the side walls to prevent migration of fine particles into the drainage material. CQA personnel should carefully review the plans and specifications to ensure that the drainage and filter components have been properly located in the trench prior to backfill.

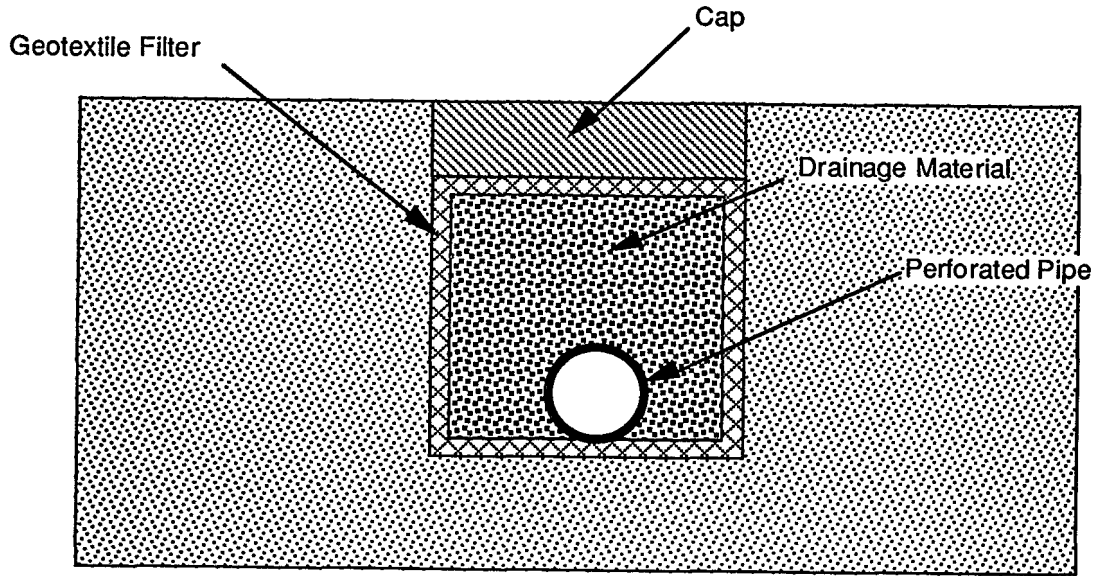

Figure 5.3 - Typical Design of a Drainage Trench

CQC/CQA personnel should be aware of all applicable safety requirements for inspection of trenches. Unsupported trenches can pose a hazard to personnel working in the trench or inspecting the trench. For trenches that are supported by shoring, CQA personnel should review with the contractor the plan for pulling the shoring in terms of the timing for placement of materials and ensure that the procedures are in accord with the specifications for the project.

Granular backfill is usually placed in a trench by a backhoe. For narrow trenches, a "tremie" is commonly used to direct the material into the trench without allowing the material to come into contact with soil on the sidewalls of the trench. Sometimes drainage materials are placed by hand for very small trenches.

A special type of trench involves support of the trench wall with a biodegradable ("biopolymer") slurry. The trench is excavated into soil using a biodegradable, viscous fluid to maintain the stability of the trench. The backfill is placed into the fluid-filled trench. An agent is introduced to promote degradation of the viscous drilling fluid, which quickly loses much of its viscosity and allows the granular backfill to attain a high hydraulic conductivity without any plugging effect from the slurry. This technology allows construction of deep, continuous drainage trenches but is used much more often for remediation of contaminated sites than in new waste containment facilities. Further details are given by Day (1990).

5.7 Compaction

Many construction specifications stipulate a minimum percentage compaction for granular drainage layers. There is rarely a need to compact drainage materials. However, on occasion, there may be a need to compact a drainage material for one of the following reasons:

1. If a settlement-sensitive structure is to be placed on top of the drainage layer, the drainage layer may need to be compacted to minimize settlement.
2. If dynamic loads might cause loose drainage material to liquefy or settle excessively, the material may need to be compacted.
3. If the drainage material must have exceptionally high strength, the material may need to be compacted.

Only in rare instances will the problems listed above be significant. Settlement-sensitive structures are rarely built on top of liner or cover systems. Liquefaction is rarely an issue because the hydraulic conductivity of the drainage material is normally sufficiently large to preclude the possibility of liquefaction. Strength is rarely a problem with granular materials. Reasons not to compact the drainage layer are as follows:

1. Compacting the drainage material increases the amount of fines in the drainage material, which decreases hydraulic conductivity.
2. Compacting the drainage layer reduces the porosity of the material, which decreases hydraulic conductivity.
3. Dynamic compaction stresses may damage underlying geosynthetics.

Unless there is a sound reason why the drainage material should be compacted, it is recommended that the drainage material not be compacted. The main goal of the drainage layer is to remove liquids, and this can only be accomplished if the drainage layer has high hydraulic conductivity. The uncompacted drainage layer may be slightly compressible, but the amount of compression is expected to be small.

There is a potential problem with drainage layer materials placed on side slopes. In some situations the friction between the drainage layer and underlying geosynthetic component may not be adequate to maintain stability of the side slope. CQA personnel should assume that the designer has analyzed slope stability and designed stable slide slopes for assumed materials and conditions. However, CQA personnel should be vigilant for evidence of slippage at the interface between the drainage layer and an underlying geosynthetic component. If problems are noted, the design engineer should be notified immediately.

5.8 Protection

The main protection required for the drainage layer is to ensure that large pieces of waste material do not penetrate excessively into the layer and that fines do not contaminate the layer. Many designs call for placement of protective soil or select waste on top of the leachate collection layer. As shown in Fig. 5.4, CQA personnel should stand near the working face of the first lift of solid waste placed on top of a leachate collection layer in a solid waste landfill to observe placement of select material.

Wind-borne fines may contaminate drainage materials. Soil erosion from adjacent slopes may also lead to accumulation of fines in the drainage material. The CQA personnel cannot complete their job until the drainage material is fully covered and protected.

Residual fines may be washed by rain from other soils, or the drainage material itself, during rain storms and accumulate in low areas. The accumulation of fines in sumps or other low

points can reduce the effectiveness of the drainage system. CQC/CQA personnel should be aware of this potential problem and watch for (1) areas where fines may be washed into the drainage material; and (2) evidence of lack of free drainage in low-lying areas (e.g., development of ponds of water in the drainage material in low-lying areas). If excessive fines are washed into a portion of the drainage material, the design engineer should be contacted for further evaluation prior to covering the drainage material by the next successive layer in the system.



Figure 5.4 -- CQC and CQA Personnel Observing Placement of Select Waste on Drainage Layer.

5.9 References

ASTM D-422, "Particle Size Analysis of Soils"

ASTM D-1987, "Biological Clogging of Geotextile or Soil/Geotextile Filters"

ASTM D-2434, "Permeability of Granular Soils"

ASTM D-4373, "Calcium Carbonate Content of Soils"

Cedergren, H.R. (1989), *Seepage, Drainage, and Flow Nets*, Third Edition, John Wiley & Sons, New York, 465 p.

Day, S. R. (1990), "Excavation/Interception Trenches by the Bio-Polymer Slurry Drainage Trench Technique," *Superfund '90*, Hazardous Materials Control Research Institute, Silver Spring, Maryland, pp. 382-385.

Chapter 6

Geosynthetic Drainage Systems

6.1 Overview

The collection of liquids in waste containment systems, their drainage and eventual removal represents an important element in the successful functioning of these facilities. Focus in this chapter is on the primary and secondary leachate collection systems beneath solid waste and on surface water and gas removal systems in the cover above the waste. This chapter parallels Chapter 5 on natural soil drainage materials but now using geosynthetics. Combined systems such as geocomposites and geospacers are often used; however we will generally focus on the individual geosynthetic components. The individual materials to be described are the following:

- geotextiles used as filters over various drainage systems (geonets, geocomposites, sands and gravels)
- geotextiles used for gas collection
- geonets used as primary and/or secondary leachate collection systems, and gas collection
- other geosynthetic drainage systems used as surface water collection systems and possibly as primary and/or secondary leachate collection systems

The locations of the various geosynthetic materials listed above are illustrated in the sketch of Fig. 6.1.

6.2 Geotextiles

Geotextiles, which some refer to as filter fabrics or construction fabrics, consist of polymeric yarns (fibers) made into woven or nonwoven textile sheets and supplied to the job site in large rolls. When ready for placement, the rolls are removed from their protective covering, properly positioned and unrolled over the substrate material. The substrate upon which the geotextile is placed is usually a geonet, geocomposite, drainage soil or other soil material. The roll edges and ends are either overlapped for a specified distance, or are sewn together. After approval by the CQA personnel, the geotextile is covered with the overlying material. Depending on site specific conditions, this overlying material can be a geomembrane, geosynthetic clay liner, compacted clay liner, geonet, or drainage soil.

This section presents the MQA aspects of geotextiles insofar as their manufacturing is concerned and the CQA aspects as far as handling, seaming and backfilling is concerned.

6.2.1 Manufacturing of Geotextiles

The manufacturing of geotextiles made from polymeric fibers follows traditional textile manufacturing methods and uses similar equipment. It should be recognized at the outset that most manufacturing facilities have developed their respective geotextile products to the point where product quality control procedures and programs are routine and fully developed.

Three discrete stages in the manufacture of geotextiles should be recognized from an MQA perspective: (1) the polymeric materials; (2) yarn or fiber type; and (3) fabric type (IFAI, 1990).

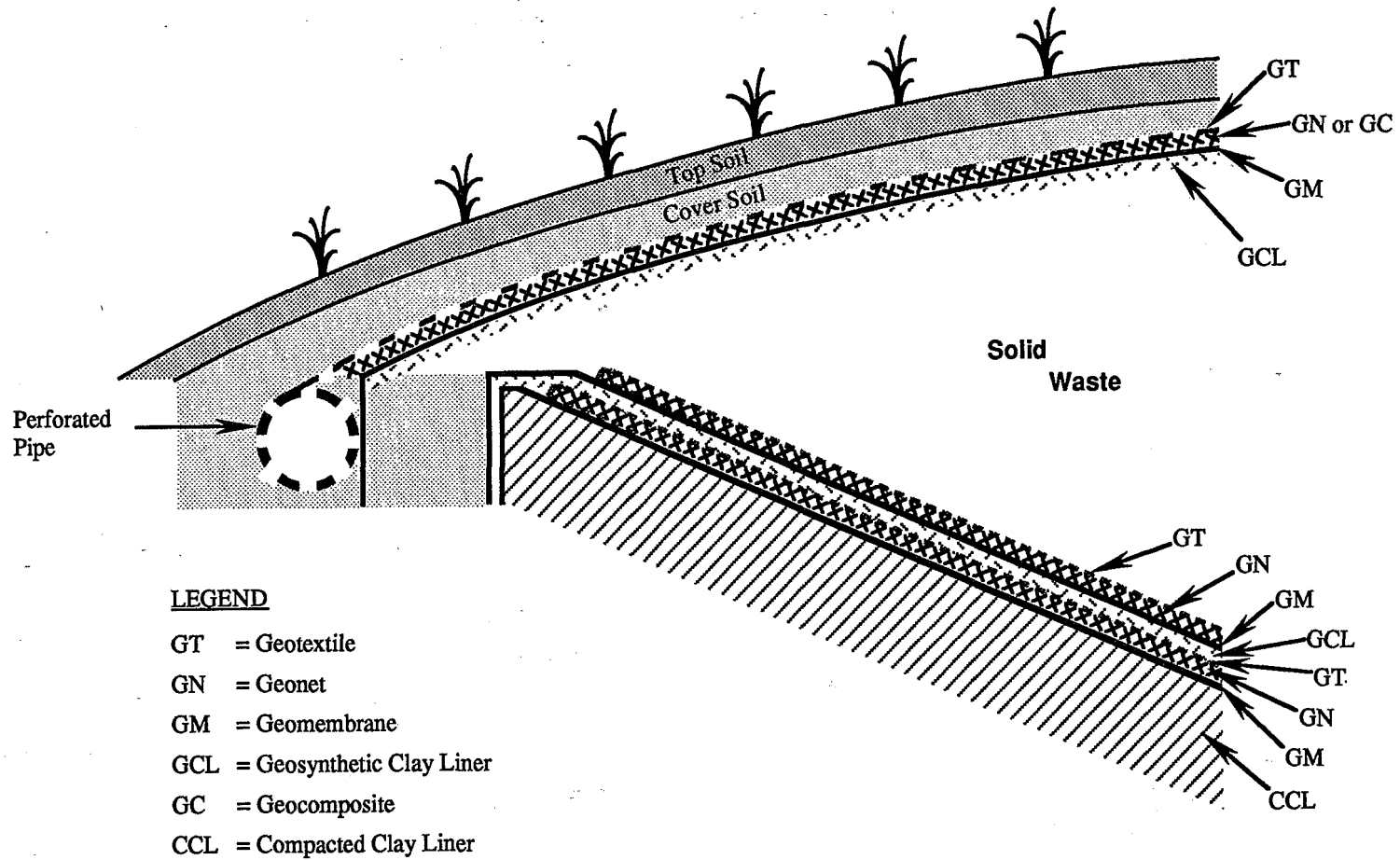

Figure 6.1 - Cross Section of a Landfill Illustrating the Use of Different Geosynthetics Involved in Waste Containment Drainage Systems

6.2.1.1 Resins and Their Additives

Approximately 75% of geotextiles used today are based on polypropylene resin. An additional 20% are polyester and the remaining 5% is a range of polymers including polyethylene, nylon and others used for specialty purposes. As with all geosynthetics, however, the base resin has various additives formulated with it resulting in the final compound. Additives for ultraviolet light protection and as processing aids are common, see Table 6.1.

Table 6.1 - Compounds Used in The Manufacture of Geotextiles (Values Are Percentages Based on Weight)

| Generic Name | Resin | Carbon Black | Other Additives |
|---------------|---------|--------------|-----------------|
| Polypropylene | 95 - 98 | 0 - 3 | 0 - 2 |
| Polyester | 97 - 98 | 0 - 1 | 0 - 2 |
| Others | 95 - 98 | 1 - 3 | 1 - 2 |

The resin is usually supplied in the form of pellets which is then blended with carbon black, either in the form of concentrate pellets or chips, or as a powder, and the additive package. The additive package is usually a powder and is proprietary with each particular manufacturer. For some manufacturers, the pellets are precompounded with carbon black and/or the entire additive package. Figure 6.2 shows polyester chips and carbon black concentrate pellets used in the manufacturer of polyester geotextiles. Polypropylene pellets and carbon black are similar to those shown in the manufacture of polyethylene geomembranes. Refer to Chapter 3 for details and in particular to Section 3.2.2 for use of recycled and/or reclaimed material.

The following items should be considered for a specification or MQA document for resins and additives used in the manufacture of geotextiles for waste containment applications.

1. The resin should meet MQC requirements. This usually requires a certificate of analysis to be submitted by the resin vendor for each lot supplied. Included will be various properties, their specification limits and the appropriate test methods. For polypropylene resin, the usual requirements are melt flow index, and other properties felt to be relevant by the manufacturer. For polyester resin, the usual requirements are intrinsic viscosity, solution viscosity, color, moisture content and other properties felt to be relevant by the manufacturer.
2. The internal quality control of the manufacturer should be reported to verify that the geotextile manufactured for the project meets the proper specifications.
3. The frequency of performing each of the preceding tests should be covered in the MQC plan and should be implemented and followed.

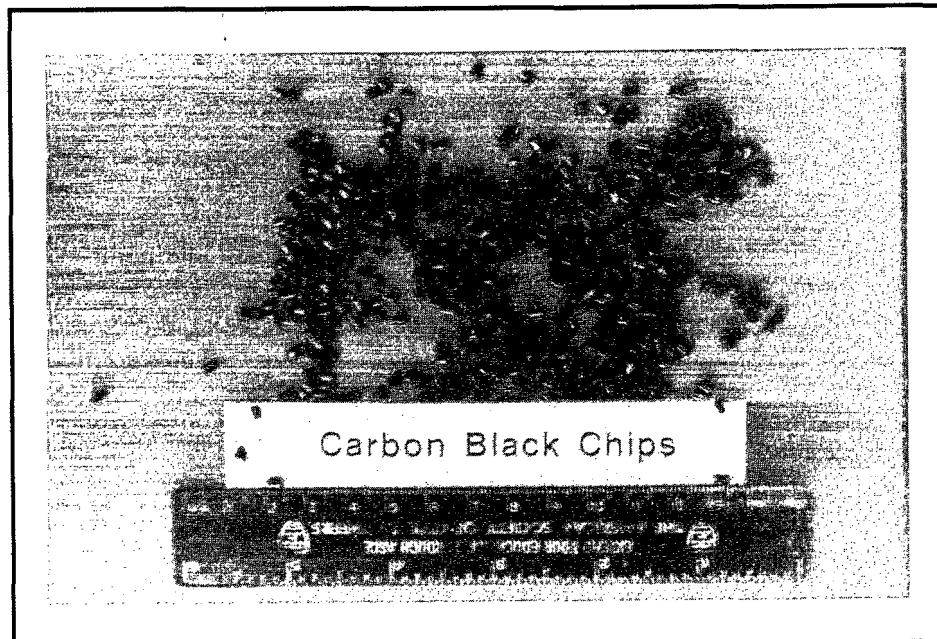
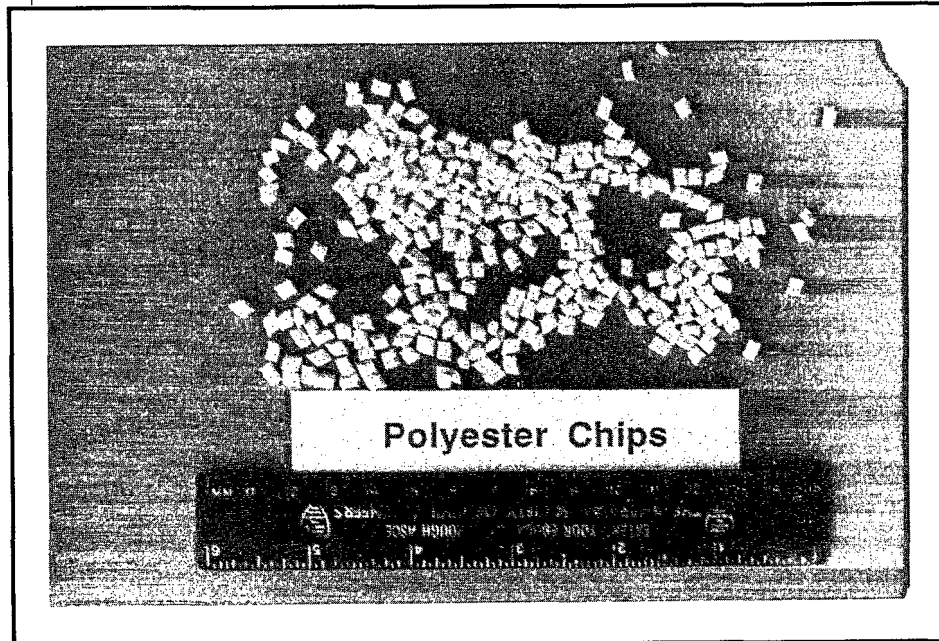

Figure 6.2 - Polyester Resin Chips (Upper) and Carbon Black Concentrate Pellets (Lower) Used for Geotextile Fiber Manufacturing

4. The percentage, according to ASTM D-1603, and type of carbon black should be specified for the particular formulation being used, although it is low in comparison to geomembranes.
5. The type and amount of stabilizers are rarely specified. If a statement is required it should signify that the stabilizer package has been successfully used in the past and to what extent.

6.2.1.2 Fiber Types

The resin, carbon black and stabilizers are introduced to an extruder which supplies heat, mixing action and filtering. It then forces the molten material to exit through a die containing many small orifices called a "spinnerette". Here the fibers, called "yarns", are usually drawn (work hardened) by mechanical tension, or impinged by air, as they are stretched and cooled. The resulting yarns, called "filaments", can be wound onto a bobbin, or can be used directly to form the finished product. Other yarn manufacturing variations include those made from staple fibers and flat, tape-like, yarns called "slit-film". Each type (filament, staple or slit-film) can be twisted together with others as shown in Fig. 6.3. Note that "yarn" is a generic term for any continuous strand (fiber, filament or tape) used to form a textile fabric. Thus all of the examples in Fig. 6.3 are yarns, except for staple, and can be used to manufacture geotextiles.

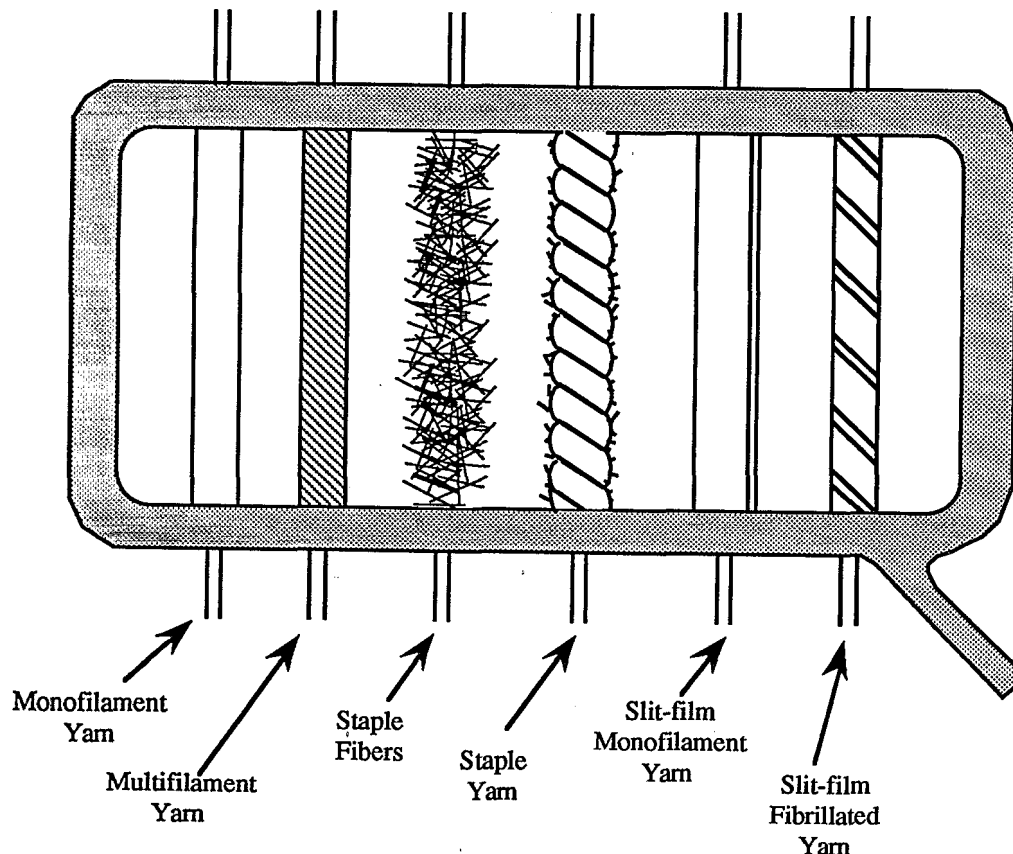

Figure 6.3 - Types of Polymeric Fibers Used in the Construction of Different Types of Geotextiles

6.2.1.3 Geotextile Types

The yarns just described are joined together to make a fabric, or geotextile. Generic classifications are woven, nonwoven and knit. Knit geotextiles, however, are rarely used in waste containment systems and will not be described further in this document.

The manufacturer of a woven geotextile uses the desired type of yarn from a bobbin and constructs the fabric on a weaving loom. Fabric weaving technology is well established over literally centuries of development. Most woven fabrics used for geotextiles are “simple”, or “basket-type” weaves consisting of each yarn going over and under an intersecting yarn on an alternate basis. Figure 6.4(a) shows a micrograph of a typical woven geotextile pattern.

In contrast to this type of uniformly woven pattern are nonwoven fabrics as shown in Figs. 6.4(b) and (c). Here the yarns are utilized directly from the extruding spinnerette and laid down on a moving belt in a random fashion. The speed of the moving belt dictates the mass per unit area of the final product. While positioned on the belt the material is “lofty”, and the yarns are not structurally bound in any way. Two variations of structural bonding can be used, which gives rise to two unique types of nonwoven geotextiles.

- Nonwoven, needlepunched geotextiles go through a needling process wherein barbed needles penetrate the fabric and entangle numerous fibers transverse to the plane of the fabric. Note the fiber entanglement pattern in Fig. 6.4(b). As a post-processing step, the fabric can be passed over a heated roller resulting in a singed or burnished surface of the yarns on one or both sides of the fabric.
- Nonwoven, heat bonded geotextiles are formed by passing the unbonded fiber mat through a source of heat, usually steam or hot air, thereby melting some of the fibers at various points. Note the fiber bonding pattern in Fig. 6.4(c). This compresses the mat and simultaneously joins the fibers at their intersections by melt bonding.

6.2.1.4 General Specification Items

There are numerous items recommended for inclusion in a specification or MQA document for geotextiles used in waste containment facilities.

1. There should be verification and certification that the actual geotextile properties meet the manufacturers specification for that particular type and style.
2. Quality control certifications should include, at a minimum, mass per unit area per ASTM D-5261, grab tensile strength per ASTM D-4632, trapezoidal tear strength per ASTM D-4533, burst strength per ASTM D-3786, puncture strength per ASTM D-4833, thickness per ASTM D-5199, apparent opening size per ASTM D-4751, and permittivity per ASTM D-4491.
3. Values for each property should meet, or exceed, the project specification values, (note in some cases the property listed is a maximum value in which case lower values are acceptable).
4. A statement should be included that the property values listed are based upon the minimum average roll value (MARV) concept.

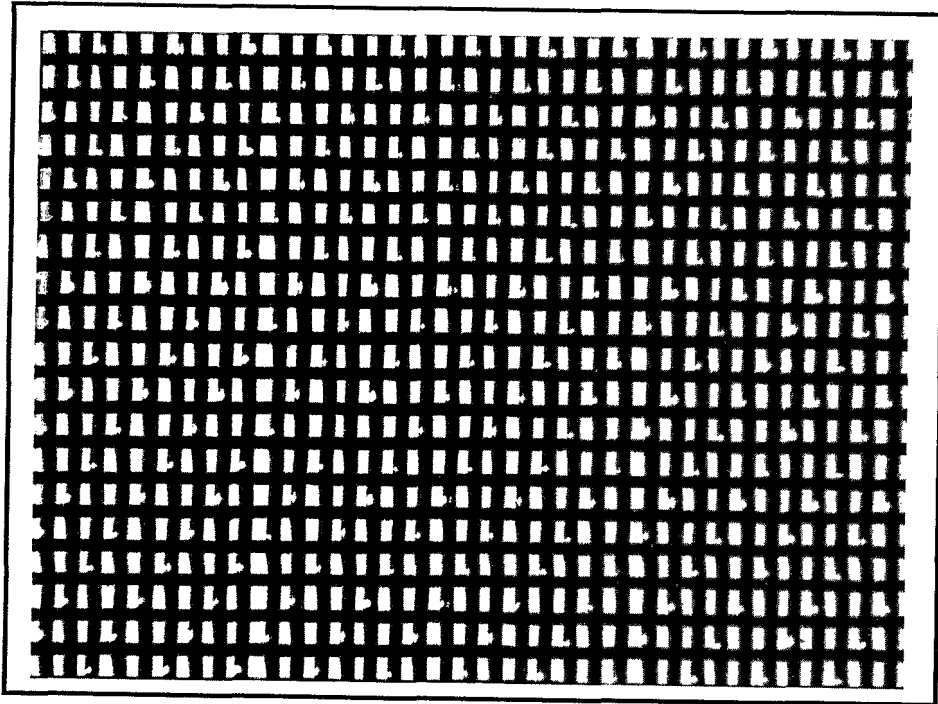

(a) Woven Geotextile at 4X Magnification

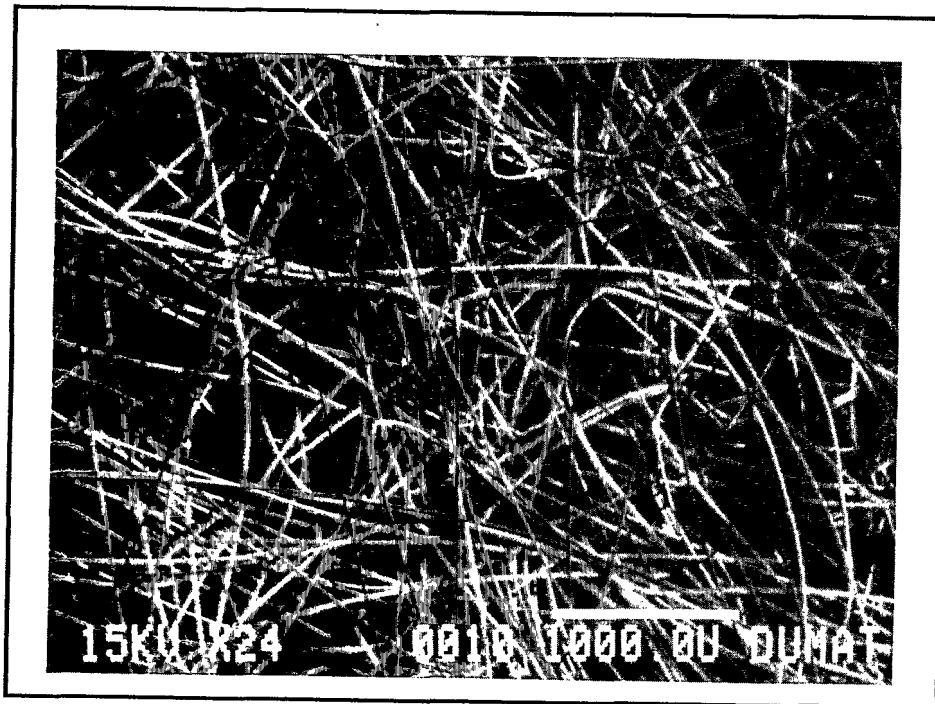

(b) Nonwoven Needlepunched Geotextile at 24X Magnification

Figure 6.4 - Three Major Types of Geotextiles (Continued on Next Page).

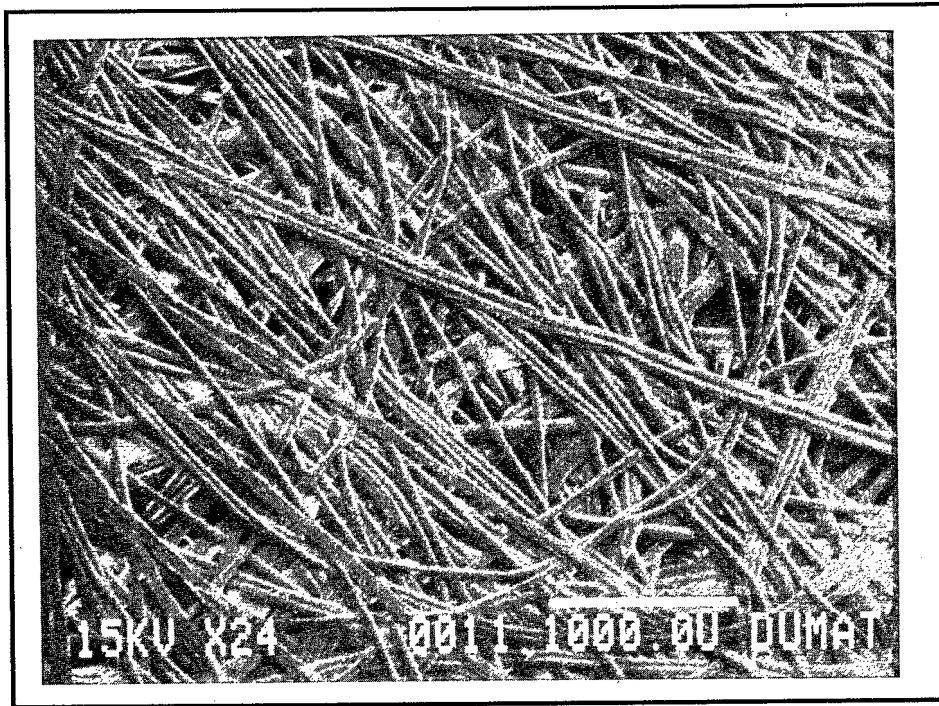

(c) Nonwoven Heatbonded Geotextile at 24X Magnification

Figure 6.4 - Three Major Types of Geotextiles (Continued from Previous Page)

5. The ultraviolet light resistance should be specified which is usually a certain percentage of strength or elongation retained after exposure in a laboratory weathering device. Usually ASTM D-4355 is specified and retention after 500 hours is typically 50% to 90%.
6. The frequency of performing each of the preceding tests should be covered in the manufacturer's MQC plan and it should be implemented and followed.
7. Verification that needle-punched, nonwoven geotextiles have been inspected continuously for the presence of broken needles using an in-line metal detector with an adequate sweep rate should be provided. Furthermore, a needle removal system, e.g., magnets, should be implemented.
8. A statement indicating if, and to what extent, reworked polymer, or fibers, was added during manufacturing. If used, the statement should note that the rework polymer, or fibers, was of the same composition as the intended product.
9. Reclaimed or recycled, i.e., fibers or polymer that has been previously used, should not be added to the formulation unless specifically allowed for in the project

specifications. Note, however, that reclaimed fibers may be used in geotextiles in certain waste containment applications. The gas collection layer above the waste and the geotextile protection layer between drainage stone and a geomembrane are likely locations. These should be design decisions and should be made accordingly.

6.2.2 Handling of Geotextiles

A number of activities occur between the manufacture of geotextiles and their final positioning at the waste facility. These activities involve protective wrapping, storage at the manufacturing facility, shipment, storage at the site, product acceptance, conformance testing and final placement at the facility. Each of these topics will be described in this section.

6.2.2.1 Protective Wrapping

All rolls of geotextiles, irrespective of their type, must be enclosed in a protective wrapping that is opaque and waterproof. The object is to prevent any degradation from atmospheric exposure (ultraviolet light, ozone, etc.), moisture uptake (rain, snow) and to a limited extent, accidental damage. It must be recognized that geotextiles are the most sensitive of all geosynthetics to degradation induced by ultraviolet light exposure. Geotextile manufacturers use tightly wound plastic wraps or loosely fit plastic bags for this purpose. Quite often the plastic is polyethylene in the thickness range of 0.05 to 0.13 mm (2 to 5 mil). Several important issues should be considered in a specification or MQA document.

1. The protective wrapping should be wrapped around (or placed around) the geotextile in the manufacturing facility and should be included as the final step in the manufacturing process.
2. The packaging should not interfere with the handling of the rolls either by slings or by the utilization of the central core upon which the geotextile is wound.
3. The protective wrapping should prevent exposure of the geotextile to ultraviolet light, prevent it from moisture uptake and limit minor damage to the roll.
4. Every roll must be labeled with the manufacturers name, geotextile style and type, lot and roll numbers, and roll dimensions (length, width and gross weight). Details should conform to ASTM D-4873.

6.2.2.2 Storage at Manufacturing Facility

The manufacturing of geotextiles is such that temporary storage of rolls at the manufacturing facility is necessary. Storage times range from a few days to a year, or longer. Figure 6.5(a) shows geotextile storage at a manufacturer's facility.

Regarding specification and MQA document items, the following should be considered.

1. Handling of rolls of geotextiles should be done in a competent manner such that damage does not occur to the geotextile nor to its protective wrapping. In this regard ASTM D-4873 should be referenced and followed.
2. Rolls of geotextiles should not be stacked upon one another to the extent that deformation of the core occurs or to the point where accessibility can cause damage in handling.

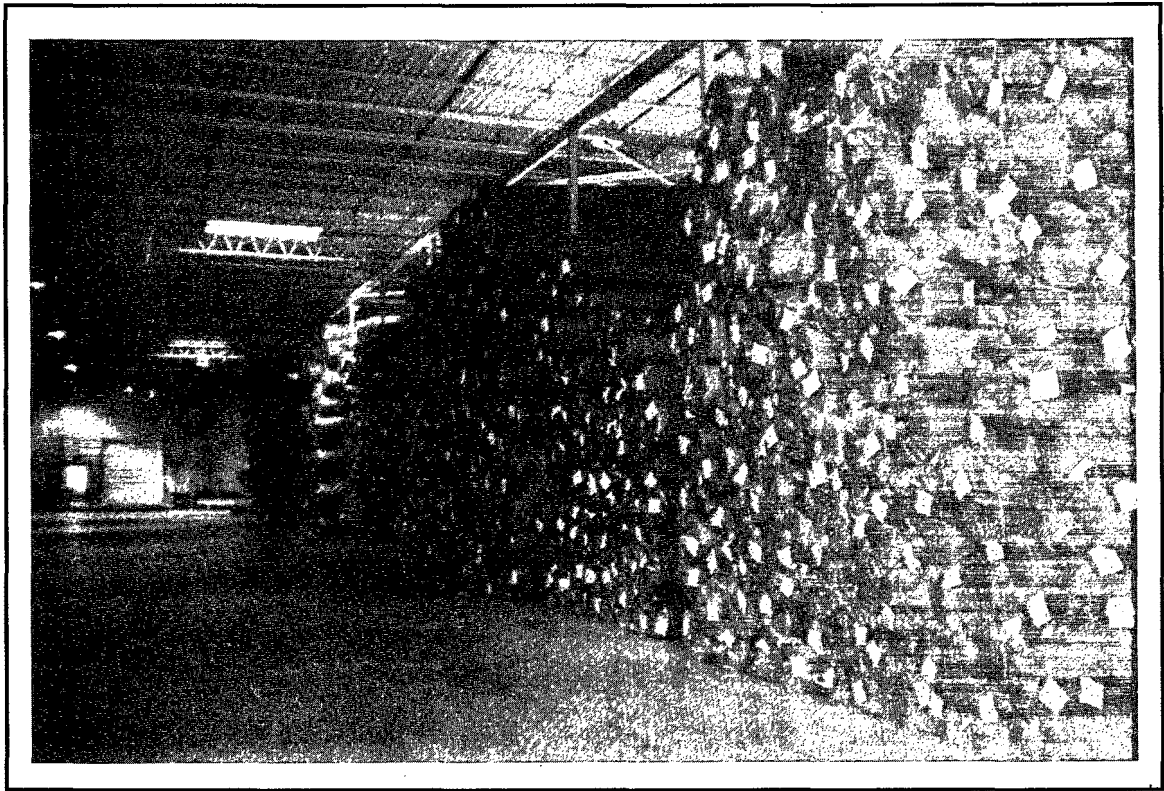

(a) Storage at Manufacturing Facility



(b) Storage at Field Site

Figure 6.5 - Photographs of Temporary Storage of Geotextiles

3. Outdoor storage of rolls at the manufacturer's facility should not be longer than six months. For storage periods longer than six months a temporary enclosure should be put over the rolls, or they should be moved to within a enclosed facility.

6.2.2.3 Shipment

Geotextile rolls are shipped from the manufacturer's (or their representatives) storage facility to the job site via common carrier. Ships, railroads and trucks have all been used depending upon the locations of the origin and final destination. The usual carrier from within the USA, is truck. When using flat-bed trucks the rolls are usually loaded by means of a crane with slings wrapped around the individual rolls. When the truck bed is closed, i.e., an enclosed trailer, the rolls are usually loaded by fork lift with a "stinger" attached. The "stinger" is a long tapered rod which fits inside the core upon which the geotextile is wrapped.

Insofar as specification and MQA/CQA documents are concerned the following items should be considered.

1. The method of loading the geotextile rolls, transporting them and off-loading them at the job site should not cause any damage to the geotextile, its core, nor its protective wrapping.
2. Any protective wrapping that is accidentally damaged or stripped off of the rolls should be repaired immediately or the roll should be moved to a enclosed facility until its repair can be made to the approval of the CQA personnel.

6.2.2.4 Storage at Field Site

Off-loading of geotextile rolls at the site and temporary storage which must be done in an acceptable manner. Figure 6.5(b) shows typical storage at the field site. Some specification and CQA document items to consider are the following.

1. Handling of rolls of geotextiles should be done in a competent manner such that damage does not occur to the geotextile nor to its protective wrapping. In this regard ASTM D-4873 should be referenced and followed.
2. The location of field storage should not be in areas where water can accumulate. The rolls should be elevated off of the ground so as not to form a dam creating the ponding of water.
3. The rolls should be stacked in such a way that cores are not crushed nor is the geotextile damaged. Furthermore, they should be stacked in such a way that access for conformance testing is possible.
4. Outdoor storage of rolls should not exceed manufacturers recommendations or longer than six months, whichever is less. For storage periods longer than six months a temporary enclosure should be placed over the rolls, or they should be moved within an enclosed facility.

6.2.2.5 Acceptance and Conformance Testing

Upon delivery of the rolls of geotextiles to the project site, and temporary storage thereof, the CQA engineer should see that conformance test samples are obtained. These samples are then

sent to the CQA laboratory for testing to ensure that the supplied geotextile conforms to the project plans and specifications. The samples are taken from selected rolls by removing the protective wrapping and cutting full-width, 1 m (3 ft) long samples off of the outer wrap of the selected roll(s). Sometimes the outer revolution of geotextile is discarded before the test sample is taken. The rolls are immediately re-wrapped and replaced in temporary field storage. The samples rolls must be relabeled for future identification. Alternatively, conformance testing could be performed at the manufacturer's facility and when completed the particular lot should be marked for the particular site under investigation. Items to be considered in a specification and CQA documents in this regard are the following:

1. The samples should be identified by type, style or, lot and roll numbers. The machine direction should be noted on the sample(s) with a waterproof marker.
2. A lot is defined as a unit of production, or a group of other units or packages having one or more common properties and being readily separable from other similar units. Other definitions are also possible and should be clearly stated in the CQA documents, see ASTM D-4354.
3. Sampling should be done according to the job specification and/or CQA documents. Unless otherwise stated, sampling should be based on one per lot. Note that a lot is sometimes defined as 10,000 m² (100,000 ft²) of geotextile. Utilization of ASTM D-4354 may be referenced and followed in this regard but it might result in a different value for sampling than stated above.
4. Testing at the CQA laboratory may include mass per unit area per ASTM D-5261, grab tensile strength per ASTM D-4632, trapezoidal tear strength per ASTM D-4533, burst strength per ASTM D-3786, puncture strength per ASTM D-4833, and possibly apparent opening size per ASTM D-4751, and permittivity per ASTM D-4491. Other conformance tests may be required by the project specifications.
5. Conformance test results should be sent to the CQA engineer prior to deployment of any geotextile from the lot under review.
6. The CQA engineer should review the results and should report any nonconformance to the Owner/Operator's Project Manager.
7. The resolution of failing conformance tests must be clearly stipulated in the specifications or CQA documents. Statements should be based upon ASTM D-4759 entitled "Determining the Specification Conformance of Geosynthetics".
8. The geotextile rolls which are sampled should be immediately rewrapped in their protective covering to the satisfaction of the CQA personnel.

6.2.2.6 Placement

The geosynthetic installation contractor should remove the protective wrappings from the geotextile rolls to be deployed only after the substrate layer, soil or other geosynthetic, has been documented and approved by the CQA personnel. The specification and CQA documents should be written in such a manner as to ensure that the geotextiles are not damaged nor excessively exposed to ultraviolet degradation. The following items should be considered for inclusion in a specification or CQA document.

1. The installer should take the necessary precautions to protect the underlying layers upon which the geotextile will be placed. If the substrate is soil, construction equipment can be used provided that excess rutting is not created. Excess rutting should be clearly defined and quantified by the design engineer. In some cases 25 mm (1.0 in.) is the maximum rut depth allowed. If the ground freezes, the depth of ruts should be further reduced to a specified value. If the substrate is a geosynthetic material, deployment must be by hand, by use of small jack lifts on pneumatic tires having low ground contact pressure, or by use of all-terrain vehicles, ATV's, having low ground contact pressure.
2. During placement, care must be taken not to entrap (either within or beneath the geotextile) stones, excessive dust or moisture that could damage a geomembrane, cause clogging of drains or filters, or hamper subsequent seaming.
3. On side slopes, the geotextiles should be anchored at the top and then unrolled so as to keep the geotextile free of wrinkles and folds.
4. Trimming of the geotextiles should be performed using only an upward cutting hook blade.
5. Nonwoven geotextiles placed on textured geomembranes can be troublesome due to sticking and are difficult to align or even separate after they are placed on one another. A thin sheet of plastic on the geomembrane during deployment of the geotextile can be very helpful in this regard. Of course, it is removed after correct positioning of the geotextile.
6. The geotextile should be weighted with sandbags, or the equivalent, to provide resistance against wind uplift. This is a site-specific procedure and completely the installer's decision. Uplifted and moved geotextiles can generally be reused but only after approval by the owner and observation by the CQA personnel.
7. A visual examination of the deployed geotextile should be carried out to ensure that no potentially harmful objects are present, e.g., stones, sharp objects, small tools, sandbags, etc.

6.2.3 Seaming

Seaming of geotextiles, by sewing, is sometimes required (versus overlapping with no sewn seams) of all geotextiles placed in waste facilities. This generally should be the case for geotextiles used in filtration, but may be waived for geotextiles used in separation (e.g., as gas collection layers above the waste or as protective layers for geomembranes) as per the plans and specifications. In such cases, heat bonding is also an acceptable alternate method of joining separation geotextiles. In cases where overlapping is permitted, the overlapped distance requirements should be clearly stated in the specification and CQA documents. Geotextile seam types and procedures, seam tests and geotextile repairs are covered in this section.

6.2.3.1 Seam Types and Procedures

The three types of sewn geotextile seams are shown in Fig. 6.6. They are the "flat" or "prayer" seam, the "J" seam and the "butterfly" seam. While each can be made by a single thread, or by a two-thread chain stitch, as illustrated, the latter stitch is recommended. Furthermore, a single, double, or even triple, row of stitches can be made as illustrated by the dashed lines in the

figures. Figure 6.7 shows a photograph of the fabrication of a flat seam and see Diaz (1990) for further details regarding geotextile seaming.

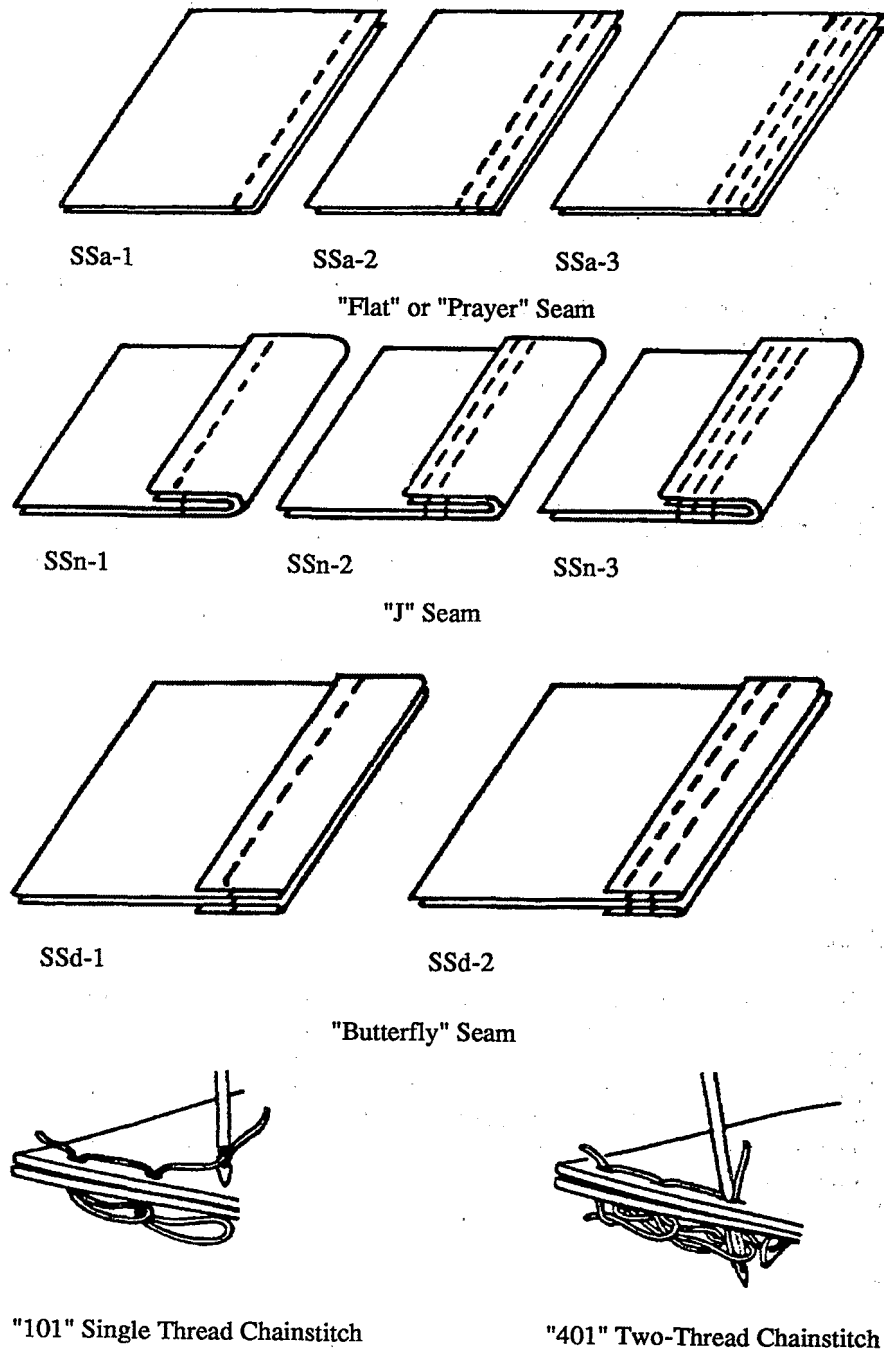

Figure 6.6 - Various Types of Sewn Seams for Joining Geotextiles (after Diaz, 1990)

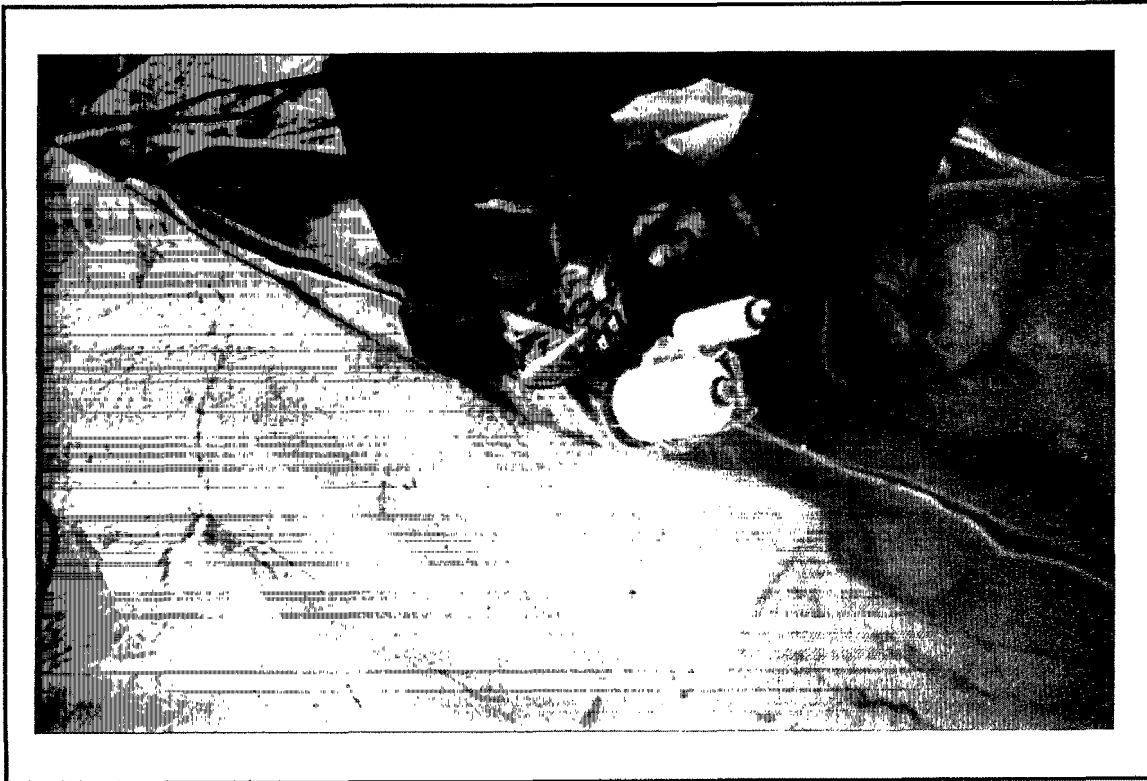

Figure 6.7 - Fabrication of a Geotextile Field Seam in a “Flat” or “Prayer” Seam Type

The project specification or CQA documents should address the following considerations.

1. The type of seam, type of stitch, stitch count or number of stitches per inch and number of rows should be specified based on the tendency of the fabric to fray, strength need and toughness of the fabric. For filtration and separation geotextiles a flat seam using a two-thread chain stitch and one row is usually specified. For reinforcement geotextiles, stronger and more complex seams are utilized. Alternatively, a minimum seam strength, per ASTM D-4884, could be specified.
2. The seams should be continuous, i.e., spot sewing is generally not allowed.
3. On slopes greater than approximately 5 (horiz.) to 1 (vert.), seams should be constructed parallel to the slope gradient. Exceptions are permitted for small patches and repairs.
4. The thread type must be polymeric with chemical and ultraviolet light resistant properties equal or greater than that of the geotextile itself.

5. The color of the sewing thread should contrast that of the color of the geotextile for ease in visual inspection. This may not be possible due to polymer composition in some cases.
6. Heat seaming of geotextiles may be permitted for certain seams. A number of methods are available such as hot plate, hot knife and ultrasonic devices.
7. Overlapped seams of geotextiles may be permitted for certain seams. The overlap distance should be stated depending on the site specific conditions.

6.2.3.2 Seam Tests

For geotextiles used in filtration and separation, seam samples and subsequent strength testing are not generally required. If they are, however, they should be stipulated in the specifications or CQA documents. Also, the sampling and testing frequency should be noted accordingly. The test method to evaluate sewn seam test specimens is ASTM D-4884.

6.2.3.3 Repairs

Holes, or tears, in geotextiles made during placement or anytime before backfilling should be repaired by patching. Some relevant specifications and CQA document items follow.

1. The patch material used for repair of a hole or tear should be the same type of polymeric material as the damaged geotextile, or as approved by the CQA engineer.
2. The patch should extend at least 30 cm (12 in.) beyond any portion of the damaged geotextile.
3. The patch should be sewn in place by hand or machine so as not to accidentally shift out of position or be moved during backfilling or covering operations.
4. The machine direction of the patch should be aligned with the machine direction of the geotextile being repaired.
5. The thread should be of contrasting color to the geotextile and of chemical and ultraviolet light resistance properties equal or greater than that of the geotextile itself.
6. The repair should be made to the satisfaction of the specification and CQA documents.

6.2.4 Backfilling or Covering

The layer of material placed above the deployed geotextile will be either soil, waste or another geosynthetic. Soils will vary from compacted clay layers to coarse aggregate drainage layers. Waste should be what is referred to as "select" waste, i.e., carefully separated and placed so as not to cause damage. Geosynthetics will vary from geomembranes to geosynthetic clay liners. Some considerations for a specification and CQA document to follow:

1. If soil is to cover the geotextile it should be done such that the geotextile is not shifted from its intended position and underlying materials are not exposed or damaged.
2. If a geosynthetic is to cover the geotextile, both the underlying geotextile and the newly deployed material should not be damaged during the process.

3. If solid waste is to cover the geotextile, the type of waste should be specified and visual observation by CQA personnel should be required.
4. The overlying material should not be deployed such that excess tensile stress is mobilized in the geotextile. On side slopes, this requires soil backfill to proceed from the bottom of the slope upward.
5. Soil backfilling or covering by another geosynthetic, should be done within the time frame stipulated for the particular type of geotextile. Typical time frames for geotextiles are within 14 days for polypropylene and 28 days for polyester geotextiles.

6.3 Geonets and Geonet/Geotextile Geocomposites

Geonets are unitized sets of parallel ribs positioned in layers such that liquid can be transmitted within their open spaces. Thus their primary function is drainage; recall Fig. 6.1. Figure 6.8(a) shows a photograph of rolls of geonets, while Fig. 6.8(b) shows a closeup of the intersection of a typical set of geonet ribs. Note that open space exists both in the plane of the geonet (above or under the parallel sets of ribs) and cross plane to the geonet (within the apertures between adjacent sets of ribs). In all cases, the apertures must be protected against migration and clogging by adjacent soil materials. Thus geonets always function with either geomembranes and/or geotextiles on their two planar surfaces. Whenever the geonet comes supplied with a geotextile on one or both of its surfaces, it is called a geocomposite. The geotextile(s) is usually bonded on the surface by heat fusing or by using an adhesive.

This section will describe the manufacturing and handling of geonets for waste containment facilities. Since continuity of liquid flow is necessary at the sides and ends of the rolls, joining methods will also be addressed, as will the placement of the covering layer. Also covered will be the bonding of geotextiles to geonets in the form of drainage geocomposites.

6.3.1 Manufacturing of Geonets

Geonets currently used in waste containment applications are formed using an extruder which accepts the intended polymer formulation and then melts, mixes, filters and feeds the molten material directly into a counter-rotating die. This die imparts parallel sets of ribs into the preform. Upon exiting the die, the ribs of the preform are opened by being forced over a steel spreading mandrel. Figure 6.9 shows a small laboratory size geonet as it is formed and expands into its final shape. The fully formed geonet is then water quenched, longitudinally cut in the machine direction, spread open as it exits the quench tank and rolled onto a handling core. The width of the rolls are determined by the maximum circumference of the spreading mandrel. Since the process is continuous in its operation, the roll length is determined on the basis of the manageable weight of a roll. The thickness of the geonet is based on the slot dimensions of the opposing halves of the counter-rotating mold. Thicknesses of commercially available geonets vary between 4.0 and 6.9 mm (160 - 270 mils).

Most of the commercially available resins used for geonets are polyethylene in the natural density range of 0.934 to 0.940 g/cc. Thus they are classified as medium density polyethylene according to ASTM D-1248. The final compound is approximately 97% polyethylene. An additional 2 to 3% is carbon black, added as a powder or as a concentrate, and the remaining 0.5 to 1.0% are additives. The additives are added as a powder as are antioxidants and processing aids, both of which are proprietary to the various geonet manufacturers. Formulations are often the same as for HDPE geomembranes (recall Chapter 3), or slight variations thereof.

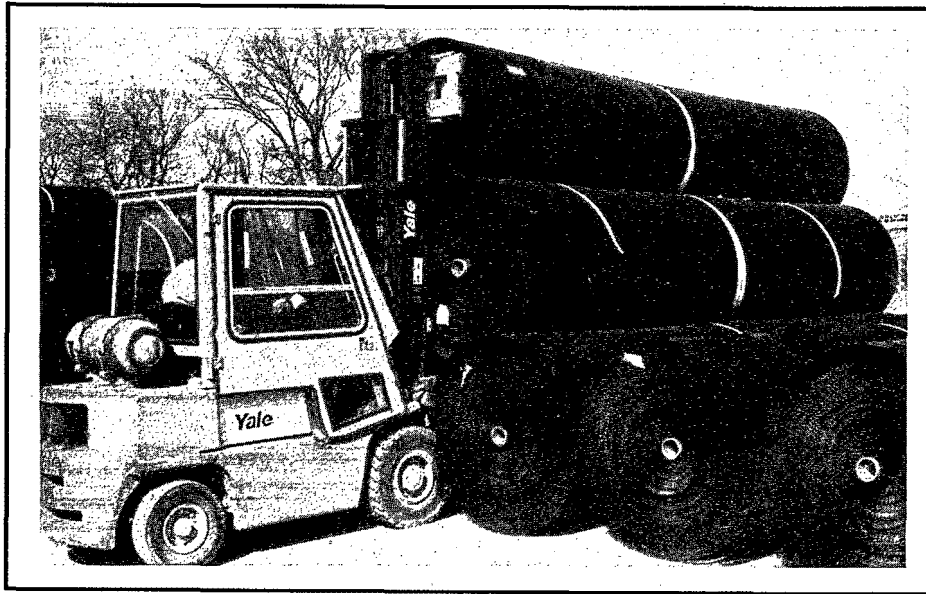

(a) Rolls of Drainage Geonets

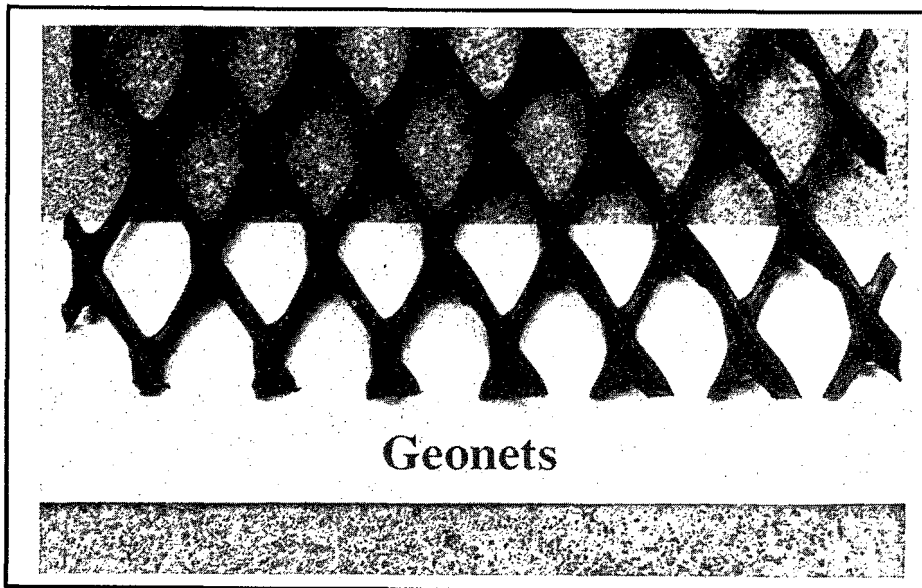

(b) Closeup of Rib Intersection

Figure 6.8 - Typical Geonets Used in Waste Containment Facilities

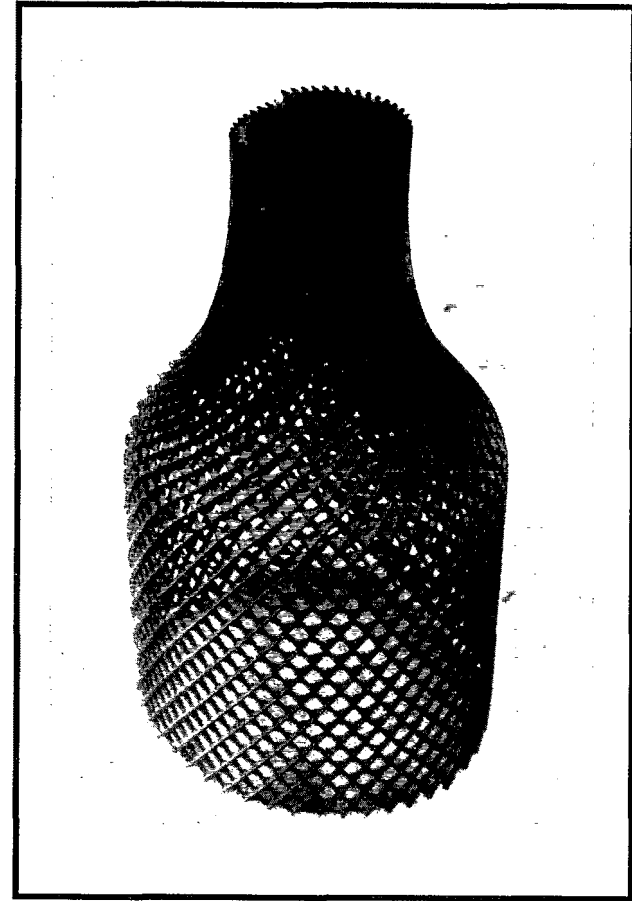
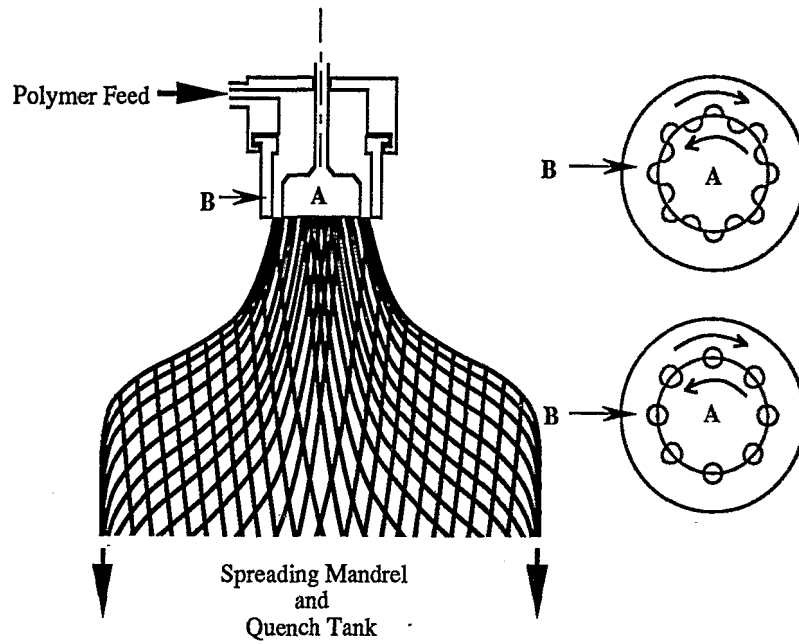

Figure 6.9 - Counter Rotating Die Technique (Left Sketch) for Manufacturing Drainage Geonets and Example of Laboratory Prototype (Right Photograph)

Regarding the preparation of a specification or MQA document for the resin component of HDPE geonets, the following items should be considered:

1. Specifications may call for the polyethylene resin to be made from virgin, uncontaminated ingredients. Alternatively, geonets can be made with off-spec geomembrane material as a large, or even major part, of their total composition provided this material is of the same formulation as the intended geonet and does not consist of recycled and/or reclaimed material. Recycled and/or reclaimed material is generally not allowed. It is acceptable, and is almost always the case, that the density of the resin is in the medium density range for polyethylene, i.e., that its density is equal to or less than 0.940 g/cc.
2. Typical quality control tests on the resin are density, via ASTM D-1505 or D-792 and melt flow index via ASTM D-1238.
3. An HDPE geonet formulation should consist of at least 97% of polyethylene resin, with the balance being carbon black and additives. No fillers, extenders, or other materials should be mixed into the formulation.
4. It should be noted that by adding carbon black and additives to the resin, the density of the final formulation is generally over 0.941 g/cc. Since this value is in the high density polyethylene category, according to ASTM D-1248, geonets of this type are customarily referred to as high density polyethylene (HDPE).
5. Regrind or reworked polymer which is previously processed HDPE geonet in chip form, is often added to the extruder during processing. It is acceptable if it is the same formulation as the geonet being produced.
6. No amount of "recycled" or "reclaimed" material, which has seen prior use in another product should be added to the formulation.
7. An acceptable variation of the process just described is to add a foaming agent into the extruder which then is processed in the standard manner. As the geonet is formed and is subsequently quenched, the foaming agent expands within the ribs creating innumerable small spherical voids. The voids are approximately 0.01 mm (0.5 mil) in diameter. This type of geonet is called a "foamed rib" geonet, in contrast to the standard type which is a "solid rib" geonet. Foamed rib geonets are currently seen less frequently in drainage systems than previously.
8. Quality control certificates from the manufacturer should include proper identification of the product and style and results of quality control tests.
9. The frequency of performing each of the preceding tests should be covered in the MQC plan and it should be implemented and followed.

6.3.2 Handling of Geonets

A number of activities occur between the manufacture of geonets and their final positioning where intended at the waste facility. These activities involve packaging, storage at the manufacturing facility, shipment, storage at the site, acceptance and conformance testing and final placement at the facility. Each of these topics will be described in this section.

6.3.2.1 Packaging

As geonets come from the quenching tank they are wound on a core until the desired length is reached. The geonet is then cut along its width and the entire roll contained by polymer straps so as not to unwind during subsequent handling. There is generally no protective wrapping placed around geonets, however, a plastic wrapping can be provided if necessary.

Specifications or a MQA document should be formed around a few important points.

1. The core must be stable enough to support the geonet roll while it is handled by either slings around it, or from a fork lift "stinger" inserted in it.
2. The core should have a minimum 100 mm (4.0 in.) inside diameter.
3. The banding straps around the outside of the roll should be made from materials with adequate strength yet should not damage the outer wrap(s) of the roll.

6.3.2.2 Storage at Manufacturing Facility

The storage of geonet rolls at the manufacturer's facility is similar to that described for HDPE geomembranes. Refer to Section 3.3.1 for a complete description.

6.3.2.3 Shipment

The shipment of geonet rolls from the manufacturer's facility to the project site is similar to that described for HDPE geomembranes. Refer to Section 3.3.2 for a complete description.

6.3.2.4 Storage at the Site

The storage of geonet rolls at the project site is similar to that described with HDPE geomembranes. Refer to section 3.3.2 for a complete description, see Fig. 6.10. An important exception is that a ground cloth should be placed under the geonets if they are stored on soil for any time longer than one month. This is to prevent weeds from growing into the lower rolls of the geonet. If weeds do grow in the geonet during storage, the broken pieces must be removed by hand on the job when the geonet is deployed.

6.3.2.5 Acceptance and Conformance Testing

The acceptance and conformance testing of geonets is similar to that described for HDPE geomembranes. Refer to Section 3.3.3 for a complete description. For geonets, the usual conformance tests are the following:

- density, per ASTM D-1505 or D-792
- mass per unit area, per ASTM D-5261
- thickness, per ASTM D-5199

Additional conformance tests such as compression per ASTM D-1621 and transmissivity per ASTM D-4716 may also be stipulated.



Figure 6.10 - Geonets Being Temporarily Stored at the Job Site

6.3.2.6 Placement

The placement of geonets in the field is similar to that described for geotextiles. Refer to Section 6.2.2.6 for a complete description.

6.3.3 Joining of Geonets

Geonets are generally joined together by providing a stipulated overlap and using plastic fasteners or polymer braid to tie adjacent ribs together at minimum intervals, see Fig. 6.11.

Recommended items for a specification or CQA document on the joining of geonets include the following:

1. Adjacent roll edges of geonets should be overlapped a minimum distance. This is typically 75-100 mm (3-4 in.).
2. The roll ends of geonets should be overlapped 150-200 mm (6-8 in.) since flow is usually in the machine direction.



Figure 6.11 - Photograph of Geonet Joining by Using Plastic Fasteners

3. All overlaps should be joined by tying with plastic fasteners or polymeric braid. Metallic ties or fasteners are not allowed.
4. The tying devices should be white or yellow, as contrasted to the black geonet, for ease of visual inspection.
5. The tying interval should be specified. Typically tie intervals are every 1.5 m (5.0 ft) along the edges and every 0.15 m (6.0 in.) along the ends and in anchor trenches.
6. Horizontal seams should not be allowed on side slopes. This requires that the length of the geonet should be at least as long as the side slope, anchor trench and a minimum run out at the bottom of the facility. If horizontal seams are allowed, they should be staggered from one roll to the adjacent roll.
7. In difficult areas, such as corners of side slopes, double layers of geonets are sometimes used. This should be stipulated in the plans and specifications.
8. If double geonets are used, they should be layered on top of one another such that interlocking does not occur.

9. If double geonets are used, roll edges and ends should be staggered so that the joints do not lie above one another.
10. Holes or tears in the geonet should be repaired by placing a geonet patch extending a minimum of 0.3 m (12 in.) beyond the edges of the hole or tear. The patch should be tied to the underlying geonet at 0.15 m (6.0 in.) spacings.
11. Holes or tears along more than 50% of the width of the geonet on side slopes should require the entire length of geonet to be removed and replaced.

6.3.4 Geonet/Geotextile Geocomposites

Geonets are always covered with either a geomembrane or a geotextile, i.e., they are never directly soil covered since the soil particles would fill the apertures of the geonet rendering it useless. Many geonets have a geotextile bonded to one, or both, surfaces. These are then referred to as geocomposites in the geonet manufacturer's literature. In this document, however, geocomposites will refer to many different types of drainage core structures. Clearly, covered geonets are included in this group. However, geocomposites also consist of fluted, nubbed and cusped cores, covered with geotextiles and/or geomembranes and will be described separately in section 6.4. Still further, some manufacturers refer to the entire group of geosynthetic drainage materials as "geospacers".

Regarding a specification or CQA document for geonet/geotextile drainage geocomposites, a few comments are offered:

1. The geotextile(s) covering a geonet should be bonded together in such a way that neither component is compromised to the point where proper functioning is impeded. Thus adequate, but not excessive, bonding of the geotextile(s) to the geonet is necessary.
2. If bonding is by heating, the geotextile(s) strength cannot be compromised to the point where failure could occur. The transmissivity under load test, ASTM D-4716, should be performed on the intended geocomposite product.
3. If bonding is by adhesives, the type of adhesive must be identified, including its water solubility and organic content. Excessive adhesive cannot be used since it could fill up some of the geonet's void space. The transmissivity under load test, ASTM D-4716, should be performed on the intended geocomposite product. The geotextile's permittivity could be evaluated using ASTM D-4491.
4. If the shear strength of the geotextile(s) to the geonet is of concern an adapted form of an interface shear test, e.g., ASTM D-5321, can be performed with the geotextile firmly attached to a wooden substrate, or other satisfactory arrangement. Alternatively, a ply adhesion test may be adequate, see ASTM D-413 which might be suitably modified for geotextile-to-geonet adhesion.
5. For factory fabricated geocomposites with geotextiles placed on both sides of a geonet, the geonet must be free from all dirt, dust and accumulated debris before covering.

6. For field placed geotextiles, the geonet should be free of all soil, dust and accumulated debris before covering with a geomembrane or geotextile. In extreme cases this may require washing of the geonet to accumulate the particulate material at the low end (sump) area where it is subsequently removed by hand.
7. When placing geosynthetic clay liners (GCLs) above geocomposites, cleanliness is particularly important in assuring that fugitive bentonite clay particles do not find their way into the geonet.
8. Placement of a covering geomembrane should not shift the geotextile or geocomposite out of position nor damage the underlying geonet.
9. An overlying geomembrane or geotextile should not be deployed such that excess tensile stress is mobilized in the geocomposite.

6.4 Other Types of Geocomposites

Geocomposite drainage systems consist of a polymer drainage core protected by a geotextile acting as both a filter and a separator to the adjacent material. Thus a geonet, with a geotextile attached to one surface or to both surfaces as described in section 6.3.4, is indeed a drainage geocomposite. However, for the drainage geocomposites discussed in this section the geotextile filter is always attached to the drainage core and the core can take a wide variety of non-geonet shapes and configurations. In some cases, the geotextile is only on one side of the core (the side oriented toward the inflowing liquid), in other cases it is wrapped completely around the drainage core.

There are three different types of drainage geocomposites referred to in this document; sheet drains, edge drains and strip (or wick) drains. Typical variations are shown in Fig. 6.12. For drainage systems associated with waste containment facilities, sheet drains, Fig. 6.12a, are sometimes used as surface water collectors and drains in cover systems of closed landfills and waste piles, refer to Fig. 6.1. Infiltration water that moves within the cover soil enters the sheet drain and flows gravitationally to the edge of the site (or cell) where it is generally collected by a perforated pipe, or edge drain. Pipes will be discussed separately in Chapter 8. The other possible use for sheet drains is for primary leachate collection systems in landfills. The required flow rate in some landfills is too great for a geonet, hence the greater drainage capacity of a geocomposite is sometimes required. Of course, when used in this application the drainage geocomposite must resist the compressive and shear stresses imposed by the waste and it must be chemically resistant to the leachate, but these are design considerations. The use of strip (wick) drains, Fig. 6.12b, in waste containment has been as vertical drains within a solid waste landfill to promote leachate communication between individual lifts. The edge drains, shown in Fig. 6.12(c), have potential applicability around the perimeter of a closed landfill facility to accumulate the surface water coming from a cap/closure system. A variety of perimeter drains could utilize such geocomposite edge drains.

Of the different types of drainage geocomposites shown in Fig. 6.12, only sheet drains will be described since they have the greatest applicability in waste containment systems.

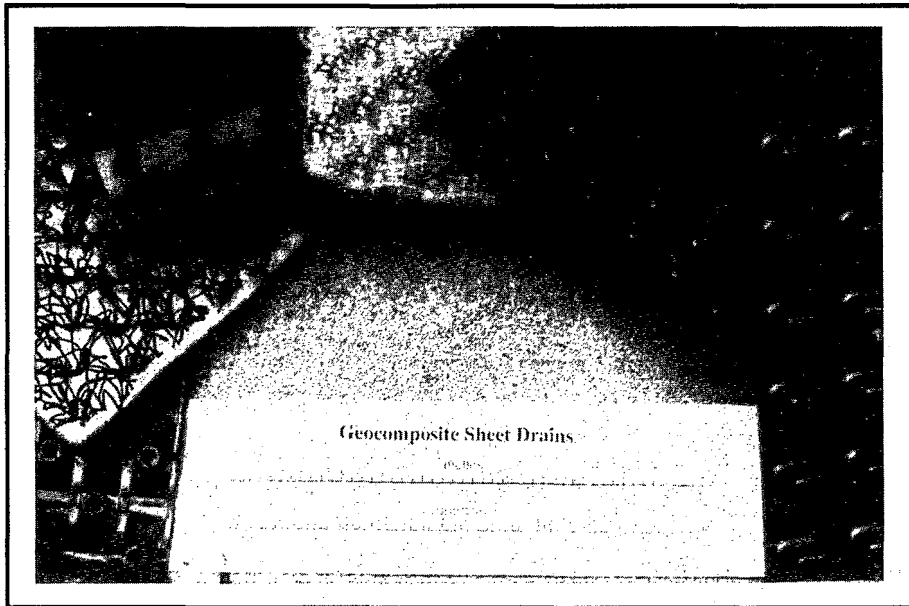

(a) Geocomposite Sheet Drains

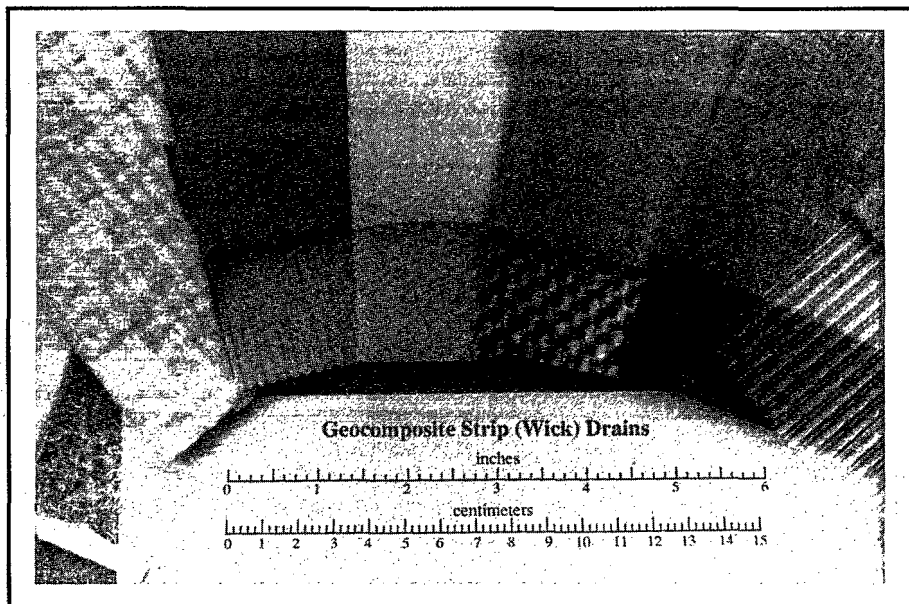

(b) Geocomposite Strip (Wick) Drains

Figure 6.12 - Various Types of Drainage Geocomposites (Continued on Next Page)

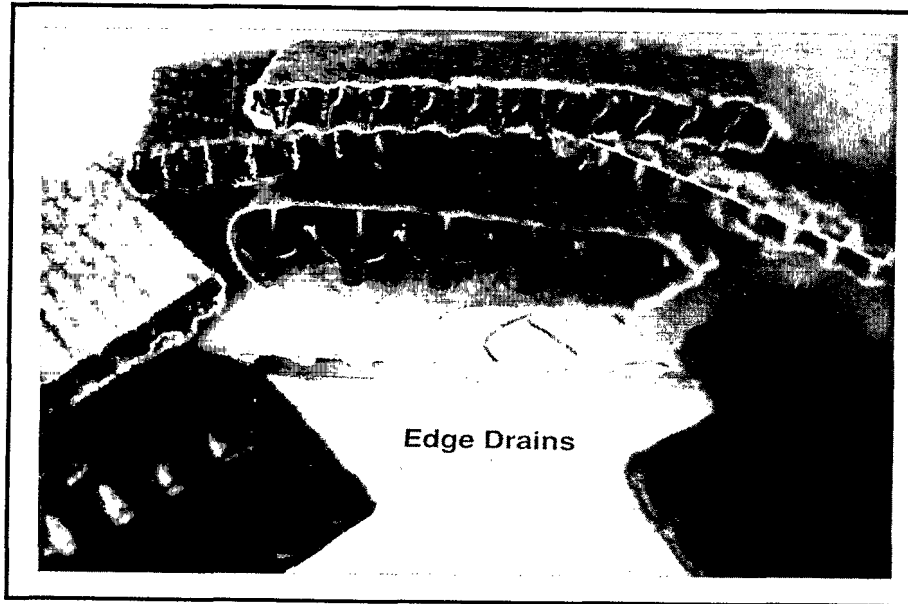

(c) Geocomposite Edge Drains

Figure 6.12 - Various Types of Drainage Geocomposites (Continued from Previous Page)

6.4.1 Manufacturing of Drainage Composites

The manufacture of the drainage core of a geocomposite sheet drain is generally accomplished by taking the desired type of polymer sheet and then vacuum forming dimples, protrusions or cuspatations which give rise to the protrusions. The polymer sheets of drainage geocomposites have been made from a wide variety of polymers. Commercial products that are currently available consist of the following polymer formulations:

- polystyrene
- nylon
- polypropylene
- polyvinyl chloride
- polyethylene
- polyethylene/polystyrene/polyethylene (coextrusion)

With coextrusion there exists a variety of possibilities in addition to those listed above. Recognize, however, that coarse fibers, entangled webs, filament matings, and many other variations are also possible.

Upon deciding on the proper type and thickness of polymer sheet, a geocomposite core usually goes through a vacuum forming step. In this step a vacuum draws portions of the polymer sheet into cusps at prescribed locations. Depending on the particular product, the protrusions are at 12 to 25 mm (0.5 to 1.0 in.) centers and are of a controlled depth and shape. Figure 6.13 shows a sketch of a vacuum forming system. In many of the systems the protrusions are tapered for ease in manufacturing during release of the vacuum and for a convenient male-to-female coupling of the edges and/or ends of the product in the field. The different types of drainage geocomposites are made in either continuous rolls or in discrete panels.

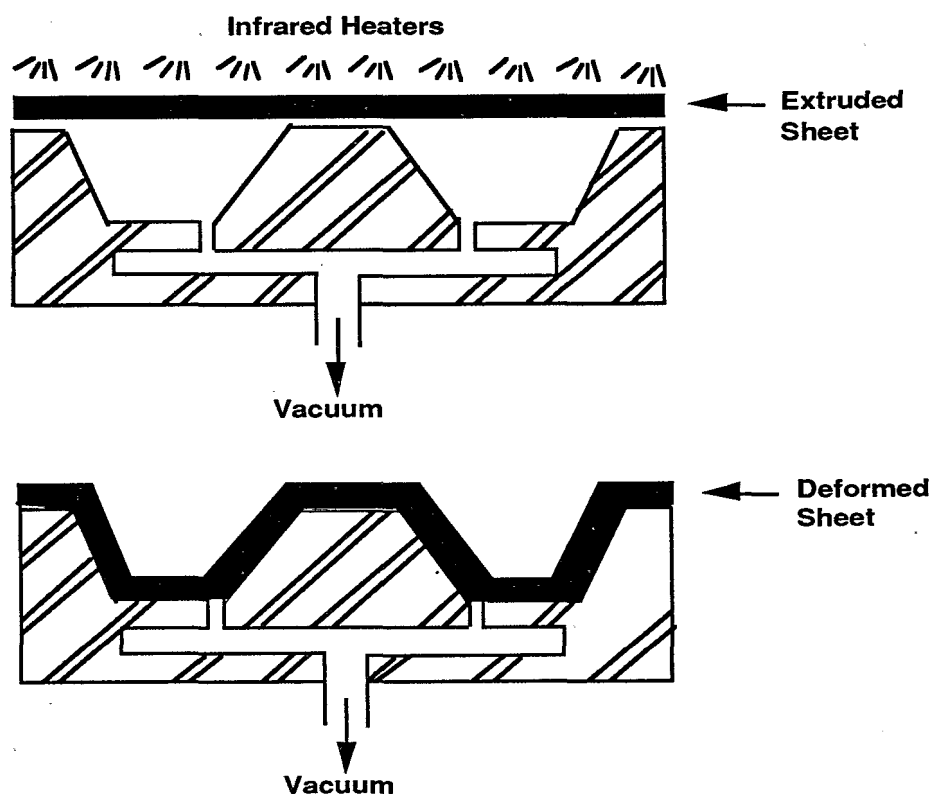

Figure 6.13 - Vacuum Forming System for Fabrication of a Drainage Geocomposite

The geotextile, which acts as both a filter to allow liquid into the drainage core and as a separator to keep soil out of the core by spanning from cusp to cusp is put onto the core as a secondary operation. Quite often an adhesive is placed on the tops of the cusps to adhere the geotextile to the core. Alternatively, heat bonding can be utilized. A variety of geotextiles can be

used and the site specific design will dictate the actual selection. As far as the MQA/CQA of the geotextile it is the same as was described in Section 6.2.

There are several items which should be included in a specification or MQA document for drainage geocomposite cores.

1. There should be verification and certification that the actual geocomposite core properties meet the manufacturers specification for that particular type and style.
2. Quality control certificates should include at a minimum, polymer composition, thickness of sheet per ASTM D-5199, height of raised cusps, spacing of cusps, compressive strength behavior (both strength and deformation values at core failure) per ASTM D-1621, and transmissivity using site specific conditions per ASTM D-4716.
3. For drainage systems consisting of coarse fibers, entangled webs and/or filament mattings the thickness under load per ASTM D-5199 and transmissivity under load per ASTM D-4716 are the main tests for QC purposes.
4. Values for each property should meet, or exceed, the manufacturers listed values or the project specification values, whichever are higher.
5. A statement indicating if, and to what extent, regrind polymer was added during manufacturing. No amount of reclaimed polymer should be allowed.
6. The frequency of performing each of the preceding tests should be covered in the MQC plans and it should be implemented and followed.

Additionally, there are several items which should be included in a specification or MQA document for the geotextile(s)/drainage core geocomposite.

1. The type of geotextile(s) should be identified and properly evaluated. See section 6.2 for these details.
2. For strip (wick) drains and edge drains, see Figs. 6.12(b) and (c) respectively, the geotextile completely surrounds the drainage core and generally no fixity is required. For sheet drains, Fig. 6.12(a), this is not the case.
3. The geotextile(s) covering of a drainage core should be bonded in such a way that neither component is compromised to the point where proper functioning is impeded. Thus adequate, but not excessive, bonding of the geotextile(s) to the drainage core is necessary.
4. If bonding is by heating, the geotextile(s) strength cannot be compromised to the point where failure could occur. The transmissivity under load test, ASTM D-4716, should be performed on the intended geocomposite product.
5. If bonding is by adhesives, the type of adhesive must be identified, including its water solubility and organic content. Excessive adhesive cannot be used since it could fill up some of the drainage core's void space. The transmissivity under load test, ASTM D-4716, should be performed on the intended geocomposite product. The geotextile's permittivity could be evaluated using ASTM D-4491.

6. If the shear strength of the geotextile(s) to the core is of concern an adapted form of an interface shear test, e.g., ASTM D-5321, can be performed with a wooden substrate, or other satisfactory arrangement. Alternatively, a ply adhesion test may be adequate, see ASTM D-413 which might be suitably modified for geotextile-to-core adhesion.
7. For factory fabricated geocomposites with geotextiles placed on both sides of the drainage core, the core must be free from all dirt, dust and accumulated debris before covering.

6.4.2 Handling of Drainage Geocomposites

A number of activities occur between the manufacture of drainage geocomposites and their final positioning where intended at the waste facility. These activities involve packaging, storage at the manufacturing facility, shipment, storage at the site, acceptance and conformance testing, and final placement at the facility. Each of these topics will be described although most will be by reference to the appropriate geotextile section.

6.4.2.1 Packaging

Usually a manufacturer will not attach the geotextile to the core until an order is received and shipment is imminent. Thus warehousing is not a major issue. The cores are either rolled onto themselves or are laid flat if they are in panel form. When an order is received, the geotextile is bonded to the core, the rolls are banded together with polymer straps and, if panels, they are banded in a similar manner.

6.4.2.2 Storage at Manufacturing Facility

Storage of the drainage cores at the manufacturing facility is usually not a major issue. The cores are generally stored indoors and are thus protected from atmospheric conditions.

6.4.2.3 Shipment

Shipment of drainage geocomposites (with the geotextile attached) is quite simple due to the light weight of these geosynthetics compared to other types. The text in Section 6.2.2.3 should be utilized, however, since accidental damage can always occur.

6.4.2.4 Storage at Field Site

The storage of drainage geocomposites at the project site is similar to that described for geotextiles, recall Section 6.2.2.4.

6.4.2.5 Acceptance and Conformance Testing

The acceptance and conformance testing of the geotextile portion of a drainage geocomposite is the same as described in Section 6.2.2.5. The acceptance and conformance testing of the core portion of a drainage geocomposite is project specific with the exception of the conformance tests themselves which are different. The recommended conformance tests for geocomposite drainage cores are the following:

- thickness of sheet per ASTM D-5199 or thickness of the geocomposite per ASTM D-5199

- thickness of raised cusps per ASTM D-1621
- spacing of raised cusps per ASTM D-1621

Optional conformance tests such as compression per ASTM D-1621 and transmissivity per ASTM D-4716 may also be stipulated. The frequency of conformance tests of the drainage core must be stipulated. In general, one test per 5,000 m² (50,000 ft²) should be the minimum test frequency.

6.4.2.6 Placement

The placement of drainage geocomposites in the field is similar to that described for geotextiles. Refer to Section 6.2.2.6 for details.

6.4.3 Joining of Drainage Geocomposites

Drainage geocomposites are usually joined together by folding back the geotextile from the lower core and inserting it into the bottom void space of the upper core, see Fig. 6.14. Where this is not possible a tab should be available at the edges of the core material for the purpose of overlapping. The geotextile must be refolded over the connection area assuring a complete covering of the core surface.

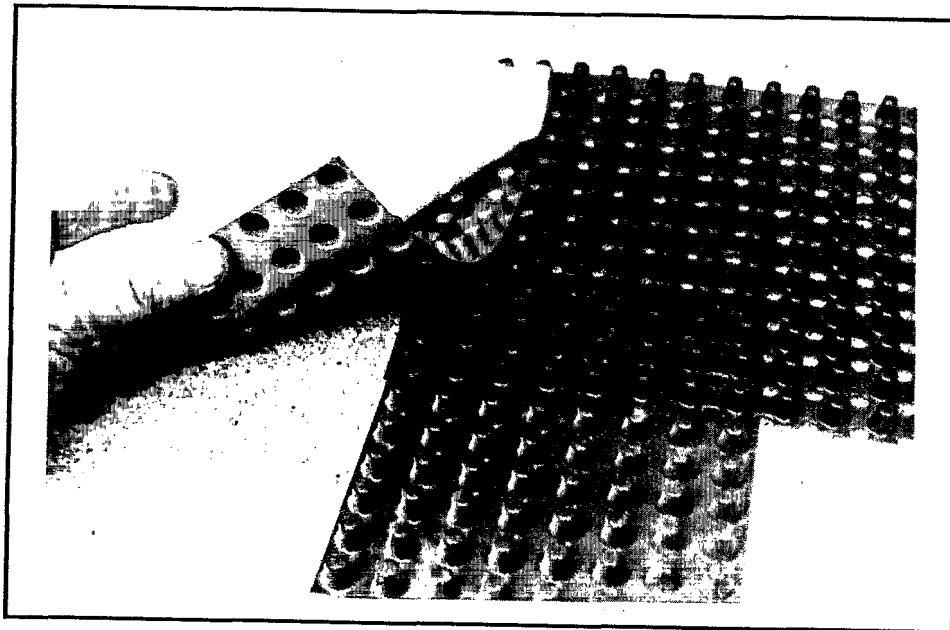

Figure 6.14 - Photograph of Drainage Core Joining via Male-to-Female Interlock

Recommended items for a specification or CQA document on the joining of drainage geocomposites include the following:

1. Adjacent edges of drainage cores should be overlapped for at least two rows of cusps.
2. The ends of drainage cores (in the direction of flow) should be overlapped for at least four rows of cusps.
3. The geotextiles covering the joined cores must provide a complete seal against backfill soil entering into the core.
4. Horizontal seams should not be allowed on sideslopes. This requires that the drainage geocomposite be provided in rolls which are at least as long as the side slope.
5. Holes or tears in drainage cores are repaired by placing a patch of the same type of material over the damaged area. The patch should extend at least four cusps beyond the edges of the hole or tear.
6. Holes or tears of more than 50% of the width of the drainage core on side slopes should require the entire length of the drainage core to be removed and replaced.
7. Holes or tears in the geotextile covering the drainage core should be repaired as described in Section 6.2.3.3.

6.4.4 Covering

Drainage geocomposites, with an attached geotextile, are covered with either soil, waste or in some cases a geomembrane. Regarding a specification or CQA document some comments should be included.

1. The core of the drainage geocomposite should be free of soil, dust and accumulated debris before backfilling or covering with a geomembrane. In extreme cases this may require washing of the core to accumulate the particulate material to the low end (sump) area for removal.
2. Placement of the backfilling soil, waste or geomembrane should not shift the position of the drainage geocomposite nor damage the underlying drainage geocomposite, geotextile or core.
3. When using soil or waste as backfill on side slopes, the work progress should begin at the toe of the slope and work upward.

6.5 References

ASTM D-413, "Rubber Property-Adhesion to Flexible Substrate"

ASTM D-792, "Specific Gravity and Density of Plastics by Displacement"

ASTM D-1238, "Flow Rates of Thermoplastics by Extrusion Plastometer"

ASTM D-1248, "Polyethylene Plastics and Extrusion Materials"

- ASTM D-1505, "Density of Plastics by the Density-Gradient Technique"
- ASTM D-1603, "Carbon Black in Olefin Plastics"
- ASTM D-1621, "Compressive Properties of Rapid Cellular Plastics"
- ASTM D-3786, "Hydraulic Bursting Strength of Knitted Goods and Nonwoven Fabrics: Diaphragm Bursting Strength Tester Method"
- ASTM D-4354, "Sampling of Geosynthetics for Testing"
- ASTM D-4355, "Deterioration of Geotextiles from Exposure to Ultraviolet Light and Water (Xenon-Arc Type Apparatus)"
- ASTM D-4491, "Water Permeability of Geotextiles by Permittivity"
- ASTM D-4533, "Trapezoidal Tearing Strength of Geotextiles"
- ASTM D-4632, "Breaking Load and Elongation of Geotextiles (Grab Method)"
- ASTM D-4716, "Constant Head Hydraulic Transmissivity (In-Plane Flow) of Geotextiles and Geotextile Related Products"
- ASTM D-4751, "Determining the Apparent Opening Size of a Geotextile"
- ASTM D-4759, "Determining the Specification Conformance of Geosynthetics"
- ASTM D-4833, "Index Puncture Resistance of Geotextiles, Geomembranes and Related Products"
- ASTM D-4873, "Identification, Storage and Handling of Geosynthetics"
- ASTM D-4884, "Seam Strength of Sewn Geotextiles"
- ASTM D-5199, "Measuring Nominal Thickness of Geotextiles and Geomembranes"
- ASTM D-5261, "Measuring Mass Per Unit Area of Geotextiles"
- ASTM D-5321, "Determining the Coefficient of Soil and Geosynthetic or Geosynthetic and Geosynthetic Friction by the Direct Shear Method"
- Diaz, V. A. (1990), "The Seaming of Geosynthetics," IFAI Publ., St. Paul, MN, 1990.
- IFAI (1990), "A Design Primer: Geotextiles and Related Materials," Industrial Fabrics Association International, St. Paul, MN.

Chapter 7

Vertical Cutoff Walls

7.1 Introduction

Situations occasionally arise in which it is necessary or desirable to restrict horizontal movement of liquids with vertical cutoff walls. Examples of the use of vertical cutoff walls include the following:

1. Control of ground water seepage into an excavated disposal cell to maintain stable side slopes or to limit the amount of water that must be pumped from the excavation during construction (Fig. 7.1).
2. Control of horizontal ground water flow into buried wastes at older waste disposal sites that do not contain a liner (Fig. 7.2).
3. Provide a "seal" into an aquitard (low-permeability stratum), thus "encapsulating" the waste to limit inward movement of clean ground water in areas where ground water is being pumped out and treated (Fig. 7.3).
4. Long-term barrier to impede contaminant transport (Fig. 7.4).

Vertical walls are also sometimes used to provide drainage. Drainage applications are discussed in Chapters 5 and 6.

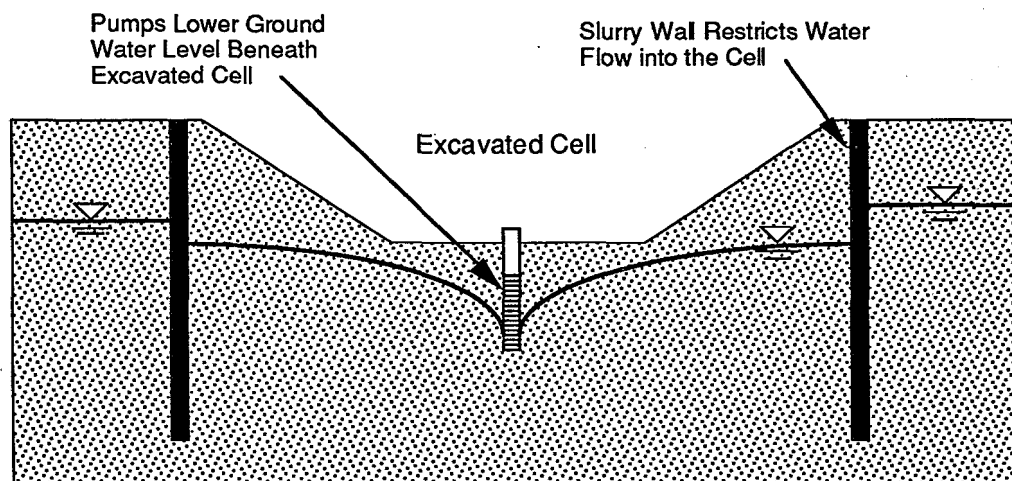

Figure 7.1 - Example of Vertical Cutoff Wall to Limit Flow of Ground Water into Excavation.

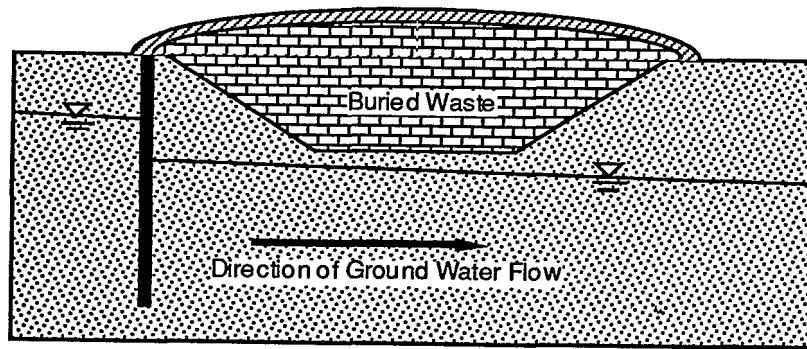

Figure 7.2 - Example of Vertical Cutoff Wall to Limit Flow of Ground Water through Buried Waste.

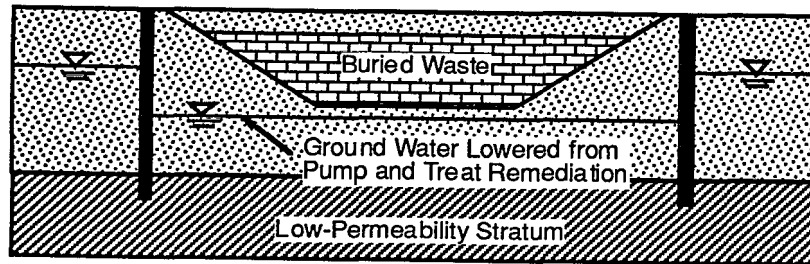

Figure 7.3 - Example of Vertical Cutoff Wall to Restrict Inward Migration of Ground Water.

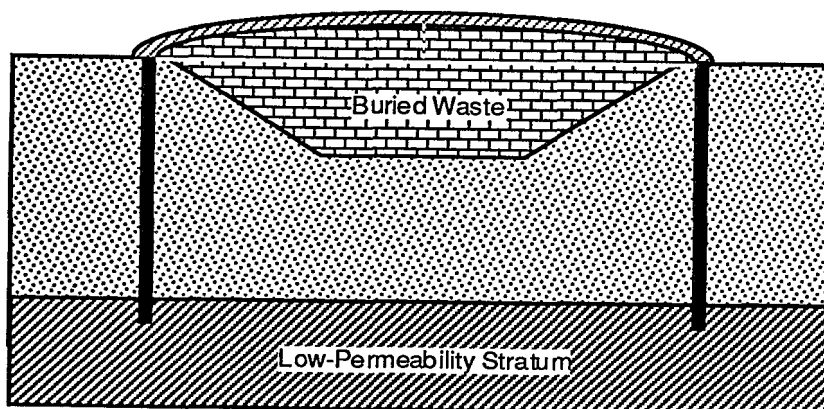

Figure 7.4 - Example of Vertical Cutoff Wall to Limit Long-Term Contaminant Transport.

7.2 Types of Vertical Cutoff Walls

The principal types of vertical cutoff walls are sheet pile walls, geomembrane walls, and slurry trench cutoff walls. Other techniques, such as grouting and deep soil mixing, are also possible, but have rarely been used for waste containment applications.

7.2.1 Sheet Pile Walls

Sheet pile walls are interlocking sections of steel or plastic materials (Fig. 7.5). Steel sheet piles are used for a variety of excavation shoring applications; the same type of steel sheet piles are used for vertical cutoff walls. Plastic sheet piles are a relatively recent development and are used on a limited basis for vertical cutoff walls. Sheet piles measure approximately 0.5 m (18 in.) in width, and interlocks join individual sheets together (Fig. 7.5). Lengths are essentially unlimited, but sheet piles are rarely longer than about 10 to 15 m (30 to 45 ft).

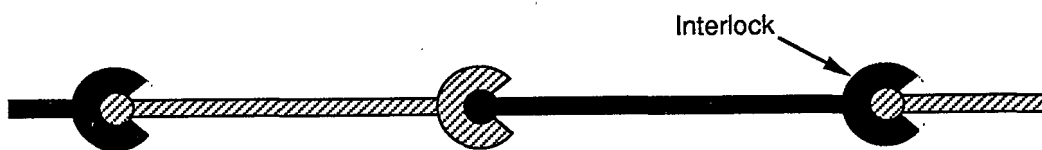

Figure 7.5 - Interlocking Steel Sheet Piles.

Plastic sheet piles are different from geomembrane panels, which are discussed later. Plastic sheet piles tend to be relatively thick-walled (wall thickness > 3 mm or $1/8$ in.) and rigid; geomembrane panels tend to have a smaller thickness (< 2.5 mm or 0.1 in.), greater width, and lower rigidity.

Sheet pile walls are installed by driving or vibrating interlocking steel sheet piles into the ground. Alternatively, plastic sheet piles can be used, but special installation devices may be needed, e.g., a steel driving plate to which the plastic sheet piles are attached. To promote a seal, a cord of material that expands when hydrated and attains a very low permeability may be inserted in the interlock. Other schemes have been devised and will continue to be developed for attaining a water-tight seal in the interlock.

Sheet pile walls have a long history of use for dewatering applications, particularly where the sheet pile wall is also used as a structural wall. Sheet pile walls also have been used on several occasions to cutoff horizontal seepage through permeable strata that underlie dams (Sherard et al., 1963).

Sheet pile walls have historically suffered from problems with leakage through interlocks, although much of the older experience may not be applicable to modern sheet piles with expanding material located in the interlock (the expandable material is a relatively recent development).

Leakage through sheet pile interlocks depends primarily on the average width of openings in the interlocking connections, the percentage of the interlocks that leak, and the quality and integrity of any sealant placed in the interlock. The sheet piles may be damaged during installation, which can create ruptures in the sheet pile material or separation of sheet piles at interlocks. Because of these problems, sheet pile cutoffs have not been used for waste containment facilities as extensively as some other types of vertical cutoff walls. Sheet pile walls are not discussed further in this report.

7.2.2 Geomembrane Walls

Geomembrane walls represent a relatively new type of vertical barrier that is rapidly gaining in popularity. The geomembrane wall consists of a series of geomembrane panels joined with special interlocks (examples of interlocks are sketched in Fig. 7.6) or installed as a single unit. If the geomembrane panels contain interlocks, a water-expanding cord is used to seal the interlock.

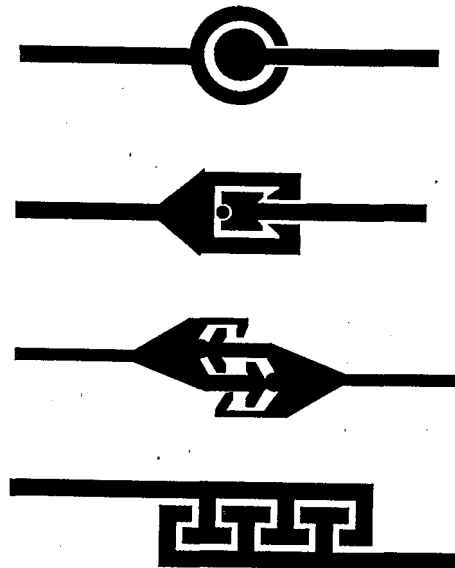

Figure 7.6 - Examples of Interlocks for Geomembrane Walls (Modified from Manassero and Pasqualini, 1992)

The technology has its roots in Europe, where slurry trench cutoff walls that are backfilled with cement-bentonite have been commonly used for several decades. One of the problems with cement-bentonite backfill, as discussed later, is that it is difficult to make the hydraulic conductivity of the cement-bentonite backfill less than or equal to 1×10^{-7} cm/s, which is often required of regulatory agencies in the U.S. To overcome this limitation in hydraulic conductivity and to improve the overall containment provided by the vertical cutoff wall, a geomembrane may be inserted into the cement-bentonite backfill. The geomembrane may actually be installed either in a slurry-filled trench or it may be installed directly into the ground using a special insertion plate.

7.2.3 Walls Constructed with Slurry Techniques

Walls constructed by slurry techniques (sometimes called "slurry trench cutoff walls") are described by Xanthakos (1979), D'Appolonia (1980), EPA (1984), Ryan (1987), and Evans (1993). With this technique, an excavation is made to the desired depth using a backhoe or clamshell. The trench is filled with a clay-water suspension ("mud" or "slurry"), which maintains stability of sidewalls via hydrostatic pressure. As the trench is advanced, the slurry tends to flow into the surrounding soil. Clay particles are filtered out, forming a thin skin of relatively impermeable material along the wall of the trench called a "filter cake." The filter cake has a very low hydraulic conductivity and allows the pressure from the slurry to maintain stable walls on the trench (Fig. 7.7). However, the level of slurry must generally be higher than the surrounding ground water table in order to maintain stability. If the water table is at or above the surface, a dike may be constructed to raise the surface elevation along the alignment of the slurry trench cutoff wall.

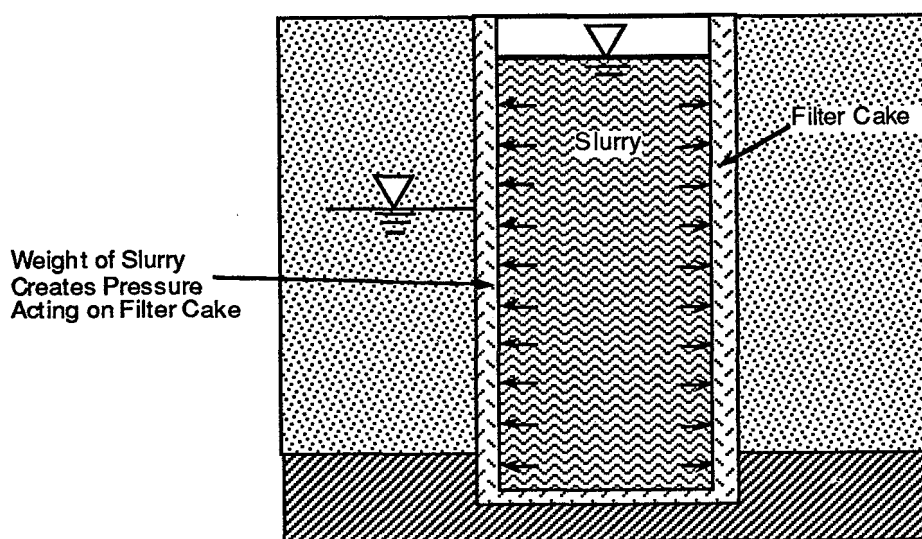

Figure 7.7 - Hydrostatic Pressure from Slurry Maintains Stable Walls of Trench.

In most cases, sodium bentonite is the clay used in the slurry. A problem with bentonite is that it does not gel properly in highly saline water or in some heavily contaminated ground waters. In such cases, an alternative clay mineral such as attapulgite may be used, or other special materials may be used to maintain a viscous slurry.

The slurry trench must either be backfilled or the slurry itself must harden into a stable material -- otherwise clay will settle out of suspension, the slurry will cease to support the walls of the trench, and the walls may eventually collapse. If the slurry is allowed to harden in place, the slurry is usually a cement-bentonite (CB) mixture. If the slurry trench is backfilled, the backfill is usually a soil-bentonite (SB) mixture, although plastic concrete may also be used (Evans, 1993).

In the U.S., slurry trenches backfilled with SB have been the most commonly used vertical cutoff trenches for waste containment applications. In Europe, the CB method of construction has been used more commonly. The reason for the different practices in the U.S. and Europe stems at least in part upon the fact that abundant supplies of high-quality sodium bentonite are readily available in the U.S. but not in Europe. Also, in most situations, SB backfill will have a somewhat lower hydraulic conductivity than cured CB slurry, and in the U.S. regulations have tended to drive the requirements for hydraulic conductivity to lower values than in Europe.

The construction sequence for a soil-bentonite backfilled trench is shown schematically in Fig. 7.8.

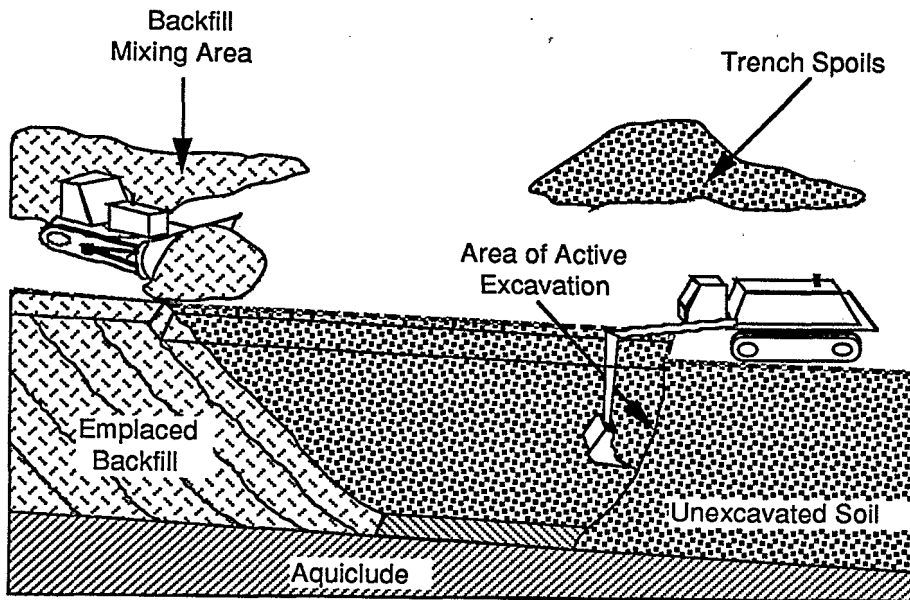

Figure 7.8 - Diagram of Construction Process for Soil-Bentonite-Backfilled Slurry Trench Cutoff Wall.

The main reasons why slurry trench cutoff walls are so commonly used for vertical cutoff walls are:

1. The depth of the trench may be checked to confirm penetration to the desired depth, and excavated materials may be examined to confirm penetration into a particular stratum;
2. The backfill can be checked prior to placement to make sure that its properties are as desired and specified;

3. The wall is relatively thick (compared to a sheet pile wall or a geomembrane wall);
4. There are no joints between panels or construction segments with the most common type of slurry trench cutoff wall construction.

In general, in comparison to sheet-pile walls, deep-soil-mixed walls, and grouted walls, there is more opportunity with a slurry trench cutoff wall to check the condition of the wall and confirm that the wall has been constructed as designed. In contrast, it is much more difficult to confirm that a sheet pile wall has been installed without damage, that grout has fully penetrated all of the desired pore spaces in the soil, or that deep mixing has taken place as desired.

7.3 Construction of Slurry Trench Cutoff Walls

The major construction activities involved in building a slurry cutoff wall are preconstruction planning and mobilization, preparation of the site, slurry mixing and hydration, excavation of soil, backfill preparation, placement of backfill, clean-up of the site, and demobilization. These activities are described briefly in the paragraphs that follow.

7.3.1 Mobilization

The first major construction activity is to make an assessment of the site and to mobilize for construction. The contractor locates the slurry trench cutoff wall in the field with appropriate surveys. The contractor determines the equipment that will be needed, amounts of materials, and facilities that may be required. Plans are made for mobilizing personnel and moving equipment to the site.

A preconstruction meeting between the designer, contractor, and CQA engineer is recommended. In this meeting, materials, construction procedures, procedures for MQA of the bentonite and CQA of all aspects of the project, and corrective actions are discussed (see Chapter 1).

7.3.2 Site Preparation

Construction begins with preparation of the site. Obstacles are removed, necessary relocations of utilities are made, and the surface is prepared. One of the requirements of slurry trench construction is that the level of slurry in the trench be greater than the level of ground water. If the ground water table is high, it may be necessary to construct a dike to ensure that the level of slurry in the trench is above the ground water level (Fig. 7.9). There may be grade restrictions in the construction specifications which will require some regrading of the surface or construction of dikes in low-lying areas. The site preparation work will typically also include preparation of working surfaces for mixing materials. Special techniques may be required for excavation around utility lines.

7.3.3 Slurry Preparation and Properties

Before excavation begins, as well as during excavation, the slurry must be prepared. The slurry usually consists of a mixture of bentonitic clay with water, but sometimes other clays such as attapulgite are used. If the clay is bentonite, the specifications should stipulate the criteria to be met, e.g., filtrate loss, and the testing technique by which the parameter is to be determined. The criteria can vary considerably from project to project.

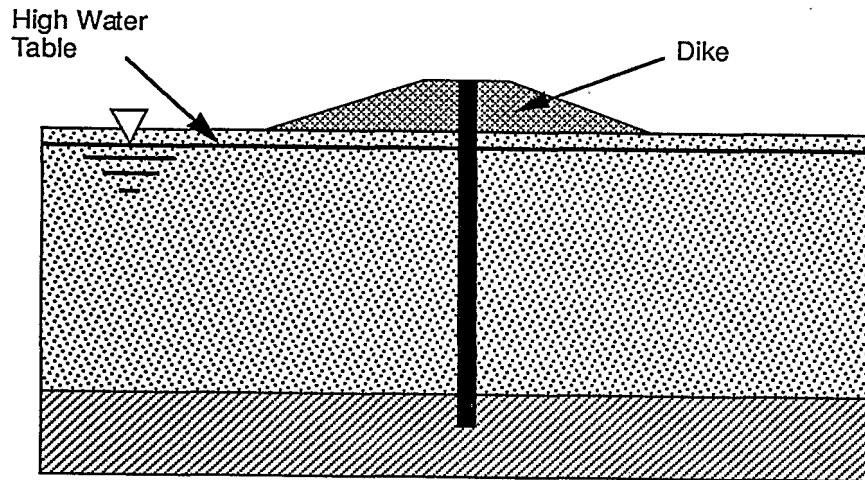

Figure 7.9 - Construction of Dike to Raise Ground Surface for Construction of Slurry Trench.

The clay may be mixed with water in either a batch or flash mixing operation. In the batch system specified quantities of water and bentonite are added in a tank and mixed at high speeds with a pump, paddle mixer, or other device that provides adequate high-speed colloidal shear mixing. Water and clay are mixed until hydration is complete and the desired properties of the slurry have been achieved. Complete mixing is usually achieved in a few minutes. The size of batch mixers varies, but typically a batch mixer will produce several cubic meters of mixed slurry at a time.

Flash mixing is achieved with a venturi mixer. With this system, bentonite is fed at a predetermined rate into a metered water stream that is forced through a nozzle at a constant rate. The slurry is subjected to high shear mixing for only a fraction of a second. The problem with this technique is that complete hydration does not take place in the short period of mixing. After the clay is mixed with water, the resulting slurry is tested to make sure the density and viscosity are within the requirements set forth in the CQA plan.

The mixed slurry may be pumped directly to the trench or to a holding pond or tank. If the slurry is stored in a tank or pond, CQA personnel should check the properties of the slurry periodically to make sure that the properties have not changed due to thixotropic processes or sedimentation of material from the slurry. The specifications for the project should stipulate mixing or circulation requirements for slurry that is stored after mixing.

The properties of the slurry used to maintain the stability of the trench are important. The following pertains to a bentonite slurry that will ultimately be displaced by soil-bentonite or other backfill; requirements for cement-bentonite slurry are discussed later in section 7.3.6. The slurry must be sufficiently dense and viscous to maintain stability of the trench. However, the slurry must not be too dense or viscous; otherwise, it will be difficult to displace the slurry when backfill is placed. Construction specifications normally set limits on the properties of the slurry. Typically about 4-8% bentonite by weight is added to fresh water to form a slurry that has a specific gravity of about 1.05 to 1.15. During excavation of the trench additional fines may become suspended in

the slurry, and the specific gravity is likely to be greater than the value of the freshly mixed slurry. The specific gravity of the slurry during excavation is typically on the order of 1.10 - 1.25.

The density of the slurry is measured with the procedures outlined in ASTM D-4380. A known volume of slurry is poured into a special "mud balance," which contains a cup on one end of a balance. The weight is determined and density calculated from the known volume of the cup.

The viscosity of the slurry is usually measured with a Marsh funnel. To determine the Marsh viscosity, fluid is poured into the funnel to a prescribed level. The number of seconds required to discharge 946 mL (1 quart) of slurry into a cup is measured. Water has a Marsh viscosity of about 26 seconds at 23°C. Freshly hydrated bentonite slurry should have a Marsh viscosity in the range of about 40 - 50 seconds. During excavation, the viscosity typically increases to as high as about 65 Marsh seconds. If the viscosity becomes too large the thick slurry must be replaced, treated (e.g., to remove sand), or diluted with additional fresh slurry.

The sand content of a slurry may also be specified. Although sand is not added to fresh slurry, the slurry may pick up sand in the trench during the construction process. The sand content by volume is measured with ASTM D-4381. A special glass measuring tube is used for the test. The slurry is poured onto a No. 200 sieve (0.075 mm openings), which is repeatedly washed until the water running through the sieve is clear. The sand is washed into the special glass measuring tube, and the sand content (volumetric) is read directly from graduation marks.

Other criteria may be established for the slurry. However, filtrate loss and density, coupled with viscosity, are the primary control variables. The specifications should set limits on these parameters as well as specify the test method. Standards of the American Petroleum Institute (1990) are often cited for slurry test methods. Limits may also be set on pH, gel strength, and other parameters, depending on the specific application.

The primary responsibility for monitoring the properties of the slurry rests with the construction quality control (CQC) team. The properties of the slurry directly affect construction operations but may also impact the final quality of the slurry trench cutoff wall. For example, if the slurry is too dense or viscous, the slurry may not be properly displaced by backfill. On the other hand, if the slurry is too thin and lacks adequate bentonite, the soil-bentonite backfill (formed by mixing soil with the bentonite slurry) may also lack adequate bentonite. The CQA inspectors may periodically perform tests on the slurry, but these tests are usually conducted primarily to verify test results from the CQC team. CQA personnel should be especially watchful to make sure that: (1) the slurry has a sufficiently high viscosity and density (if not, the trench walls may collapse); (2) the level of the slurry is maintained near the top of the trench and above the water table (usually the level must be at least 1 m above the ground water table to maintain a stable trench); and (3) the slurry does not become too viscous or dense (otherwise backfill will not properly displace the slurry).

7.3.4 Excavation of Slurry Trench

The slurry trench is excavated with a backhoe (Fig. 7.10) or a clam shell (Fig. 7.11). Long-stick backhoes can dig to depths of approximately 20 to 25 m (60 to 80 ft). For slurry trenches that can be excavated with a backhoe, the backhoe is almost always the most economical means of excavation. For trenches that are too deep to be excavated with a backhoe, a clam shell is normally used. The trench may be excavated first with a backhoe to the maximum depth of excavation that is achievable with the backhoe and to further depths with a clam shell. Special chopping, chiseling, or other equipment may be used as necessary. The width of the excavation tool is usually equal to the width of the trench and is typically 0.6 to 1.2 m (2 to 4 ft).

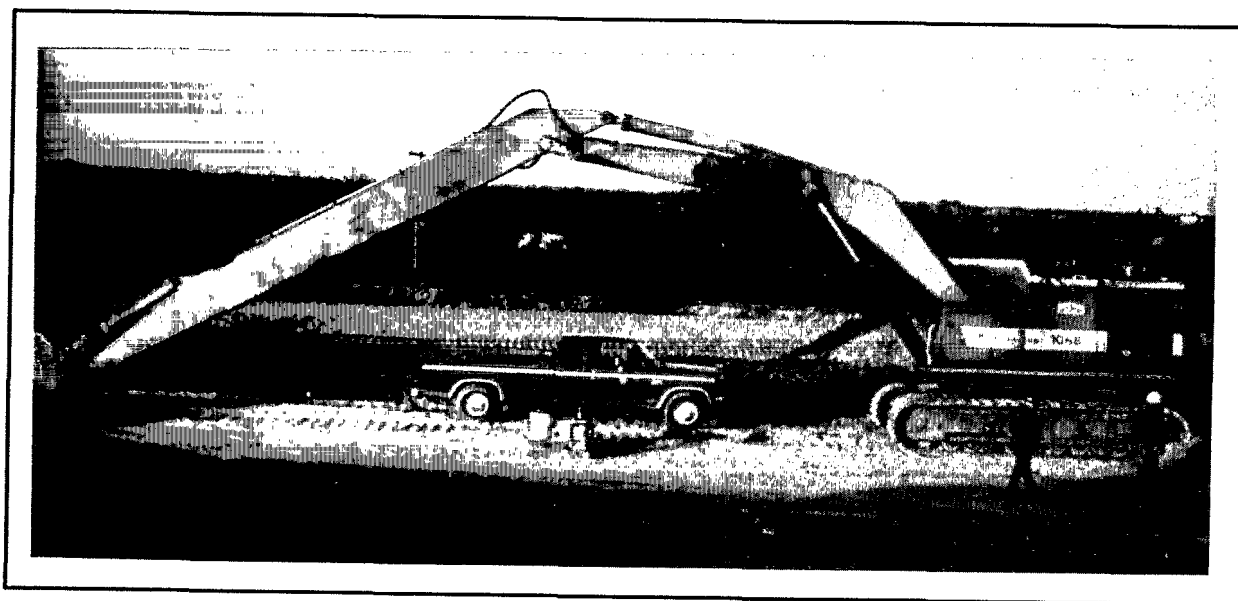

Figure 7.10 - Backhoe for Excavating Slurry Trench.

In most instances, the slurry trench cutoff wall is keyed into a stratum of relatively low hydraulic conductivity. In some instances, the vertical cutoff wall may be relatively shallow. For example, if a floating non-aqueous phase liquid such as gasoline is to be contained, the slurry trench cutoff wall may need to extend only a short distance below the water table surface, depending upon the site-specific circumstances. CQC/CQA personnel monitor the depth of excavation of the slurry trench and should log excavated materials to verify the types of materials present and to ensure specified penetration into a low-permeability layer. Monitoring normally involves examining soils that are excavated and direct measurement of the depth of trench by lowering a weight on a measuring tape down through the slurry. Additional equipment such as air lifts may be needed to remove sandy materials from the bottom of the trench prior to backfill.

7.3.5 Soil-Bentonite (SB) Backfill

Soil is mixed with the bentonite-water slurry to form soil-bentonite (SB) backfill. If the soil is too coarse, additional fines can be added. Dry, powdered bentonite may also be added, although it is difficult to ensure that the dry bentonite is uniformly distributed. In special applications in which the properties of the bentonite are degraded by the ground water, other types of clay may be used, e.g., attapulgite, to form a mineral-soil backfill. If possible, soil excavated from the trench is used for the soil component of SB backfill. However, if excavated soil is excessively contaminated or does not have the proper gradation, excavated soil may be hauled off for treatment and disposal.

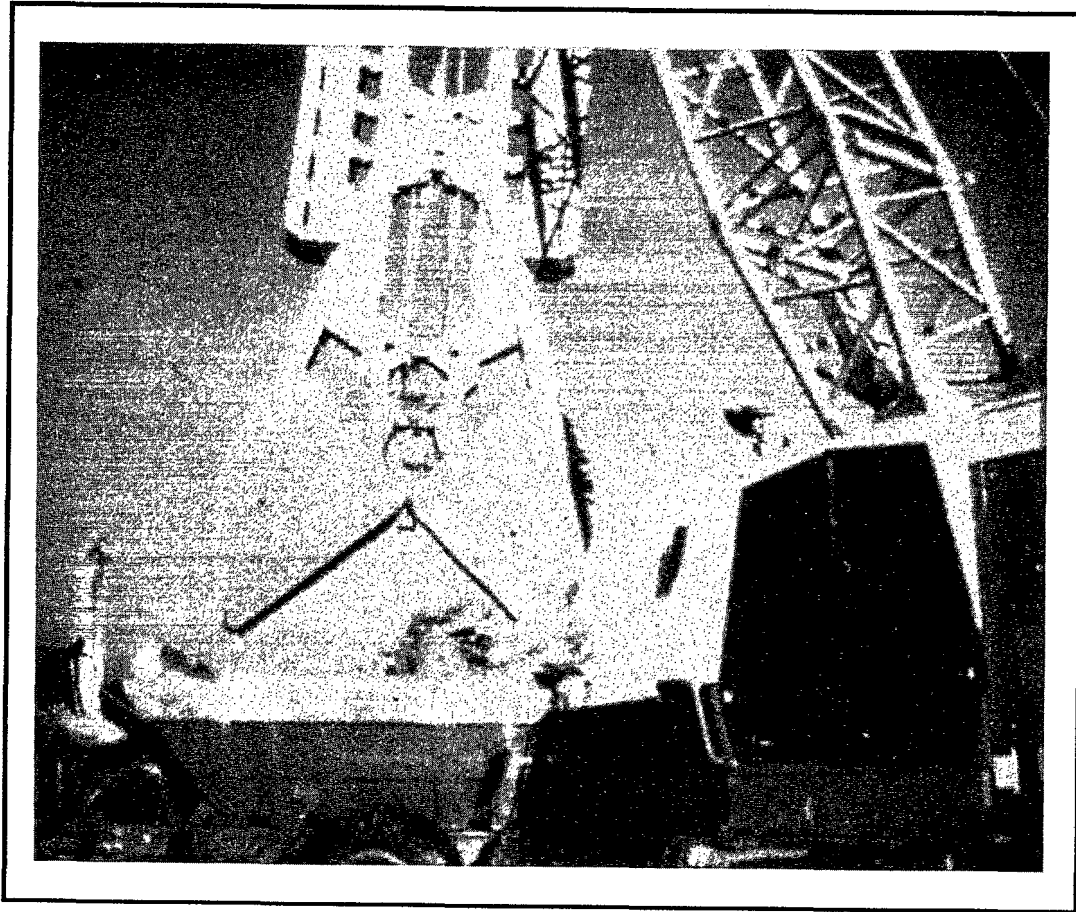

Figure 7.11. Clamshell for Excavating Slurry Trench.

Two parameters concerning the backfill are very important: (1) the presence of extremely coarse material (i.e., coarse gravel and cobbles), and (2) the presence of fine material. Coarse gravel is defined as material with particle sizes between 19 and 75 mm (ASTM D-2487). Cobbles are materials with particle sizes greater than 75 mm. Fine material is material passing the No. 200 sieve, which has openings of 0.075 mm. Cobbles will tend to settle and segregate in the backfill; coarse gravel may also segregate, but the degree of segregation depends on site-specific conditions. In some cases, the backfill may have to be screened to remove pieces that exceed the maximum size allowed in the specifications. The hydraulic conductivity of the backfill is affected by the percentage of fines present (D'Appolonia, 1980; Ryan, 1987; and Evans, 1993). Often, a minimum percentage of fines is specified. Ideally, the backfill material should contain at least 10 to 30% fines to achieve low hydraulic conductivity ($< 10^{-7}$ cm/s).

The bentonite may be added in two ways: (1) soil is mixed with the bentonite slurry (usually with a dozer, as shown in Fig. 7.12) to form a viscous SB material; and (2) additional dry powdered bentonite may be added to the soil-bentonite slurry mixture. Dry, powdered bentonite may or may not be needed. D'Appolonia (1980) and Ryan (1987) discuss many of the details of SB backfill design.



Figure 7.12 - Mixing Backfill with Bentonite Slurry.

When SB backfill is used, a more-or-less continuous process of excavation, preparation of backfill, and backfilling is used. To initiate the process, backfill is placed by lowering it to the bottom of the trench, e.g., with a clamshell bucket, or placing it below the slurry surface with a tremie pipe (similar to a very long funnel) until the backfill rises above the surface of the slurry trench at the starting point of the trench. Additional SB backfill is then typically pushed into the trench with a dozer (Fig. 7.13). The viscous backfill sloughs downward and displaces the slurry in the trench. As an alternative method to initiate backfilling, a separate trench that is not part of the final slurry trench cutoff wall, called a lead-in trench, may be excavated outside at a point outside of the limits of the final slurry trench and backfilled with the process just described, to achieve full backfill at the point of initiation of the desired slurry trench.



Figure 7.13 - Pushing Soil-Bentonite Backfill Into Slurry Trench with Dozer.

After the trench has been backfilled, low hydraulic conductivity is achieved via two mechanisms: (1) the SB backfill itself has low hydraulic conductivity (typical design value is $\leq 10^{-7}$ cm/s), and (2) the filter cake enhances the overall function of the wall as a barrier. Designers do not normally count on the filter cake as a component of the barrier; it is viewed as a possible source of added impermeability that enhances the reliability of the wall.

The compatibility of the backfill material with the ground water at a site should be assessed prior to construction. However, CQA personnel should be watchful for ground water conditions that may differ from those assumed in the compatibility testing program. CQA personnel should familiarize themselves with the compatibility testing program. Substances that are particularly aggressive to clay backfills include non-water-soluble organic chemicals, high and low pH liquids, and highly saline water. If there is any question about ground water conditions in relationship to the conditions covered in the compatibility testing program, the CQA engineer and/or design engineer should be consulted.

Improper backfilling of slurry trench cutoff walls can produce defects (Fig. 7.14). More details are given by Evans (1993). CQA personnel should watch out for accumulation of sandy materials during pauses in construction, e.g., during shutdowns or overnight; an airlift can be used to remove or resuspend the sand, if necessary.

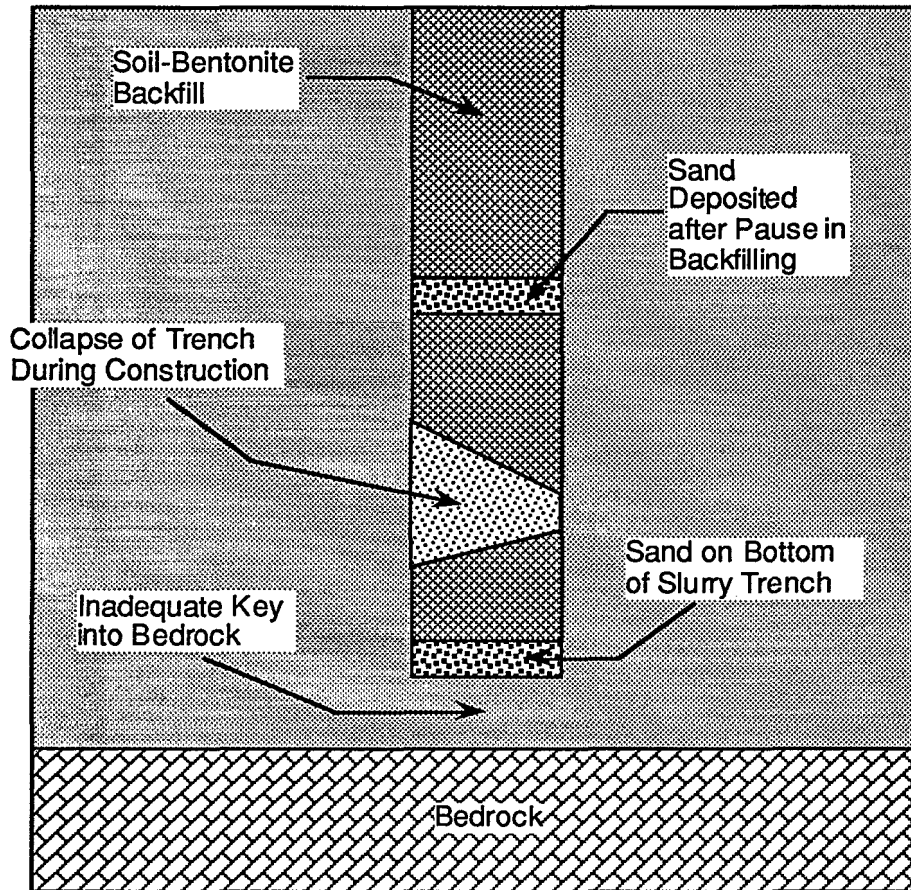

Figure 7.14 - Examples of Problems Produced by Improper Backfilling of Slurry Trench.

Some slurry trench cutoff walls fully encircle an area. As the slurry trench reaches the point of initiation of the slurry trench cutoff wall, closure is accomplished by excavating into the previously-backfilled wall.

Hydraulic conductivity of SB backfill is normally measured by testing of small cylinders of material formed from field samples. Ideally, a sample of backfill material is scooped up from the backfill, placed in a cylinder of a specified type, consolidated to a prescribed effective stress, and permeated. It is rare for borings to be drilled into the backfill to obtain samples for testing.

7.3.6 Cement-Bentonite (CB) Cutoff Walls

A cement-bentonite (CB) cutoff wall is constructed with a cement-bentonite-water mixture that hardens and attains low hydraulic conductivity. The slurry trench is excavated, and excavated soils are hauled away. Then the trench is backfilled in one of two ways. In the usual method, the slurry used to maintain a stable trench during construction is CB rather than just bentonite-water,

and the slurry is left in place to harden. A much-less-common technique is to construct the slurry trench with a bentonite-water slurry in discrete diaphragm cells (Fig. 7.15), and to displace the bentonite-water slurry with CB in each cell.

The CB mixture cures with time and hardens to the consistency of a medium to stiff clay (CB backfill is not nearly as strong as structural concrete). A typical CB slurry consists on a weight basis of 75 to 80% water, 15 to 20% cement, 5% bentonite, and a small amount of viscosity reducing material. Unfortunately, CB backfill is usually more permeable than SB backfill. Hydraulic conductivity of CB backfill is often in the range of 10^{-6} to 10^{-5} cm/s, which is about an order of magnitude or more greater than typical SB cutoff walls.

(A) Excavate Panels

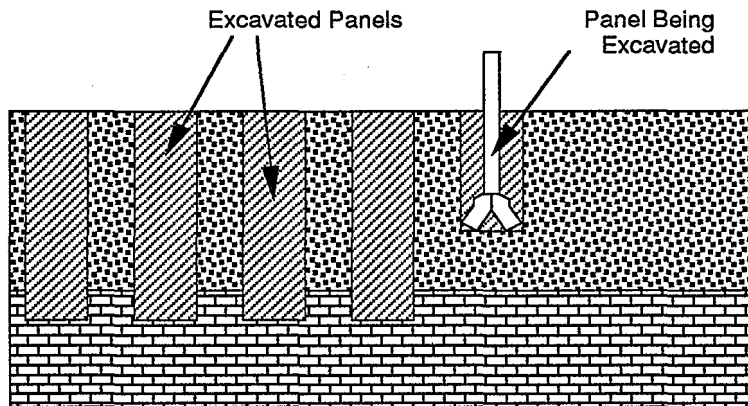

(B) Excavate Between Panels

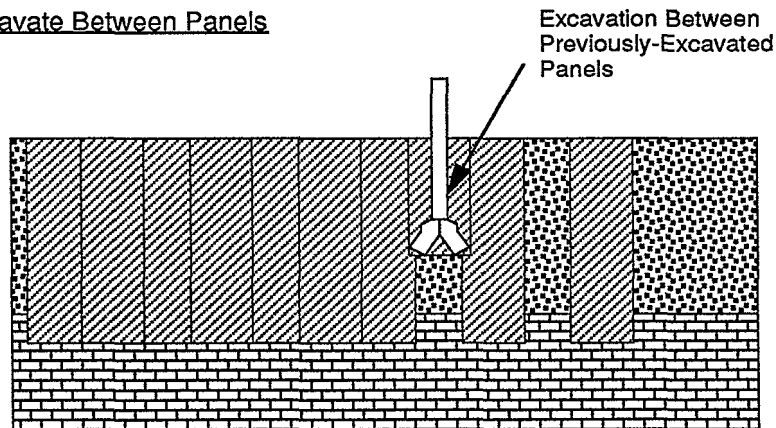

Figure 7.15 - Diaphragm-Wall Construction.

The CB cutoff wall is constructed using procedures almost identical to those employed in building structural diaphragm walls. In Europe, CB backfilled slurry trench cutoff walls are much more common than in the U.S., at least partly because the diaphragm-wall construction capability is more broadly available in Europe and because high-grade sodium bentonite (which is critical for soil-bentonite backfilled walls) is not readily available in Europe. In Europe, the CB often contains other ingredients besides cement, bentonite, and water, e.g., slag and fly ash.

7.3.7 Geomembrane in Slurry Trench Cutoff Walls

Geomembranes may be used to form a vertical cutoff wall. The geomembrane may be installed in one of at least two ways:

1. The geomembrane may be inserted in a trench filled with CB slurry to provide a composite CB-geomembrane barrier (Manassero and Pasqualini, 1992). The geomembrane is typically mounted to a frame, and the frame is lowered into the slurry. The base of the geomembrane contains a weight such that when the geomembrane is released from the frame, the frame can be removed without the geomembrane floating to the top. CQA personnel should be particularly watchful to ensure that the geomembrane is properly weighted and does not float out of position. Interlocks between geomembrane panels (Fig. 7.6) provide a seal between panels. The panels are typically relatively wide (of the order of 3 to 7 m) to minimize the number of interlocks and to speed installation. The width of a panel may be controlled by the width of excavated sections of CB-filled panels (Fig. 7.15).
2. The geomembrane may be driven directly into the CB backfill or into the native ground. Panels of geomembrane with widths of the order of 0.5 to 1 m (18 to 36 in.) are attached to a guide or insertion plate, which is driven or vibrated into the subsurface. If the panels are driven into a CB backfill material, the panels should be driven before the backfill sets up. Interlocks between geomembrane panels (Fig. 7.6) provide a seal between panels. This methodology is essentially the same as that of a sheet pile wall.

Although use of geomembranes in slurry trench cutoff walls is relatively new, the technology is gaining popularity. The promise of a practically impermeable vertical barrier, plus excellent chemical resistance of HDPE geomembranes, are compelling advantages. Development of more efficient construction procedures will make this type of cutoff wall increasingly attractive.

7.3.8 Other Backfills

Structural concrete could be used as a backfill, but if concrete is used, the material normally contains bentonite and is termed *plastic concrete* (Evans, 1993). Plastic concrete is a mixture of cement, bentonite, water, and aggregate. Plastic concrete is different from structural concrete because it contains bentonite and is different from SB backfill because plastic concrete contains aggregate. Other ingredients, e.g., fly ash, may be incorporated into the plastic concrete. Construction is typically with the panel method (Fig. 7.15). Hydraulic conductivity of the backfill can be $< 10^{-8}$ cm/s. High cost of plastic concrete limits its use.

A relatively new type of backfill is termed soil-cement-bentonite (SCB). The SCB wall uses native soils (not aggregates, as with plastic concrete). Placement is in a continuous trench rather than panel method.

7.3.9 Caps

A cutoff wall cap represents the final surface cap on top of the slurry trench cutoff wall. The cap may be designed to minimize infiltration, withstand traffic loadings, or serve other purposes. CQA personnel should also inspect the cap as well as the wall itself to ensure that the cap conforms with specification.

7.4 Other Types of Cutoff Walls

Evans (1993) discusses other types of cutoff walls. These include vibrating beam cutoff walls, deep soil mixed walls, and other types of cutoff walls. These are not discussed in detail here because these types of walls have been used much less frequently than the other types.

7.5 Specific COA Requirements

No standard types of tests or frequencies of testing have evolved in the industry for construction of vertical cutoff walls. Among the reasons for this is the fact that construction materials and technology are continually improving. Recommendations from this section were taken largely from recommendations provided by Evans (personal communication).

For slurry trench cutoff walls, the following comments are applicable. The raw bentonite (or other clay) that is used to make the slurry may have specific requirements that must be met. If so, tests should be performed to verify those properties. There are no standard tests or frequency of tests for the bentonite. The reader may wish to consult Section 2.6.5 for a general discussion of tests and testing frequencies for bentonite-soil liners. For the slurry itself, common tests include viscosity, unit weight, and filtrate loss, and other tests often include pH and sand content. The properties of the slurry are normally measured on a regular basis by the contractor's CQC personnel; CQA personnel may perform occasional independent checks.

The soil that is excavated from the trench should be continuously logged by CQA personnel to verify that subsurface conditions are similar to those that were anticipated. The CQA personnel should look for evidence of instability in the walls of the trench (e.g., sloughing at the surface next to the trench or development of tension cracks). If the trench is to extend into a particular stratum (e.g., an aquitard), CQA personnel should verify that adequate penetration has occurred. The recommended procedure is to measure the depth of the trench once the excavator has encountered the aquitard and to measure the depth again, after adequate penetration is thought to have been made into the aquitard.

After the slurry has been prepared, and CQC tests indicate that the properties are adequate, additional samples are often taken of the slurry from the trench. The samples are often taken from near the base of the trench using a special sampler that is capable of trapping slurry from the bottom of the trench. The unit weight is particularly important because sediment may collect near the bottom of the trench. For SB backfill, the slurry must not be heavier than the backfill. The depth of the trench should also be confirmed by CQA personnel just prior to backfilling. Often, sediments can accumulate near the base of the trench -- the best time to check for accumulation is just prior to backfilling. CQA personnel should be particularly careful to check for sedimentation after periods when the slurry has not been agitated, e.g., after an overnight work stoppage.

Testing of SB backfill usually includes unit weight, slump, gradation, and hydraulic conductivity. Bentonite content may also be measured, e.g., using the methylene blue test (Alther, 1983). Slump testing is the same as for concrete (ASTM C-143). Hydraulic conductivity testing is often performed using the API (1990) fixed-ring device for the filter press test. Occasional

comparative tests with ASTM D-5084 should be conducted. There is no widely-applied frequency of testing backfill materials.

7.6 Post Construction Tests for Continuity

At the present time, no testing procedures are available to determine the continuity of a completed vertical cutoff wall.

7.7 References

Alther, G. R. (1983), "The Methylene Blue Test for Bentonite Liner Quality Control," *Geotechnical Testing Journal*, Vol. 6, No. 3, pp. 133-143.

American Petroleum Institute (1990), *Recommended Practice for Standard Procedure for Field Testing Drilling Fluids*, API Recommended Practice 13-B-1, Dallas, Texas.

ASTM C-143, "Slump of Hydraulic Cement Concrete."

ASTM D-2487, "Classification of Soils for Engineering Purposes (Unified Soil Classification System)."

ASTM D-4380, "Density of Bentonitic Slurries."

ASTM D-4381, "Sand Content by Volume of Bentonite Slurries."

ASTM D-5084, "Measurement of Hydraulic Conductivity of Saturated Porous Materials Using a Flexible Wall Permeameter."

D'Appolonia, D. J. (1980), "Soil-Bentonite Slurry Trench Cutoffs," *Journal of Geotechnical Engineering*, Vol. 106, No. 4, pp. 399-417.

Evans, J. C. (1993), "Vertical Cutoff Walls," in *Geotechnical Practice for Waste Disposal*, D. E. Daniel (Ed.), Chapman and Hall, London, pp. 430-454.

Manassero, M., and E. Pasqualini (1992), "Ground Pollutant Containment Barriers," in *Environmental Geotechnology*, M.A. Usmen and Y.B. Acar (Eds.), A.A. Balkema, Rotterdam, pp. 195-204.

Ryan, C. R. (1987), "Soil-Bentonite Cutoff Walls," in *Geotechnical Practice for Waste Disposal '87*, R. D. Woods (Ed.), American Society of Civil Engineers, New York, pp. 182-204.

Sherard, J. L., Woodward, R. J., Gizienski, S. F., and W. A. Clevenger (1963), *Earth and Earth-Rock Dams*, John Wiley and Sons, Inc., New York, 725 p.

U.S. Environmental Protection Agency (1984), "Slurry Trench Construction for Pollution Migration Control," Office of Emergency and Remedial Response, Washington, DC, EPA-540/2-84-001.

Xanthakos, P. P. (1979), *Slurry Walls*, McGraw-Hill Book Company, New York, 822 p.

Chapter 8

Ancillary Materials, Appurtenances and Other Details

This chapter is devoted toward ancillary materials used within a waste containment facility, various appurtenances which are necessary for proper functioning of the system and other important details. Ancillary materials such as plastic pipe for leachate transmission, sumps for collection of leachate, manholes and pipe risers for removal of leachate will be covered in this chapter. Appurtenances, such as penetrations made through various barrier materials, will be covered. Lastly, other important details requiring careful inspection, such as anchor trenches, internal dikes and berms, and access ramps, will also be addressed.

8.1 Plastic Pipe (aka "Geopipe")

Whenever the primary or secondary leachate collection system at the bottom of a waste containment facility is a natural soil material, such as sand or gravel, a perforated piping system should be located within it to rapidly transmit the leachate to a sump and removal system. Figure 8.1 illustrates the cross section of such a pipe system which is generally located directly on top of the geomembrane or geotextile to 225 mm (9.0 in.) above the primary liner material. This is a design issue and the plans and specifications must be clear and detailed regarding these dimensions.

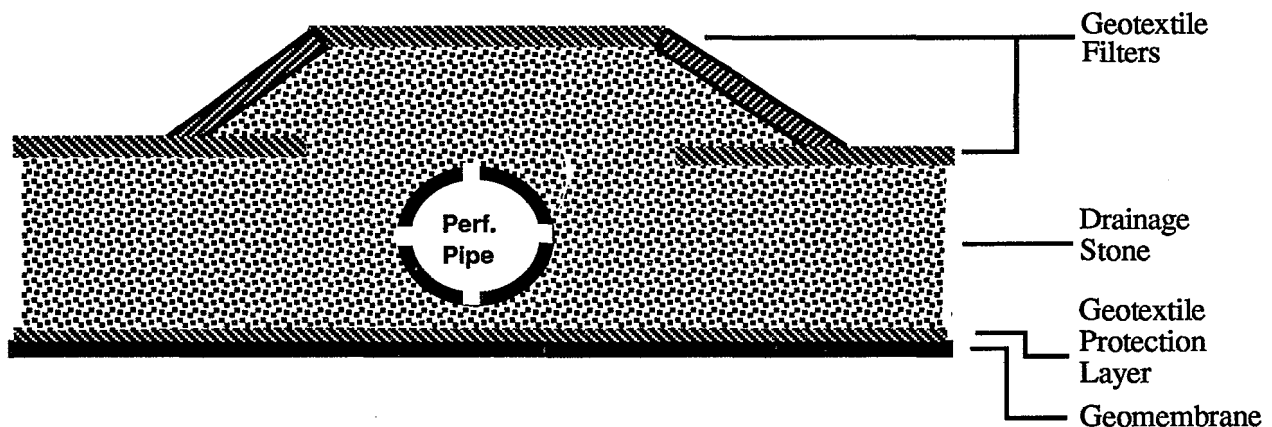

Figure 8.1 - Cross Section of a Possible Removal Pipe Scheme in a Primary Leachate Collection and Removal System (for illustration purposes only).

The pipes are sometimes placed in a manifold configuration with feeder lines framing into a larger main trunk line thus covering the entire footprint of the landfill unit or cell, see Fig. 8.2. The entire pipe network flows gravitationally to a low point where the sump and removal system

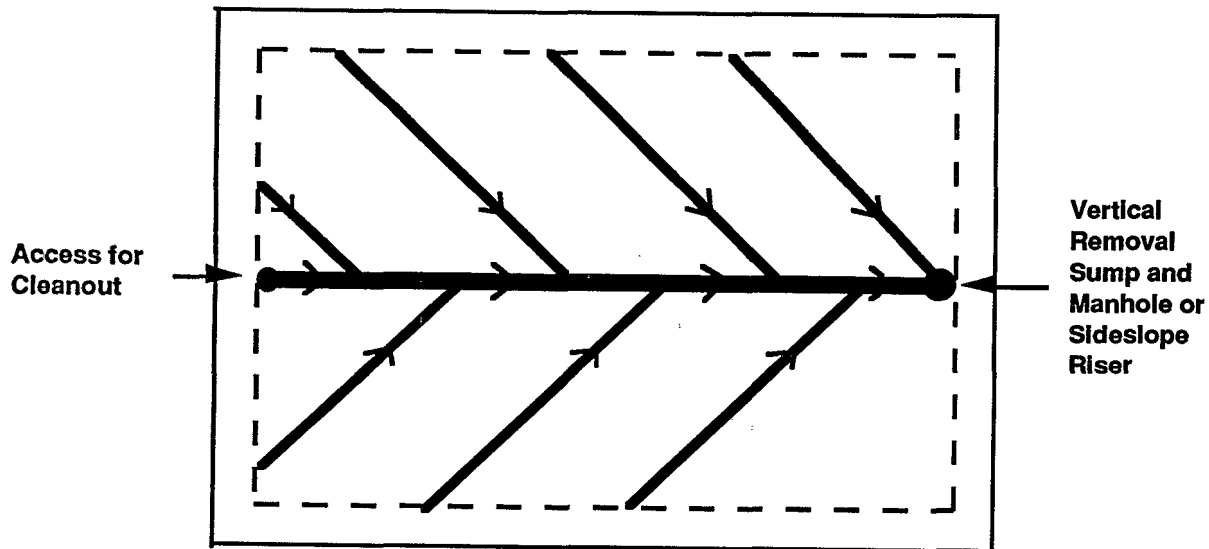

Figure 8.2 - Plan View of a Possible Removal Pipe Scheme in a Primary Leachate Collection and Removal System (for illustration purposes only).

consisting of either a manhole or pipe riser is located. The diagonal feeder pipes, if included, are always perforated to allow the leachate to enter into them. The central trunk lines may or may not be perforated depending on the site specific design. It must be recognized, however, that there is a large variety of schemes that are possible and it is clearly a design issue which must be unequivocally presented in the plans and specifications.

Leachate collection and transmission lines in most waste containment facilities are plastic pipe, with polyvinyl chloride (PVC) and high density polyethylene (HDPE) being the two major material types in current use. Furthermore, there are two types of HDPE pipe in current use, solid wall and corrugated types. Each of these types of plastic pipes will be described.

8.1.1 Polyvinyl Chloride (PVC) Pipe

Polyvinyl chloride (PVC) pipe has been used in waste containment systems for leachate collection and removal in a number of different locations and configurations. The pipes can be perforated or not depending on the site specific design. The pipes are often supplied in 6.1 m (20 ft) lengths which are joined by couplings or utilize bell and spigot ends. The PVC material typically consists of resin, fillers, carbon black/pigment and additives. PVC pipe does not contain any liquid plasticizers, see Fig. 8.3.

Regarding a specification or a MQA document for PVC pipe and fittings the following items should be considered.

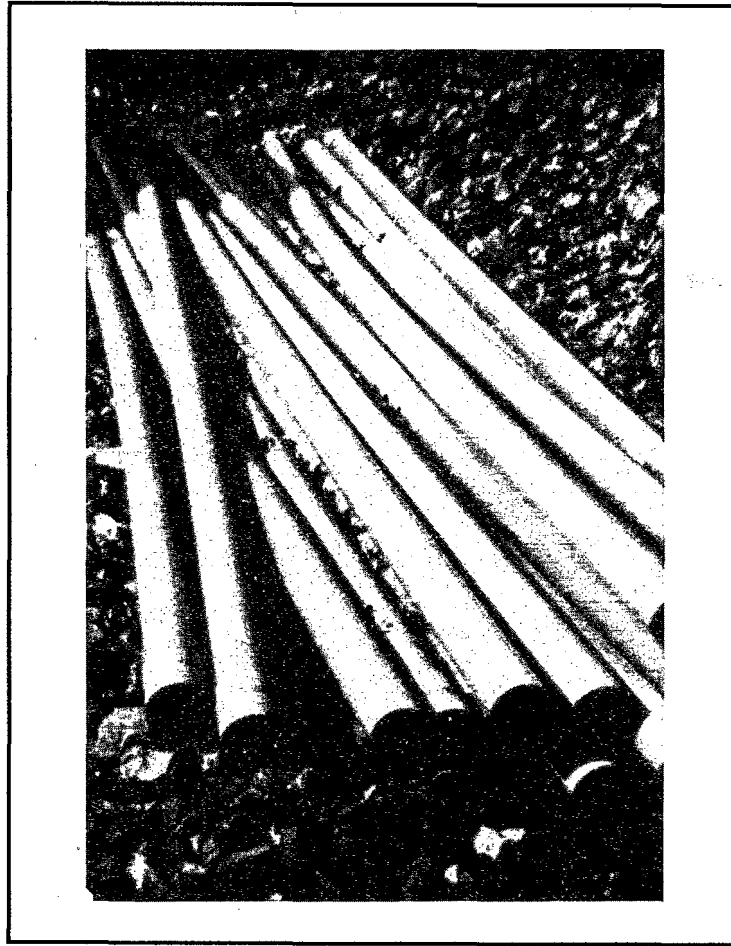

Figure 8.3 - Photograph of PVC Pipe to be Used in a Landfill Leachate Collection System.

1. The basic resin should be made from PVC as defined in ASTM D-1755. Details are contained therein.
2. Other materials in the formulation, such as fillers, carbon black/pigment and additives should be stipulated and certified as to the extent of their prior use in plastic pipe.
3. Clean rework material, generated from the manufacturer's own pipe or fitting production may be used by the same manufacturer providing that the rework material meets the above requirements. See section 3.2.2 for a description of possible use of reworked and/or recycled material.
4. Pipe tolerances and properties must meet the applicable standards for the particular grade required by the plans and specifications. For PVC pipe specified as Schedule 40, 80 and 120, the appropriate specification is ASTM D-1785. For PVC pipe in the standard dimension ratio (SDR) series, the applicable specification is ASTM D-2241.

5. Both of the above referenced ASTM Standards have sections on product marking and identification which should be followed as well as requiring the manufacturer to provide a certification statement stating that the applicable standard has been followed.
6. PVC pipe fittings should be in accordance with ASTM D-3034. This standard includes comments on solvent cement and elastomeric gasket joints as well as a section on product marking and certification.

8.1.2 High Density Polyethylene (HDPE) Smooth Wall Pipe

High density polyethylene (HDPE) smooth wall pipe has been used in waste containment systems for leachate collection and removal in a number of different locations and configurations. The pipe can be perforated or not depending on the site specific design. The pipes are often supplied in 6.1 m (20 ft) lengths which are generally joined together using butt-end fusion using a hot plate as per the gas pipe construction industry. Other joining variations such as bell and spigot, male-to-female and threading are also available. The HDPE material itself consists of 97-98% resin, approximately 2% carbon black and up to 1% additives. Figure 8.4 illustrates the use of HDPE smooth pipe.



Figure 8.4 - Photograph of HDPE Smooth Wall Pipe Risers Used as Primary and Secondary Removal Systems from Sump Area to Pump and Monitoring Station.

The following items should be considered regarding the contract specification or MQA document on HDPE solid wall pipe and fittings:

1. The basic material should be made of HDPE resin and should conform to the requirements of ASTM D-1248. Details are contained therein.
2. Quality control tests on the resin are typically density and melt flow index. The appropriate designations are ASTM D-1505 or D-792 and D-1238, respectively. Other in-house quality control tests should be encouraged and followed by the manufacturer.
3. Typical densities for HDPE pipe resins are 0.950 to 0.960 g/cc. This is a Type III HDPE resin according to ASTM D-1248 and is higher than the density of the resin used in HDPE geomembranes and geonets.
4. Carbon black can be added as a concentrate, as it customarily is, or as a powder. The type and amount of carbon black, as well as the type of carrier resin if concentrated pellets are used, should be stated and certified by the manufacturer.
5. The amount of additives used should be stated by the manufacturer. If certification is required it would typically not state the type of additive, since they are usually proprietary, but should state that the additive package has successfully been used in the past and to what extent.

8.1.3 High Density Polyethylene (HDPE) Corrugated Pipe

Corrugated high density polyethylene (HDPE), also called “profiled” pipe, has been used in waste containment systems for leachate collection and removal in a number of different locations and configurations. The pipe can be perforated or slotted depending on the site specific design. The inside can be smooth lined or not depending on the site specific design. The pipes are often supplied in 6.1 m (20 ft) lengths which are joined together by couplings made by the same manufacturer as the pipe itself. This is important since the couplings are generally not interchangeable among different pipe manufacturer’s products. The HDPE material itself consists of 97-98% resin, approximately 2% carbon black and up to 1% additives. Figure 8.5 illustrates HDPE corrugated pipe.

Regarding the contract specification or MQA document on HDPE corrugated pipe and fittings, the following items should be considered:

1. The basic material should be made of HDPE resin and should conform to the requirements of ASTM D-1248. Details are contained therein.
2. Quality control tests are typically density and melt flow index. Their designations are ASTM D-1505 or D-792 and D-1238, respectively. Other in-house quality control tests are to be encouraged and followed by the manufacturer.
3. Typical densities for HDPE pipe resins are 0.950 to 0.960 g/cc. This is a Type III HDPE resin according to ASTM D-1248 and is higher than the resin density used in HDPE geomembranes.
4. Carbon black can be added as a concentrate as it customarily is, or as a powder. The type and amount of carbon black, as well as the type of carrier resin if concentrated pellets are used, should be stated and certified by the manufacturer.

5. The amount of additives used should be stated by the manufacturer. If certification is required it would typically not state the type of additive, since they are usually proprietary, but should state that the additive package has successfully been used in the past.
6. The lack of ASTM documents for HDPE corrugated pipe should be noted. There is an AASHTO Specification available for corrugated polyethylene pipe in the 300 to 900 mm (12 to 36 in.) diameter range under the designation M294-90 and another for 75 to 250 mm (3 to 10 in.) diameter pipe under the designation of M252-90.

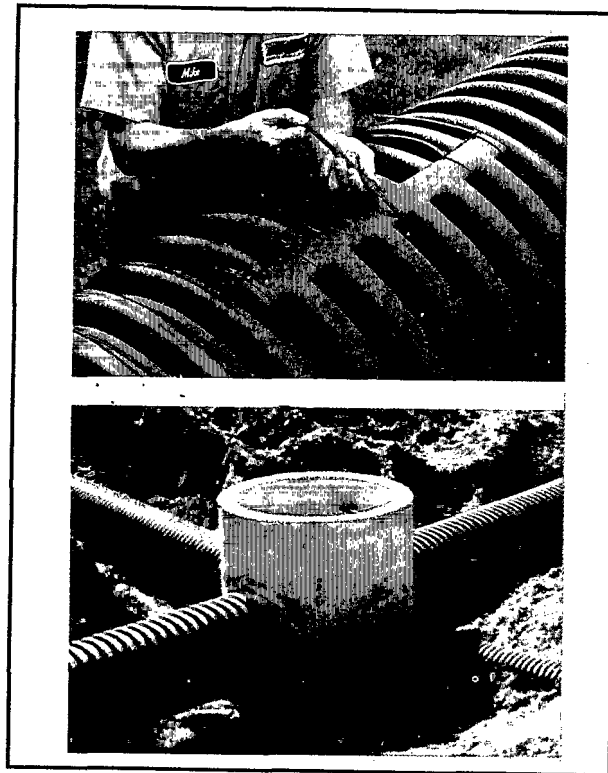

Figure 8.5 - Photograph of HDPE Corrugated Pipe Being Coupled and After Installed.

8.1.4 Handling of Plastic Pipe

As with all other geosynthetic materials a number of activities occur between the manufacturing of the pipe and its final positioning in the waste facility. These activities include packaging, storage at the manufacturers facility, shipment, storage at the field site, conformance testing and the actual placement.

8.1.4.1 Packaging

Both PVC pipe and HDPE pipe are manufactured in long lengths of approximately 6.1 m (20 ft) with varying wall thicknesses and configurations. They are placed on wooden pallets and bundled together with plastic straps for bulk handling and shipment. The packaging is such that either fork lifts or cranes using slings can be used for handling and movement. As the diameter and wall thickness increases, however, this may not be the case and above 610 mm (24 in.) diameter the pipes are generally handled individually.

8.1.4.2 Storage at Manufacturing Facility

Bundles of plastic pipe can be stored at the manufacturing facility for relatively long periods of time with respect to other geosynthetics. However, if stored outdoors for over 12 months duration, a temporary enclosure should be used to cover the pipe from ultraviolet exposure and high temperatures. Indoors, there is no defined storage time limitation. Pipe fittings are usually stored in a container or plastic net.

8.1.4.3 Shipment

Bundled pallets of plastic pipe are shipped from the manufacturer's or their representative's storage facility to the job site via common carrier. Ships, railroads and trucks have all been used depending upon the locations of the origin and final destination. The usual carrier from within the USA, is truck. When using flatbed trucks, the palletted pipe is usually loaded by means of a fork lift or a crane with slings wrapped around the entire unit. When the truck bed is closed, i.e., an enclosed trailer, the units are usually loaded by fork lift. Large size pipes above 610 mm (24 in.) in diameter are handled individually.

8.1.4.4 Storage at Field Site

Offloading of palletted plastic pipe at the site and temporary storage is a necessary follow-up task which must be done in an acceptable manner.

Items to be considered for the contract specification or CQA document are the following:

1. Handling of pallets of plastic pipe should be done in a competent manner such that damage does not occur to the pipe.
2. The location of field storage should not be in areas where water can accumulate. The pallets should be on level ground and oriented so as not to form a dam creating the ponding of water.
3. The pallets should not be stacked more than three high. Furthermore, they should be stacked in such a way that access for conformance testing is possible.
4. Outdoor storage of plastic pipe should not be longer than 12 months. For storage periods longer than 12 months a temporary covering should be placed over the pipes, or they should be moved to within an enclosed facility.

8.1.5 Conformance Testing and Acceptance

Upon delivery of the plastic pipe to the project site, and temporary storage thereof, the CQA engineer should see that conformance test samples are obtained. These samples are then sent to the

CQA laboratory for testing to ensure that the pipe supplied conforms to the project plans and specifications.

Items to consider for the contract specification or CQA document in this regard are the following:

1. The pipe should be identified according to its proper ASTM standard:
 - (a) for PVC Schedule 40, 80 and 120: see ASTM D-1785
 - (b) for PVC SDR Series: see ASTM D-2241
 - (c) for PVC pipe fittings: see ASTM D-3034
 - (d) for HDPE SDR Series: see ASTM D-1248 and ASTM F-714
 - (e) for HDPE corrugated pipe and fittings: see AASHTO M294-90 and M252-90.
2. The conformance test samples should make use of the same identification system as the appropriate ASTM standard, if one is available.
3. A lot should be defined as a group of consecutively numbered pipe sections from the same manufacturing line. Other definitions are also possible and should be clearly stated in the CQA documents.
4. Sampling should be done according to the contract specification and/or CQA documents. Unless otherwise stated, sampling should be based on one sample per lot, not to exceed one sample per 300 m (1000 ft) of pipe.
5. Conformance tests at the CQA Laboratory should include the following:
 - (a) for PVC pipe and fitting: physical dimensions according to ASTM D-2122, density according to ASTM D-792, plate bearing test according to ASTM D-2412, and impact resistance according to ASTM D-2444.
 - (b) for HDPE solid-wall and corrugated pipe: physical dimensions according to ASTM D-2122, density according to ASTM D-1505, plate bearing test according to ASTM D-2412 and impact resistance according to ASTM D-2444.
 - (c) for HDPE corrugated pipe in the 300 to 900 mm (12 to 36 in.) range see AASHTO M294-90 and in the 75 to 250 mm (3 to 10 in.) range see AASHTO M252-90.
6. Conformance test results should be sent to the CQA engineer prior to deployment of any pipe from the lot under review.
7. The CQA engineer should review the results and should report any non-conformance to the Project Manager.
8. The resolution of failing conformance tests should be clearly stipulated in the specifications or CQA documents.

8.1.6 Placement

Plastic pipe is usually placed in a prepared trench or within other prepared subgrade materials. If the pipe is to be placed on or near to a geomembrane, as in the leachate collection system shown in Fig. 8.1, the drainage sand or stone should be placed first. There may be a requirement to lightly compact sand to 90% relative density according to ASTM D-4254. Small excavations of slightly greater than the diameter of the pipe are then made, and the pipe is placed in these shallow excavations. Thus a trench, albeit a shallow one, is constructed in all cases of pipe placement in leachate collection sand or stone.

Where plastic pipe is placed at other locations adjacent to the containment facility and the soil is cohesive, compaction is critical if high stresses are to be encountered. Compaction control is necessary, e.g., 95% of standard Proctor compaction ASTM D-698 is recommended so as to prevent subsidence of the pipe while in service.

The importance of the density of the material beneath, adjacent and immediately above a plastic pipe insofar as its load-carrying capability is concerned cannot be overstated. Figure 8.6 shows the usual configuration and soil backfill terminology related to the various materials and their locations.

Regarding a specification or CQA document for plastic pipe placement, ASTM D-2321 should be referenced. For waste containment facilities the following should be considered:

1. The soil beneath, around and above the pipe shall be Class IA, IB or II according to ASTM D-2321.
2. The backfill soil should extend a minimum of one pipe diameter above the pipe, or 300 mm (12 in.) whichever is smaller.
3. Other conditions should be taken directly according to ASTM D-2321.
4. Pipe fittings should be in accordance with the specific pipe manufacturer's recommendations.

8.2 Sumps, Manholes and Risers

Leachate which migrates along the bottom of landfills and waste piles flows gravitationally to a low point in the facility or cell where it is collected in a sump. Two general variations exist; one is a prefabricated sump, made either in-situ or off-site, with a manhole extension rising vertically through the waste and final cover, the other is a low area formed in the liner itself with a solid wall pipe riser coming up the side slope where it eventually penetrates the final cover. Both variations are shown schematically in the sketches of Fig. 8.7. In addition, the sump and sidewall riser of a secondary leachate collection system typically used in double lined facilities is shown in the right sketch of Fig. 8.7(b), i.e., a leak detection system. Each type of system will be briefly described.

Many existing landfills have been constructed with primary leachate collection and removal sumps and manholes constructed to the site specific plans and specifications as shown in the left hand sketch of Fig. 8.7(a). The vertical riser is either a concrete or plastic standpipe placed in 3 m (10 ft) sections. It is extended as the waste is placed in the facility and eventually it must penetrate the final cover. Leachate is removed from this manhole, on an as demanded basis, by a submersible pump which is permanently located in the sump.

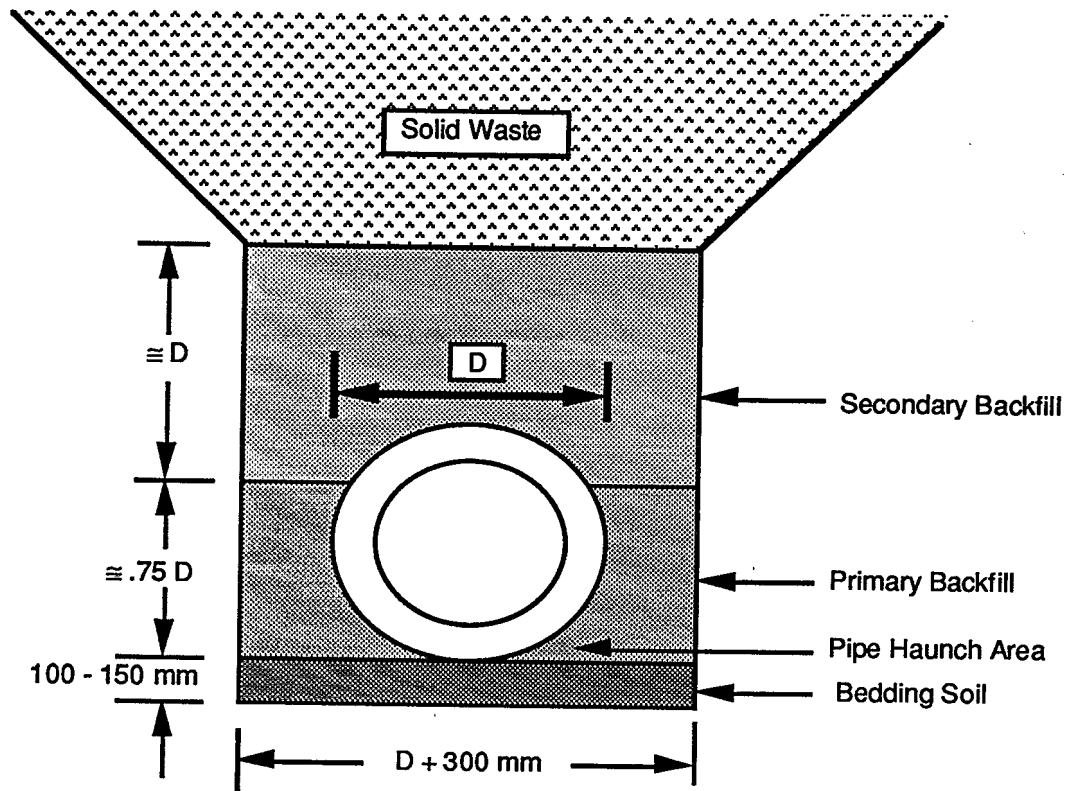
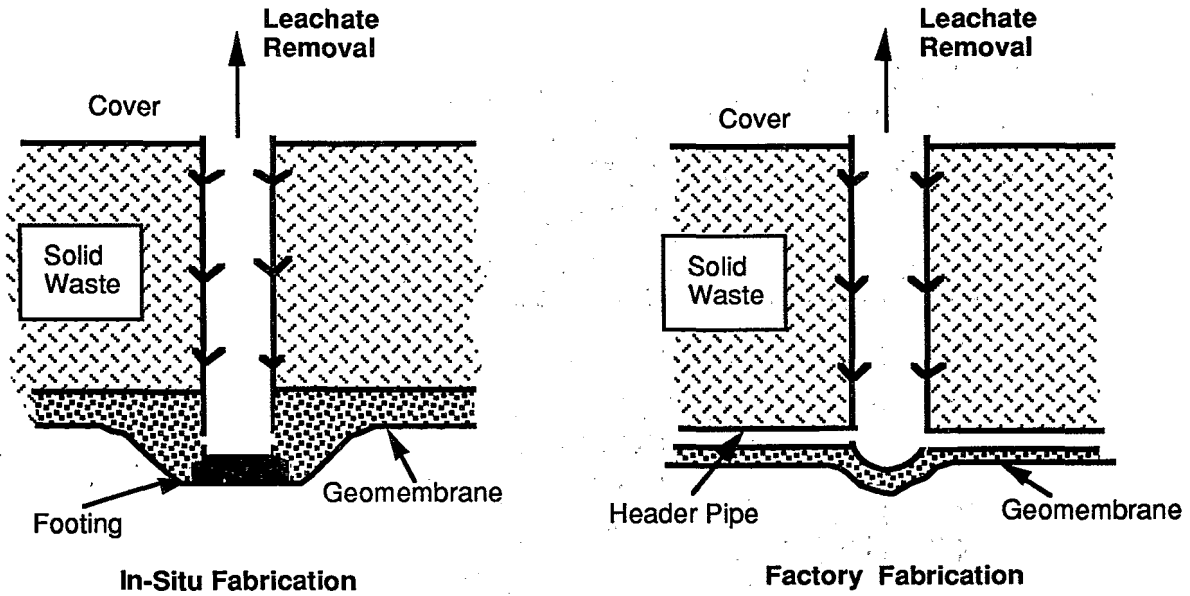

Figure 8.6 - A Possible Buried Pipe Trench Cross Section Scheme Showing Soil Backfill Terminology and Approximate Dimensions (for illustration purposes only).

A more recent variation of the above removal system is an off-site factory fabricated sump and manhole system wherein the leachate collection pipe network frames directly into the sump, see the right hand sketch of Fig. 8.7(a). Various standardized sump capacities are available. This type of system requires the least amount of field fabrication. The riser is extended in sections as the waste is placed in the facility and eventually it must penetrate the final cover. Leachate is removed from the manhole by a submersible pump which is permanently located in the sump.

Quite a different variation for primary leachate removal is a well defined low area in the primary geomembrane into which the leachate collection pipe network flows. This low area creates a sump which is then filled with crushed stone and from which a pipe riser extends up the side slope. The pipe riser is usually a solid wall pipe with no perforations. When the facility is eventually filled with solid waste, the riser must penetrate the cover as shown in the left hand sketch of Fig. 8.7(b). The leachate is withdrawn using a submersible pump which is lowered down the pipe riser on a sled and left in place except for maintenance and/or replacement, recall Fig. 8.4.



(a) Types of Primary Leachate Collection Sumps and Manholes with Vertical Standpipe Going through the Waste and Cover

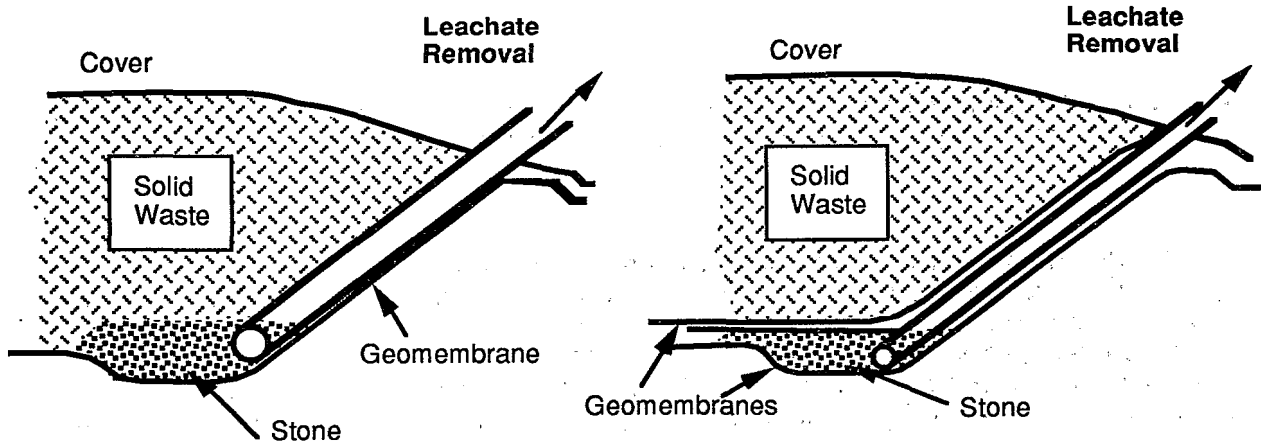

(b) Types of Primary (Left) and Secondary (Right) Leachate Collection Sumps and Pipe Risers Going Up the Side Slopes

Figure 8.7 - Various Possible Schemes for Leachate Removal

In a similar manner as above, but now for secondary leachate removal, a sump can be formed in the secondary liner system which is filled with gravel as shown in the right hand sketch of Fig. 8.7(b). A solid wall pipe riser, perforated in its lower section, extends up the sidewall between the primary and secondary liner where it must penetrate both the primary liner, and eventually the cover system liner, see the right hand sketch of Fig. 8.7(b). This pipe riser is often a solid wall pipe in the 100-200 (4 to 8 in.) diameter range with no perforations. The leachate is withdrawn and/or monitored using a small diameter sampling pump which is lowered down the riser and left in place except for maintenance and/or replacement, recall Fig. 8.4.

Some specification and CQA document considerations for the various sump, manhole and riser schemes just described are as follows. Note, however, that there are other possible design schemes that are available in addition to those mentioned above.

1. In-situ fabrication of sumps requires a considerable amount of hand labor in the field. Seams for HDPE and VLDPE geomembranes are extrusion fillet welded, while PVC and CSPE-R geomembranes are usually bodied chemical seams (EPA, 1991). Careful visual inspection is necessary.
2. The soil support beneath the sumps and around the manhole risers of plastic pipes is critically important. The specification should reference ASTM D-2321 with only backfill types IA, IB and II being considered.
3. Riser pipes for primary and secondary leachate removal are generally not perforated, except for the lowest section of pipe which accepts the leachate.
4. Riser pipe joints for primary and secondary leachate removal require special visual attention since neither destructive nor nondestructive tests can usually be accommodated.
5. The sump, manholes and risers must be documented by the CQA engineer before acceptance and placement of solid waste.

8.3 Liner System Penetrations

Although the intention of most designers of waste containment facilities is to avoid liner penetrations, leachate removal is inevitably required at some location(s) of the barrier system. Recall Fig. 8.7 where the cover is necessarily penetrated for primary leachate removal. For leak detection both the primary liner and the cover liner must be penetrated. It should also be recognized that the penetrations will include geomembranes, compacted clay liners and/or geosynthetic clay liners. Figure 8.8 illustrates some details of pipe penetrations through all three types of barrier materials.

The following recommendations are made for a specification or CQA document:

1. Geomembrane pipe boots are usually factory fabricated to a size which tightly fits the outside diameter of the penetrating pipe. Unique situations, however, will require field fabrication, e.g., when pipe penetration angles are unknown until final installation.
2. The skirt of the pipe boot which flares away from the pipe penetration should have at least 300 mm (12 in.) of geomembrane on all sides of the pipe.
3. The skirt of the pipe boot should be seamed to the base geomembrane by extrusion fillet or bodied chemical seaming depending on the type of geomembrane (EPA, 1991).

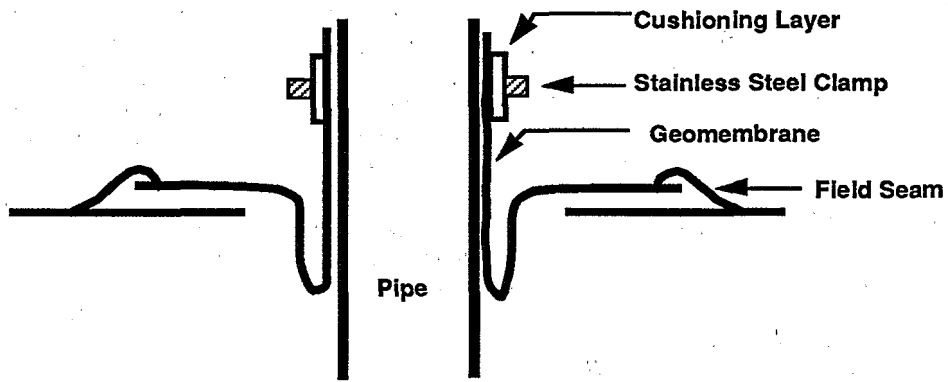

(a) Geomembrane Penetration

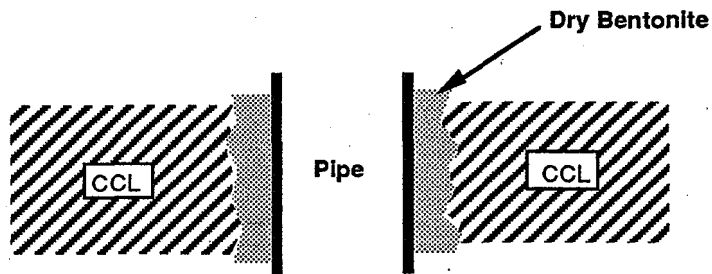

(b) Compacted Clay Liner (CCL) Penetration

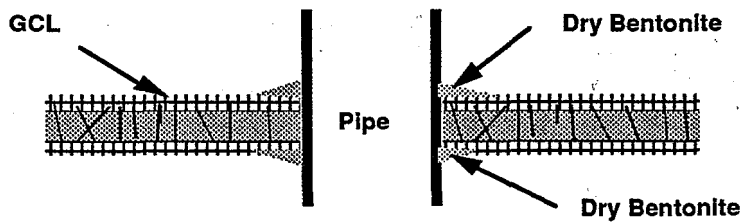

(c) Geosynthetic Clay Liner (GCL) Penetration

Figure 8.8 - Pipe Penetrations through Various Types of Barrier Materials

4. The nondestructive testing of the skirt of the pipe boot should be by vacuum box or air lance depending on the type of geomembrane. Refer to Section 3.6.2.
5. The pipe boot should be of the same type of geomembrane as that of the liner through which the penetration is being made.
6. Pipe penetrations should be positioned with sufficient clearance to allow for proper welding and inspection.
7. Stainless steel pipe clamps used to attach pipe boots to the penetrating pipes should be of an adequate size to allow for a cushion of compressible material to be placed between the inside surface of the clamp and that of the geomembrane portion of the pipe boot.
8. Location of pipe clamps should be as directed on the plans and specifications.
9. Pipe penetrations through compacted clay liners and geosynthetic clay liners should use an excess of hand placed dry bentonite clay as directed in the plans and specifications.

8.4 Anchor Trenches

Generally, the geosynthetics used to line or cover a waste facility end in an anchor trench around the individual cell or around the entire site.

8.4.1 Geomembranes

The termination of a geomembrane at the perimeter of landfill cells or at the perimeter of the entire facility generally ends in an anchor trench. As shown in Fig. 8.9, the variations are numerous. Such details should be specifically addressed in the construction plans and specifications.

Some general items that should be addressed in the specification or CQA documents regarding geomembrane termination in anchor trenches are as follows:

1. The seams of adjacent sheets of geomembranes should be continuous into the anchor trench to the full extent indicated in the plans and specifications.
2. Seaming of geomembranes within the anchor trench can be accomplished by temporarily supporting the adjacent sheets to be seamed on a wooden support platform in order that horizontal seaming can be accomplished continuously to the end of the geomembrane sheets. The temporary support is removed after the seam is complete and the geomembrane is then allowed to drop into the anchor trench.
3. Destructive seam samples can be taken while the seamed geomembrane is temporarily supported in the horizontal position.
4. Nondestructive tests can also be performed while the seamed geomembrane is temporarily supported in the horizontal position.
5. The anchor trench is generally backfilled after the geomembrane has been documented by the CQA engineer, but may be at a later date depending upon the site specific plans and specifications.

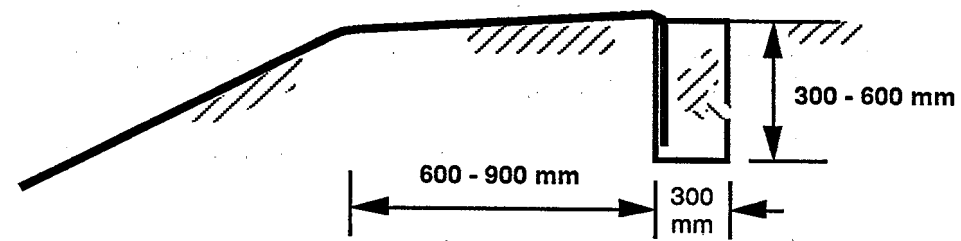

Typical Anchor Trench

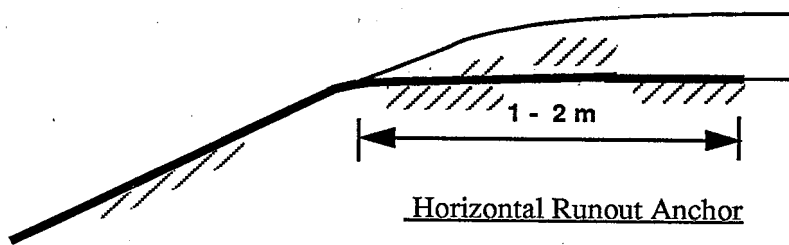

Horizontal Runout Anchor

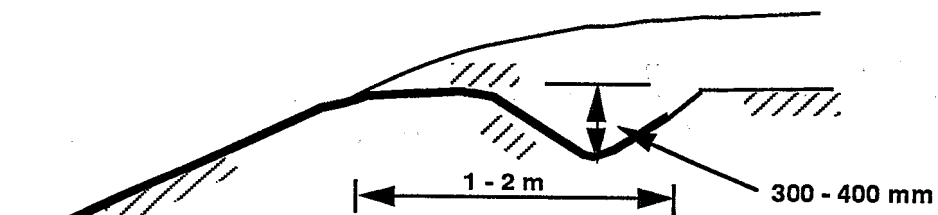

Shallow "V" Anchor Trench

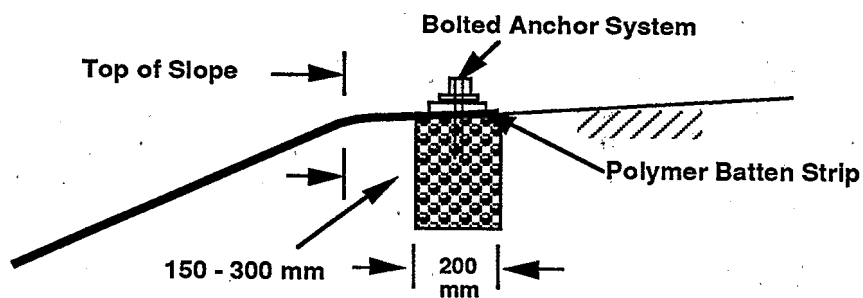

Concrete Anchor Block

Figure 8.9 - Various Types of Geomembrane Anchors Trenches (Dimensions are Typical and for Example Only).

6. The anchor trench itself should be made with slightly rounded corners so as to avoid sharp bends in the geomembrane. Loose soil should not be allowed to underlie the geomembrane in the anchor trench.
7. The anchor trench should be adequately drained to prevent ponding of water or softening of the adjacent soils while the trench is open.
8. Backfilling in the anchor trench should be accomplished with approved backfill soils placed at their required moisture content and compacted to the required density.
9. The plans and specifications should provide detailed construction requirements for anchor trenches regardless if soils or other backfill materials are used.

8.4.2 Other Geosynthetics

Since all geosynthetics, not only geomembranes, need adequate termination, some additional comments are offered for plans, specifications or CQA documents.

1. Geotextiles, either beneath or above geomembranes, usually follow their associated geomembrane into the same type of anchor trenches as shown in Fig. 8.9.
2. Geonets may or may not terminate in the anchor trench. Water transmission from beyond the waste containment may be a concern when requiring termination of the geonet within the geomembrane's anchor trench or in a separate trench by itself. Thus termination of a geonet may be short of the associated geomembrane's anchor trench. This is obviously a design issue and must be clearly detailed in the contract plans and specifications.
3. When used by themselves, geosynthetic clay liners (GCLs) will generally terminate in an anchor trench in soil of the type shown in Fig. 8.9. When GCLs are with an associated geomembrane, as in a composite liner, each component will sometimes end in a separate anchor trench. These are design decisions.
4. Double liner systems will generally have separate anchor trenches for primary and secondary liner systems. This is a design decision.
5. In all of the above cases, the plans and specifications should provide detailed dimensions and construction requirements for anchor trenches of all geosynthetic components.
6. The plans and specifications should also show details of how natural soil components, e.g., compacted clay liners and sand or gravel drainage layers, terminate with respect to one another and with respect to the geosynthetic components.

8.5 Access Ramps

Heavily loaded vehicles must enter the landfill facility during construction activities and during placement of the solid waste. Typical access ramps will be up to 5.5 m (18 ft.) in width and have grades up to 12%. The general geometry of an access ramp is shown in Fig. 8.10(a).

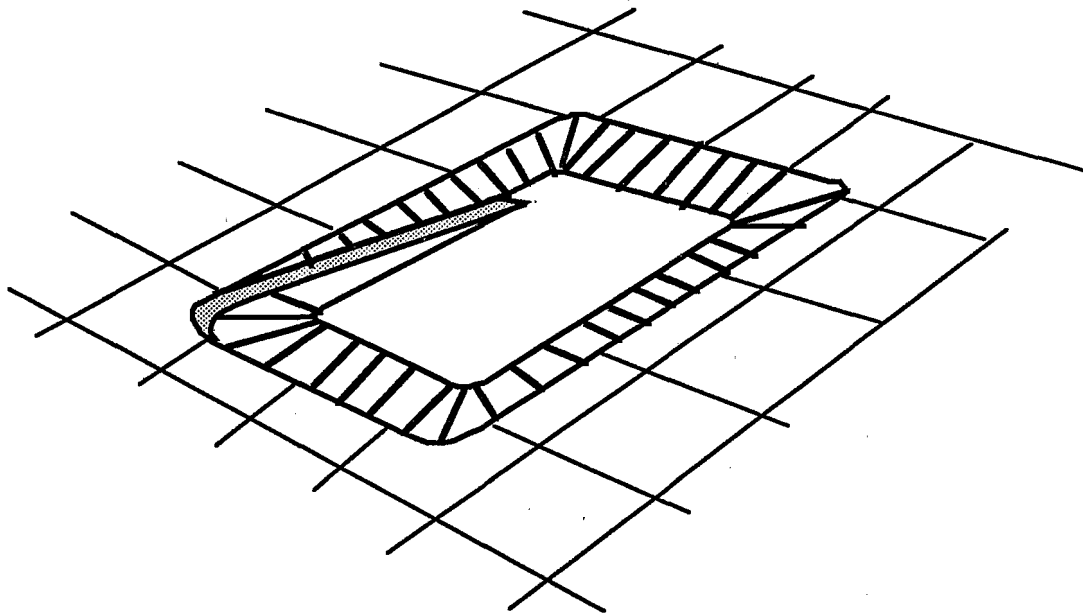

(a) Geometry of a Typical Ramp

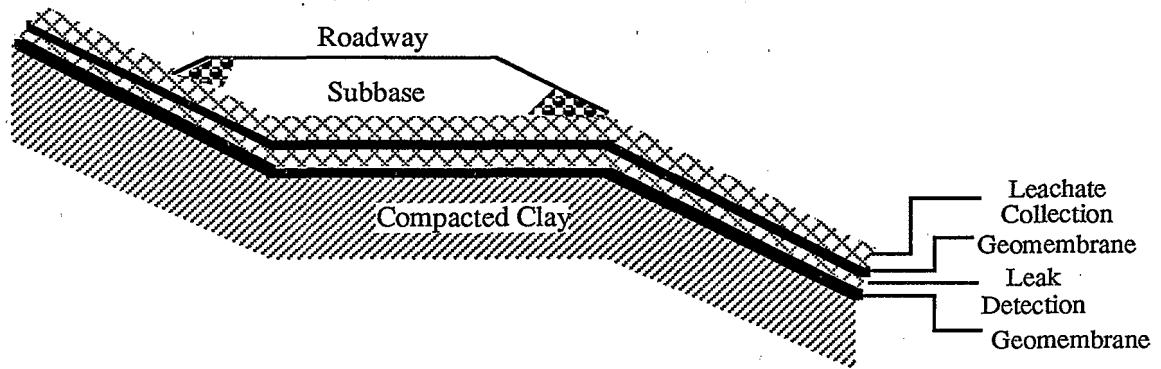

(b) Cross Section of Ramp Roadway

Figure 8.10 - Typical Access Ramp Geometry and Cross Section

The traffic loads on such a ramp can be extremely large and generally involve some degree of dynamic force due to the constant braking action which drivers use when descending the steep grades. Note that the entire liner cross section must extend uninterrupted from the upper slope to the lower slope and in doing so must necessarily pass beneath the roadway base course. When working with a double lined facility this can involve numerous geosynthetic and natural soil layers. Further complicating the design issues is that drainage from the upper side slopes must communicate beneath the roadway base course layer or travel parallel to it and be contained accordingly. A reinforcing element (geotextile or geogrid) can be incorporated in the roadway base course material. This can serve several purposes; i.e., to protect long-term integrity of underlying systems, to minimize potential sliding failures, and to minimize potential rutting and bearing capacity failures. These are critical design issues and must be well defined in the plans and specifications.

Regarding recommendations for the contract specifications or CQA document, the following items apply:

1. Many facilities will limit the number of vehicles on the access ramp at a given time. Such stipulations should be strictly enforced.
2. Vehicle speeds on access ramps should be strictly enforced.
3. Regular inspection should be required to observe if tension cracks open in the roadway base coarse soils. This may indicate some degree of slippage of the soil and possible damage to the liner system.
4. Ponding of upper slope runoff water against the roadway profile should be observed for possible erosion effects and loss of base course material. If a drainage ditch or pipe system is indicated on the plans, it should be constructed as soon as possible after completion of the roadway subbase soils.
5. The roadway base course profile should be fully maintained for the active lifetime of the facility.

8.6 Geosynthetic Reinforcement Materials

For landfill and waste pile covers with slopes greater than 3 horizontal to 1 vertical (3H:1V), stability issues regarding downgradient sliding begin to be important. Additionally, the stability of primary leachate collection systems for landfill and waste pile liners with slopes greater than 3H : 1V is suspect at least until the solid waste material within the unit raises to a stabilizing level. Such issues, of course, must be considered during the design phase and the contract plans and specifications must be very clear on the method of reinforcement, if any. If reinforcement is necessary it can be accomplished by using geotextiles or geogrids within the layer contributing to the instability to offset some, or even all, of the gravitational stresses. Refer to Fig. 8.11(a) and (b) for the general orientation of such reinforcement, which is sometimes called "vener reinforcement".

The concept of using geogrid or geotextile reinforcement to support a liner or liner system when a new landfill is built above, or adjacent to, an existing landfill has recently been developed. The technique has been referred to as "piggybacking" when vertical expansions are involved, see Fig. 8.11(c). The main focus of the reinforcement is to provide stability against differential settlement which can occur in the existing landfill.

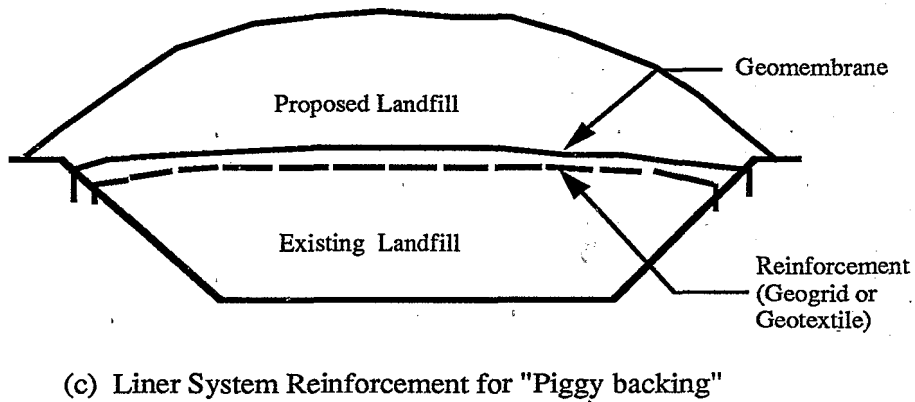
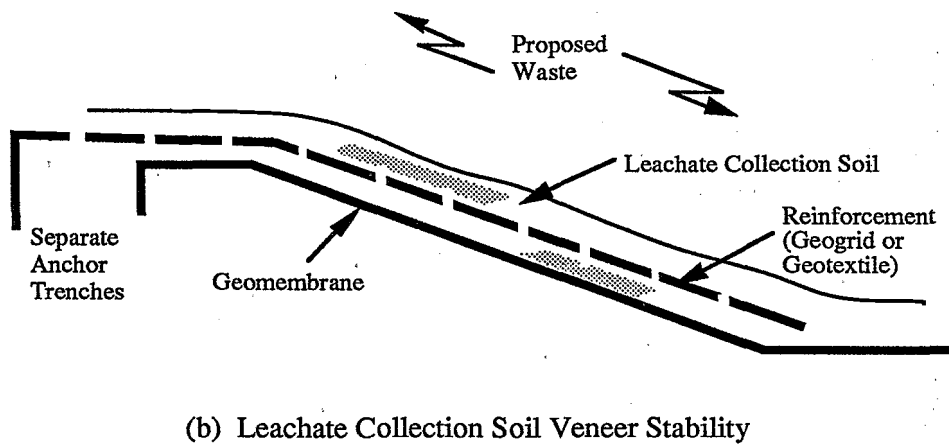
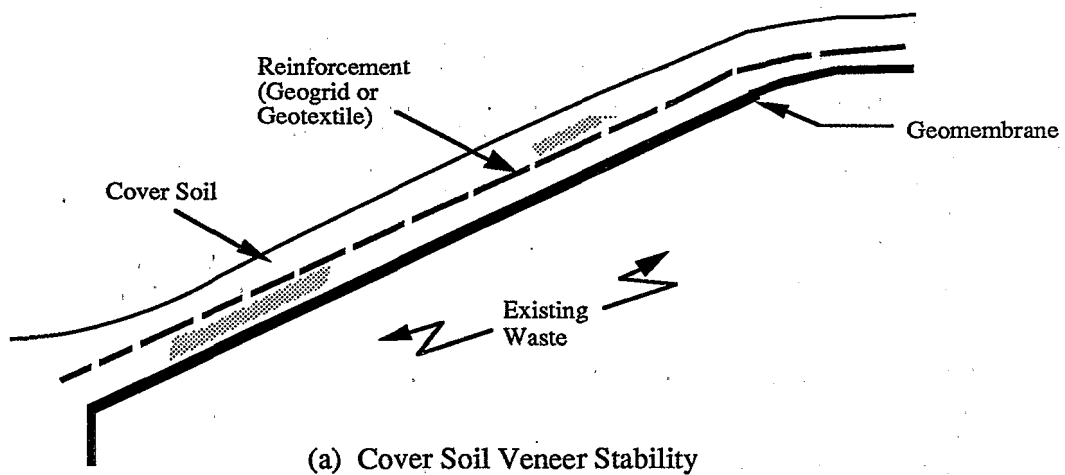

Figure 8.11 - Geogrid or Geotextile Reinforcement of (a) Cover Soil above Waste, (b) Leachate Collection Layer beneath Waste, and (c) Liner System Placed above Existing Waste ("Piggybacking")

Since geotextiles were described previously from a manufacturing standpoint and for separation and filtration applications, they will be discussed here only from their reinforcement perspective. Geogrids will be described from both their manufacturing and reinforcement perspectives.

8.6.1 Geotextiles for Reinforcement

The manufacturing of geotextiles was described in section 6.2 along with recommendations for MQC and MQA documents. Regarding CQC and CQA, the focus was on separation and filtration applications. Some specific recommendations regarding reinforcement geotextiles for a specification or CQA document are as follows:

1. A manufacturer's certification should be provided that the geotextile meets the property criteria specified for the geotextile that was approved for use on the project via the plans and specifications.
2. CQA personnel should check that the geotextile delivered to the job site is the proper and intended material. This is done by verifying the identification label and its coding and by visual identification of the product, its construction and other visual details.
3. Conformance samples of the geotextile supplied to the job site should be obtained as per ASTM D-4759. Typically, the outer wrap of the rolls are used for such sampling.
4. Conformance tests should be the following. Wide width tensile strength per ASTM D-4595, trapezoidal tear strength per ASTM D-4533 and puncture strength per ASTM D-4833. Additional conformance tests which may be considered are polymer identification via thermogravimetric analysis (TGA) and grab tensile strength, via ASTM D-4632.
5. Field placement of geotextiles should be at the locations indicated on the contract plans and in the specifications. Details of overlapping or seaming should be included.
6. Geotextile deployment is usually from the top of slope downward, so that the geotextile is taut before soil backfilling proceeds.
7. If the upper end of the geotextile should be anchored in an anchor trench, the details shown in the contract plans should be fulfilled.
8. Soil backfilling should proceed from the bottom of the slope upward, with a minimum backfill thickness of 220 mm (9 in.) of cover using light ground contact construction equipment of 40 kPa (6 lb/in²) contact pressure or less.
9. Seams in geotextiles on side slopes are generally not allowed. If permitted, they should be located as close to the bottom of the slope as possible. Seams should be as approved by the CQA engineer. Test strips of seams should be requested for conformance tests in the CQA laboratory following ASTM D-4884.

8.6.2 Geogrids

Geogrids are reinforcement geosynthetics formed by intersecting and joining sets of longitudinal and transverse ribs with resulting open spaces called "apertures". Two different classes of geogrids are currently available, see Fig. 8.12(a). They are the following: (a) stiff, unitized, geogrids made from polyethylene or polypropylene sheet material which is cold worked into a post-yield state, and (b) flexible, textile-like geogrids made from high tenacity polyester yarns which are joined at their intersections and coated with a polymer or bitumen. Figure 8.12 (b) shows geogrids being used as veneer reinforcement.

Some recommended contract specification or CQA document items that should be addressed when using geogrids as reinforcement materials are as follows:

1. A manufacturer's certification should be provided that the geogrid meets the property criteria specified for the geogrid that was approved for use on the project per the plans and specifications.
2. CQA personnel should check that the geogrid delivered to the job site is the proper and intended material. This is done by verifying the identification label and its coding and by visual identification of the product, its rib joining, thickness and aperture size. If the geogrid has a primary strength direction it must be so indicated.
3. Conformance samples of the geogrid supplied to the job site should be obtained as per ASTM D-4759. Typically, the outer wrap of the rolls are used for such sampling.
4. Conformance tests should be the following. Aperture size by micrometer or caliper measurement, rib thickness and junction thickness by ASTM D-1777, and wide width tensile strength by ASTM D-4595 suitably modified for geogrids. Additional conformance tests which may be considered are polymer identification via thermal analysis methods and single rib tensile strength, via GRI GG1.
5. Field placement of geogrids should be at the locations indicated on the contract plans and in the specifications. Details of overlapping or seaming should be included.
6. Geogrid deployment is usually from the top of slope downward, so that the geogrid is taut before soil backfilling proceeds.
7. If the upper end of the geogrids are to be anchored in an anchor trench, the details shown in the contract plans should be fulfilled.
8. Soil backfilling should proceed from the bottom of the slope upward, with a minimum backfill thickness of 22 cm (9.0 in.) of cover using light ground contact construction equipment of 40 kPa (6 lb/in²) contact pressure or less.
9. Connections of geogrid rolls on side slopes should generally be avoided. If permitted, they should be located as close to the bottom of the slope as possible. Connections should be as approved by the CQA engineer. Test strips of connections should be requested for conformance tests in the CQA laboratory following ASTM D-4884 (mod.) test method.

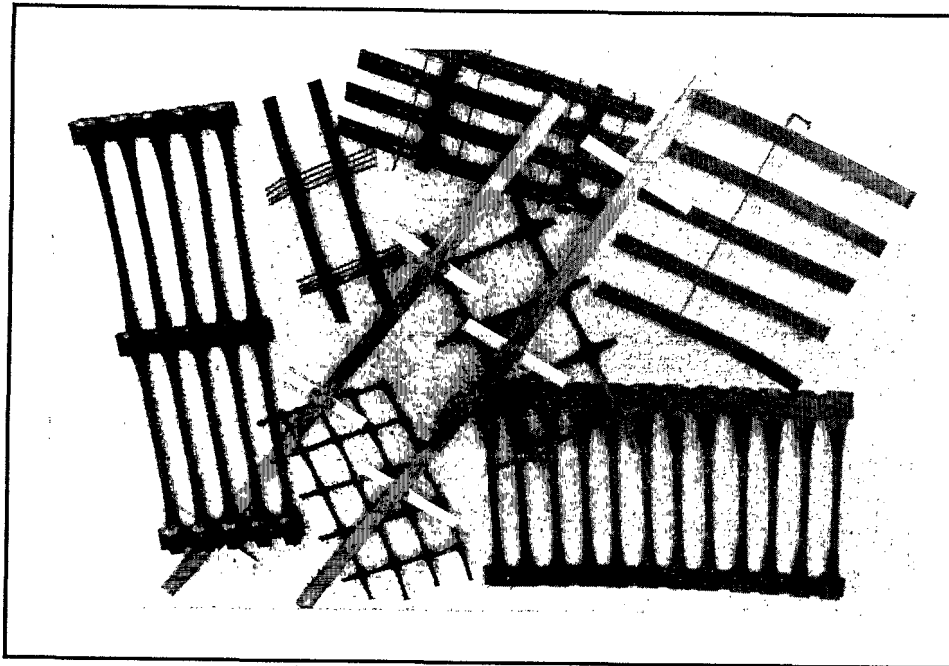

(a) Various Types of Geogrids

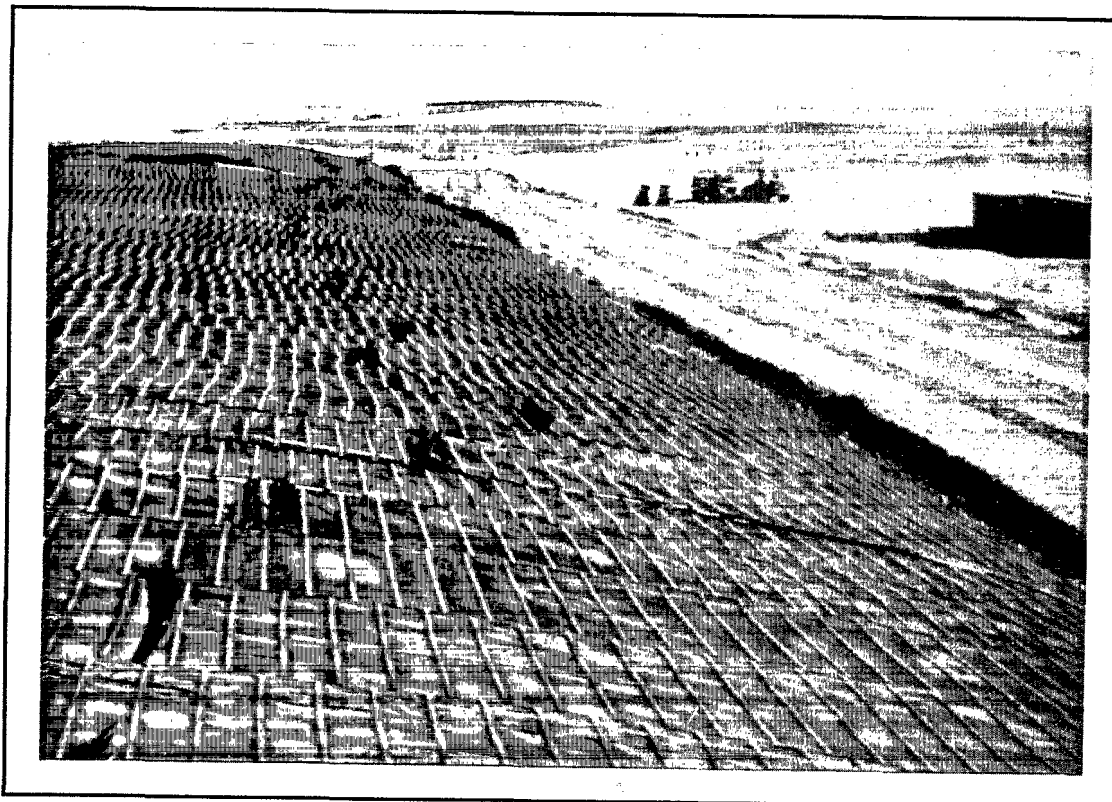

(b) Geogrids Used as Veneer Reinforcement

Figure 8.12 - Photographs of Geogrids Used as Soil (or Waste) Reinforcement Materials

8.7 Geosynthetic Erosion Control Materials

Often on sloping solid waste landfill covers soil loss in the form of rill, gully or sheet erosion occurs in the topsoil and sometimes extends down into the cover soil. This requires continuous maintenance until the phenomenon is halted and the long-term vegetative growth is established. Alternatively, the design may call for a temporary, or permanent, erosion control system to be deployed within or on top of the topsoil layer. Additional concerns regarding erosion control are on perimeter trenches, drainage ditches, and other surface water control structures associated with waste containment facilities. Listed below are a number of alternative erosion control systems ranging from the traditional hand distributed mulching to fully paved cover systems. They fall into two major groups; temporary degradable and permanent nondegradable.

Temporary Erosion Control and Revegetation Mats (TERMs)

- Mulches (hand or machine applied straw or hay)
- Mulches (hydraulically applied wood fibers or recycled paper)
- Jute Meshes
- Fiber Filled Containment Meshes
- Woven Geotextile Erosion Control Meshes
- Fiber Roving systems (continuous fiber systems)

Permanent Erosion Control and Revegetation Mats (PERMs)

- Geosynthetic Systems
 - turf reinforcement and revegetation mats (TRMs)
 - erosion control and revegetation mats (ECRMs)
 - geomatting systems
 - geocellular containment systems
- Hard Armor Systems
 - cobbles, with or without geotextiles
 - rip-rap, with or without geotextiles
 - articulated concrete blocks, with or without geotextiles
 - grout injected between geotextiles
 - partially or fully paved systems

Temporary degradable systems are used to enhance the establishment of vegetation and then degrade leaving the vegetation to provide the erosion protection required. Challenging sites

that require protection above and beyond what vegetation can provide need to use a permanent nondegradation system, i.e., high flow channels, over steepened slopes etc. Of these various alternatives, jute meshes, containment meshes and geosynthetic systems are used regularly on landfill and waste pile cover systems, see Fig. 8.13.

Some items which are recommended for contract specifications or CQA document for these particular systems are as follows:

1. The CQA personnel should check the erosion control material upon delivery to see that the proper materials have been received.
2. Water and ultraviolet sensitive materials should be stored in dry conditions and protected from sunlight.
3. If the erosion control material has defects, tears, punctures, flaws, deterioration or damage incurred during manufacture, transportation or storage it should be rejected or suitably repaired to the satisfaction of the CQA personnel.
4. If the material is to be repaired, torn or punctured sections should be removed by cutting a cross section of the material out and replacing it with a section of undamaged material. The ends of the new section should overlap the damaged section by 30 cm (12 in.) and should be secured with ground anchors.
5. All ground surfaces should be prepared so that the material lies in complete contact with the underlying soil.
6. Ground anchors, called "pins", should be at least 30 cm (12 in.) long with an attached oversized washer 50 mm (2.0 in.) in diameter, or "staples" number 8 gauge "U" shaped wire at least 20 cm (8.0 in.) long. For less severe temporary applications e.g., TERMS's, one may consider 15 cm (6 in.) number 11 gauge "U" shaped wire staples.
7. Adjacent rolls of erosion control material shall be overlapped a minimum of 75 mm (3.0 in.). Staples should secure the overlaps at 75 cm (2.5 ft) intervals. The roll ends should overlap a minimum of 45 cm (18 in.) and be shingled downgradient. The end overlaps should be stapled at 45 cm (1.5 ft) intervals, or closer, or as recommended by the manufacturer.
8. If required on the plans and specifications, the erosion control material should be filled with topsoil, lightly raked or brushed into the mat to either fill it completely or to a maximum depth of 25 mm (1.0 in.).
9. For geosynthetic materials used in drainage ditches, their overlaps should always be shingled downgradient with overlaps as recommended by the manufacturer or plans and specifications whichever is the greatest.
10. If required by the plans and specifications, the manufacturer of the erosion control or drainage ditch material should provide a qualified and experienced representative on site to assist the installation contractor at the start of construction. After an acceptable routine is established, the representative should be available on an as-needed basis, at the CQA engineer's request.

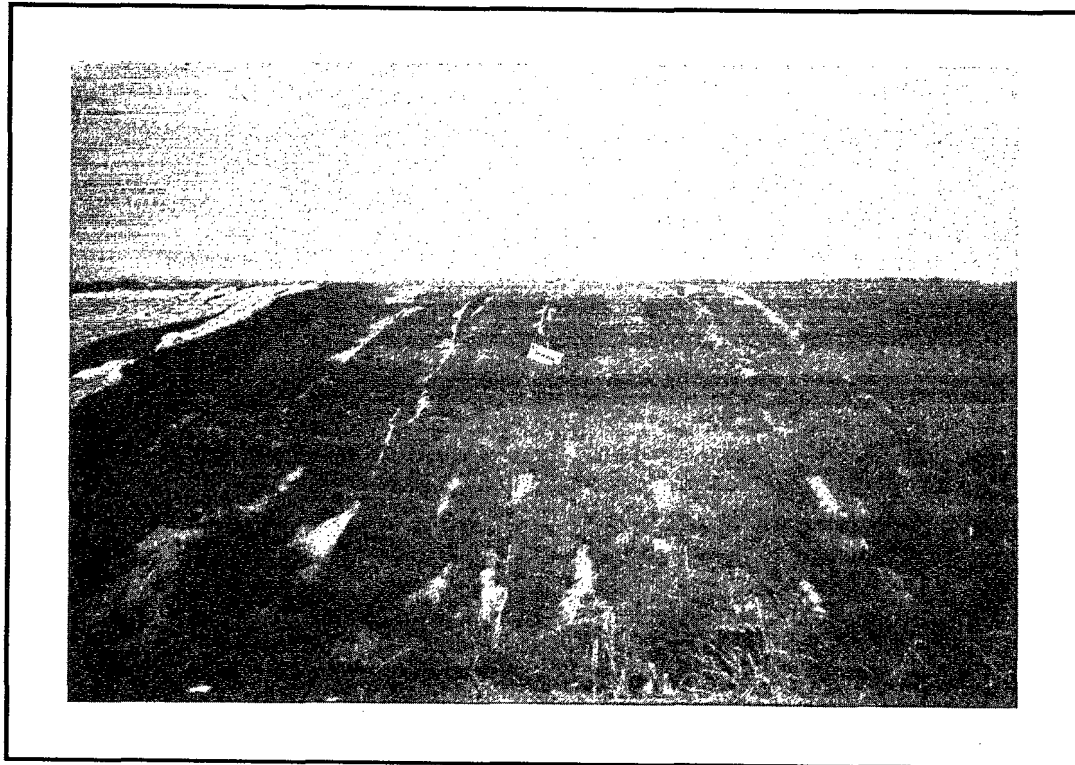
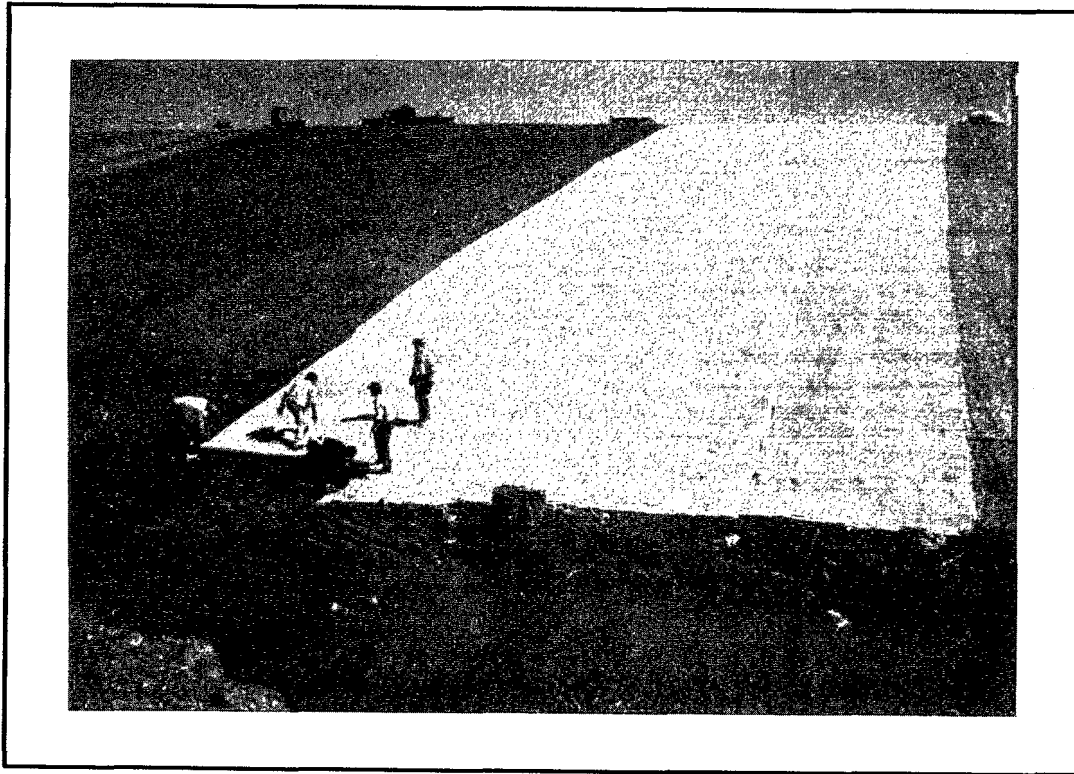

Figure 8.13 - Examples of Geosynthetic Erosion Control Systems



Figure 8.13 - Continued

8.8 Floating Geomembrane Covers for Surface Impoundments

In concluding this Chapter, it was felt that a short section on geomembrane floating covers for liquid wastes contained in surface impoundments is appropriate. These floating covers are geomembranes of the types discussed in Chapter 3. Hence all details such as polymer type, production, conformance testing, etc., are applicable here as well. The uniqueness of the application is that the geomembrane is always exposed to the atmosphere, thus subject to sunlight, heat, damage, etc., and furthermore it must be rigidly anchored to a concrete anchor trench or other similar structure, surrounding the perimeter of the facility, see Fig. 8.14.

Some items in addition to those mentioned in Chapter 3 on geomembranes that are recommended for a contract specification or a CQA document are as follows:

1. Acceptance of the geomembrane should have some verification as to its weatherability characteristics. The tests most frequently referenced are ASTM D-4355 and ASTM G-26. There is also a growing body of data being developed under the ASTM G-53 test method.
2. Other conformance tests, e.g., physical and mechanical property tests, are product specific and have been described in Chapter 3.

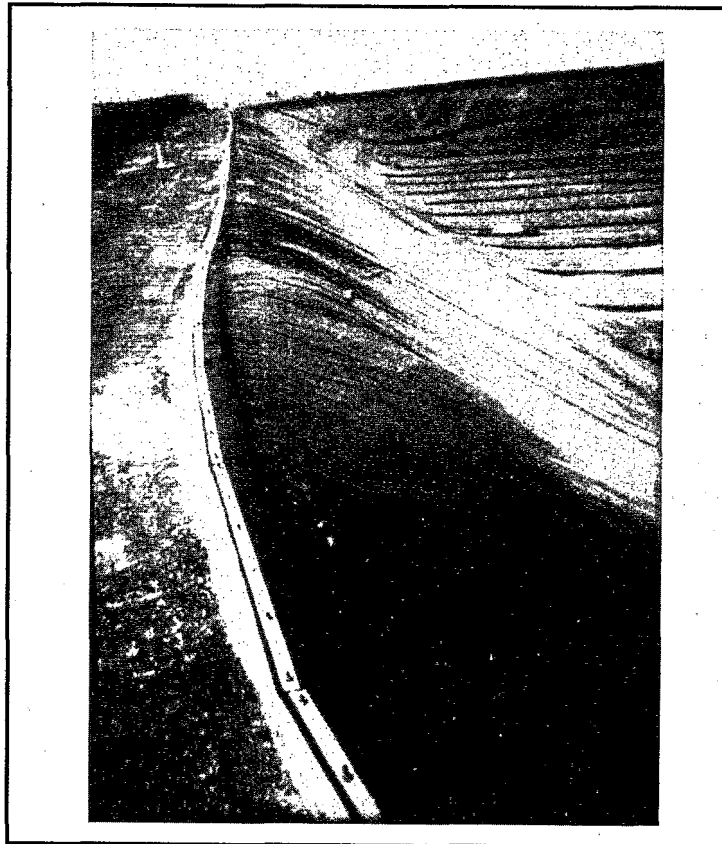

Figure 8.14 - Surface Impoundments with Geomembrane Floating Covers along with Typical Details of the Support System and/or Anchor Trench and Batten Strips

3. The anchorage detail for floating covers is critically important. Construction plans and specifications must be followed explicitly. To be noted is that there are very different anchorage schemes that are currently available. Some use concrete anchor blocks with embedded bolts which attach the geomembrane under a batten strip. Other anchorages are patented systems consisting of tensioned geomembranes attached to movable dead weights riding inside of stationary columns. Additional schemes are also possible. In each case the manufacturer's recommendations should be cited in the contract documents and must be followed completely.
4. The manufacturer/fabricator of the floating cover should provide a qualified and experienced representative on site to assist the installation contractor at the start of construction. After an initial start-up point, the representative should be available on an as needed basis, at the CQA engineer's request.

8.9 References

- AASHTO M252-90, "Corrugated Polyethylene Drainage Tubing"
- AASHTO M294-90, "Corrugated Polyethylene Pipe, 12- to 36-in. Diameter"
- ASTM D-698, "Moisture Density Relations of Soils and Soil/Aggregate Mixtures"
- ASTM D-792, "Specific Gravity and Density of Plastics by Displacement"
- ASTM D-1238, "Flow Rates of Thermoplastics by Extrusion Plastomer"
- ASTM D-1248, "Polyethylene Plastics and Extrusion Materials"
- ASTM D-1505, "Density of Plastics by the Density-Gradient Technique"
- ASTM D-1755, "Poly (Vinyl Chloride) (PVC) Resins"
- ASTM D-1777, "Measuring Thickness of Textile Materials"
- ASTM D-1785, "Poly (Vinyl Chloride) (PVC) Plastic Pipe, Schedules 40, 80 and 120"
- ASTM D-2122, "Determining Dimensions of Thermoplastic Pipe and Fittings"
- ASTM D-2241, "Poly (Vinyl Chloride) (PVC) Pressure Rated Pipe (SDR-Series)"
- ASTM D-2321, "Underground Installation of Thermoplastic Pipe for Sewers and Other Gravity - Flow Applications"
- ASTM D-2412, "External Loading Properties of Plastic Pipe by Parallel Plate Loading"
- ASTM D-2444, "Impact Resistance of Thermoplastic Pipe and Fittings by Means of a Tup (Falling Weight)"
- ASTM D-3034, "Type PSM Poly (Vinyl Chloride) (PVC) Sewer Pipe and Fittings"
- ASTM D-4254, "Maximum Index Density of Soils and Calculation of Relative Density"

ASTM D-4355, "Deterioration of Geotextiles from Exposure to Ultraviolet Light and Water (Xenon-Arc Type Apparatus)"

ASTM D-4533, "Trapezoidal Tearing Strength of Geotextiles"

ASTM D-4595, "Tensile Properties of Geotextiles by Wide Width Strip Method"

ASTM D-4632, "Breaking Load and Elongation of Geotextiles (Grab Method)"

ASTM D-4759, "Determining the Specification Conformance of Geosynthetics"

ASTM D-4833, "Index Puncture Resistance of Geotextiles, Geomembranes and Related Products"

ASTM D-4884, "Seam Strength of Sewn Geotextiles"

ASTM F-714, "Polyethylene (PE) Plastic Pipe (SDR-PR) Based on Outside Diameter"

ASTM G-26, "Operating Light-Exposure Apparatus (Xenon-Arc Type) With and Without Water for Exposure of Nonmetallic Materials"

ASTM G-53, "Operating Light- and Water-Exposure Apparatus (Fluorescent UV - Condensation Type) for Exposure of Nonmetallic Materials"

GRI GG1, "Geogrid Rib Tensile Strength"

U.S. Environmental Protection Agency (1991), "Inspection Techniques for the Fabrication of Geomembrane Field Seams," Technical Resource Document, U.S. EPA, EPA/530/SW-91/051.

Appendix A
List of Acronyms

| | |
|--------|---|
| AASHTO | American Association of State Highway and Transportation Officials |
| API | American Petroleum Institute |
| ASTM | American Society for Testing and Materials |
| ATV | All-Terrain Vehicle |
| CB | Cement-Bentonite |
| CERCLA | Comprehensive Environmental Response, Compensation, and Liability Act |
| CH | Fat Clay (ASTM D-2487) |
| CL | Lean Clay (ASTM D-2487) |
| CPE | Chlorinated Polyethylene |
| CQA | Construction Quality Assurance |
| CQC | Construction Quality Control |
| CSPE | Chlorosulfonated Polyethylene |
| CSPE-R | Chlorosulfonated Polyethylene (Scrim Reinforced) |
| ECRM | Erosion Control and Revegetation Mat |
| EIA | Ethylene Interpolymer Alloy |
| EIA-R | Ethylene Interpolymer Alloy - Reinforced |
| EPA | Environmental Protection Agency |
| EPDM | Ethylene Propylene Diene Monomer |
| FCEA | Fully Crosslinked Elastomeric Alloy |
| FML | Flexible Membrane Liner |
| FTB | Film Tear Bond |
| FTM | Federal Test Method |
| GCL | Geosynthetic Clay Liner |
| GRI | Geosynthetic Research Institute |

| | |
|-------|--|
| HDPE | High Density Polyethylene |
| IFAI | Industrial Fabrics Association International |
| LL | Liquid Limit |
| LLDPE | Linear Low Density Polyethylene |
| MARV | Mimimum Average Roll Value |
| MQA | Manufacturing Quality Assurance |
| MQC | Manufacturing Quality Control |
| NDT | Nondestructive Testing |
| NICET | National Institute for Certification in Engineering Technologies |
| PE | Professional Engineer or Polyethylene |
| PERM | Permanent Erosion Control and Revegetation Mat |
| PI | Plasticity Index |
| PL | Plastic Limit |
| PP | Polypropylene |
| PVC | Polyvinyl Chloride |
| QA | Quality Assurance |
| QC | Quality Control |
| RCRA | Resource Conservation and Recovery Act |
| SB | Soil-Bentonite |
| SC | Clayey Sand (ASTM D-2487) |
| SCB | Soil-Cement-Bentonite |
| SDR | Standard Dimension Ratio |
| TERM | Temporary Erosion Control and Revegetation Mats |
| TGA | Thermogravimetric Analysis |
| TRM | Turf Reinforcement and Revegetation Mat |
| USCS | Unified Soil Classification System |

| | |
|-------|-------------------------------|
| USP | U.S. Pharmaceutical |
| VLDPE | Very Low Density Polyethylene |

Appendix B

Glossary

- Activity**—Plasticity index (expressed as a percentage) divided by the clay content (expressed as a percentage and defined as material finer than 0.002 mm).
- Adhesion**—The state in which two surfaces are held together by interfacial forces which may consist of molecular forces or interlocking action or both: (a) measured in shear and peel modes for geomembranes, (b) measured by direct shear testing for geosynthetics-to-soil.
- Adhesive**—A chemical system used in the bonding of geomembranes. The adhesive residue results in an additional element in the seamed area. (Manufacturers and installers should be consulted for the various types of adhesives used with specific geomembranes).
- Aeolian Deposit**—Soil deposited by wind.
- Air Lance**—A commonly used nondestructive geomembrane test method performed with a stream of air forced through a nozzle at the end of a hollow metal tube to determine seam continuity and tightness of relatively thin, flexible geomembranes.
- All-Terrain Vehicles (ATVs)**—Mobile 3-, or 4-wheeled vehicles with low pressure balloon tires which are used to move small equipment and materials around project sites.
- Anchor Trench**—The terminus of most geosynthetic materials as they exit a waste containment facility usually consisting of a small trench where the geosynthetic is embedded and suitably backfilled.
- Antioxidants**—Primary types include phenols and amines that scavenge extraneous free radicals which cause degradation of geosynthetics. Secondary types include decomposed peroxides as a source of free radicals.
- Anvil**—In hot wedge seaming of geomembranes, the anvil is the wedge of metal above and below which the sheets to be joined must pass. The temperature controllers and thermocouples of most hot wedge devices are located within the anvil.
- Apertures**—The openings between adjacent sets of longitudinal and transverse ribs of geogrids and geonets.
- Appurtenances**—Detailed items related to the proper functioning of a waste containment facility, such as pipes, sumps, risers, manholes, vents, penetrations and related items.
- Atterberg Limits**—Liquid limit and plastic limit of a soil.
- Basis Weight**—A deprecated term for mass per unit area.
- Bedding Soil**—Compacted layer of soil immediately beneath a leachate collection pipe.
- Bentonite**—Any commercially processed clay material consisting primarily of the mineral group smectite.

- Berm**—The upper edge of an excavation which isolates one cell in a containment system from another. The ends of a geosynthetic are buried to hold them in place or to anchor the geosynthetics.
- Blocking**—Unintentional adhesion between geomembrane sheets or between a geomembrane and another surface usually occurring during storage or shipping.
- Blown Film**—An extrusion method for producing geomembranes whereby the molten polymer vertically exits a circular die in the form of a huge cylinder which is subsequently cut longitudinally, unfolded and rolled into cores.
- Blow-Out**—Geomembrane rolls or panels which have been unintentionally displaced from their correct position by wind.
- Bodied Chemical Fusion Agent**—A chemical fluid containing a portion of the parent geomembrane that, after the application of pressure and after the passage of a certain amount of time, results in the chemical fusion of two essentially similar geomembrane sheets, leaving behind only that portion of the parent material. (Manufacturers and installers should be consulted for the various types of chemical fluids used with specific geomembranes in order to inform workers and inspectors.)
- Bodied Solvent Adhesive**—An adhesive consisting of a solution of the liner compound used in the seaming of geomembranes.
- Boot**—A bellows-type covering of a penetration through a geomembrane to exclude dust, dirt, moisture, etc.
- Borrow Material**—Excavated material used to construct a component of a waste containment facility.
- Borrow Pit**—Excavation area adjacent to, or off-site, the waste containment facility from which soil will be taken for construction purposes.
- Buffing**—An inaccurate term often used to describe the grinding of polyethylene geomembranes to remove surface oxides and waxes in preparation of extrusion seaming.
- Calender**—A machine equipped with three or more heavy internally heated or cooled rolls, revolving in opposite direction. Used for preparation of continuous sheeting or plying up of rubber compounds and frictioning or coating of fabric with rubber or plastic compounds. [B. F. Goodrich Co. Akron, OH].
- Chemical-Adhesive Fusion Agent**—A chemical fluid that may or may not contain a portion of the parent geomembrane and an adhesive that, after the application of pressure and after passage of a certain amount of time, results in the chemical fusion of two geomembrane sheets, leaving behind an adhesive layer that is dissimilar from the parent liner material. (Manufacturers and installers should be consulted for the various types of chemical fluids used with specific geomembrane to inform workers and inspectors.)
- Chemical Fusion**—The chemically-induced reorganization in the polymeric structure of the surface of a polymer geomembrane that, after the application of pressure and the passage of a certain amount of time, results in the chemical fusion of two essentially similar geomembrane sheets being permanently joined together.

Chemical Fusion Agent—A chemical fluid that, after the application of the passage of a certain amount of time, results in the chemical fusion of two essentially similar geomembrane sheets without any other polymeric or adhesive additives. (Manufacturers and installers should be consulted for the various types of chemical fusion agents used with specific geomembranes to inform workers and inspectors.)

Chlorinated Polyethylene (CPE)—Family of polymers produced by the chemical reaction of chlorine with polyethylene. The resultant polymers presently contain 25-45% chlorine by weight and 0-25% crystallinity.

Chlorinated Polyethylene-Reinforced (CPE-R)—Sheets of CPE with an encapsulated fabric reinforcement layer, called a “scrim”.

Chlorosulfonated Polyethylene (CSPE)—Family of polymers produced by the reaction of polyethylene with chlorine and sulphur dioxide. Present polymers contain 23 to 43% chlorine and 1.0 to 1.4% sulphur. A “low water absorption” grade is identified as significantly different from standard grades.

Chlorosulfonated Polyethylene-Reinforced (CSPE-R)—Sheets of CSPE with an encapsulated fabric reinforcement layer, called a “scrim”.

Clay Content—The percentage of a material (dry weight basis) with an mean equivalent grain diameter smaller than a specified size (usually 0.002 or 0.005 mm).

Clod—Term referring to “chunks” of cohesive soil when used for compacted clay liners.

Coated Fabric—Fabric that has been impregnated and/or coated with a rubbery or plastic material in the form of a solution, dispersion, hot melt, or powder. The term also applies to materials resulting from the application of a pre-formed film to a fabric by means of calendering.

Coextrusion—A manufacturing process whereby multiple extruders eject molten polymer into a die for the purpose of distinguishing properties or materials across the thickness of the geosynthetic material, as in coextruded HDPE/VLDPE/HDPE geomembranes.

Compaction Curve—An experimentally obtained curve obtained by plotting dry unit weight versus molding water content, typically used with soil liners.

Composite Liner—A geomembrane placed directly on the surface of a compacted soil liner or geosynthetic clay liner.

Concentrate—Term commonly used for carbon black premixed with a carrier resin resulting in pellets which are added to the extruder in the manufacturing of geosynthetic materials.

Construction Quality Control (CQC)—A planned system of inspections that are used to directly monitor and control the quality of a construction project (EPA, 1986). Construction quality control is normally performed by the geosynthetics manufacturer or installer, or for natural soil materials by the earthwork contractor, and is necessary to achieve quality in the constructed or installed system. Construction quality control (CQC) refers to measures taken by the installer or contractor to determine compliance with the requirements for materials and workmanship as stated in the plans and specifications for the project.

- Construction Quality Assurance (CQA)**—A planned system of activities that provide assurance that the facility was constructed as specified in the design (EPA, 1986). Construction quality assurance includes inspections, verifications, audits, and evaluations of materials and workmanship necessary to determine and document the quality of the constructed facility. Construction quality assurance (CQA) refers to measures taken by the CQA organization to assess if the installer or contractor is in compliance with the plans and specifications for a project.
- Corrugated Pipe**—Built-up sections of HDPE drainage pipe manufactured by methods of corrugation, profiling or spirally wrapping small pipe around an internal core.
- CQC Personnel**—Individuals who work for contractor whose job it is to ensure that construction is taking place in accord with the plans and specifications approved by the permitting agency.
- Crystal Structure**—The geometrical arrangement of the molecules that occupy the space lattice of the crystalline portion of a polymer.
- Curing**—The strength gain over time of a chemically fused, bodied chemically fused, or chemical adhesive geomembrane seam due primarily to evaporation of solvents or crosslinking of the organic phase of the mixture.
- Curing Time**—The time required for full curing as indicated by no further increase in strength over time.
- Deltaic Deposit**—Soil deposited in a river delta.
- Denier**—A unit used in the textile industry to indicate the fineness of continuous filaments as applies to geotextiles. Fineness in deniers equals the mass in grams of 9000-m length of the filament.
- Density**—(a) For geosynthetics, the mass per unit volume of a polymeric material (since there is no void space, per se); and (b) for soils, the mass per total unit volume, including void space (note: if the mass is the total mass, i.e., solids plus water, the density is the total density or bulk density; if the mass is just the dry mass of solids, the density is the dry density of the soil).
- Desiccation**—Drying that is sufficient to change the properties, such as hydraulic conductivity, of the material.
- Design Engineer**—An organization or person who designs a waste containment facility that fulfills the operational requirements of the owner/operator, complies with accepted design practices for waste containment facilities and meets or exceeds the minimum requirements of the permitting agency.
- Destructive Tests**—Tests performed on geomembrane seam samples cut out of a field installation or test strip to verify specification performance requirements, e.g., shear and peel tests of geomembrane seams during which the specimens are tested to failure.
- Direction, Cross-Machine**—The direction perpendicular to the long, machine or manufactured direction.

Direction, Machine—The direction parallel to the long, machine or manufactured direction (synonyms, lengthwise, or long direction).

Dispersion—A qualitative term used to identify the degree of mixing of one component of a formulation within the total mass, e.g., carbon black dispersion.

Drive Rollers—Knurled or rubber rollers which grip two geomembrane sheets to be joined via applied pressure and propel the seaming device at a controlled rate of travel.

Dumbbell Shaped—Geomembrane test specimens in the shape of a dumbbell or dogbone, for subsequent tensile testing.

Dwell Time—The time required for a chemical fusion, bodied chemical fusion or adhesive seam to take its initial “tack”, enabling the two opposing geomembranes to be joined together.

Earthwork Contractor—The organization that is awarded the subcontract from the general contractor, or contract from the owner/operator, to construct the earthen components of the waste containment facility.

Embossing—A method of providing a textured, a roughened, surface to calendered geomembranes for the purpose of increasing its friction to adjacent materials.

Ethylene Interpolymer Alloy (EIA)—A blend of ethylene vinyl acetate and polyvinyl chloride resulting in a thermoplastic elastomer.

Ethylene Interpolymer Alloy-Reinforced (EIA-R)—Sheets of EIA with an encapsulated fabric reinforcement layer.

Extrudate—The molten polymer which is emitted from an extruder during seaming using either extrusion fillet or extrusion flat methods. The polymer is initially in the form of a ribbon, rod, bead or pellets.

Extruder—A machine with a driver screw for continuous forming of polymeric compounds by forcing through a die; two types are used in the manufacturing of geomembranes, flat die and blown film.

Extrusion Seams—A seam of two geomembrane sheets achieved by heat-extruding a polymer material between or over the overlap areas followed by the application of pressure.

Fabricator—The organization that factory assembles rolls of geosynthetic materials into large panels for subsequent field deployment.

Fabric, Composite—A textile structure produced by combining nonwoven, woven, or knit manufacturing methods.

Fabric, Knit—A textile structure produced by interloping one or more ends of yarn or comparable material.

Fabric, Nonwoven—For geotextiles, a planar and essentially random textile structure produced by bonding, interlocking of fibers, or both, accomplished by mechanical, chemical, thermal, or solvent means, and combinations thereof.

- Fabric, Reinforcement**—A fabric, scrim, and so on, used to add structural strength to a two-or more ply polymeric sheet. Such geomembranes are referred to as being supported.
- Fabric, Woven**—A planar textile structure produced by interlacing two or more sets of elements, such as yarns, fibers, roving, or filaments, where the elements pass each other, usually at right angles and one set of elements are parallel to the fabric axis.
- Factory Seams**—The seaming of geomembrane rolls together in a factory to make large panels to reduce the number of field seams.
- Field Seams**—The seaming of geomembrane rolls or panels together in the field thereby making a continuous liner system.
- Filament Yarn**—The yarn made from continuous filament fibers.
- Fill**—As used in textile technology refers to the threads or yarns in a fabric running at right angles to the warp. Also called filler threads.
- Filling Direction**—See Direction, cross-machine. Note: For use with woven geotextiles only.
- Film Tear Bond (FTB)**—Description of a destructive geomembrane seam test (shear or peel) wherein the sheet on either side of the seam fails rather than delamination of the seam itself.
- Filter Cloth**—A deprecated term for geotextile.
- Fines**—Material passing through the No. 200 sieve (openings of 0.075 mm)
- Fishmouth**—The uneven mating of two geomembranes to be joined wherein the upper sheet has excessive length that prevents it from being bonded flat to the lower sheet. The resultant opening is often referred to as a “fishmouth”.
- Flashing**—The molten extrudate or sheet material which is extruded beyond the die edge or molten edge of a thermally bonded geomembrane seam, also called “squeeze-out”.
- Flat Die**—An extrusion method for producing geomembranes whereby the molten polymer horizontally exists a flat die in the form of a wide sheet which is subsequently rolled onto cores.
- Flexible Membrane Liner (FML)**—Name previously given in EPA literature for the more generic term of geomembrane. The latter is used exclusively in this manual.
- Flood Coating**—The generous application of a bodied chemical compound, or chemical adhesive compound to protect exposed yarns in scrim reinforced geomembranes.
- Formulation**—The blending of several components (resin plus additives) to make a mixture for subsequent processing into a geosynthetic material.
- Fully Crosslinked Elastomeric Alloy (FCEA)**—A thermoplastic elastomeric alloy of polypropylene (PP) and ethylene-propylene diene monomer (EPDM).
- Gage**—Deprecated term for the thickness of a geosynthetic material.

- General Contractor**—The organization that is awarded a contract from the owner/operator to construct a waste containment facility.
- Geocell**—A three-dimensional structure filled with soil, thereby forming a mattress for increased bearing capacity and maneuverability on loose or compressible subsoils.
- Geocomposite**—A manufactured material using geotextiles, geogrids, geonets, and/or geomembranes in laminated or composite form.
- Geogrid**—A geosynthetic used for reinforcement which is formed by a regular network of tensile elements with apertures of sufficient size to allow strike-through of surrounding soil, rock, or other geotechnical materials..
- Geomembrane**—An essentially impermeable geosynthetic composed of one or more synthetic sheets.
- Geonet**—A geosynthetic consisting of integrally connected parallel sets of ribs overlying similar sets at various angles for planar drainage of liquids and gases.
- Geosynthetic Clay Liner (GCL)**—Factory manufactured, hydraulic barrier typically consisting of bentonite clay or other very low permeability material, supported by geotextiles and/or geomembranes which are held together by needling, stitching and/or chemical adhesives.
- Geosynthetics**—The generic term for all synthetic materials used in geotechnical engineering applications; the term includes geotextiles, geogrids, geonets, geomembranes, geosynthetic clay liners and geocomposites.
- Geotechnical Engineering**—The engineering application of geotechnics.
- Geotechnics**—The application of scientific methods and engineering principles to the acquisition, interpretation, and use of knowledge of materials of the earth's crust to the solution of engineering problems; it embraces the field of soil mechanics, rock mechanics, and many of the engineering aspects of geology, geophysics, hydrology, and related sciences.
- Geotextile**—A permeable geosynthetic comprised solely of textiles. Current manufacturing techniques produce nonwoven fabrics, knitted (non-tubular) fabrics, and woven fabrics.
- Glacial Till**—A soil of varied grain sizes deposited by glacial action.
- Gravel**—Material that will not pass through the openings of a No. 4 sieve (4.76 mm openings)
- Grinding**—The removal of oxide layers and waxes from the surface of a polyethylene sheet in preparation of extrusion fillet or extrusion flat seaming.
- Gun**—Synonymous term for hand held extrusion fillet device or hand held hot air device.
- Haunch Area**—The location of a buried pipe which extends for the lower 180° around the bottom outside of the pipe.
- Heat Bonded**—See Melt-bonded.

- Heat-Seaming**—The process of joining two or more thermoplastic geomembranes by heating areas in contact with each other to the temperature at which fusion occurs. The process is usually aided by a controlled pressure. In dielectric seaming the heat is induced by means of radio-frequency waves.
- High Density Polyethylene (HDPE)**—A polymer prepared by low-pressure polymerization of ethylene as the principal monomer and having the characteristics of ASTM D-1348 Type III and IV polyethylene. Such polymer resins have density greater than or equal to 0.941 g/cc as noted in ASTM D-1248.
- Hook Blade**—A shielded knife blade confined in such a way that the blade cuts upward or is drawn toward the person doing the cutting to avoid damage to underlying sheets.
- Hydraulic Conductivity**—The rate of discharge of water under laminar flow conditions through a unit cross-sectional area of a porous medium under a unit hydraulic gradient and standard temperature conditions (20°C).
- Initial Reaction Time**—(See dwell time).
- Installation Contractor**—The organization that is awarded a subcontract from the general contractor or owner/operator, to install geosynthetic materials in the waste containment facility.
- Kneading Compaction**—Compaction of a soil liner whereby a foot or prong is repeatedly passed into and through a lift of soil.
- Lacustrine Deposit**—A soil deposited in a stagnant body of water, e.g., lake.
- Lapped Seam**—A seam made by placing one surface to be joined partly over another surface and bonding the overlapping portions.
- Leachate**—Liquid that has percolated through or drained from solid waste or other man-emplaced materials and contains soluble, partially soluble, or miscible components removed from such waste.
- Let-Down**—Term used for the addition of carbon black powder or concentrated pellets into an extruder in the manufacture of geosynthetic materials.
- Lift**—Term applied to the construction of a discrete layer of a soil liner, usually 150 to 225 mm (6 to 9 in.) in thickness.
- Liner**—A layer of emplaced materials beneath a surface impoundment or landfill which serves to restrict the escape of waste or its constituents from the impoundment or landfill. The term can apply to soil liners, geomembranes or geosynthetic clay liners.
- Linear Low Density Polyethylene (LLDPE)**—A polyethylene material produced by a low pressure polymerization process with random incorporation of comonomers to produce a density of 0.915 to 0.930 g/cc.
- Liquid Limit (LL)**—The water content corresponding to the arbitrary limit between the liquid

and plastic states of consistency of a soil .

Manhole—A vertical pipe rising from a sump area through the waste mass and eventually penetrating the cover for the purpose of leachate removal.

Manufacturer—The organization that manufactures geosynthetic materials used at a waste containment facility.

Manufacturing Quality Assurance (MQA)—A planned system of activities that provide assurance that the materials were constructed as specified in the certification documents and contract plans. MQA includes manufacturing facility inspections, verifications, audits and evaluation of raw materials and geosynthetic products to assess the quality of the manufactured materials. MQA refers to measures taken by the MQA organization to determine if the manufacturer is in compliance with the product certification and contract plans for a project.

Manufacturing Quality Control (MQC)—A planned system of inspections that is used to directly monitor and control the manufacture of a material which is factor originated. MQC is normally performed by the manufacturer of geosynthetic materials and is necessary to ensure minimum (or maximum) specified values in the manufactured product. MQC refers to measures taken by the manufacturer to determine compliance with the requirements for materials and workmanship as stated in certification documents and contract plans.

Mass Per Unit Area—The proper term to represent and compare the amount of material per unit area (units are oz./yd.² or g/m²). Often called “weight” or “basis weight”.

Medium Density Polyethylene (MDPE)—A polymer prepared by low-pressure polymerization of ethylene as the principal monomer and having the characteristics of ASTM D-1348 Type II polyethylene. Such polymer resins have density less than 0.941 g/cc as noted in ASTM D-1248.

Melt-Bonded—Thermally bonded by melting the fibers to form weld points.

Membrane—A continuous sheet of material, whether prefabricated as a geomembrane or sprayed or coated in the field, as a sprayed-on asphalt/polymer mixture.

Minimum Average Roll Value (MARV)—A statistical value of a particular test property which embraces the 95% confidence level of all possible values of that property. For a normally distributed set of data it is approximately the mean value plus and minus two standard deviations.

Modified Compaction—A laboratory technique that produces maximum dry unit weights approximately equal to field dry units weights for soils that are well compacted using the heaviest compaction equipment available (ASTM D-1557).

Mouse—Synonymous term for hot wedge, or hot shoe, seaming device.

MQA/CQA Certifying Engineer—The individual who is responsible for certifying to the owner/operator and permitting agency that, in his or her opinion, the facility has been constructed in accord with the plans and specifications and MQA/CQA document approved by the permitting agency.

- MQA/CQA Engineer**—The individual who has overall responsibility for manufacturing quality assurance and construction quality assurance.
- MQA/CQA Personnel**—Those individuals responsible for making observations and performing field tests to ensure that the facility is constructed in accord with the plans and specifications approved by the permitting agency.
- MQA/CQA Plan**—A written plan, or document, prepared on behalf of the owner/operator which includes a detailed description of all MQA/CQA activities that will be used during materials manufacturing and construction to manage the installed quality of the facility.
- Needle-Punched**—A nonwoven geotextile which is mechanically bonded by needling with barbed needles.
- NICET**—An acronym for the National Institute for Certification in Engineering Technologies, an organization who administers examinations for geosynthetic and earthen materials for waste containment facilities. [NICET, 1420 King Street, Alexandria, VA 22314]
- Nondestructive Test**—A test method which does not require the removal of samples from, nor damage to, the installed liner system. The evaluation is done in an in-situ manner. The results do not indicate the seam's mechanical strength but are performed for examination for the seam's continuity.
- Nonwoven**—See Fabric, nonwoven.
- Normal Direction**—For geotextiles, the direction perpendicular to the plane of a geotextile.
- Outliers**—Experimental data points which do not fit into the anticipated and/or required maxima, or minima, specified values.
- Owner/Operator**—The organization that will own and operate the disposal unit.
- Owner's Representative**—The official representative who is responsible for coordinating schedules, meetings and field activities.
- Oxide Layer**—The reacting of atmospheric oxygen with the surface of a polymer geomembrane.
- Padfoot Roller**—Footed, or padded, roller typically consisting of 4.0 in. long pads used to compact soil liners.
- Panels**—The factory fabrication of geomembrane rolls into relatively large sections, or panels, so as to reduce the number of field seams.
- Peel Test**—A geomembrane seam test wherein the seam is placed in a tension state as the geomembrane ends are pulled apart.
- Permeability**—(1) The capacity of a porous medium to conduct or transmit fluid; (2) the amount of liquid moving through a barrier in a unit time, unit area, and unit gradient not normalized for, but directly related to, thickness. See Hydraulic Conductivity.
- Permitting Agency**—Often a state regulatory agency but may include local or regional agencies and/or other federal agencies.

Permittivity—For a geotextile, the volumetric flow rate of water per unit cross-section area, per unit head, under laminar flow conditions, in the normal direction through the fabric.

pH—A measure of the acidity or alkalinity of a solution; numerically equal to the logarithm of the reciprocal of the hydrogen ion concentration in gram equivalents per liter of solution. pH is represented on a scale of 0 to 14; 7 represents a neutral state; 0 represents the most acid, and 14 the most alkaline.

Pinholes—Very small imperfections in geomembranes which may allow for escape of the contained liquid.

Piping—The phenomenon of soil fines migrating out of a soil mass by flow of liquid leaving a small channel, or pipe, in the upstream soil mass.

Plastic—A material that contains as an essential ingredient one or more organic polymeric substances of large molecular weight which is solid in its finished state and at some stage in its manufacture or processing into finished articles can be shaped by flow [ASTM].

Plastic Index (PI)—The numerical difference between liquid and plastic limits, i.e., LL-PL.

Plastic Limit (PL)—The water content corresponding to the arbitrary limit between the plastic and solid states of consistency of a soil.

Plasticizer—A plasticizer is a material, frequently “solventlike,” incorporated in a plastic or a rubber to increase its ease of workability, its flexibility, or distensibility. Adding the plasticizer may lower the melt viscosity, the temperature of the second-order transition, or the elastic modulus of the polymer. Plasticizers may be monomeric liquids (phthalate esters), low-molecular-weight liquid polymers (polyesters), or rubbery high polymers (EVA). The most important use of plasticizers in geosynthetics is with PVC geomembranes, where the choice of plasticizer will dictate under what conditions the liner may be used.

Plugging—The phenomenon of soil fines migrating into and clogging the voids of larger particle sized soils within a soil mass or geotextile filter.

Ply—Individual layer of material, usually sheet of geomembrane, which is laminated to another, or several, layers to form the complete geomembrane.

Ply Adhesion—The bonding force required to break the adhesive bond of one layer, or material, to another. It is usually evaluated by some type of tension peel test.

Polyester Fiber—Generic name for a manufactured fiber in which the fiber-forming substance is any long-chain synthetic polymer composed of an ester of a dihydric alcohol and terephthalic acid.

Polyethylene (PE)—A polyolefin formed by bulk polymerization (for low density) or solution polymerization (for high density) where the ethylene monomer is placed in a reactor under high pressure and temperature. The oxygen produces free radicals which initiate the chain polymerization. For solution polymerization the monomer is first dissolved in an inert solvent. Catalysts are sometimes required to initiate the reaction.

Polymer—A macromolecular material formed by the chemical combination of monomers having

either the same or different chemical composition. Plastics, rubbers, and textile fibers are all high-molecular-weight polymers.

Polymeric Liner—Plastic or rubber sheeting used to line disposal sites, pits, ponds, lagoons, canals, and so on.

Polyolefin—A family of polymeric materials that includes polypropylene and polyethylene, the former being very common in geotextiles, the latter in geomembranes. Many variations of each exist.

Polypropylene—A polyolefin formed by solution polymerization as was described for high density polyethylene.

Polyvinyl Chloride (PVC)—A synthetic thermoplastic polymer prepared from vinylchloride. PVC can be compounded into flexible and rigid forms through the use of plasticizers, stabilizers, fillers, and other modifiers; rigid forms used in pipes and well screens; flexible forms used in manufacture of geomembranes.

Pressure Rollers—Rollers accompanying a seaming technique which apply pressure to the opposing geomembrane sheets to be joined. They closely follow the actual melting process and are self-contained within the seaming device.

Pressurized Dual Seam—A thermal fusion method of making a geomembrane whereby a unbonded space is left between two parallel bonded tracks. The unbonded space is subsequently used for a nondestructive air pressure test.

Proctor Test—The tests utilized to obtain a laboratory compaction curve. Synonymous to compaction test.

Puckering—A heat related sign of localized strain caused by improper seaming using extrusion or fusion methods. It often occurs on the bottom of the lower geomembrane and in the shape of a shallow inverted "V".

Pugmill—A mechanical device used for mixing of dry soil materials.

Quality Assurance (QA)—A planned system of activities that provide assurance that the facility was constructed as specified in the design.

Quality Control (QC)—A planned system of inspections that are used to directly monitor and control the quality of a construction project.

Reclaim—Small pieces, or chips, of previously used polymer materials which are entered into the processing of a geosynthetic material. Synonymous with "reprocess" and "recycle".

Record Drawings—Drawings which document the actual lines and grades and conditions of each component of the disposal unit. Synonymous with "as-built" drawings.

Regrind—Small pieces, or chips, of previously fabricated geosynthetic material which are re-entered into the processing of the same type of geosynthetic material, synonymous with "rework".

Residual Soil—Soil formed in place from weathering of parent rock.

- Risers**—Pipelines extending from primary or secondary leachate collection sumps up the sideslope of the facility and exiting to a shed or manhole.
- Rolling Bank**—A charge of molten polymer used in the calendering production method of geomembranes for the purpose of directing the flow of polymer in the desired roll direction.
- Scrim Designation**—The weight of number of yarns of fabric reinforcement per inch of length and width, e.g., a 10 × 10 scrim has 10 yarns per inch in both the machine and cross machine directions.
- Scrim (or Fabric) Reinforcement**—The fabric reinforcement layer used with some geomembranes for the purpose of increased strength and dimensional stability.
- Sealant**—A viscous chemical used to seal the exposed edges of scrim reinforced geomembranes. (Manufacturers and installers should be consulted for the various types of sealant used with specific geomembranes).
- Sealed Double Ring Infiltrometer (SDRI)**—A device used for measuring in-situ hydraulic conductivity of a test pad for a soil liner.
- Seam Strength**—Strength of a seam of liner material measured either in shear or peel modes. Strength of the seams is reported either in absolute units (e.g., pounds per inch of width) or as a percent of the strength of the geomembrane.
- Seaming Boards**—Smooth wooden planks placed beneath the area to be seamed to provide a uniform resistance to applied roller pressure in the fabrication of geomembrane seams.
- Selvage**—The longitudinal edges of woven geotextile in which the weft yarns fold back upon themselves. In fabric reinforced geomembranes selvage refers to edge of the rolls where no scrim is present.
- Shear Test**—A geomembrane seam test wherein the seam is placed in a shear state as the geomembrane ends are pulled apart.
- Sheepsfoot Roller**—Footed, or pronged, roller typically consisting of 8.0 in. long feet used to compact soil liners.
- Sheeting**—A form of plastic or rubber in which the thickness is very small in proportion to length and width and in which the polymer compound is present as a continuous phase throughout, with or without fabric, synonymous with geomembrane.
- Shielded Blade**—A knife within a housing which protects the blade from being used in an open fashion, i.e., a protected knife.
- Slope**—Deviation of a surface from the horizontal expressed as a percentage, by a ratio, or in degrees. In engineering, usually expressed as a percentage of vertical to horizontal change [EPA].
- Slurry Wall**—A construction technique whereby a vertical sided trench is supported by means of the hydrostatic pressure of a clay-water suspension (“slurry”) placed within it.

- Smectite**—A group of expandable clay minerals with a very large ratio of surface area to mass, a large negative surface charge, a high cation exchange capacity, and a high shrink-swell potential.
- Soil Liners**—Low-hydraulic-conductivity materials constructed of earthen materials that usually contain a significant amount of clay.
- Solvent, Bodied Solvent and Solvent Adhesive**—See Chemical Fusion, Bodied Chemical Fusion and Chemical Adhesive.
- Spotting**—The final placement, or positioning, of a geomembrane roll or panel prior to field seaming.
- Spread-Coating**—A manufactured process whereby a polymeric material is spread in a continuous fashion on a geotextile substrate thereby forming a reinforced geomembrane composite.
- Squeeze-Out**—See “flashing”.
- Standard Compaction**—A laboratory technique which produces maximum dry unit weights approximately equal to field dry unit weights for soil that are well compacted using modest-sized compaction equipment.
- Staple**—Short fibers in the range 0.5 to 3.0 in. (1 cm to 8 cm) long.
- Staple Yarn**—Yarn made from staple fibers.
- Stinger**—A long steel rod on the end of a front end loader or fork lift which is inserted into the core of a roll of geosynthetic material for the purpose of lifting and maneuvering.
- Stress Crack**—An external or internal crack in a plastic caused by tensile stresses less than its short-time mechanical strength. Note: The development of such cracks is frequently accelerated by the environment to which the plastic is exposed. The stresses which cause cracking may be present internally or externally or may be combinations of these stresses.
- Strike-through**—The penetration of one material into and/or through the openings of an adjacent planar material.
- Substrate**—The layer, or unit, that is immediately beneath the layer under consideration.
- Sumps**—A low area in a waste facility which gravitationally collects leachate from either the primary or secondary leachate collection system.
- Superstrate**—The layer, or unit, that is immediately above the layer under consideration.
- Support Sheeting**—See Fabric reinforcement.
- Tack**—Stickiness of a geomembrane or the temporarily welding of geomembranes together.
- Tenacity**—The fiber strength on a grams per denier basis.
- Tensiometer**—A field measuring device containing a set of opposing grips used to place a

geomembrane sheet or seam in tension for evaluating its strength.

Testing Laboratory—The testing laboratory(s) providing testing services to verify physical, mechanical, hydraulic or endurance properties of the materials used to construct the waste containment facility.

Test Pads—Prototype layer or layers of soil materials constructed for the purpose of simulating construction conditions and/or measuring performance characteristics. Test pads are most frequently used to verify that the materials and methods of construction proposed for a soil liner will lead to development of the desired low hydraulic conductivity.

Test Strips—Trial sections of seamed geomembranes used (1) to establish machine settings of temperature, pressure and travel rate for a specific geomembrane under a specific set of atmospheric conditions for machine-assisted seaming and (2) to establish methods and materials for chemical and chemical adhesive seams under a specific set of atmospheric conditions.

Test Welds—See “test strips”.

Tex—Denier multiplied by 9 and is the weight in grams of 1000 m of yarn.

Textured Sheet—Polyethylene geomembranes which are produced with a roughened surface via coextrusion, impingement or lamination so as to create a high friction surface(s).

Thermal Fusion—The temporary, thermally-induced reorganization in the polymeric make-up of the surface of a polymeric geomembrane that, after the application of pressure and the passage of a certain amount of time, results in the two geomembranes being permanently joined together.

Thermoplastic Polymer—A polymer that can be heated to a softening point, shaped by pressure, and cooled to retain that shape. The process can be done repeatedly.

Thermoset Polymer—A polymer that can be heated to a softening point, shaped by pressure, and, if desired, removed from the hot mold without cooling. The process cannot be repeated since the polymer cannot be resoftened by the application of heat.

Tramponing—The lifting of a geomembrane off of its subbase material due to thermal contraction and inadequate slack which can occur at the toe of slope or in corners of a facility.

Transmissivity—For a geotextile, the volumetric flow rate per unit thickness under laminar flow conditions, within the in-plane direction of the fabric.

Transverse Direction—A deprecated term for cross-machine direction.

Tremie—A method of hydraulic placement of soil, or other material, under a head of water.

Ultraviolet Degradation—The breakdown of polymeric structure when exposed to natural light.

Unsupported Geomembrane—A polymeric geomembrane consisting of one or more piles without a reinforcing-fabric layer or scrim.

- Vacuum Box**—A commonly used type of nondestructive test method which develops a vacuum in a localized region of a geomembrane seam in order to evaluate the seam's tightness and suitability.
- Veneer Reinforcement**—Geogrid or geotextile reinforcement layer(s) which placed in the soil covering a geomembrane for the purpose of side slope stabilization.
- Very Low Density Polyethylene (VLDPE)**—A linear polymer of ethylene with other alpha-olefins with a density of 0.890 to 0.912 g/cc.
- Virgin Ingredients**—Components of a geosynthetic formulation which have never been used in a prior formulation or product.
- Warp**—In textiles, the lengthwise yarns in a woven fabric.
- Waxes**—The low molecular weight components of some polyethylene compounds which migrate to the surface over time and must be removed by grinding (for polyethylene) or be mixed into the melt zone using thermal seaming methods.
- Weft**—A deprecated term for cross-machine direction.
- Wicking**—The phenomenon of liquid transmission within the fabric yarns of reinforced geomembranes via capillary action.
- Width**—For a geotextile, the cross-direction edge-to-edge measurement of a fabric in a relaxed condition on a flat surface.
- Woof**—A deprecated term for cross-machine direction.
- Woven**—See Fabric, woven.
- Woven, Monofilament**—The woven geotextile produced with monofilament yarns.
- Woven, Multifilament**—The woven geotextile produced with multifilament yarns.
- Woven, Slit-Film**—The woven fabric produced with yarns produced from slit film.
- Woven, Split-Film**—See Woven, slit-film.
- Yarn**—A generic term for continuous strands of textile fibers or filaments in a form suitable for knitting, weaving, or otherwise intertwining to form a textile fabric. Yarn may refer to (1) a number of fibers twisted together, (2) a number of filaments laid together without twist (a zero-twist yarn), (3) a number of filaments laid together with more or less twist, or (4) a single filament with or without twist (a monofilament).
- Zero Air Voids Curve**—A curve that relates dry unit weight to water content for a saturated soil that contains no air.

Appendix C

Index

- Acceptable Zone 30-34
- Access Ramps 268-270
- Air Lance 162, 163, 166
- Anchor Trenches 266-268
- As-Built Drawings 13-14
- Backhoe 244
- Backscattering 59-60
- Bentonite 19, 40-42, 68-72
- Bentonite 176-177
- Bentonite Blankets 174
- Bentonite Mats 174
- Bentonite Slurry 241-243
- Boutwell Test- see Two Stage Borehole Test
- Butterfly Seam 214, 215
- Calcium Carbide Gas Pressure Tester 54
- Certification 14
- Chlorosulfonated Polyethylene 107-110, 129-131
 - Additives 109
 - Calendering 129-131
 - Carbon Black 109
 - Fillers 109
 - Master Batch 129
 - Panel Fabrication 131
 - Reinforcing Scrim 109-110
 - Reinforcing Scrim 129
 - Resin 107-108
 - Scrim 129
- Clamshell 245
- Clay Blankets 174
- Clay Mats 174
- Compacted Soil Liners
 - Activity 39
 - Atterberg Limits 62-63, 65, 73-75
 - Bentonite-Soil Blends 19
 - Borrow Sources Inspection 61-67
 - Clay Content 39-41, 63
 - Clod Pulverization 68
 - Clod Size 39-40, 75
 - Compaction Equipment 76-78
 - Compaction Principles 46-51
 - Compaction Requirements and Curve 24-33, 49-51, 62-63, 65, 73-74
 - Compactive Energy 48-51
 - Construction Requirements 21-24
 - Corrective Action 75, 82
 - Coverage (Compactor) 77
 - Critical CQC and CQA Issues 21
 - Density (Measurement) 57-60, 65, 78-82
 - Desiccation 53, 86
 - Freezing 53, 86-88
 - Homogenizing Soils 68
 - Compacted Soil Liners (continued)
 - Hydraulic Conductivity (In Situ) 91-95
 - Hydraulic Conductivity Testing 63-65, 75, 82-85, 91-95
 - Lift Bonding 52
 - Lift Thickness 75-76, 85
 - Liquid Limit 62-63, 65, 73-75
 - Materials 23, 35-45, 61-67, 73-75
 - Maximum Particle Size 39, 62-63, 65, 73-75
 - Natural Mineral Materials 19
 - Outliers 80-82
 - Oversight (Construction) 74, 79
 - Oversized Particle Removal 68
 - Pass/Fail Decision 85
 - Passes of Compaction 77-79
 - Penetrations- Repair 85
 - Percent Fines 37, 62-63, 65, 73-75
 - Percent Gravel 38, 62-63, 65, 73-75
 - Placement of Soil 72-73, 75-76
 - Plasticity Index 62-63, 65, 73-75
 - Plastic Limit 62-63, 65, 73-75
 - Plasticity 35-37, 41, 62-63, 65, 73-75
 - Preprocessing 23, 67-72
 - Protection 24, 53, 86-88
 - Sampling Pattern 78, 80
 - Scarification 73
 - Stockpiling Soils 72
 - Subgrade Preparation 22
 - Test Pads 34-35, 88-95
 - Types 19
 - Water (Excess Surface) 88
 - Water Content (Adjustment) 67-68
 - Water Content (Measurement) 53-55, 62, 65, 78-82
 - Water Content (Molding) 42-45
 - Water Content-Density Specification 30-34, 49-51, 63-64
 - Compaction Curve 24-26, 63
 - Compaction Tests 26-29
 - Construction Fabrics 202
 - Construction Quality Assurance 1, 2-3
 - Construction Quality Control 1, 2
 - CQC Personnel 7
 - Design Engineer 5
 - Diaphragm-Wall Construction 249, 250
 - Direct Heat Drying of Soil 54
 - Document Control 14
 - Documentation 11
 - Drainage Geocomposites 226-228

- Drainage Materials 191-200
 - Borrow Sources 196
 - Compaction 198-199
 - Placement 197-198
 - Processing 196-197
 - Protection 199-200
- Drainage Trenches 197
- Drawings of Record 13-14
- Drive Cylinder 57, 59
- Earthwork Contractor 7
- Edge Drains 226, 228
- Electric Field 163, 164
- Electric Sparking 164
- Electric Wire 163, 164, 166
- Fabricator 6
- Filter Cake 239
- Filter Fabrics 202
- Filters (Soil) 193-194
- Filtrate Loss 243
- Flash Operation 242
- Flat Seam 214, 215, 216
- Flexible Membrane Liners- see Geomembranes
- Floating Geomembrane Covers 278-280
- Footed Roller 47-48
- Free Swell of Bentonite 69-70
- General Contractor 6
- Geocomposites 225-233
 - Acceptance and Conformance Testing 231-232
 - Covering 233
 - Handling 231-232
 - Joining 232-233
 - Manufacturing 228-231
 - Packaging 231
 - Placement 232
 - Shipment 231
 - Storage at Field Site 231
 - Storage at Manufacturing Facility 231
 - Types 225-227
- Geogrid 271, 273-274
- Geomembrane Walls 238
- Geomembranes
 - Acceptance and Conformance Testing 135-136
 - Adhesive Seaming 142-146
 - Anchor Trenches 266-268
 - Blocking 138
 - Bodied Chemical 143, 144
 - Chemical 143
 - Chemical Adhesive 143, 144
 - Chemical Fusion 142-146
 - Chemical Processes 142
 - Chlorinated Polyethylene 110
 - Coextruded 105
 - Coextrusion 123-124
- Geomembranes (continued)
 - Contact Adhesive 143, 144
 - Control Charts 153
 - Crack 138
 - Craze 138
 - Critical Cone Heights 167
 - Destructive Test Methods 150-161
 - Distort 138
 - Dual Hot Wedge 143
 - Ethylene Interpolymer Alloy 110
 - Ethylene-Propylene Diene Monomer 105-106
 - Expansion/Contraction 139-140, 168, 170
 - Extrusion Fillet 144
 - Extrusion Flat 144
 - Extrusion Welding 142-146
 - Field Seaming Methods 141-146
 - Field Tensiometer 147-148
 - Fillet-Type 143
 - Film Tear Bond 156, 158
 - Fixed Increment Sampling 151-152
 - Flat-Type 143
 - Foaming Agent 105
 - Formulations 99
 - Fully Crosslinked Elastomeric Alloys 106
 - Geosynthetic Covering 170
 - Hot Air 144
 - Hot Shoe 144
 - Hot Wedge 144
 - Joining 141-150
 - Melt Bonding 142-146
 - Method of Attributes 153
 - Non-Film Tear Bond 156, 158
 - Nondestructive Test Methods 161-166
 - Peel Strength Efficiency 159
 - Peel Testing 157-160
 - Placement 136
 - Polypropylene 105
 - Polypropylene 110
 - Randomly Selected Sampling 152-153
 - Reclaimed 113
 - Recycled 113
 - Regrind 111-113
 - Rework 111-113
 - Sampling Strategies 151-153
 - Seam Shear Efficiency 156-157
 - Seaming 141-150
 - Shear Testing 153-157
 - Single Hot Air 143
 - Slack 139
 - Soil Backfilling of Geomembranes 167-170

Geomembranes (continued)

Spotting 140
 Spread Coated Geomembranes
 131-132
 Sticking/Cracking 138
 Subgrade (Subbase) 136-138
 Test Strips 146-150
 Textured 105
 Textured Sheet 117-119, 121-123
 Thermal Fusion 142-146
 Thermal Processes 142
 Trampolining 139
 Trial Seams 146-150
 Trim Reprocessing 111-113
 Types 99
 Wind 140-141

Geonets 218-226

Acceptance and Conformance Testing
 222
 Extruder 218
 Foamed Rib Geonet 221
 Handling 221-223
 Joining 223-225
 Manufacturing 218, 220-221
 Packaging 222
 Placement 223
 Reclaimed 221
 Recycled 221
 Regrind 221
 Resins 218, 221
 Rework 221
 Shipment 222
 Solid Rib Geonet 221
 Storage at Manufacturing Facility
 222
 Storage at the Site 222

Geopipe 253-261

Conformance Testing and Acceptance
 259-260
 High Density Polyethylene 254
 High Density Polyethylene Corrugated
 257-258
 High Density Polyethylene Smooth

Wall 256-257

Packaging 259
 Placement 261
 Polyvinyl Chloride 254-256
 Profiled 257
 Rework 255
 Shipment 259
 Storage at Field Site 259
 Storage at Manufacturing Facility
 259

Geospacers 225**Geosynthetic Clay Liners**

Acceptance and Conformance Testing
 184-185

Adhesive Bound 174, 175

Backfilling 188-189

Bentonite 176-177

Covering 188-189

Handling 180-185

Installation 185-188

Joining 187

Manufacturing 176-179

Needle Punched 174, 175

Placement 185-187

Repairs 187-188

Shipment 181, 182

Stitch Bonded 174, 175

Storage at the Manufacturing Facility
 180-181

Storage at the Site 181, 183-184

Types 174-176

**Geosynthetic Erosion Control Materials
275-278****Geotextile Reinforcement 271-273****Geotextiles 202-218**

Acceptance and Conformance Testing
 212-213

Additives 204-206

Backfilling 217-218

Covering 217-218

Fiber Types 206

Handling 210-214

Heat Bonded 207, 209

Knit 207

Manufacturing 202-210

Needlepunched 207, 208

Nonwoven 207, 208-209

Placement 213-214

Polyester 204-205

Polypropylene 204

Protective Wrapping 210

Reclaimed 209-210

Recycled 209-210

Repairs 217

Resins 204-206

Seam Tests 217

Seaming 214-217

Shipment 212

Storage at Field Site 211, 212

Storage at Manufacturing Facility
 210-212

Types 207

Woven 207, 208

Hazen's Formula 191

High Density Polyethylene 99-103, 113-119,
 254, 256-258

Additives 103

- High Density Polyethylene (continued)
- Blown Film 113, 115-117
 - Carbon Black 101-103
 - Coextrusion 117, 118
 - Corrugated Pipe 257-258
 - Extruder 113
 - Flat Horizontal Die 113, 114-115
 - Impingement 118, 119
 - Lamination 118, 119
 - Reclaimed Material 101
 - Regrind Chips 101
 - Resin 100-101
 - Rework Chips 101
 - Smooth Wall Pipe 256-257
- Impact Compaction 46
- Installation Contractor 6-7
- J Seam 214, 215
- Kneading Compaction 46
- Line of Optimums 51
- Manholes 261-264
- Manufacturer 5
- Manufacturing Quality Assurance 1, 2
- Manufacturing Quality Control 1, 2
- Mechanical Point Stress 162, 163, 166
- Meetings 15-17
- Pre-Bid 15
 - Preconstruction 16-17
 - Progress 17
 - Resolution 15-16
- Methylene Blue Test 71
- Microwave Oven Drying of Soil 53
- Minimum Average Roll Value 207
- MQA/CQA Certifying Engineer 9
- MQA/CQA Engineer 7-8
- MQA/CQA Personnel 8
- MQA/CQA Plan 11
- Nuclear Moisture-Density Tests 54-55, 58-60
- Owner's Representative 5
- Owner/Operator 3
- Penetrations 264-266
- Percent Compaction 27
- Permitting Agency 3
- Personnel Qualifications 10
- Pick Test 162, 163
- Piggybacking 270
- Pipe Boot 264
- Pipe Penetrations 265
- Pipe- see Geopipe
- Plastic Concrete 250-251
- Plastic Pipe- see Geopipe
- Polyvinyl Chloride 106-107, 124-129, 254-256
- Additives 107
 - Blocking 124
 - Calendering 124, 126-127
 - Filler 107
- Polyvinyl Chloride (continued)
- Manufacturing 124-129
 - Panel Fabrication 127-129
 - Pipe 254-256
 - Plasticizer 106-107
 - Resin 106
- Prayer Seam 214, 215, 216
- Prefabricated Bentonite Clay Blankets 174
- Pressurized Dual Seam 162, 163, 166
- Pugmill Mixing of Bentonite 70-71
- Records- Storage 14
- Reinforcement Materials 270-274
- Reports 11-13
- Corrective Measures 13
 - Daily Inspection 11
 - Daily Summary 11-12
 - Inspection 12-13
 - Problem Identification 13
 - Testing 12-13
- Risers 261-264
- Rubber Balloon Density Test 57-58
- Sample Custody 17
- Sand Cone 56-57
- Sealed Double Ring Infiltrometer 91-93
- Sheet Drains 226, 227
- Sheet Pile Walls 237-238
- Slurry Trench Cutoff Walls 239-250
- Slurry Trench- see Vertical Cutoff Walls
- Slurry Wall- see Vertical Cutoff Walls
- Static Compaction 46-47
- Stinger 181, 212, 222
- Strip Drains 226, 227
- Sumps 261-264
- Test Pads 34-35, 88-95
- Testing Laboratory 9
- Two Stage Borehole Test 93-94
- Ultrasonic Impedance Plane 163, 164-165, 166
- Ultrasonic Methods 163, 164-165, 166
- Ultrasonic Pulse Echo 163, 164, 166
- Ultrasonic Shadow Method 163, 165, 166
- Vacuum Chamber (Box) 163, 164, 166
- Veneer Reinforcement 270
- Venturi Mixer 242
- Vertical Cutoff Walls 235-252
- Caps 251
 - Cement-Bentonite Cutoff Walls 248-250
 - Construction 241-251
 - CQA Requirements 251-252
 - Examples 235-236
 - Excavation of Slurry Trench 243-244
 - Geomembrane in Slurry Trench Cutoff Walls 250
 - Mobilization 241
 - Site Preparation 241

Vertical Cutoff Walls (continued)
Slurry Density 242-243
Slurry Preparation and Properties
241-243
Slurry Viscosity 243
Soil-Bentonite Backfill 244-248
Types 237-241
Very Low Density Polyethylene 103-105,
120-123
Additives 105
Blown Film 121
Carbon Black 104-105
Coextrusion 122
Flat Horizontal Die 120-121
Impingement 122
Lamination 122
Regrind Chips 104
Resin 103-104
Rework Chips 104
Vibratory Compaction 46-47
Water Content Measurement for Soil 53-55
Weather 17
Wick Drains 226, 227
Work Stoppages 17-18

Available Companion Document of Standards
To
Quality Control and Quality Assurance for Waste Containment Facilities,
EPA/600/R-93/182

A compilation of standards referenced in this document (*Quality Control and Quality Assurance for Waste Containment Facilities*, EPA/600/R-93/182) is available from The American Society for Testing and Materials (ASTM). It is intended as a companion for this document and for engineers and researchers who are involved with quality assurance and quality control practices concerning all components of waste containment.

The ASTM document is entitled *ASTM and other Specifications and Test Methods on the Quality Assurance of Landfill Liner Systems*, and is identified by the following numbers:

Publication Code Number (PCN): 03-435193-38
International Standard Book Number (ISBN): 0-8031-1784-1

It contains 79 ASTM standards and 10 non-ASTM references that are cited in the EPA guidance document, consists of approximately 500 pages, and has a soft cover. The first printing in late 1993 is available at the following prices:

ASTM-member price: \$69.00, non-member price: \$77.00
Quantity discounts of the same publication are available.

ASTM Document Ordering Instructions:

Contact:

ASTM Publications
1916 Race Street
Philadelphia, Pennsylvania, 19103
USA

Telephone: (215) 299-5585
Facsimile: (215) 977-9679

- 1) List each publication by quantity, Publication Code Number (PCN as listed above), title and price.
- 2) Add any additional handling charges to subtotal of order:

| | <u>USA and Canada</u> | <u>All other countries</u> |
|-----------|-----------------------|----------------------------|
| Prepaid | No charge | 10% (\$1.50 minimum) |
| Bill/Ship | 7% (\$1.50 minimum) | 15% (\$1.50 minimum) |
- 3) Residents of Canada, and Pennsylvania and Maryland in the USA, please add applicable sales tax to your order.
- 4) Unless indicated otherwise, all orders will be shipped fourth class.

*Please note: This companion document is offered by ASTM entirely independent of U.S. EPA, hence no credit for its development or responsibility can be assumed for the use of its contents. This page is for information only and does not constitute endorsement.
Prices are subject to change without notice.*

