

FORA ESCA REMEDIATION PROGRAM

Standard Operating Procedure for Mechanical Soil Sifting

Seaside Munitions Response Area

Former Fort Ord
Monterey County, California

April 22, 2008
Amended August 14, 2008

Prepared for:

FORT ORD REUSE AUTHORITY

100 12th Street, Building 2880
Marina, California 93933



Prepared Under:

Environmental Services Cooperative Agreement
No. W9128F-07-2-01621

and

FORA Remediation Services Agreement (3/30/07)

Document Control Number: 09597-07-800-016

Prepared by:

**Standard Operating Procedure
for Mechanical Soil Sifting
Former Fort Ord
Monterey County, California**



Reviewed and Approved By: Stan Cook
ESCA Program Manager
Fort Ord Reuse Authority
Date: 8/29/08



Prepared By: Linda Temple
Remediation Project Manager
Weston Solutions, Inc.
Date: 8/29/08



Approved By: Dwight Gemar, P.E.
Program Manager
Weston Solutions, Inc.
Date: 8/29/08



Reviewed By: Christopher G. Spill, P.G.
Technical Project Manager
LFR Inc.
Date: 8/29/08



Approved By: Kristie Reimer
ESCA Remediation Program Manager
LFR Inc.
Date: 8/29/08

CONTENTS

ACRONYMS AND ABBREVIATIONS..... III

1.0 PURPOSE 1

2.0 SCOPE 1

3.0 REGULATORY REFERENCES..... 1

4.0 RESPONSIBILITIES..... 1

 4.1 Program Manager 1

 4.2 Senior UXO Supervisor..... 1

 4.3 UXO Safety Officer..... 1

 4.4 UXO Quality Control Specialist..... 2

 4.5 UXO Technician..... 2

 4.6 Equipment Operator 2

5.0 OPERATIONS 2

6.0 EQUIPMENT 4

7.0 SAFETY 4

8.0 PERSONNEL PROTECTIVE EQUIPMENT 5

9.0 QUALITY CONTROL AND QUALITY ASSURANCE ACTIVITIES..... 5

 9.1 Material Types 1A, 1B, 2, 3, and 4 6

 9.2 Material Types 5 and 6..... 6

 9.3 Sifting Operations Seeded Items 7

 9.4 Sifting Operations Quality Assurance..... 8

10.0 DATA COLLECTION AND REPORTING..... 8

11.0 DUST MONITORING PLAN 8

12.0 DISPOSITION OF MATERIAL..... 9

13.0 SUMMARY9

APPENDICES

- A Map Showing Location of Sifting Operation
- B Equipment Specifications and Flowsheet
- C Activity Hazard Analysis and Daily Equipment Safety Checklist
- D Daily Quality Control Inspection Report
- E Form 1348-1A, July 91 (EG)

ACRONYMS AND ABBREVIATIONS

Army	United States Department of the Army
BRAC	Base Realignment and Closure
ESCA RP	Environmental Services Cooperative Agreement Remediation Program
ESS	Explosive Safety Submission
FORA	Fort Ord Reuse Authority
LDSP	Land Disposal Site Plan
MD	munitions debris
MEC	munitions and explosives of concern
MRA	Munitions Response Area
MRS	Munitions Response Site
OSHA	Occupational Safety and Health Administration
PM	Program Manager
PPE	personal protective equipment
QA	quality assurance
QC	quality control
SOP	standard operating procedure
SSWP	Site-Specific Work Plan
SUXOS	Senior Unexploded Ordnance Supervisor
UXO	unexploded ordnance
UXOQCS	Unexploded Ordnance Quality Control Specialist
UXOSO	Unexploded Ordnance Safety Officer

1.0 PURPOSE

The purpose of this standard operating procedure (SOP) is to provide the minimum procedures and safety and health requirements applicable to the conduct of mechanical soil sifting operations in the Seaside Munitions Response Area (MRA).

2.0 SCOPE

Personnel performing sifting operations utilizing mechanical means shall conform to this SOP. This SOP is not a stand-alone document and personnel shall become familiar with associated documents and/or manuals related to this operation and associated field activities. In particular, personnel shall be familiar with the Final Addendum to Final OE-15SEA.1-4 Site-Specific Work Plan, Phase II Seaside Munitions Response Area (MRA) Removal Action, Former Fort Ord, dated January 24, 2008 (“the SSWP Addendum”).

3.0 REGULATORY REFERENCES

- Weston Solutions, Inc. Corporate Safety and Health Program
- Occupational Safety and Health Administration (OSHA) General Industry Standards, 29 CFR 1910
- OSHA Construction Standards, 29 CFR 1926
- United States Army Corps of Engineers Engineering Manual 385-1-1, Safety and Health Requirements Manual

4.0 RESPONSIBILITIES

4.1 Program Manager

The Program Manager (PM) is responsible for ensuring availability of resources to safely and effectively implement this SOP.

4.2 Senior UXO Supervisor

The Senior Unexploded Ordnance Supervisor (SUXOS) is responsible for incorporating this SOP in plans, procedures, and training, and ensuring compliance during field operations.

4.3 UXO Safety Officer

The Unexploded Ordnance Safety Officer (UXOSO) ensures that mechanical sifting operations are conducted in a safe manner, in accordance with the SSWP Addendum, this

SOP, and applicable regulatory guidance (see Sections 2.3.2 and 6.0 of the SSWP Addendum).

4.4 UXO Quality Control Specialist

The Unexploded Ordnance Quality Control Specialist (UXOQCS) ensures that quality control inspections are performed and documented in accordance with the SSWP Addendum and this SOP. Deficiencies will be reported to the PM, SUXOS, and UXOSO. The UXOQCS will verify that appropriate corrective measures are taken and documented. The UXOQCS will personally inspect munitions debris (MD) and non-munitions and explosives of concern (MEC) scrap prior to disposal or recycling, and will sign off on Daily Quality Control (QC) Inspection Reports.

4.5 UXO Technician

The UXO Technician provides MEC support and is familiar with the equipment being utilized. The UXO Technician shall perform tasks to include a visual search/survey of the area(s) of operation and inspection of soil being loaded into the sifter and the spoils and finds resulting from sifting.

4.6 Equipment Operator

The Equipment Operator will be qualified and fully trained on the equipment being utilized and shall operate the equipment as directed. The Equipment Operator shall perform daily inspections and maintenance functions as required by the operator's manual(s) and shall perform other duties as needed or directed.

5.0 OPERATIONS

There will be a minimum of two UXO Technicians (UXO Tech II or equivalent) on site during active sifting operations. The UXO Technicians will conduct an overall visual survey of the area prior to starting operations.

The excavated soil screening process will be as follows:

1. The excavated material will be introduced into the feed hopper/grizzly using an armored loader. Material greater than 6 inches in size will be rejected and discharged to one side of the grizzly. This is the first of the six material types generated. This 6-inch reject material will be introduced back into the screening plant a minimum of one more time to minimize the volume of the oversize material. This is the first of the six material types generated. Rock, asphalt, or concrete that is compatible with size reduction using a rock crusher (Material Type 1A) will be processed for size reduction and possible reuse as road base or similar beneficial reuse. Oversized material that is not compatible with the size reduction equipment, such as very large items, lumber, rubber, wire, etc.(Material

Type 1B), will be sorted and transported to a separate staging area and will be 100% inspected by trained UXO personnel as described in Section 9.1. Materials removed by the sifting plant and sorting process (MEC, MD, and non-MEC-related) will be segregated and managed accordingly.

2. The material passing the 6-inch grizzly is less than 6 inches and falls into the feed hopper and onto a heavy duty conveyor belt, which leads to the first magnet. The magnet collects ferrous metal items and discharges the metal from a small conveyor rotating around the magnet into a scrap bin container. This is the second of the six material types generated. Depending on the quantity of metal collected, the bin will be inspected and transported at least daily to the staging area for sorting and will be 100% inspected by trained UXO personnel as described in Section 9.1. Materials (MEC, MD, and non-MEC-related scrap) will be segregated and managed accordingly.
3. The remaining material that is not collected by the magnet continues on a heavy duty conveyor belt, which conveys the material through dual-layered 2-inch (top) and 3/8-inch (bottom) vibrating screens. The upper 2-inch screen is sized to reject larger potential MEC items while minimizing the potential for pluggage by vegetative matter removed during the clearing/grubbing activity. Material greater than 3/8 inch and 2 inches will be rejected and discharged together to one side of the sifting plant onto a stockpile at the end of the conveyor. This material (similar to the 6-inch reject material in #1 above) will be introduced back into the screening plant system at least one more time to minimize the volume of the oversize material. This is the third of the six materials that will be generated. This material will be transported to a separate staging area and will be fed to a rock crusher or similar size reduction equipment. Additional QC inspections will be performed on the size-reduced material as described in Section 9.2.
4. The material that passes through the 3/8-inch conveyor (< 3/8-inch material) is then passed along a heavy duty conveyor belt and passed under a second magnet. The second magnet will collect any ferrous metal and a small conveyor discharges the metal (< 3/8 inch) into a separate scrap bin container. This is the fourth of the six material types generated. This (< 3/8-inch) material will be transported to the sorting area and will be 100% inspected by trained UXO personnel as described in Section 9.1. Materials (UXO, MEC, MD, and non-MEC-related scrap) will be segregated and managed accordingly.
5. Any material that passes through the 3/8-inch vibrating screen and past the second magnet is considered the final screened material. This material should consist only of material that is less than 3/8 inch in size. This is the fifth material type that is generated. Additional QC will be performed on this material as described in Section 9.2.
6. WESTON will process oversized compatible material from the grizzly (Material Type 1A) along with material rejected by the 3/8-inch and 2-inch screens (Material Type 3) in a rock crusher or similar size reduction equipment. The rock crusher will further reduce the size of the material to 1 inch or smaller (1 inch minus). The 1-inch minus material will be designated as Material Type 6. This process will render safe the material processed by the rock crusher. The UXOQC personnel will conduct an inspection at a minimum of twice per day of the 1-inch minus material to make sure that the size of the material has not increased due to wear of the internal components as described in Section 9.2.

The < 3/8-inch sifted soil will be conveyed onto conical-shaped stockpiles by a radial stacking conveyor. Soil sifted each morning will be segregated from soil sifted each afternoon. After the QC step for the sifted soil described in Section 9.2 has been performed, along with a satisfactory recovery of seed items introduced to the sifting plant during the time when the stockpile was generated, the sifted soil stockpile will be loaded into off-road haul trucks. Sifted soil will be transported and placed within the scraped road alignment along General Jim Moore Boulevard or Eucalyptus Road in areas where additional fill soil is needed for the planned road construction project. In the event that any other location is proposed, the United States Department of the Army (Army), the Fort Ord Reuse Authority (FORA), and the regulatory agency stakeholders will be contacted for consultation prior to any placement of soil outside the roadway alignment.

The 1-inch minus material from the rock crusher will be placed into stockpiles. Material processed each morning will be segregated from material processed each afternoon. After the QC step for the crushed material described in Section 9.2 has been performed, and appropriate documentation has been performed as described in Section 12, the crushed material may be loaded into off-road haul trucks for use as road base or similar beneficial use as approved by FORA.

The sifting operation location in Seaside 1 (MRS-15SEA-1) was approved by the Department of Defense Explosive Safety Board in the Explosive Safety Submission (ESS; also known as the “2nd Addendum to the 3rd Amendment, Revision 2 to the 17 Feb 94 LDSP for BRAC of Fort Ord, California,” January 14, 2008). A map showing the location of the sifting operation is provided in Appendix A. In the event that a MEC item with a greater horizontal range of maximum weight fragment than a 60 mm mortar is encountered, the adequacy of the exclusion zones for essential and nonessential personnel will be reevaluated. These exclusion zones are described in the ESS (“2nd Addendum to the 3rd Amendment, Revision 2 to the 17 Feb 94 LDSP for BRAC of Fort Ord, California,” January 14, 2008).

6.0 EQUIPMENT

Equipment specifications and flowsheet are provided in Appendix B.

7.0 SAFETY

Appropriate precautions will be observed during sifting operations. The precautions listed below are general in nature and applicable equipment and operational publications will be reviewed periodically:

- Tailgate safety briefings will be conducted daily, when the operation changes, or when there is a change of personnel
- Maintain 200 feet from other essential operations
- Maintain 1,127 feet for nonessential personnel

- Use equipment safety features (i.e., seat belts, fire extinguishing equipment)
- Applicable safety precautions in operator's manual will be observed
- Communications will be maintained between personnel involved in the operation
- Maintain site control
- Observe MEC precautions for items encountered
- Ensure personal protective equipment (PPE) is serviceable and properly in use
- Mechanical equipment and vehicles used in sifting operations will be armored with the appropriate thickness of Lexan or Plexiglas as indicated in Technical Paper 16 to protect the equipment operators against any unintentional detonations of MEC items; refer to ESS ("2nd Addendum to the 3rd Amendment, Revision 2 to the 17 Feb 94 LDSP for BRAC of Fort Ord, California," January 14, 2008) for specific thickness of protective armoring
- Water will be used for dust mitigation on a case-by-case basis as deemed necessary by the UXOSO

An activity hazard analysis and equipment safety checklist providing additional details about the tasks, potential hazards, control measures, and PPE requirements is provided in Appendix C.

8.0 PERSONNEL PROTECTIVE EQUIPMENT

Level D PPE will be required during mechanical sifting operations. Clothing will include, but not be limited to:

- Coveralls or work clothing as prescribed
- Work gloves, leather or canvas as appropriate
- Safety glasses
- Hard hats, if necessary (not when investigating MEC items)
- Hearing protection, noise attenuators, or ear plugs when within hazardous decibel range of equipment

9.0 QUALITY CONTROL AND QUALITY ASSURANCE ACTIVITIES

As described above, the process of screening the excavated material will generate a total of six types of materials:

1. Oversize material (over 6 inches) from the feed hopper/grizzly (Type 1A compatible with size reduction equipment, Type 1B not compatible with size reduction equipment)
2. > 3/8-inch and < 6-inch metal debris collected by the first magnet
3. > 3/8-inch and < 6-inch debris items rejected by the 2-inch and 3/8-inch vibrating screens

4. < 3/8-inch metal debris collected by the second magnet
5. < 3/8-inch screened soil free of MEC and debris
6. < 1-inch nonferrous metal debris as size reduced by the rock crusher (1 inch minus)

9.1 Material Types 1A, 1B, 2, 3, and 4

UXO personnel will conduct a visual inspection of Material Types 1B through 4 as indicated on the Daily QC Inspection Report (Appendix D). Inspections of these types of materials will be documented on the report form. The purpose of this inspection is to verify that reject materials are properly sorted, segregated, and secured depending on material type.

At the end of the day (or more frequently as deemed necessary), each type of material will be placed at a staging area. The staging area will be positioned to maintain a minimum 200-foot team separation distance from the sifting plant or any other MEC operations. UXO personnel will then inspect 100% of each material type. MEC, MD, or non-MEC-related debris will be segregated and managed in accordance with the established handling procedures.

As part of the QC process, the UXOQC personnel will conduct an inspection at a minimum of once per day of each of the material types (1B through 4). The purpose of this inspection is to verify that the UXO personnel are properly sorting the material. If an item is determined to be improperly sorted and/or a MEC item is missed, a root cause analysis will be conducted to determine why this occurred and a corrective action will be implemented. Failures and corrective actions will be documented. The UXOQCS will also verify that seeds are added to the soil fed to the sifting plant twice per day, and that all seeds are recovered.

Compatible material from the grizzly (Material Type 1A) and reject material from the 3/8-inch and 2-inch screens (Material Type 3) will be processed through a rock crusher set to a 1-inch final product. This process will render safe this oversized material. The UXOQC personnel will conduct an inspection at a minimum of twice per day of the 1-inch minus material to make sure that the size of the material has not increased due to wear of the hammers.

9.2 Material Types 5 and 6

As indicated above, Material Type 5 (< 3/8-inch material) is the final product and is considered to be free of MEC. As part of the QC process, UXO personnel will also inspect Material Type 5 twice a day – typically at midday (lunchtime) and at the end of the day. The screen plant operation will generally create multiple conical piles generated by the radial conveyor belt throughout the day. At midday, UXO personnel will inspect the screened piles generated that morning. The radial stacking conveyor will be repositioned to keep the afternoon production stockpiles separated from the morning stockpiles. At the end of the day, UXO personnel will inspect the screened piles generated since the midday inspection. The loader operator will take approximately 15 cubic yards (three loader buckets) of the material from each morning and afternoon stockpile and spread it into a thin lift. UXO personnel will inspect the material visually (aided with magnetometers and all-metals detectors) for the

presence of MEC, MD, and non-MEC scrap and/or any metal that is greater than 3/8 inch. If any metal greater than 3/8 inch is found, the entire stockpile will be re-processed through the screen plant. In addition, a root cause analysis will be conducted followed by corrective actions. Failures and corrective actions will be documented. Once the inspection is completed, the QC material will be consolidated back into the same production stockpile from where it was removed.

Material Type 6 consists of debris reduced by the rock crusher to 1 inch or less. This material will receive a similar inspection as Material Type 5 above. Inspections will be conducted a minimum of twice per day, or as needed based on rock crusher operations. The loader operator will take approximately 15 cubic yards (three loader buckets) of the material from each morning and afternoon stockpile and spread it into a thin lift. UXO personnel will inspect the material visually (aided with magnetometers and all-metals detectors) for the presence of MEC, MD, and non-MEC scrap and/or any material that is greater than 1 inch. If any material greater than 1 inch is found, the entire stockpile will be reprocessed through the rock crusher. In addition, a root cause analysis will be conducted followed by corrective actions. Failures and corrective actions will be documented. Once the inspection is completed, the QC material will be segregated for future use. If off-site recycling or disposal is required, Weston will follow the procedures as indicated in Section 12.0 of this SOP.

9.3 Sifting Operations Seeded Items

As part of the QC process, the UXOQCS or designated representative will place three seed items in the sifting plant twice daily (morning and afternoon) during the sifting operations. The seeds consist of the following items:

- 57mm, painted blue
- 1 ½" x 5" galvanized pipe painted orange (used to simulate 37 - 40mm in size)
- ½"x 12" piece of rebar painted blue (used to simulate 22mm and 35mm subcals)

These items will be placed in the bucket of the heavy equipment loading the hopper of the sift plant. For safety reasons, the UXOQCS or designated representative will wait until soil fed to the screen plant has cleared from the machine prior to entering the 200-foot exclusion zone for placement of the seed items.

The purpose of this QC task is to verify that the screening operation can remove detectable items from the excavated material. At the next shutdown of the plant, the UXOQC personnel will inspect the various materials rejected to determine if the seed items were removed by the magnets and/or screens.

If all seeds are not accounted for in the finds, a root cause analysis will be conducted. UXO technicians will inspect the area around the sifting plant to locate the seed item. The necessary adjustments and corrective actions will be conducted. The results of the seed placement test and corrective actions will be documented by the UXOQC personnel.

In addition to the twice-daily placement of seed items and QC checks of the sifted soil, the screens on the sifting plant will also be inspected twice-daily for damage as a means to provide early detection of potential problems as noted on the Daily QC Inspection Report form.

9.4 Sifting Operations Quality Assurance

FORA has contracted with a third-party quality assurance (QA) contractor to provide oversight of MEC-related activities associated with the Seaside MRA Removal Action work, including the soil sifting operations. This QA activity is in addition to, and is independent of, the Environmental Services Cooperative Agreement Remediation Program (ESCA RP) Team's QC activities described above in Sections 9.1 through 9.3. As noted in the Quality Assurance Surveillance Plan for the Seaside MRA Removal Action, the QA personnel will perform periodic inspections and observe for the following performance indicators:

- Equipment serviceable and in good condition (screens)
- Personnel knowledgeable in plant operation
- Dust control (if applicable)

Quantitative surveillance metrics will consist of periodically introducing seed items into the sifting plant and verifying that all seed items are rejected by the sifting plant.

10.0 DATA COLLECTION AND REPORTING

Data collected during sifting operations include: number and types of MEC encountered by Munitions Response Site (MRS), weight of MD recovered by MRS, weight of range-related and cultural debris recovered by MRS, amount of soil processed by MRS, and the final disposal location of various materials processed. Data will be documented in the Group 1 Remedial Investigation/Feasibility Study Report, which includes the Seaside and Parker Flats MRAs.

11.0 DUST MONITORING PLAN

This Dust Monitoring Plan presents the dust minimization, controls, and monitoring requirements that will be implemented during sifting operations. During site operations, personnel will implement dust controls during site operations, which will consist of spraying water along the haul routes, work areas, and stockpiled soil introduced to the screening plant, as needed to minimize fugitive dust. In addition, heavy equipment speeds will be monitored to minimize dust emissions.

In addition, two stationary dust monitoring stations will be set up during working hours. One dust monitor will be set up in the work area to monitor dust levels for worker safety purposes as indicated in the Activity Hazard Analysis in Appendix C. The second monitor will be set

up near the perimeter of the work area to monitor dust levels leaving the site. The dust monitors will continuously monitor the dust concentrations and record the dust concentrations every minute. The data will be downloaded at the end of each day and maintained in the project files for documentation purposes. In addition, personnel will periodically inspect the dust monitors to determine if dust control measures need to be increased and/or site operations need to be modified. Site management will also visually monitor the site for “visible” dust and make any necessary corrective actions. The Monterey Bay Unified Air Pollution Control District 24-hour ambient air quality standard is 50 micrograms per cubic meter ($\mu\text{g}/\text{m}^3$; <http://www.mbuapcd.org/index.cfm?Doc=383>). Every effort will be made to ensure the site activities and dust controls are implemented such that the dust emissions are minimized and the ambient air quality standard is achieved.

12.0 DISPOSITION OF MATERIAL

After completing processing and QC inspections, the 1-inch minus material, which has been processed through the rock crusher, may be used for road base aggregate. All MD and non-MEC related material leaving the Seaside MRA site will require two UXO signatures documenting that the material is free of MEC and UXO using DD Form 1348-1A, July 91 (EG), which is included in Appendix E. The signatures will certify and verify the following statement:

“This certifies and verifies that the material presented herein has been 100% inspected and to the best of our knowledge and belief, are inert and/or free of explosives or related materials.”

13.0 SUMMARY

This SOP will be used to ensure that the requirements for mechanical sifting operations are conducted in a safe, efficient, and productive manner. The UXOSO and PM will make changes to this SOP as safety and operational necessity dictate. Changes to the SOP will be documented using a field variance form and routed to the Army, FORA, and regulatory agency stakeholders for concurrence.



APPENDIX A

Map Showing Location of Sifting Operation

K:\001_EMV\03608595_FORD\GIS\ArcGIS\Projects\ESRA_Figures\Week062907\Seaside Exclusion Zone Maps for ESS Report\ESS_newJan 3 08\ExplosivesHazardSafetyZones_Seat_Siftmxd.mxd - 1/14/2008 @ 1:35:34 PM



Legend

-  MRS Boundary
-  Horizontal Range of Maximum Weight Fragment (MFR-H)
-  Sifting Plant

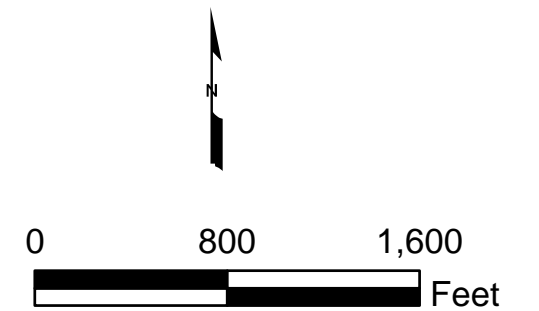

Seaside 1 (MRS-15SEA.1)
Minimum Separation Distance
Land Disposal Site Plan
(2nd Addendum to 3rd Amendment)

FORA ESCA RP
Monterey County, California

Figure 1

APPENDIX B

Equipment Specifications and Flowsheet

GENERAL SCREENING SYSTEM REQUIREMENTS

The system should operate as shown on the included figure to allow all oversized material to be processed through the screening plant. The system should be capable of screening a minimum of 250 cubic yards per hour of predominantly sandy soil through a 2-inch and 3/8-inch screen vibratory screen deck.

The following components will comprise the screening system:

- Item #1 – Feed Hopper with Grizzly - Receiving hopper for front end loader with either a self-cleaning sloping grizzly or a vibrating grizzly. Grizzly will have a nominal 6-inch spacing to remove oversize material; 12 ton minimum storage capacity, wide feed opening with heavy duty 36-inch wide roller belt feeder with electric/hydraulic variable speed drive, discharge gate to control material flow, full length skirtboards, and belt scraper.
- Item #2 - Transfer Conveyor - 36-inch wide by 20-foot long (one each) transfer conveyor with heavy duty belt complete with electric motor, v-belt drive with OSHA drive guard, shaft mount reducer with internal backstop, receiving hopper with skirtboards and bolt-on wing extensions, conveyor belting with rubber covers, and support legs.
- Item #3 - Screening Plant - Portable screening plant with a double deck vibrating screen (2-inch top, 3/8-inch bottom screens), electric motor drive, common oversize discharge chute, collecting hopper under screen, 30-inch wide discharge conveyor with heavy duty belt, for material passing through the screen, all mounted on tracks.
- Item #4 - Radial Stockpiling Conveyor - 30-inch wide by 60-foot long radial stockpiling conveyor complete with electric motor, v-belt drive with OSHA drive guard, shaft mount reducer with internal backstop, receiving hopper with skirtboards and bolt-on wing extensions, undercarriage with manual raise/lower feature, pivot plate assembly, and wheels that pivot for radial travel.
- Item #5 - Magnetic Separators (two required) - 36-inch wide self-cleaning magnetic separator assembly complete with heavy duty clad belting and electric motor drive. Magnetic intensity of each assembly should be a minimum of 760 Gauss at 20 inches. Vendor shall install magnets as part of equipment set-up.

CONVEYOR SAFETY REQUIREMENTS

Conveyor systems shall comply with all applicable safety requirements specified in California Title 8 Section 3999 and 29 CFR 1926.555. In addition, the following requirements specified in U.S. Army Corps of Engineers Safety and Health Requirements Manual (EM 385-1-1) also apply:

1. Where reversing or runaway are potential hazards or the effects of gravity create a potential for hazardous uncontrolled lowering, anti-runaway devices, brakes,

- backstops, or other safeguards shall be installed to protect persons from injury and property from damage.
2. Conveyor systems shall be equipped with an audible warning signal to be sounded immediately before starting of the conveyor.
 3. All conveyors shall be equipped with emergency stopping devices along their full length. Emergency stop devices shall be easily identifiable and readily accessible and shall act directly on the control of the conveyor of concern and not depend on the stopping of any other equipment. Emergency stop devices shall be installed so that they cannot be overridden from other locations.
 4. Safety devices shall be arranged to operate in such a manner that if power failure or a failure of the device occurs, a hazardous condition would not result.
 5. All exposed moving machinery parts that present a hazard shall be mechanically or electrically guarded or guarded by location.
 6. Nip and shear points shall be guarded.
 7. At all points along the conveyor, except at points where loads are removed from or placed on a conveyor or where a conveyor discharges to or receives material from another conveyor, provisions shall be made to eliminate the possibility of loads or material being dislodged from the conveyor.
 8. Unless the design, construction, and operation of a conveyor is clearly non-hazardous to personnel, emergency stop buttons, pull cords, limit switches, or similar emergency devices shall be provided at the following locations for remotely or automatically controlled conveyors or conveyors where operator stations are not manned or are beyond voice and visual contact from drive areas: (1) loading arms, (2) transfer points, and (3) other potentially hazardous locations on the conveyor path not guarded by location or guards.
 9. When counterweights are supported by belts, cables, chains, or similar means, the weights shall be confined in an enclosure to prevent the presence of personnel beneath the counterweight, or the arrangement shall provide a means to restrain the falling weight in case of failure of the normal counterweight support.
 10. When two or more conveying systems are interfaced, special attention shall be given to the interfaced area to ensure the presence of adequate guarding and safety devices.
 11. Conveyor controls shall be arranged so that in case of an emergency stop, manual reset or restart is required at the location where the emergency stop was initiated to resume conveyor operations.
 12. Control stations shall be arranged and located so that the operation of the equipment is visible from them.
 13. Controls shall be clearly marked or labeled to indicate the function controlled.
 14. All openings to the hopper and chutes shall be guarded to prevent persons from accidentally stepping into them. If guards are not practical, warning signs shall be posted.

15. Mobile conveyors shall be provided with brakes or other position locking devices for each degree of motion where movement would present a hazard.
16. Mobile conveyors shall be designed to be stationary against runaway and stable against overturning under normal conditions of operation.
17. The raising and lowering mechanism for the boom of a portable conveyor shall be provided with a safety device that will hold the boom at any rated angle of inclination.
18. Portable conveyors shall be stable so that the conveyor will not topple when used with the manufacturer's rating and in a manner in which it was intended or when being moved.

Screening System Arrangement

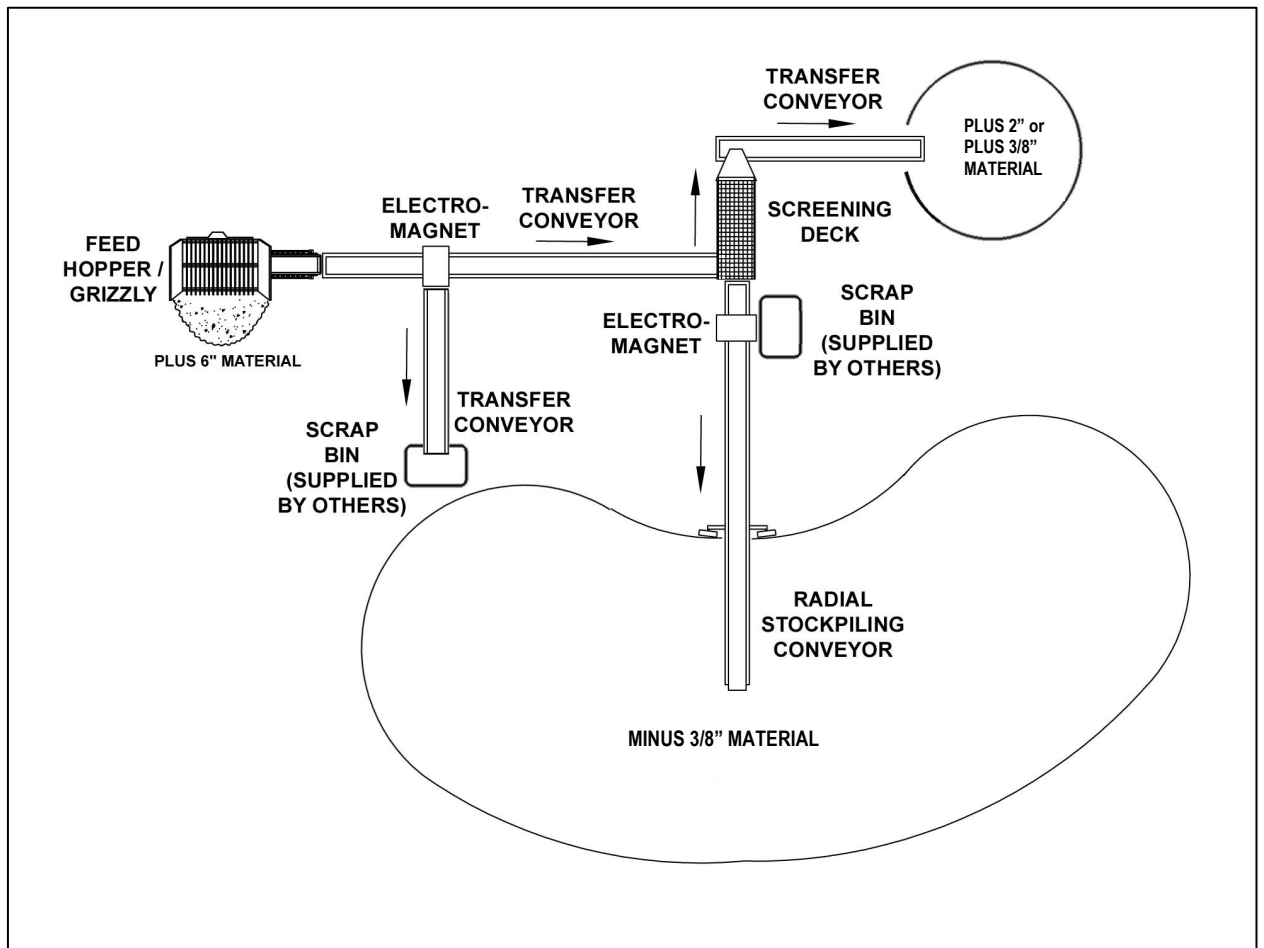

GENERAL ROCK CRUSHER SYSTEM REQUIREMENTS

The system should operate to process oversized material (material rejected from Grizzly (6-inch [in.]), 2-in. and 3/8-in. screens into material that is less than 1-in. (1-in. minus). The system should be capable of processing a minimum of 250 tons per hour of predominantly rock and asphalt through the impact hammers set to 1-in.

The following components will comprise the screening system:

- Item #1 – Feed Hopper with Grizzly - Receiving hopper for front end loader with a vibrating grizzly. Grizzly will have 2-inch finger spacing and is adjustable to accept up to 16-in. material; 5 cubic yard hopper, wide feed opening with heavy duty 39-inch wide roller belt feeder with a hydraulic fixed speed drive, discharge gate to control material flow, full length skirtboards, and belt scraper.
- Item #2 - Transfer Conveyor - 20-inch wide by 20-foot long (2 each) transfer conveyor with heavy duty belt complete with hydraulic motor and receiving hopper with skirtboards and bolt-on wing extensions, conveyor belting with rubber covers, and support legs.
- Item #3 - Impact Crusher Plant - Portable crushing plant with a 42-inch rotor, wedge belt drive, common oversize discharge chute, collecting hopper under screen, blow bars, impact apron, 24-inch wide discharge conveyor with heavy duty belt, for material passing through the impactor, all mounted on tracks.
- Item #4 – Sizing Screen – 5-foot wide sizing screen with a hydraulic drive vibrator. 1-in. screen size will be installed.
- Item #5 - Fines Stockpiling Conveyor - 55-inch wide 80 foot long fines stockpiling conveyor complete with hydraulic motor.
- Item #6 - Magnetic Separator- 30-inch wide self-cleaning magnetic separator assembly complete with heavy duty clad belting and hydraulic motor drive. Magnetic intensity of each assembly should be a minimum of 570 Gauss at 8 inches.

CONVEYOR SAFETY REQUIREMENTS

Conveyor systems shall comply with all applicable safety requirements specified in California Title 8 Section 3999 and 29 CFR 1926.555. In addition, the following requirements specified in U.S. Army Corps of Engineers Safety and Health Requirements Manual (EM 385-1-1) also apply:

1. Where reversing or runaway are potential hazards, or the effects of gravity create a potential for hazardous uncontrolled lowering, anti-runaway devices, brakes, backstops, or other safeguards shall be installed to protect persons from injury and property from damage.

2. Conveyor systems shall be equipped with an audible warning signal to be sounded immediately before starting of the conveyor.
3. All conveyors shall be equipped with emergency stopping devices along their full length. Emergency stop devices shall be easily identifiable and readily accessible and shall act directly on the control of the conveyor of concern and not depend on the stopping of any other equipment. Emergency stop devices shall be installed so that they cannot be overridden from other locations.
4. Safety devices shall be arranged to operate in such a manner that if power failure or a failure of the device occurs, a hazardous condition would not result.
5. All exposed moving machinery parts that present a hazard shall be mechanically or electrically guarded or guarded by location.
6. Nip and shear points shall be guarded.
7. At all points along the conveyor, except at points where loads are removed from or placed on a conveyor or where a conveyor discharges to or receives material from another conveyor, provisions shall be made to eliminate the possibility of loads or material being dislodged from the conveyor.
8. Unless the design, construction, and operation of a conveyor is clearly non-hazardous to personnel, emergency stop buttons, pull cords, limit switches, or similar emergency devices shall be provided at the following locations for remotely or automatically controlled conveyors or conveyors where operator stations are not manned or are beyond voice and visual contact from drive areas: (1) loading arms, (2) transfer points, and (3) other potentially hazardous locations on the conveyor path not guarded by location or guards.
9. When counterweights are supported by belts, cables, chains, or similar means, the weights shall be confined in an enclosure to prevent the presence of personnel beneath the counterweight, or the arrangement shall provide a means to restrain the falling weight in case of failure of the normal counterweight support.
10. When two or more conveying systems are interfaced, special attention shall be given to the interfaced area to ensure the presence of adequate guarding and safety devices.
11. Conveyor controls shall be arranged so that in case of an emergency stop, manual reset or restart is required at the location where the emergency stop was initiated to resume conveyor operations.
12. Control stations shall be arranged and located so that the operation of the equipment is visible from them.
13. Controls shall be clearly marked or labeled to indicate the function controlled.
14. All openings to the hopper and chutes shall be guarded to prevent persons from accidentally stepping into them. If guards are not practical, warning signs shall be posted.
15. Mobile conveyors shall be provided with brakes or other position locking devices for each degree of motion where movement would present a hazard.

16. Mobile conveyors shall be designed to be stationary against runaway and stable against overturning under normal conditions of operation.
17. The raising and lowering mechanism for the boom of a portable conveyor shall be provided with a safety device that will hold the boom at any rated angle of inclination.
18. Portable conveyors shall be stable so that the conveyor will not topple when used with the manufacturer's rating and in a manner in which it was intended or when being moved.

Photograph of Rock Crusher



Manufacturer's specification sheets for the rock crusher are found below.

TEREX PEGSON

4242SR SPECIFICATION

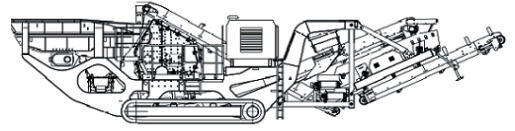

IMPACT CRUSHER

Crusher type: 428 Fixed Hammer Impactor.
Feed opening: 42" x 28".
Rotor Width: 42"
Rotor Diameter: 42" (Over Hammers).
Crusher frame: Fabricated from steel plate and lined with replaceable liner plates.
Rotor: Runs in two heavy-duty spherical self aligning roller bearings and is fitted with four reversible and replaceable fixed blow bars.
Blowbars: Two full size and two half size standard manganese blow bars are fitted as standard.
Impact aprons: Fitted in upper and middle positions and lined with wear resistant impact plates.
Drive: Through wedge belts with screw tension adjustment on engine.
Engine pulley: Machines built for stock are fitted with the fast speed pulley (suitable for quarry applications). The slower crusher pulley is supplied loose.
Maximum feed size: 16" depending on type of blow bar and material being processed.
Impactor speeds: Slow 506 rpm (8-7/8" diameter)
Fast 630 rpm (11" diameter)
Lubrication: Greased roller bearings, inner and outer labyrinth seals.

Adjustment: Manual adjustment on upper and lower aprons with overload compression springs on lower apron.
Maintenance: Hydraulic case opening
Crusher Liners: Fully lined internally with abrasion resistant steel.
Grinding path: Optional grinding path with manual adjustment and overload compression springs suitable for certain quarry applications.

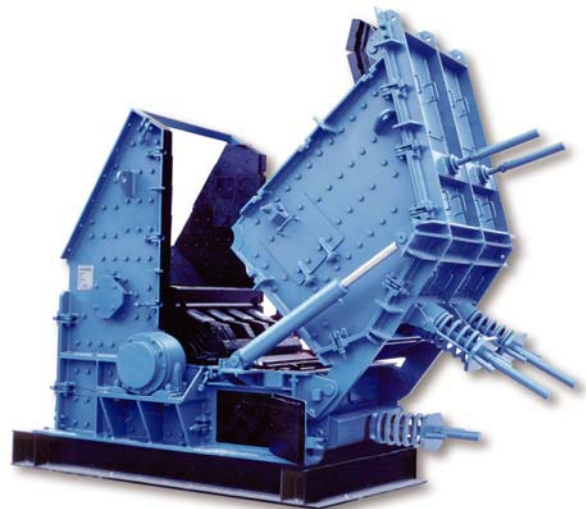

APPLICATIONS

This plant is designed for both demolition and quarrying applications, however it is vitally important that large pieces of steel or similar uncrushable objects are not allowed to enter the crushing chamber as severe damage and injury may occur. When fitted with manganese blow bars the crusher will tolerate small quantities of steel reinforcing bar in the feed. However, the machine is not designed to accept large pieces of steel or other uncrushable objects such as bucket teeth.

4242SR SPECIFICATION

IMPACT CRUSHER - INTERNAL

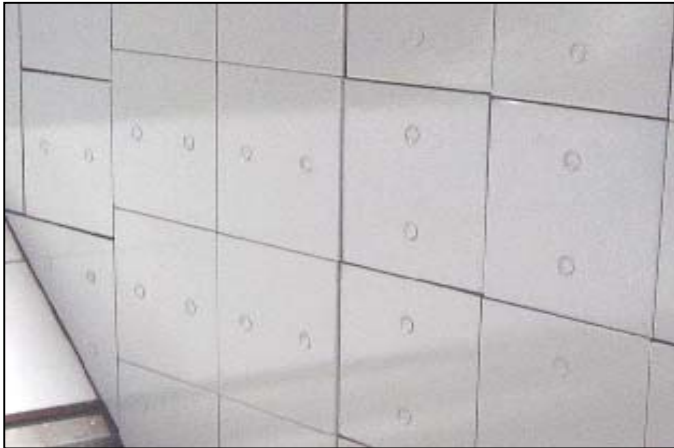
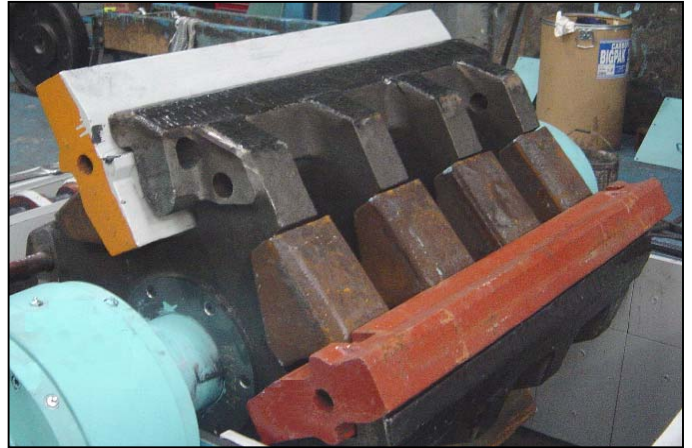
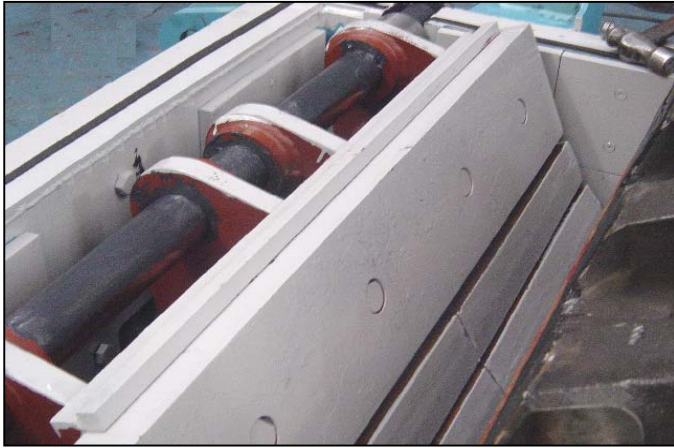

HOPPER

Hopper type:	Fixed Hopper.
Hopper length:	13'2"
Hopper width:	6'11"
Hopper capacity:	Up to 5yd ³ gross depending on method of feed.
Hopper body:	Hardox wear resistant steel plate with suitably braced steel sections.



VIBRATING GRIZZLY FEEDER

Type:	Spring mounted vibrating pan.
Vibrating unit:	Twin heavy-duty cast eccentric shafts running in spherical roller bearings, gear coupled at drive end.
Length:	12'6".
Width:	42".
Drive:	Flange mounted hydraulic motor
Grizzly:	7'0" long double section of welded tapered finger bars at 2" spaces fabricated in 3/4" thick abrasion resistant steel.
Underscreen:	Removable rubber blanking mat fitted as standard. This can be substituted for various aperture wire meshes.
Control:	Variable speed control through a proportional flow control valve.

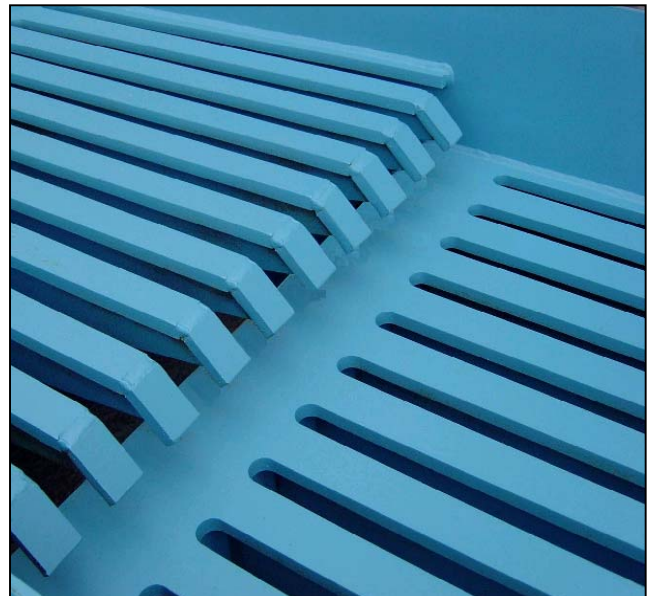

4242SR SPECIFICATION

ON PLANT PRODUCT CONVEYOR

Conveyor type: Troughed belt conveyor with fixed tail end.
Belt type: Ripstop EP500/3 with 3/8" top and 1/8" bottom heavy-duty rubber covers.
Belt width: 39"
Drive: Direct drive hydraulic motor
Feedboot: Fabricated in mild steel plate with abrasion resistant steel liners.
Skirting: Fully skirted wear resistant rubber sealing along the conveyor length.

Belt covers: Canvas type removable dust covers are fitted at the head end beyond the magnet area.
Impact cradle: This is provided beneath the belt immediately below the impactor outlet.
Lubrication: Grease nipples located on bearing housings at tailshaft.
Control: Fixed speed.

FINES PRODUCT CONVEYOR

Conveyor type: Plain troughed belt
Belt type: EP400/2 with 3/16" top and 1/16" bottom rubber covers. A vulcanised joint is included.
Position: Mounted beneath the sizing screen.
Width: 55"
Discharge Height: 9'8"
Drive: Direct drive hydraulic motor.
Lubrication: Grease nipples located on bearing housing at head and tailshaft.
Control: Fixed Speed.



TOP DECK SIDE TRANSFER CONVEYOR (Fitted as standard)

Conveyor type: Plain belt.
Belt type: EP400/2 with 3/16" top and 1/16" bottom rubber covers. A vulcanised joint is included.
Conveyor: Transfers material from the top deck of the sizing screen to the re-circulating conveyor.
Width: 20"
Drive: Direct drive hydraulic motor.
Lubrication: Grease nipples located on bearing housing at head and tailshaft.

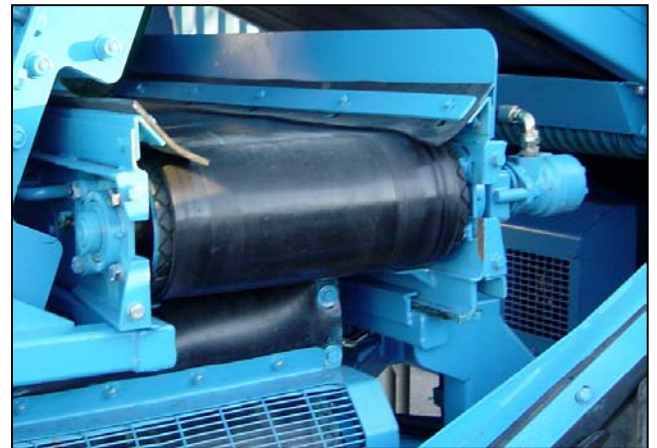

BOTTOM DECK SIDE TRANSFER CONVEYOR (Optional extra)

Conveyor type: Plain belt.
Belt type: EP400/2 with 3/16" top and 1/16" bottom rubber covers. A vulcanised joint is included.
Conveyor: Transfers material from the bottom deck of the sizing screen to the optional plant mounted stockpiling conveyor or the re-circulating conveyor when in position.
Width: 20".
Drive: Direct drive hydraulic motor.
Lubrication: Grease nipples located on bearing housing at head and tailshaft.



4242SR SPECIFICATION

ON PLANT DIRT/SIDE CONVEYOR

Conveyor type: Plain troughed belt, hydraulic folding for transport.
Width: 24".
Discharge height: 6'6"
Drive: Direct drive hydraulic motor.
Lubrication: Grease nipples located on bearing housing at head and tailshaft.
Skirts: Full length.
Position: Mounted to discharge on near side of plant.



SIZING SCREEN

Type: Double deck vibrating screen (Four bearing type)
Size: 11'0" x 5'0".
Position: Mounted beneath the impactor product conveyor.
Drive: Hydraulic drive.
Top deck: 1'8" aperture fitted as standard
Bottom deck: Optional mesh.
Control: Fixed speed. (1100 rpm)
Lubrication: Four grease nipples.



RE-CIRCULATING CONVEYOR

(Fitted as standard)

Conveyor type: Chevron type troughed belt.
Belt type: EP315/2 with 1/8" top and 1/32" bottom rubber covers, 1-3/8" high cleats and a vulcanised joint.
Conveyor: Returns oversize material transferred from the top deck back to the impactor for re-crushing. This conveyor can be slewed to enable oversize material to be stockpiled at the side of the plant.
Width: 20".
Drive: Direct drive hydraulic motor
Lubrication: Grease nipples located on bearing housing for tailshaft. Remote grease nipples for head drum.
Control: Fixed speed.



STOCKPILING CONVEYOR

(Optional extra)

Conveyor type: Chevron type troughed belt
Belt type: EP315/2 with 1/8" top and 1/32" bottom rubber covers, 1-3/8" high cleats and a vulcanised joint.
Width: 20".
Drive: Direct drive hydraulic motor.

Lubrication: Grease nipples located on bearing housing at tailshaft. Remote grease nipples for head drum.
Conveyor: Stockpiles material transferred from the bottom deck side transfer conveyor to the side of the plant.

4242SR SPECIFICATION

BELT SCRAPERS

Type: Torsion type belt scrapers with polyurethane blades fitted as standard (Except on chevron belt).



PLANT CHUTEWORK

Impactor feed chute: Fabricated in 3/8" mild steel plate with full width single strand chain curtain and rubber curtain. Liners are fitted at wear points.

Grizzly fines chute: Chutework fabricated in 1/4" mild steel plate is provided with two-way flapdoor. Material passing over the blanking mat is discharged to the main product conveyor via the bypass chute. Material passing through the underscreen (when fitted) is discharged to the side dirt conveyor and the flap door will allow a portion of the material to be diverted to the main product conveyor.



POWERPACK

Powerpack type: Caterpillar C-9.
Performance: 309 HP (230kW) at 1800 rpm at sea level.
Engine: Six cylinders, four stroke, direct Injection.

CLUTCH

Clutch type: Manually operated twin disc clutch.



MAGNET

Magnet Type: Suspended self-cleaning overband, fitted with endless belt.
Magnet Width: 30".
Magnet length: 39".
Drive: Hydraulic Motor.
Control: Pre-set variable speed.
Discharge chute: Via stainless steel shedder plate.
Power: 570 Gauss at 8".
450 Gauss at 10".



4242SR SPECIFICATION

CRAWLER TRACKS

Type:	Heavy-duty tracks fitted as standard.
Pitch:	6-6/10"
Longitudinal centres:	12'2".
Track width:	1'4".
Climbing grade:	29° maximum.
High speed:	0.5 mph.
Slow speed:	0.2 mph.
Drive:	Hydraulic integral motors
Control:	Remote handset - Dual Speed
Track tensioning:	Hydraulic adjuster, grease tension.



DUST SUPPRESSION SPRAYS

Sprays bars with atomiser nozzles are mounted over the impactor discharge point and the fines product conveyor head piped to an inlet manifold for client's pressured water supply.

Type:	Clean water multi atomising nozzles.
Inlet:	Single Point.
Pressure required:	2.8 bar (42 psi).
Water supply:	1.85 gallons per minute.
Frost protection:	Via system drain valves.
Pump:	Optional extra.



GUARDS

Wire mesh or sheet metal guards are provided for all drives, flywheels, pulleys & couplings.

The guards provided are designed and manufactured to ensure as far as reasonably practicable that the machinery and plant on which they are fitted can be operated safely and without risk to health when properly used. However, the company cannot guarantee that they will meet requirements of any individual inspectors or local laws.



PLATFORMS

A steel grid maintenance platform is provided on one side of the feeder and impactor fitted with double row handrails and access ladders. Platforms are also included to gain access to the rear of the crusher and the powerpack.



4242SR SPECIFICATION

TOOLBOX

A plant mounted lockable toolbox is provided containing the slower speed pulley, operators manual, impactor stops, spanner, door open locking pins, screen mesh tensioning hoses, blow bar ejector hoses and a grease gun.



CHASSIS

Heavy duty steel fabricated I section of welded construction.



PLC CONTROLS

A PLC control system is fitted onto the plant to operate the following items: -

- Feeder (Start/Stop/Speed).
- Dirt Conveyor (Start/Stop).
(Also operates Re-Circulating and stockpiling conveyors)
- Product Conveyor (Start/Stop).
- Screen (Raise/Lower).
- Re-Circulating Conveyor (Raise/Lower).
- Dirt Conveyor (Raise/Lower).
- Screen (Start/Stop).



PLANT CONTROLS

Controls are fitted onto the plant to operate the following items: -

- Feeder (Start/Stop/Speed).
- Dirt Conveyor (Start/Stop).
- Product Conveyor (Start/Stop).
- Screen (Raise/Lower).
- Conveyor (Raise/Lower).



4242SR SPECIFICATION

REMOTE CONTROL

A remote radio control is provided for the tracking function, this also provides stop and start controls for the vibrating grizzly feeder, together with a plant stop button for the plant. This facility is only available in certain countries where type approval has been obtained. For a full list of countries please consult with BLP or your dealer.



UMBILICAL CONTROL

An umbilical control unit is also supplied with the plant. This has the same features as the remote control.



OPTIONAL EXTRAS

(For prices refer to BL-Pegson Limited)

- Hydraulic driven water pump assembly to provide a pressurised water supply to the dust suppression sprays.
- Re-fuelling pump kit.
- High Chrome hammers.
- High Manganese hammers.
- Single idler belt weigher with integrator and speed sensing wheel fitted to main product conveyor.
- 20" wide plant reversible bottom deck oversize side transfer conveyor.
- 20" wide stockpiling conveyor from the bottom oversize transfer conveyor.
- Wire meshes for feeder underscreen to separate scalplings at 3/8", 3/4", 1-3/16", 1-9/16" and 2".
- Grinding path (not suitable for demolition applications) fitted in the lower position and lined with wear resistant impact plates on the upper section, and reversible manganese impact bars on the lower section. The grinding path assembly is an optional part of the machine and is omitted from the standard build. When fitted greater control on the product size is achieved together with improved product shape.
- Kit of parts required to replace grinding path consisting of liner plates, crash box, bolts etc. (Note this is standard on plants supplied without grinding path).
- Four full size hammers in lieu of two full and two half hammers.

4242SR SPECIFICATION

PLANT DIAGRAM

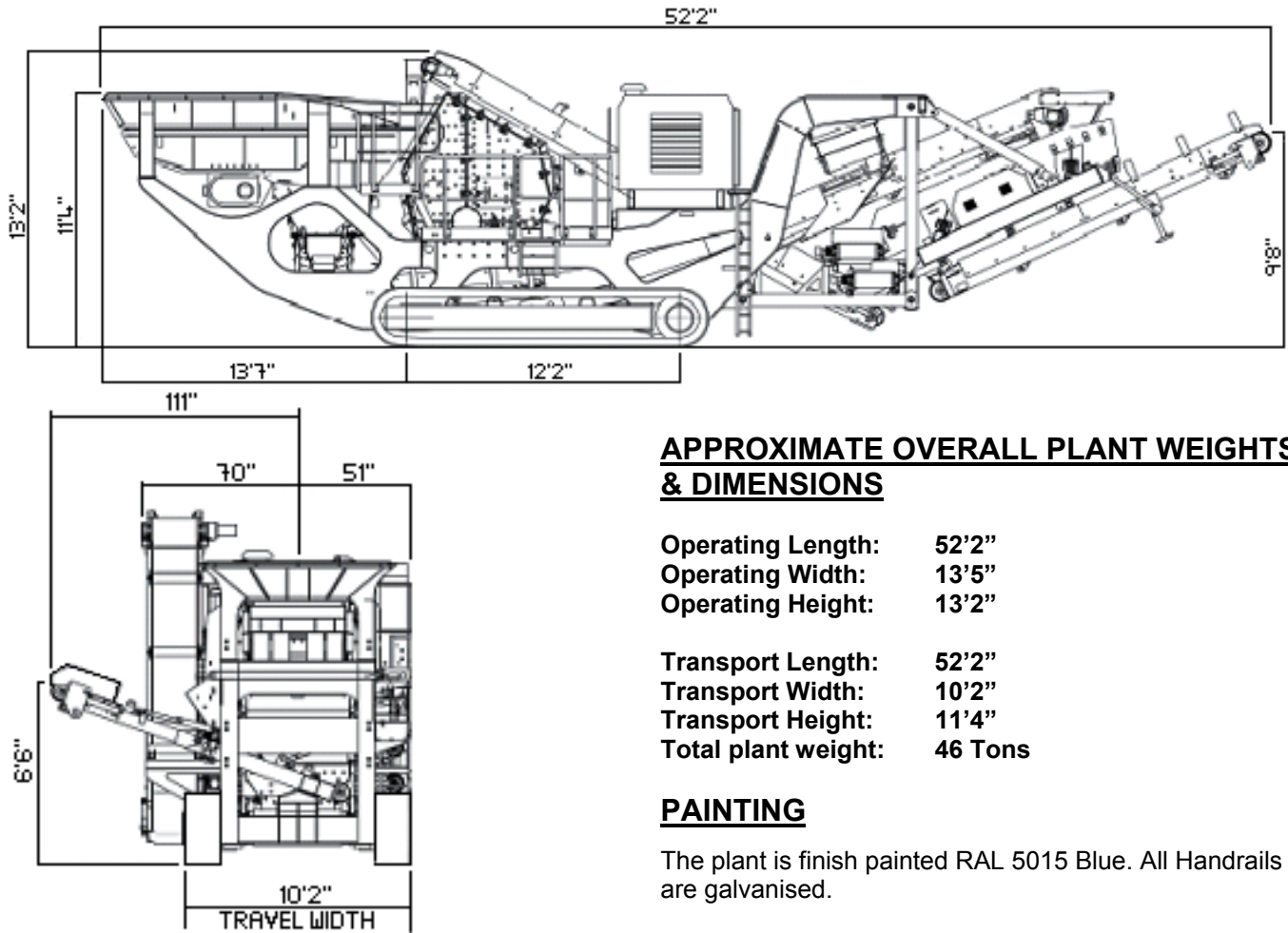

APPROXIMATE OVERALL PLANT WEIGHTS & DIMENSIONS

Operating Length: 52'2"
Operating Width: 13'5"
Operating Height: 13'2"

Transport Length: 52'2"
Transport Width: 10'2"
Transport Height: 11'4"
Total plant weight: 46 Tons

PAINING

The plant is finish painted RAL 5015 Blue. All Handrails are galvanised.

We cannot guarantee that the equipment quoted will meet any specific requirement in respect of noise or vibration levels, dust emissions, or any other factors relevant to health and safety measures or environmental protection needs. However, on receipt of specific requests we will endeavour to ascertain the need for additional equipment and, if appropriate, quote extra to contract prices.

Every endeavour will be made to supply equipment as specified, but we reserve the right, where necessary, to amend specifications without prior notice as we operate a policy of continual product development. It is the importers responsibility to check that all equipment supplied complies with local legislation.

APPENDIX C

Activity Hazard Analysis and Daily Equipment Safety Checklist

ACTIVITY HAZARD ANALYSIS

Activity: Soil Screening Operations

Analyzed By: Greg Clark

Reviewed By: Bruce Moe

Seaside MRS, Former Fort Ord

Activity Hazard Analysis – Soil Screening			
<i>Task</i>	<i>Potential Hazard(s)</i>	<i>Control Measure(s)</i>	<i>Personal Protective Clothing</i>
1) Heavy Equipment Operations	a) Slips, trips, or falls on walking and working surfaces	<ul style="list-style-type: none"> • Maintain clean work areas by following good housekeeping procedures. • Be alert for uneven terrain and steep slopes. • Wear slip-resistant footwear when walking/working on slippery surfaces. • Fall protection will be used whenever performing maintenance or fueling where employees are subject to a 6-foot or greater fall hazard. 	Heavy Equipment Operators/Laborers – hard hat, safety glasses with side shields or goggles, steel-toe safety boots, reflective vests, ear protection, and leather/rubber/cotton gloves, as necessary.
	b) Fire/HazMat spills	<ul style="list-style-type: none"> • Any spills or leaks of petroleum products shall be reported to the Unexploded Ordnance Safety Officer (UXOSO) and Site Manager. • Spill and absorbent materials will be readily available. • Spilled HazMat will immediately be cleaned up and containerized. • All heavy equipment will be equipped with an ABC-type fire extinguisher that will be inspected daily and documented. 	

ACTIVITY HAZARD ANALYSIS

Activity: Soil Screening Operations

Analyzed By: Greg Clark

Reviewed By: Bruce Moe

Seaside MRS, Former Fort Ord

Activity Hazard Analysis – Soil Screening			
<i>Task</i>	<i>Potential Hazard(s)</i>	<i>Control Measure(s)</i>	<i>Personal Protective Clothing</i>
1) Heavy Equipment Operations (continued)	c) Temperature extremes	<ul style="list-style-type: none"> • Heat Stress Monitoring Program will go into effect at 90° F or as directed by the UXOSO. • Heavy equipment with enclosed cab will be equipped with air conditioning and heaters. • Crews will take heat stress breaks as necessary. • Equipment will be maintained according to manufacturer's recommendations. 	Heavy Equipment Operators/Laborers – hard hat, safety glasses with side shields or goggles, steel-toe safety boots, reflective vests, ear protection, and leather/rubber/cotton gloves, as necessary.
	d) Dust	<ul style="list-style-type: none"> • Safety technicians will monitor airborne dust levels in the work area. Airborne dust shall be suppressed by application of a water-based mist, as necessary, to keep levels below action level of 2.5 milligrams per cubic meter (mg/m³). If particulate levels are at or above the action levels, additional wet methods will be used to reduce the dust levels. "No Visible Emissions Rule will be in effect." 	

ACTIVITY HAZARD ANALYSIS

Activity: Soil Screening Operations

Analyzed By: Greg Clark

Reviewed By: Bruce Moe

Seaside MRS, Former Fort Ord

Activity Hazard Analysis – Soil Screening			
<i>Task</i>	<i>Potential Hazard(s)</i>	<i>Control Measure(s)</i>	<i>Personal Protective Clothing</i>
2) Heavy Equipment Operations	a) Heavy equipment hazards	<ul style="list-style-type: none"> • Only trained, authorized, qualified, and competent personnel will operate heavy equipment. • Owner’s manuals shall be with each piece of equipment in operation. • When equipment is used to load trucks, operators will remain in their cab with windows up and heater/air conditioner on. • Equipment will be inspected before each shift and documented (see attached checklist). • Equipment with serious safety hazards (problems with breaks, etc.) will immediately be taken out of service and repaired before used. • Operators are responsible for the equipment or trucks they operate. • Ground personnel and operators will be familiar with appropriate hand signals in the work area. • All personnel in the controlled area where heavy equipment is operating will wear high visibility vests or an equivalent as approved by the contractor. • Manufacturer’s safety and operations manual will be reviewed and followed. • Heavy equipment will be equipped with rollover protection and backup alarms. • Employees will remain at least 25 feet away from the back, front, or sides of heavy equipment during soil moving operations. • Equipment repair noted on the inspection sheet will be scheduled for maintenance during the shift first noted, as appropriate. 	Heavy Equipment Operators/Laborers – hard hat, safety glasses with side shields or goggles, steel-toe safety boots, reflective vests, ear protection, and leather/rubber/cotton gloves, as necessary.

ACTIVITY HAZARD ANALYSIS

Activity: Soil Screening Operations

Analyzed By: Greg Clark

Reviewed By: Bruce Moe

Seaside MRS, Former Fort Ord

Activity Hazard Analysis – Soil Screening			
<i>Task</i>	<i>Potential Hazard(s)</i>	<i>Control Measure(s)</i>	<i>Personal Protective Clothing</i>
2) Heavy Equipment Operations (continued)	b) Traffic flow/vehicle accidents	<ul style="list-style-type: none"> • The traffic truck/route plan will be followed. • When two-way traffic travels through intersections with poor visibility or short visibility, the speed limits will be slow enough to prevent accidents (15 miles per hour maximum while on-site), and/or flag personnel will be used to control traffic congestion. • Field foot traffic will be kept away from equipment/truck traffic to the extent possible. • Traffic patterns, traffic plans, and rights-of-way will be covered in safety meetings. 	Heavy Equipment Operators/Laborers – hard hat, safety glasses with side shields or goggles, steel-toe safety boots, reflective vests, ear protection, and leather/rubber/cotton gloves, as necessary.
	c) Dropped tools or supplies	<ul style="list-style-type: none"> • Steel-toe boots, high visibility reflective vests, safety glasses, and hardhat meeting ANSI standards will be worn in all construction areas. 	
	d) Eye injury due to flying particulate	<ul style="list-style-type: none"> • Safety glasses with side shields will be worn in all construction work areas. • If material gets into an employee's eye, the eye should immediately be flushed for 15 minutes at an emergency eye wash station. The UXOSO will be notified immediately whenever material gets in an eye. • An eye wash station shall be in the work area where work is to be accomplished. 	

ACTIVITY HAZARD ANALYSIS

Activity: Soil Screening Operations

Analyzed By: Greg Clark

Reviewed By: Bruce Moe

Seaside MRS, Former Fort Ord

Activity Hazard Analysis – Soil Screening			
<i>Task</i>	<i>Potential Hazard(s)</i>	<i>Control Measure(s)</i>	<i>Personal Protective Clothing</i>
2) Heavy Equipment Operations (continued)	e) Vehicular traffic in work area/Worker struck by vehicle	<ul style="list-style-type: none"> • High visibility vests shall be worn. • Heavy equipment and vehicles will have safety features (backup alarms), brakes, windows, and windshields in-place and maintained according to regulations and good practices. • Vehicle inspection program implemented, which inspects for safe operation and condition each shift before use. 	Heavy Equipment Operators/Laborers – hard hat, safety glasses with side shields or goggles, steel-toe safety boots, reflective vests, ear protection, and leather/rubber/cotton gloves, as necessary.
	f) Back injury from lifting heavy loads	<ul style="list-style-type: none"> • Site personnel will be instructed on proper lifting techniques. • Mechanical devices should be used to reduce manual handling of materials. • Employees will follow the WESTON requirement of not lifting more than 50 pounds or unusually awkward materials by themselves. Team lifting should be utilized if mechanical devices are not available. 	

ACTIVITY HAZARD ANALYSIS

Activity: Soil Screening Operations

Analyzed By: Greg Clark

Reviewed By: Bruce Moe

Seaside MRS, Former Fort Ord

Activity Hazard Analysis – Soil Screening			
<i>Task</i>	<i>Potential Hazard(s)</i>	<i>Control Measure(s)</i>	<i>Personal Protective Clothing</i>
2) Heavy Equipment Operations (continued)	g) Exposure to high noise and vibration from heavy equipment	<ul style="list-style-type: none"> • The UXOSO will determine the need for hearing protection and conduct monitoring if needed. Noise monitoring will be conducted for those activities involving difficulty communicating in a normal voice or at or above 85 dBA Sound Pressure Level. • All equipment will be equipped with manufacturer's required mufflers. 	Heavy Equipment Operators/Laborers – hard hat, safety glasses with side shields or goggles, steel-toe safety boots, reflective vests, ear protection, and leather/rubber/cotton gloves, as necessary.
	h) Biological hazards	<ul style="list-style-type: none"> • Insect repellent will be on hand for use to minimize the potential for infection with West Nile virus, as recommended in OSHA directives. • Use caution when walking in shrub areas. Snakes may be active. • Check for ticks when walking through vegetated areas. • An environmental/biological (California tiger salamander) briefing shall be given to all personnel in the area. • Coveralls/Tyvek will be available to help prevent the spread of poison oak oils, and 70% isopropyl alcohol spray will be used to decontaminate personnel and equipment. 	
	i) Unsafe conditions due to housekeeping	<ul style="list-style-type: none"> • Equipment, such as fire extinguishers and owners manuals, and other items in the cab of equipment and tractors will be secured. Trash and debris will be kept out of the cab to prevent debris from falling under the control pedals. The view out of the windows will remain unobscured by debris. 	

ACTIVITY HAZARD ANALYSIS

Activity: Soil Screening Operations

Analyzed By: Greg Clark

Reviewed By: Bruce Moe

Seaside MRS, Former Fort Ord

Activity Hazard Analysis – Soil Screening			
<i>Task</i>	<i>Potential Hazard(s)</i>	<i>Control Measure(s)</i>	<i>Personal Protective Clothing</i>
3) Mechanical Soil Screening Process	a) Vibratory Power Screen Operations	<ul style="list-style-type: none"> • Only qualified/authorized personnel shall operate Power Screen. • The UXOSO will determine the need for hearing protection and conduct monitoring if needed. Noise monitoring will be conducted for those activities involving difficulty communicating in a normal voice or at or above 85 dBA Sound Pressure Level. • All equipment will be equipped with manufacturer's required mufflers. • All screens and guards shall be in place to prevent personnel from entering or being caught inside machine. • The area around loading/unloading shall be kept clear of obstructions and Slip/Trip/Fall hazards. • When handling any metal debris, care shall be taken to prevent puncture/cuts from the sharp/irregular edges. • During the screening process, only qualified and authorized personnel shall handle MEC. • Safety technicians will monitor airborne dust levels in the work area. Airborne dust shall be suppressed by application of a water-based mist, as necessary, to keep levels below action level of 2.5 mg/m³. If particulate levels are at or above the action levels, additional wet methods will be used to reduce the dust levels. "No Visible Emissions Rule will be in effect." • All personnel shall know the emergency shutoff/Kill Switch locations and how to operate them. 	Heavy Equipment Operators/Laborers – hard hat, safety glasses with side shields or goggles, steel-toe safety boots, reflective vests, ear protection (single or double), and leather/rubber/cotton gloves, as necessary.

ACTIVITY HAZARD ANALYSIS

Activity: Soil Screening Operations

Analyzed By: Greg Clark

Reviewed By: Bruce Moe

Seaside MRS, Former Fort Ord

Activity Hazard Analysis – Soil Screening			
<i>Task</i>	<i>Potential Hazard(s)</i>	<i>Control Measure(s)</i>	<i>Personal Protective Clothing</i>
3) Mechanical Soil Screening Process (continued)	b) Conveyors	<ul style="list-style-type: none"> • Only qualified/authorized personnel shall operate Conveyors. • No maintenance shall be performed while the conveyor is in operation except when lubrication/adjustments are necessary while the conveyor needs to be in motion and only when all safeguards are in place and is done by experienced/trained maintenance personnel. • Inspect Emergency shutoff switches and all guards on the conveyor belt systems. All employees working on Power Screen Plant will have a thorough working knowledge of the Kill Switches and their locations. • Inspection, maintenance, and repairs will be in accordance with manufacturer's recommendations. • Where reversing, runaway, or uncontrolled lowering are potential hazards, anti-runaway devices, breaks, backstops, or other safeguards shall be installed. • Safety devices shall be arranged to operate in such a manner that, if a power failure or a failure of the device occurs, a hazardous condition would not result. • All take-up mechanisms (contact with cables, chains, belts) and nip and shear points shall be guarded. • Keep hands and all body parts away from moving parts and pinch points. • Riding on conveyors is prohibited. • The area around loading/unloading shall be kept clear of obstructions. 	Heavy Equipment Operators/Laborers – hard hat, safety glasses with side shields or goggles, steel-toe safety boots, reflective vests, ear protection (single or double), and leather/rubber/cotton gloves, as necessary.

ACTIVITY HAZARD ANALYSIS

Activity: Soil Screening Operations

Analyzed By: Greg Clark

Reviewed By: Bruce Moe

Seaside MRS, Former Fort Ord

Activity Hazard Analysis – Soil Screening			
<i>Task</i>	<i>Potential Hazard(s)</i>	<i>Control Measure(s)</i>	<i>Personal Protective Clothing</i>
3) Mechanical Soil Screening Process (continued)	b) Conveyors (continued)	<ul style="list-style-type: none">• Safety technicians will monitor airborne dust levels in the work area. Airborne dust shall be suppressed by application of a water-based mist, as necessary, to keep levels below action level of 2.5 mg/m³. If particulate levels are at or above the action levels, additional wet methods will be used to reduce the dust levels. “No Visible Emissions Rule will be in effect.”• Shutoff switches shall be tested and witnessed by the supervisor prior to starting work.	Heavy Equipment Operators/Laborers – hard hat, safety glasses with side shields or goggles, steel-toe safety boots, reflective vests, ear protection (single or double), and leather/rubber/cotton gloves, as necessary.

ACTIVITY HAZARD ANALYSIS

Activity: Oversize Reject Processing

Analyzed By/Date: Greg Clark

Reviewed By: Bruce Moe

Seaside MRA, Fort Ord

Activity Hazard Analysis – Oversize Reject Processing			
Task	Potential Hazard(s)	Control Measure(s)	Personal Protective Clothing
4) Mechanical Soil Processing <i>(continued)</i>	c) Oversize Reject Crusher Operations <i>(continued)</i>	<ul style="list-style-type: none"> • Only qualified/Authorized personnel shall operate Crusher Equipment. • Safety Officer or IH will determine the need for hearing protection and conduct monitoring if needed. Noise monitoring will be conducted for those activities involving difficulty communicating in a normal voice or at or above 85 dBA Sound Pressure Level. • All equipment will be equipped with manufacturer's required mufflers. • All screens and guards shall be in place to prevent personnel from entering or being caught inside machine. • The area around loading/unloading shall be kept clear of obstructions and Slip/Trip/Fall hazards. • When handling any of the metal debris care shall be taken to prevent puncture/cuts from the sharp/irregular edges. • During material crushing activities, only qualified and authorized personnel shall handle MEC hazards. • Safety technicians will monitor airborne dust levels in the work area. Airborne dust shall be suppressed by application of a water-based mist, as necessary, to keep levels below action level of 2.5 mg/m³. If particulate levels are at or above the action levels additional wet methods will be used to reduce the dust levels. "No Visible Emissions Rule will be in effect". 	Heavy Equipment Operators/Laborers – Tyvek, hard hat, safety glasses with side shields or goggles, steel toes safety boots, reflective vests, ear protection (single or double) and leather/rubber/cotton gloves, as necessary.

ACTIVITY HAZARD ANALYSIS

Activity: Oversize Reject Processing

Analyzed By/Date: Greg Clark

Reviewed By: Bruce Moe

Seaside MRA, Fort Ord

Activity Hazard Analysis – Oversize Reject Processing			
Task	Potential Hazard(s)	Control Measure(s)	Personal Protective Clothing
4) Mechanical Soil Processing <i>(continued)</i>	c) Oversize Reject Crusher Operations <i>(continued)</i>	<ul style="list-style-type: none"> • Inspection, maintenance and repairs will be in accordance with manufacturer’s recommendations. • Safety devices shall be arranged to operate in such a manner that if a power failure or a failure of the device occurs a hazardous condition would not result. • All take-up mechanisms, (contact with cables, chains, belts), nip and shear points shall be guarded. • Keep hands and all body parts away from moving parts and pinch points. • No maintenance shall be performed while the crusher equipment is in operation. • Practice lock-out / tag-out procedures for cleaning, inspection, and maintenance activities. • All heavy equipment performing loading operations shall be armored. • No ground personnel allowed within the applicable exclusion zone while the crusher equipment is in operation. <p><i>All personnel shall know the emergency shut off/Kill Switch location.</i></p> <p><i>Shut off switches shall be tested and witnessed by the SSO prior to starting work.</i></p>	Heavy Equipment Operators/Laborers – Tyvek, hard hat, safety glasses with side shields or goggles, steel toes safety boots, reflective vests, ear protection (single or double) and leather/rubber/cotton gloves, as necessary.

ACTIVITY HAZARD ANALYSIS

Activity: Soil Screening Operations

Analyzed By: Greg Clark

Reviewed By: Bruce Moe

Seaside MRS, Former Fort Ord

SIFTING PLANT DAILY SAFETY INSPECTION REPORT			
Contractor Inspector Signature:	Date:		
Complete one checklist each day.	Yes	No	N/A
1. Are only trained personnel lubricating or adjusting conveyor when in motion?			
2. Are Lockout and Tagout procedures being used? Safe access shall be provided to permit inspection, repair, and maintenance activities.			
3. When machinery or equipment is found to be unsafe or when a deficiency that affects the safe operation of equipment is observed, is the equipment immediately taken out of service and its use prohibited until unsafe conditions have been corrected?			
4. Is machinery operated only by designated personnel?			
5. Are safety devices arranged to operate in such a manner so that, in the event of a power failure or failure of the device, a hazardous condition would not result?			
6. Unless guarded by location, are those sections of conveyors that cannot be enclosed without impairing the function provided with warning signs or personnel barriers?			
7. In the absence of a guard specifically erected to protect personnel, are warning signs provided to restrict unauthorized personnel from entering such hazardous areas?			
8. Are all openings that a person could step into guarded or, where guarding is not practical, have warning signs been posted?			
9. Is all mechanized equipment shut down before and during refueling?			
10. Are personnel prohibited from working, passing under, or riding in the buckets, booms, or hoppers?			
11. Does the unit have a dry chemical or carbon dioxide fire extinguisher with a minimum rating of 5-B: C?			
12. Is there an effective warning alarm?			
13. Are all belts, gears, shafts, pulleys, sprockets, spindles, drums, flywheels, chains, or other reciprocating, rotating, or moving parts guarded?			

ACTIVITY HAZARD ANALYSIS

Activity: Soil Screening Operations

Analyzed By: Greg Clark

Reviewed By: Bruce Moe

Seaside MRS, Former Fort Ord

SIFTING PLANT DAILY SAFETY INSPECTION REPORT			
Contractor Inspector Signature:	Date:		
Complete one checklist each day.	Yes	No	N/A
14. Is protection against hot surfaces, exhausts, etc., provided?			
15. Are platforms, footwalks, steps, handholds, guardrails, and toe boards designed, constructed, and installed on machinery and equipment to provide safe footing and access ways?			
16. Are exhaust or discharges from equipment directed so they do not endanger persons or obstruct operator vision?			
17. Is the area around loading and unloading points kept clear of obstructions that could create a hazard?			
18. Is operator blast shielding (fragment protection) installed on equipment used to excavate/handle unscreened soil?			
Comments:			

This checklist is based on EM 385-1-1, dated 3 November 2003.

APPENDIX D

Daily Quality Control Inspection Report

**DAILY QUALITY CONTROL INSPECTION REPORT - SOIL SIFTING OPERATIONS
SEASIDE MRA
FORMER FORT ORD, CALIFORNIA**

Inspection Date:	
MRS Source Area (1, 2, 3, or 4):	

QC Inspection of Oversized Material (over 4 inches) from the feed hopper grizzly not fed to rock crusher (Material Type 1)			
Inspection Frequency	Time	Inspection	UXO Tech Signature
Morning		100% visual inspection performed for Munitions and Explosives of Concern and Munitions Debris (MEC/MD) (aided with magnetometer and all-metals detectors) of reject material not fed to rock crusher (due to large size or incompatible material type such as lumber, rubber, or wire). If MEC/MD item(s) found, notify the SUXOS immediately for proper management and document item(s) listed by Material Type in Comments Section of this form.	
Afternoon		100% visual inspection performed for Munitions and Explosives of Concern and Munitions Debris (MEC/MD) (aided with magnetometer and all-metals detectors) of reject material not fed to rock crusher (due to large size or incompatible material type such as lumber, rubber, or wire). If MEC/MD item(s) found, notify the SUXOS immediately for proper management and document item(s) listed by Material Type in Comments Section of this form.	

QC Inspection of > 3/8-inch and < 4-inch metal debris collected by the first magnet (Material Type 2)			
Inspection Frequency	Time	Inspection	UXO Tech Signature
Daily		100% visual inspection performed for MEC /MD of material recovered by Magnet #1. If item(s) found, notify the SUXOS immediately for proper management and document item(s) listed by Material Type in Comments Section of this form.	

**DAILY QUALITY CONTROL INSPECTION REPORT - SOIL SIFTING OPERATIONS
SEASIDE MRA
FORMER FORT ORD, CALIFORNIA**

QC Inspection of Debris items rejected by the 3/8-inch and 2-inch vibrating screen (Material Type 3)			
Inspection Frequency	Time	Inspection	UXO Tech Signature
Morning		100% visual inspection performed for MEC/MD (aided with magnetometer and all-metals detectors) of reject material. If item(s) found, notify the SUXOS immediately for proper management and document item(s) listed by Material Type in Comments Section of this form.	
Afternoon		100% visual inspection performed for MEC/MD (aided with magnetometer and all-metals detectors) of reject material. If item(s) found, notify the SUXOS immediately for proper management and document item(s) listed by Material Type in Comments Section of this form.	

QC Inspection of < 3/8-inch metal debris collected by the second magnet (Material Type 4)			
Inspection Frequency	Time	Inspection	UXO Tech Signature
Daily		100% visual inspection performed for MEC/MD of material recovered by Magnet #2. If item(s) found, notify the SUXOS immediately for proper management and document item(s) listed by Material Type in Comments Section of this form.	

QC Inspection of < 3/8-inch screened soil/final product (Material Type 5) and screen integrity			
Inspection Frequency	Time	Inspection	UXO Tech Signature
Morning		Randomly select and spread out approximately 15 cubic yards from the morning production stockpile (three loader buckets). Perform visual inspection (aided with magnetometer and all-metals detectors) of selected material for any metal items greater than 3/8 inch in size. If oversized metal item(s) found, notify the SUXOS immediately for direction and document item(s) listed by Material Type in Comments Section of this form. Note: The stockpile will be reprocessed if metal items greater than 3/8 inch in size are detected, and cause of failure will be determined prior to performing additional sifting.	
		Visually inspect the 2-inch and 3/8-inch screens for damage after shutdown.	

DAILY QUALITY CONTROL INSPECTION REPORT - SOIL SIFTING OPERATIONS
SEASIDE MRA
FORMER FORT ORD, CALIFORNIA

QC Inspection of < 3/8-inch screened soil/final product (Material Type 5) and screen integrity			
Afternoon		Randomly select and spread out approximately 15 cubic yards from the afternoon production stockpile (three loader buckets). Perform visual inspection (aided with magnetometer and all-metals detectors) of selected material for any metal items greater than 3/8 inch in size. If oversized metal item(s) found, notify the SUXOS immediately for direction and document item(s) listed by Material Type in Comments Section of this form. Note: The stockpile will be reprocessed if metal items greater than 3/8 inch in size are detected, and cause of failure will be determined prior to performing additional sifting.	
		Visually inspect the 2-inch and 3/8-inch screens for damage after shutdown.	

QC Inspection of < 1-inch rock crusher output (Material Type 6)			
Inspection Frequency	Time	Inspection	UXO Tech Signature
Minimum of Once a Day		Randomly select and spread out approximately 15 cubic yards from the morning production stockpile (three loader buckets). Perform visual inspection (aided with magnetometer and all-metals detectors) of selected material for any metal items greater than 1 inch in size. If oversized metal item(s) found, notify the SUXOS immediately for direction and document item(s) listed by Material Type in Comments Section of this form. Note: The stockpile will be reprocessed if material greater than 1 inch in size are detected, and cause of failure will be determined prior to performing additional sifting.	
		Visually inspect the rock crusher for damage after shutdown and verify appropriate discharge size setting.	
Minimum of Once a Day		Randomly select and spread out approximately 15 cubic yards from the morning production stockpile (three loader buckets). Perform visual inspection (aided with magnetometer and all-metals detectors) of selected material for any metal items greater than 1 inch in size. If oversized metal item(s) found, notify the SUXOS immediately for direction and document item(s) listed by Material Type in Comments Section of this form. Note: The stockpile will be reprocessed if material greater than 1 inch in size are detected, and cause of failure will be determined prior to performing additional sifting.	
		Visually inspect the rock crusher for damage after shutdown and verify appropriate discharge size setting.	

**DAILY QUALITY CONTROL INSPECTION REPORT - SOIL SIFTING OPERATIONS
SEASIDE MRA
FORMER FORT ORD, CALIFORNIA**

QC Seeding for Sifting Plant			
Inspection Frequency	Time	Inspection	UXO Tech Signature
Morning		Introduce the three seed items during the morning production run and inspect the magnet reject hoppers and (if necessary) the other oversized reject material after next shutdown to verify recovery of the seed items.	
Afternoon		Introduce the three seed items during the afternoon production run and inspect the magnet reject hoppers and (if necessary) the other oversized reject material after next shutdown to verify recovery of the seed items.	

QC Inspection of MEC and MD Storage and Non-MEC Scrap			
Inspection Frequency	Time	Inspection	UXO Tech Signature
Daily		Inspect MEC storage magazine to ensure that items are properly secured.	
Daily		Inspect MD containers to ensure that lids are secured and locked.	
Daily		Inspect Non-MEC scrap to ensure that it is properly segregated.	

**DAILY QUALITY CONTROL INSPECTION REPORT - SOIL SIFTING OPERATIONS
SEASIDE MRA
FORMER FORT ORD, CALIFORNIA**

MEC or MD Recovered by Material Type (attached separate sheet if needed):

Deficiencies Noted:

Corrective Actions Taken:

Other Comments:

DAILY QUALITY CONTROL INSPECTION REPORT - SOIL SIFTING OPERATIONS
SEASIDE MRA
FORMER FORT ORD, CALIFORNIA

UXO Supervisor Name

Signature

Date

UXO QC Manager Name

Signature

Date

APPENDIX E

Form 1348-1A, July 91 (EG)

DD FORM 1348-1A, JUL 91 (EG) ISSUE RELEASE/RECEIPT DOCUMENT

1	2	3	4	5	6	7	8	9	10	11	12	13	14	15	16	17	18	19	20	21	22	23	24	25	26	27	28	29	30	31	32	33	34	35	36	37	38	39	40	41	42	43	44	45	46	47	48	49	50	51	52	53	54	55	56	57	58	59	60	61	62	63	64	65	66	67	68	69	70	71	72	73	74	75	76	77	78	79	80
D I S T R I B U T I O N										S U P P L I E R										D O C U M E N T																																																											
UNIT QUANTITY										SUPPLEMENTARY ADDRESS										DISPOSITION																																																											
UNIT										ADDRESS										TRIBUTION																																																											
FROM										ADDRESS										PROJECT																																																											
SHIP FROM										ADDRESS										PROJECT																																																											
SHIP TO										ADDRESS										PROJECT																																																											
FORMER FORT ORD, SEASIDE MRA										FORMER FORT ORD, INLAND RANGE																																																																					
MARK FOR ROAD BASE																																																																															
DOC DATE										NMFC										FRT RATE																																																											
TYPE CARGO										PS																																																																					
CITY REC'D										UNIT WEIGHT										UNIT CUBE																																																											
NO CONT										TOTAL WEIGHT										TOTAL CUBE																																																											
RECEIVED BY										DATE RECEIVED																																																																					
ITEM NOMENCLATURE										Non-ferrous 1--inch minus material																																																																					
FREIGHT CLASSIFICATION NOMENCLATURE																																																																															
TOTAL PRICE										DOLLARS										CTS																																																											
UNIT PRICE										DOLLARS										CTS																																																											

24. DOCUMENT NUMBER & SUFFIX (30-44)

25. NATIONAL STOCK NO. & ADD (6-22)

26. RIC (4-6) LI (23-24) QTY (25-29) CON CODE (71) DIST (55-58) UP (74-80)

27. ADDITIONAL DATA

This certifies and verifies that the material presented herein has been 100% inspected and to the best of our knowledge and belief, are inert and/or free of explosives or related materials.

Certifying UXO Technician Name _____ Date _____

Certifying UXO Technician Signature _____ Date _____

Verifying UXO Technician Name _____ Date _____

Verifying UXO Technician Signature _____ Date _____